

BREAKOVER DIODES

A range of glass-passivated bidirectional breakover diodes in the TO-220AC outline, available in a $\pm 12\%$ tolerance series of nominal breakover voltage. Their controlled breakover voltage and peak current handling capability together with the high holding current make them suitable for transient overvoltage protection in applications such as telephony equipment or other data transmission lines, and remote instrumentation lines.

QUICK REFERENCE DATA

		BR210—100 to 280		
Breakover voltage	$V_{(BQ)}$	nom.	100 to 280	V
Holding current	I_H	>	150	mA
Transient peak current (10/320 μ s impulse)	I_{TSM}	max.	40	A ←

MECHANICAL DATA

Dimensions in mm

Fig.1 TO-220AC

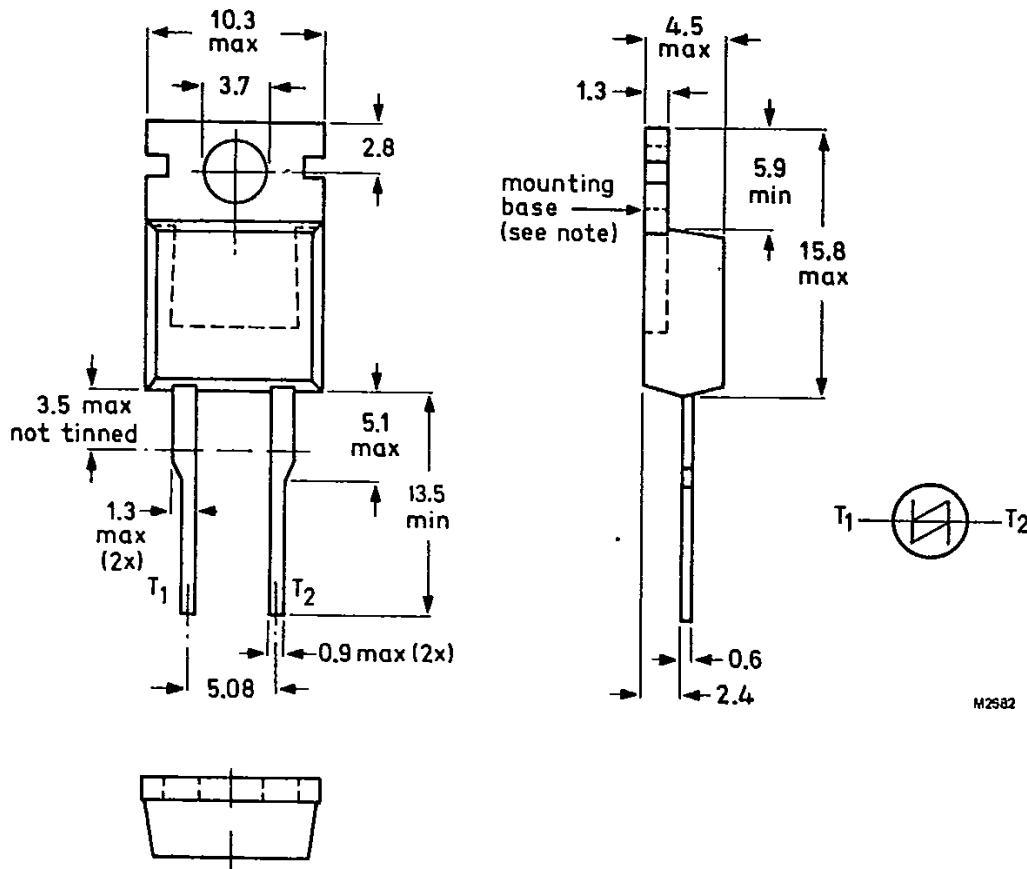

Net mass: 2 g

Note: The exposed metal mounting base is directly connected to terminal T_1 .

Accessories supplied on request: see data sheet Mounting instructions and accessories for TO-220 envelopes.

RATINGS

Limiting values in accordance with the Absolute Maximum System (IEC 134).

Voltages (either direction)

			BR210-100 to 280	
→ Continuous voltages	V_D	max.	75% of nom. voltage	-
→ Currents				
(in either direction)				
Transient peak current (8/20 μ s impulse)	I_{TSM1}	max.	150	A
Transient peak current (10/320 μ s impulse) equivalent to 10/700 μ s 1.6 kV voltage impulse (CCITT K17); (see Fig.4)	I_{TSM2}	max.	40	A
Average on-state current (averaged over any 20 ms period); up to $T_{mb} = 75^\circ\text{C}$	$I_{T(AV)}$	max.	5	A
RMS AC on-state current	$I_{T(RMS)}$	max.	8	A
Non-repetitive peak on-state current, $T_j = 100^\circ\text{C}$ prior to surge; $t = 10$ ms; half sinewave	I_{TSM3}	max.	30	A
$I^2 t$ for fusing ($t = 10$ ms)	$I^2 t$	max.	4.5	A^2s
Rate of rise of on-state current after $V_{(BO)}$ turn-on ($t_p = 10 \mu\text{s}$)	di/dt	max.	50	$\text{A}/\mu\text{s}$
Power dissipation				
Continuous dissipation; unidirectional operation, device mounted on infinite heatsink	P_{tot}	max.	40	W
Peak dissipation; $t = 1$ ms, free-air mounting	P_{TM}	max.	400	W
Temperatures				
Storage temperature	T_{stg}		-40 to +150	$^\circ\text{C}$
Operating temperature (off-state)	T_j	max.	125	$^\circ\text{C}$
Overload temperature (on-state)	T_{vj}	max.	150	$^\circ\text{C}$

THERMAL RESISTANCE

From junction to ambient in free air
mounted on a printed circuit board
at any lead length

$$R_{th\ j-amb} = 60\ K/W$$

From junction to mounting base
bidirectional operation
unidirectional operation

$$R_{th\ j-mb} = 2.5\ K/W$$

$$R_{th\ j-mb} = 3.1\ K/W$$

Transient thermal impedance ($t = 1\ ms$)

$$Z_{th\ j-mb} = 0.3\ K/W$$

Influence of mounting method

1. Heatsink-mounted with clip (see mounting instructions)

Thermal resistance from mounting base to heatsink

a. with heatsink compound

$$R_{th\ mb-h} = 0.3\ K/W$$

b. with heatsink compound and 0.06 mm maximum
mica insulator

$$R_{th\ mb-h} = 1.4\ K/W$$

c. with heatsink compound and 0.1 mm max.
mica insulator (56369)

$$R_{th\ mb-h} = 2.2\ K/W$$

d. with heatsink compound and 0.25 mm max.
alumina insulator (56367)

$$R_{th\ mb-h} = 0.8\ K/W$$

e. without heatsink compound

$$R_{th\ mb-h} = 1.4\ K/W$$

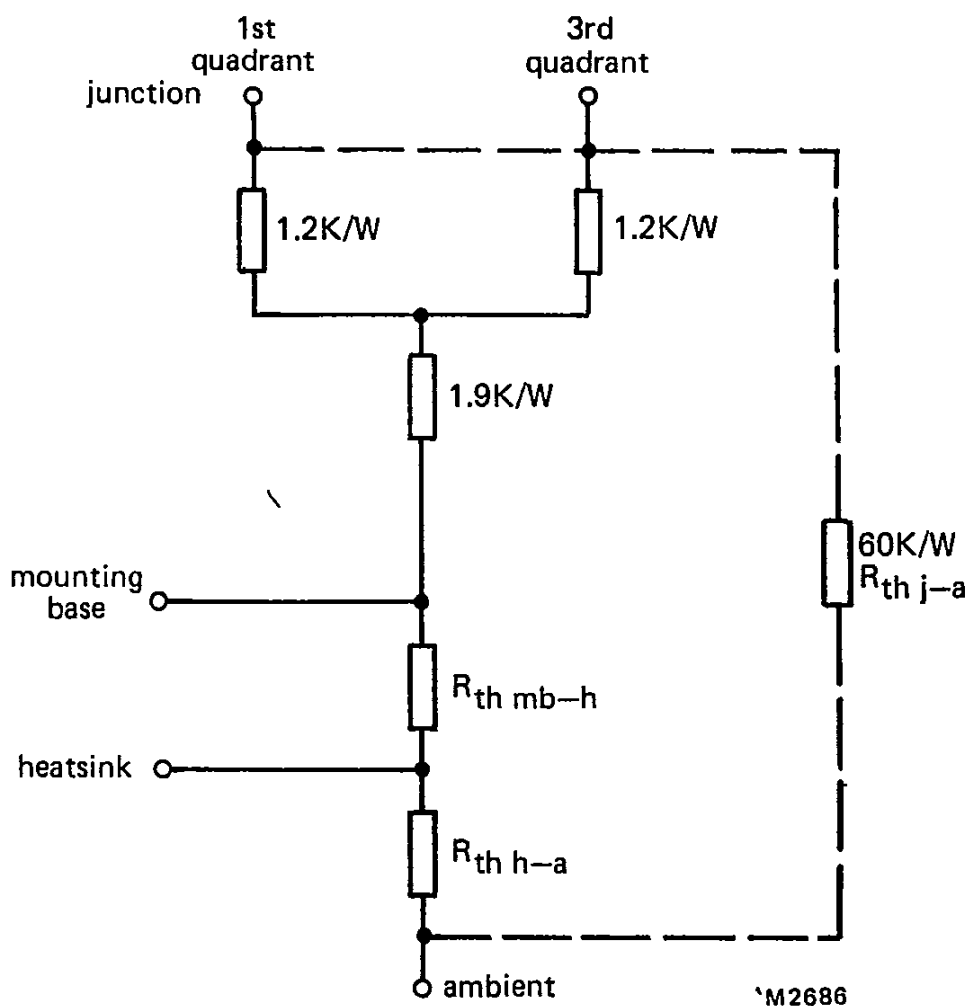

Fig.2 Components of thermal resistance (junction to ambient).

CHARACTERISTICS $T_j = 25\text{ }^\circ\text{C}$ unless otherwise stated

Voltages and currents (in either direction)

On-state voltage (note 1)

 $I_{TM} = 5\text{ A}$ $V_{TM} < 2.5\text{ V}$ Avalanche voltage $V_{(BR)}$; ($I_{(BR)} = 10\text{ mA}$), andBreakover voltage $V_{(BO)}$; ($I \leq I_S$):(100 μs pulsed)

	$V_{(BR)}$ min.	$V_{(BO)}$ max.	
BR210-100	88	112	V
-120	105	135	V
-140	123	157	V
-160	140	180	V
-240	211	269	V
-260	228	292	V
-280	246	314	V

Temperature coefficient of $V_{(BR)}$ $S_{(br)} \text{ typ. } +0.1\text{ \%}/\text{K}$

Holding current (note 2)

 $T_j = 25\text{ }^\circ\text{C}$ $I_H > 150\text{ mA}$ $T_j = 70\text{ }^\circ\text{C}$ $I_H > 100\text{ mA}$

Switching current (note 3)

(100 μs pulsed) $I_S > 10\text{ mA}$ $I_S \text{ typ. } 200\text{ mA}$ $I_S < 1000\text{ mA}$ Off-state current; $V_D = 85\% V_{(BR)\text{min}}$ (note 4) $T_j = 70\text{ }^\circ\text{C}$ $I_D < 50\text{ }\mu\text{A}$ $T_j = 125\text{ }^\circ\text{C}$ $I_D < 250\text{ }\mu\text{A}$ Linear rate of rise of off-state voltage
that will not trigger any device; $T_j = 70\text{ }^\circ\text{C}$; $V_{DM} = 85\% V_{(BR)\text{min}}$ $dV_D/dt < 2000\text{ V}/\mu\text{s}$

Off-state capacitance

 $V_D = 0$; $f = 1\text{ kHz}$ to 1 MHz $C_j < 300\text{ pF}$ **Notes:**

1. Measured under pulsed conditions to avoid excessive dissipation.
2. The minimum current at which the BOD will remain in the on-state.
3. The avalanche current required to switch the BOD to the on-state.
4. I.e., at maximum recommended continuous voltage.

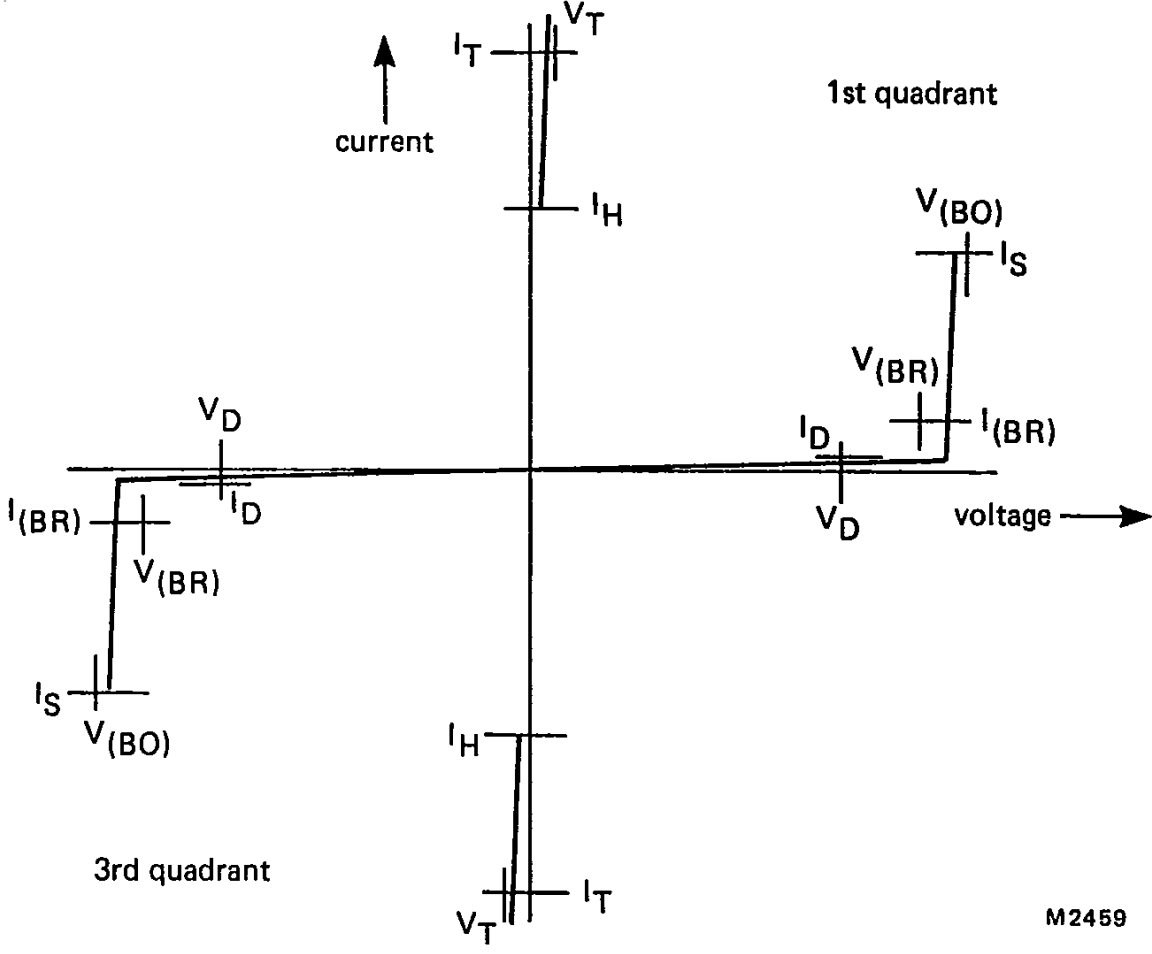

Fig.3 Breakover diode characteristics.

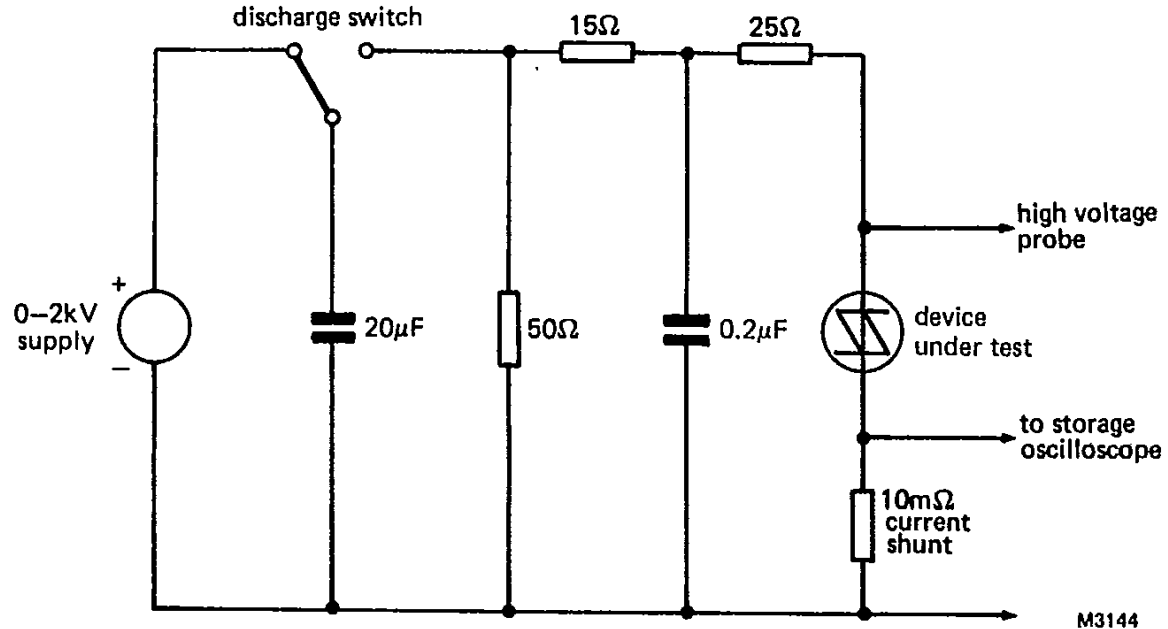

Fig.4 Test circuit for high voltage impulse (I_{TSM2})
(according to CCITT vol IX-Rec. K17)

Notes:

The 10/700 μ s Impulse Waveform is defined for the voltage across the test fixture when the device under test is replaced with an open circuit. Clearly, once a breakover device has switched on to a low voltage, the current waveform will have a shorter fall-time, since the $15 \Omega + 25 \Omega$ output impedance becomes effectively in parallel with the 50Ω .

MOUNTING INSTRUCTIONS

1. The device may be soldered directly into the circuit. The maximum permissible soldering temperature is 275 °C. Heat must not be applied for more than 5 seconds. Soldered joints must be at least 4.7 mm from the body of the device.
2. The leads must not be bent less than 2.4 mm from the body of the device and should be supported during bending. The leads can be bent twisted or straightened by 90° maximum. The minimum bending radius is 1 mm.
3. Any heatsink used must have a flatness in the mounting area of 0.02 mm maximum per 10 mm. Mounting holes must be deburred.
4. For good thermal contact a metallic-oxide loaded heatsink compound must be used between the mounting base and heatsink. Ordinary silicone grease is not recommended.
5. The preferred mounting method is with the use of a spring clip. This ensures good thermal contact under the crystal area and safe isolation. However, if a screw is used, it should be M3 cross-recess pan-head. Care should be taken to avoid damage to plastic body of the device during mounting.
- 6. Rivet mounting (only possible for non-insulated mounting).
Devices may be rivetted to flat heatsinks; such a process must neither deform the mounting tab, nor enlarge the mounting hole. The maximum recommended hole size for rivet mounting is 3.5 mm. The pre-formed head of the rivet should be on the device side and any rivet tool used should not damage the plastic body of the device.

OPERATING NOTES

1. For most applications involving transient overvoltage protection only, the device is not normally mounted on a heatsink. The free-air rating of the device is normally adequate for non-repetitive transients.
2. Circuit connections to the T1 terminal should be made to the left-hand lead not the mounting tab.
3. During a mains contact fault, excessive dissipation can occur with the device held in its avalanche state. The following figures illustrate how power dissipation can be calculated during a mains contact fault. In general, if the fault resistance is about 500 – 5 kΩ, there may be excessive dissipation.

MAINS CONTACT

Calculation of power dissipation during mains contact fault.

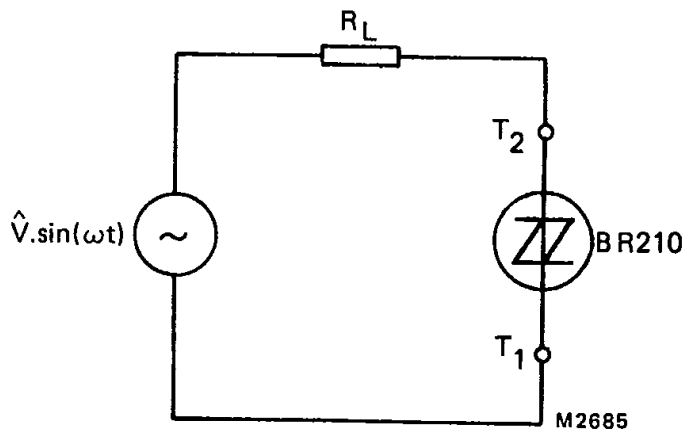

Fig.5 Equivalent circuit of BOD during mains contact fault;
 R_L = total fault resistance.

M3069

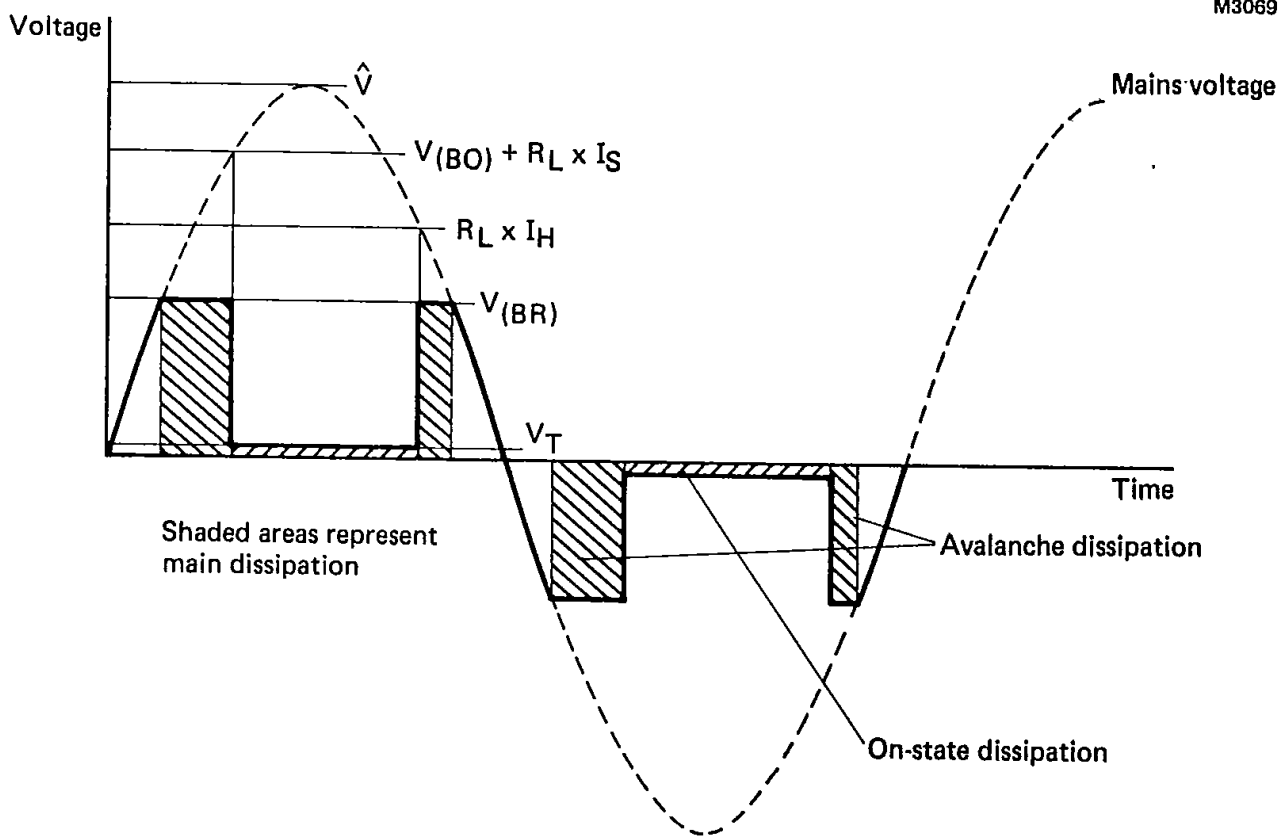

Fig.6 Dissipation during mains contact fault.

Solid line shows voltage across BOD.

Total power generated = avalanche dissipation prior to switching
 (per half-cycle) + on-state dissipation
 + avalanche dissipation after on-state.

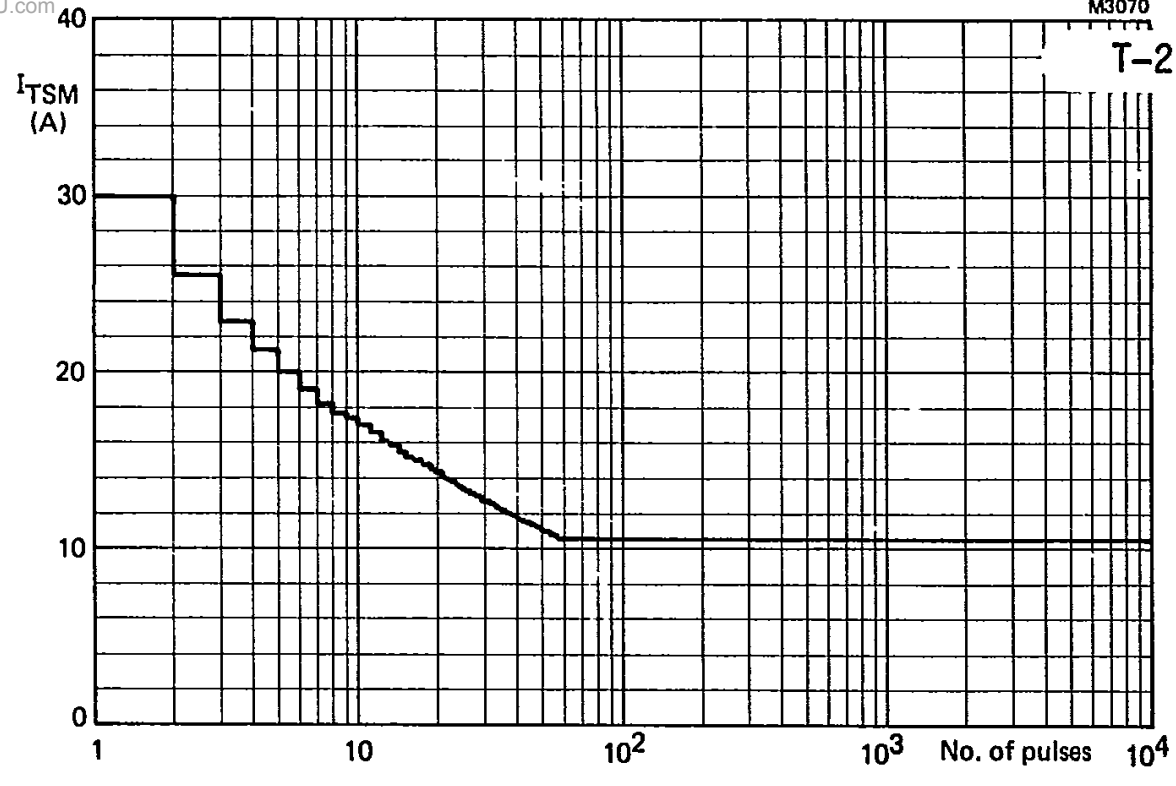

Fig.7 Maximum permissible non-repetitive on-state current based on sinusoidal currents ($f = 50$ Hz; device triggered at the start of each pulse). $T_j = 125$ °C prior to surge.

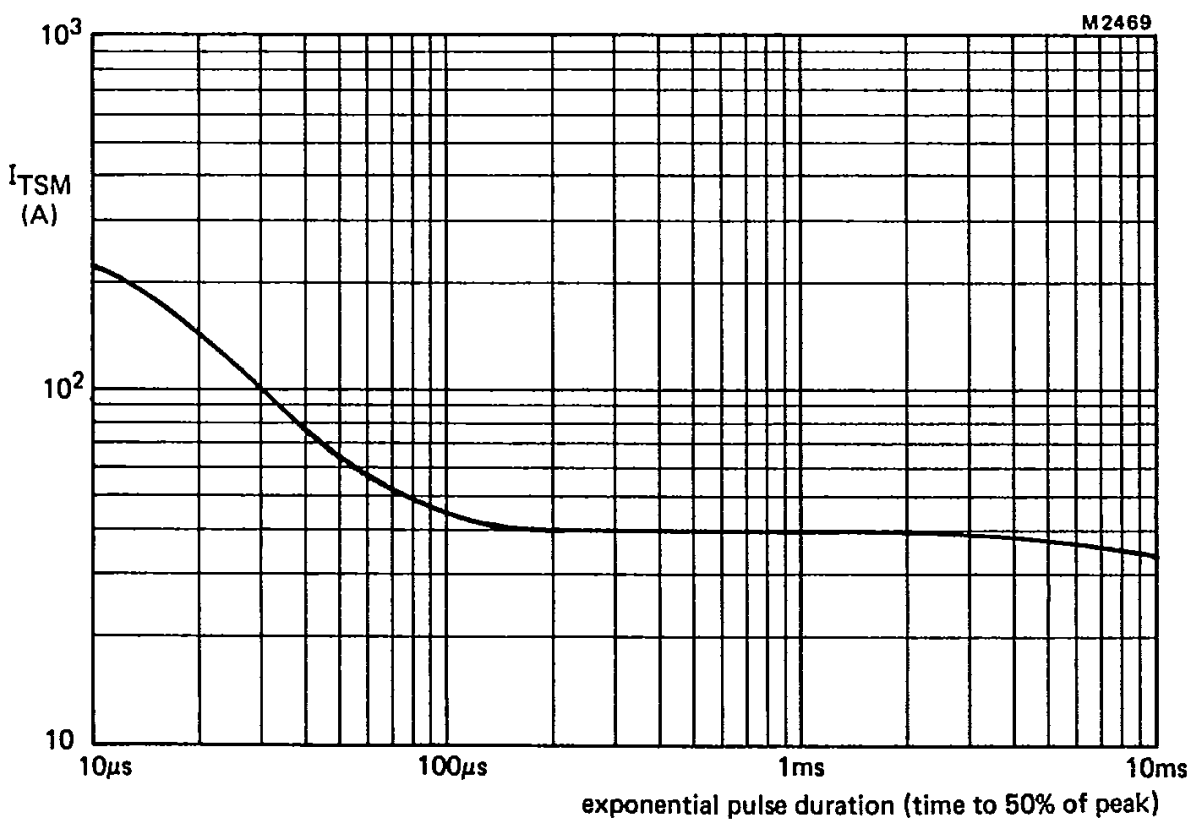
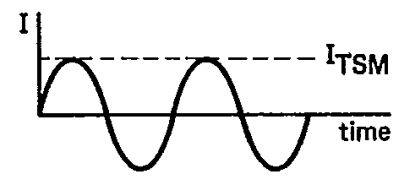

Fig.8 Maximum non-repetitive exponential waveform Impulse Current rating as a function of pulse duration (virtual front-time 10 μ s).

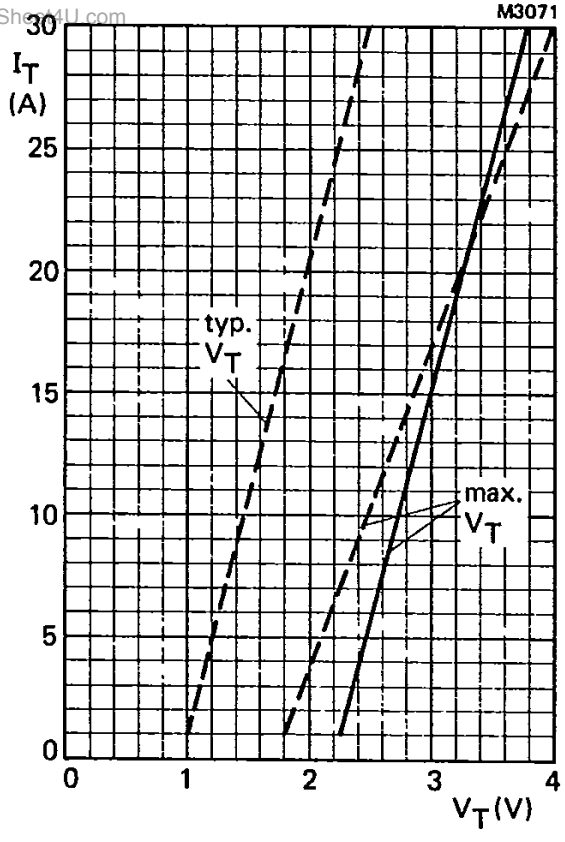

Fig.9 On-state voltage as a function of on-state current. (200 μ s pulsed condition to avoid excessive dissipation)
 — $T_j = 25$, - - - $T_j = 125$ $^{\circ}$ C.

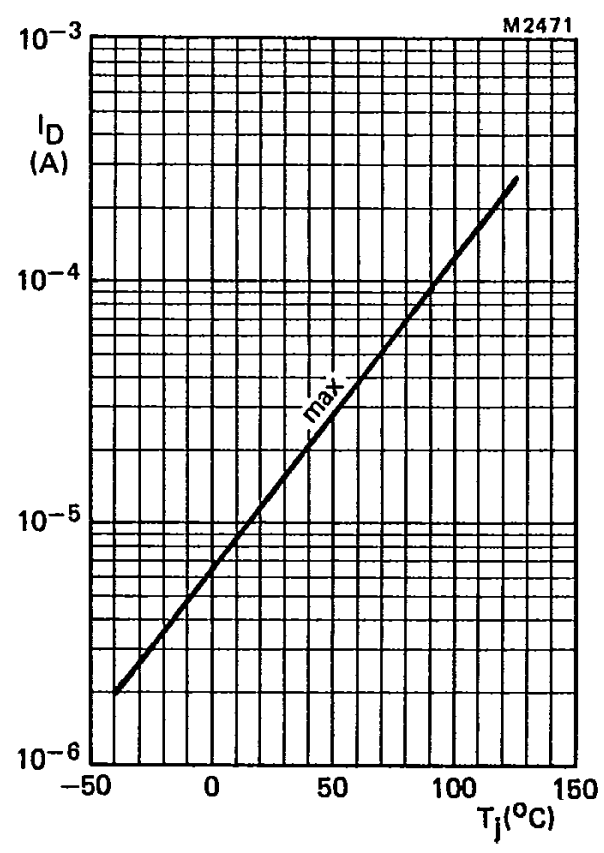

Fig.10 Maximum off-state current as a function of temperature.

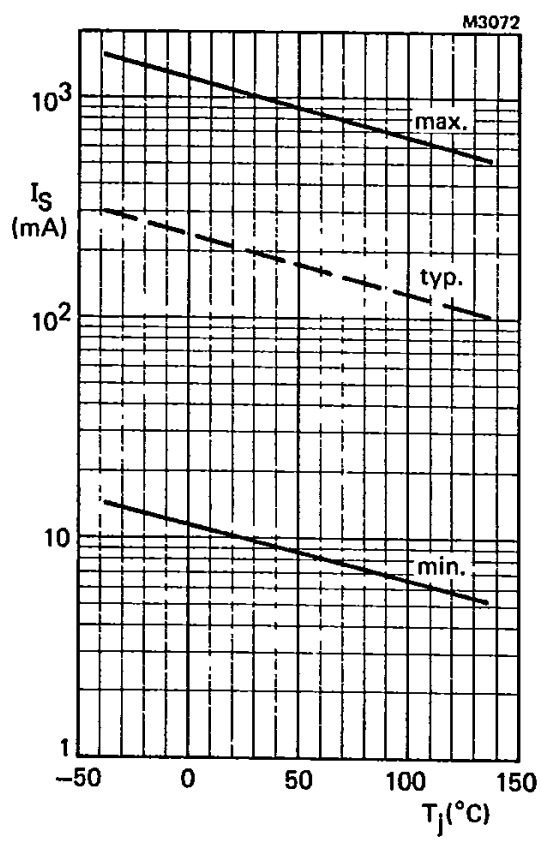

Fig.11 Switching current as a function of junction temperature.

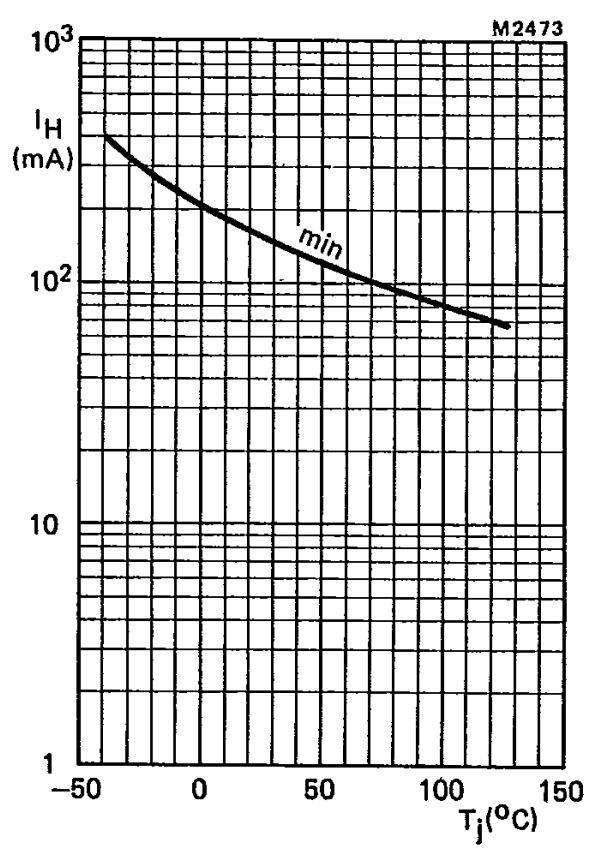

Fig.12 Minimum holding current as a function of temperature.

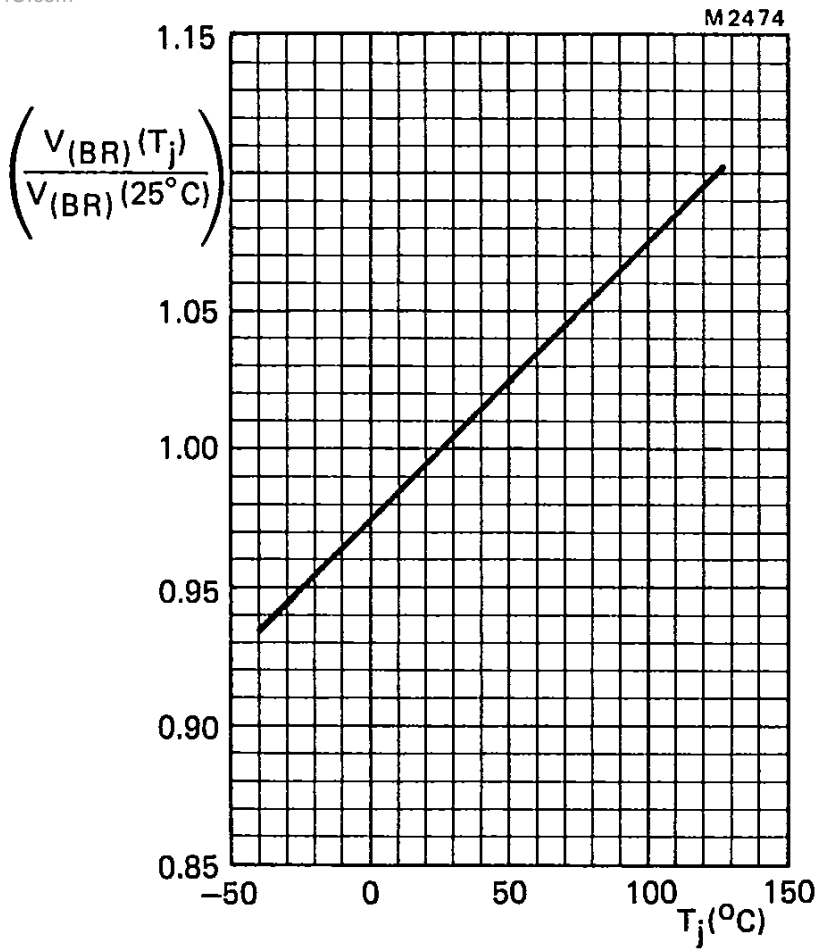

Fig.13 Normalised avalanche breakdown voltage as a function of temperature. Note: this figure may also be used to derive normalised $V_{(BO)}$.

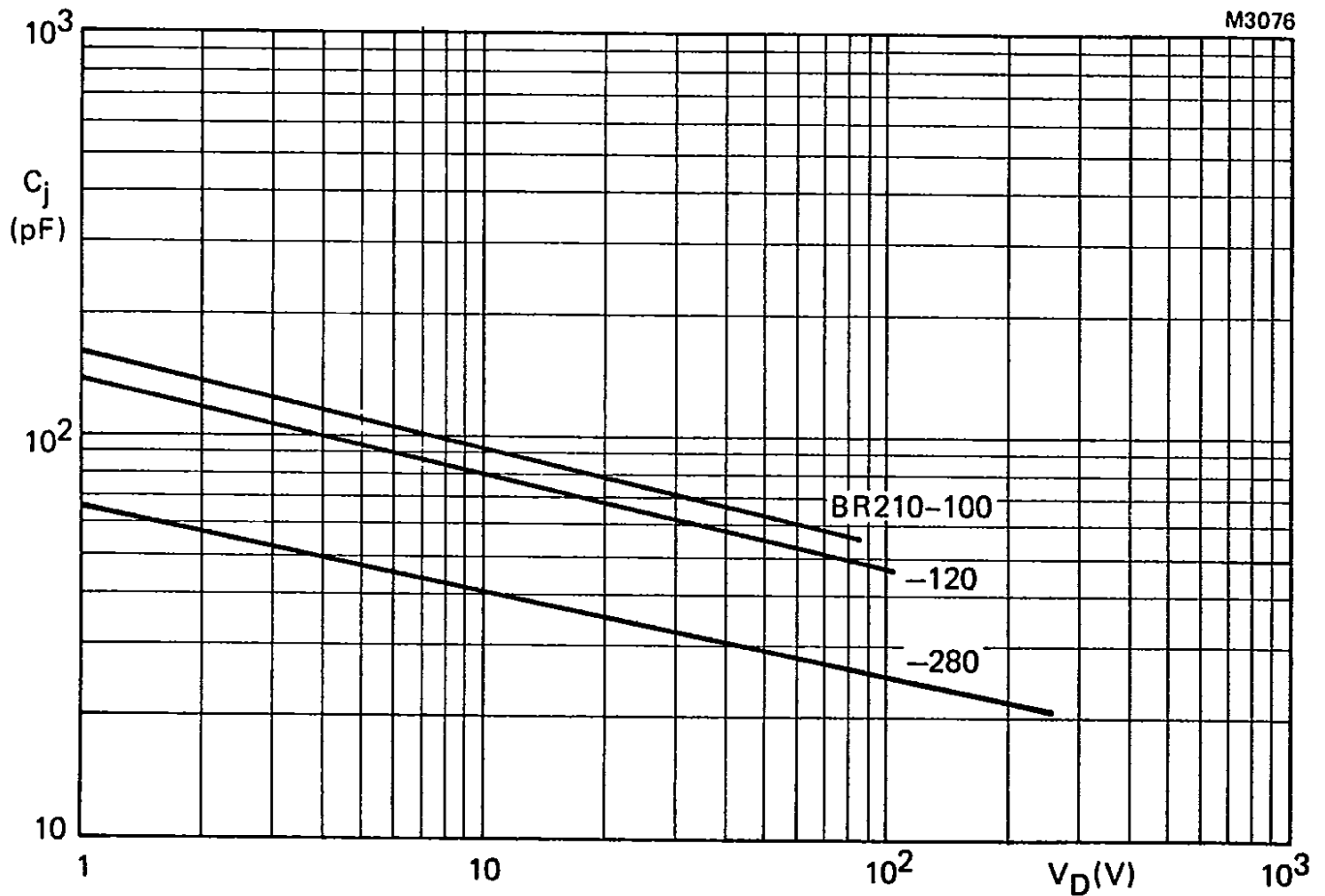

Fig.14 Typical junction capacitance as a function of off-state voltage; $T_j = 25^\circ\text{C}$; $f = 1\text{ MHz}$.

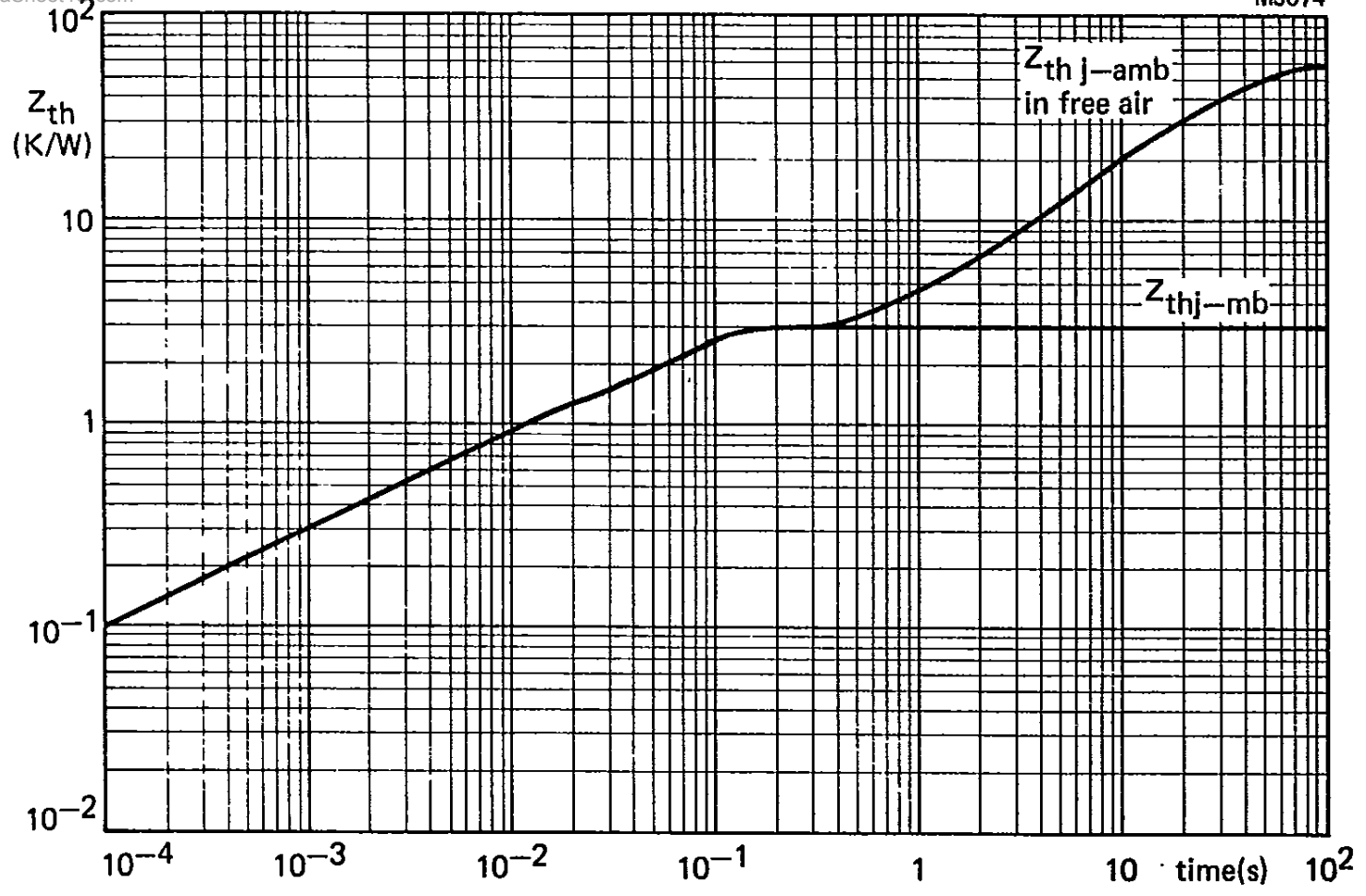

Fig.15 Transient thermal impedance as a function of time (rectangular pulse duration).