

High Efficiency Step-Down DC/DC Converters with Internal Schottky Diode

FEATURES

- **High Efficiency: Up to 94%**
- Usable in Noise-Sensitive Products
- Peak Inductor Current Independent of Inductor Value
- Short-Circuit Protection
- **Internal Low Forward Drop Schottky Diode**
- **Only Three External Components Required**
- Wide V_{IN} Range: 4V to 18.5V (Absolute Maximum)
- Low Dropout Operation
- Low-Battery Detector
- Pin Selectable Current Limit
- Internal 0.9Ω Power Switch: $V_{IN} < 11V$
- Standby Current: $130\mu A$
- Active Low Micropower Shutdown

APPLICATIONS

- Inverting Converters
- Step-Down Converters
- Memory Backup Supply
- Portable Instruments
- Battery-Powered Equipment
- Distributed Power Systems

LT and LTC are registered trademarks and LT is a trademark of Linear Technology Corporation.

DESCRIPTION

The LTC[®]1574 is a family of easy-to-use current mode DC/DC converters ideally suited for 9V to 5V, 5V to 3.3V and inverting operation. With an internal 0.9Ω switch (at a supply voltage of 12V) and a low forward drop Schottky diode ($0.450V$ typ at $200mA$, $T_A = 25^\circ C$), the LTC1574 requires only three external components to construct a complete high efficiency DC/DC converter.

Under no load condition, the LTC1574 draws only $130\mu A$. In shutdown, it draws a mere $2\mu A$ making this converter ideal for battery-powered applications. In dropout, the internal P-channel MOSFET switch is turned on continuously allowing the user to maximize the life of the battery source.

The maximum inductor current of the LTC1574 family is pin selectable to either $340mA$ or $600mA$, optimizing efficiency for a wide range of applications. Operation up to $200kHz$ permits the use of small surface mount inductors and capacitors.

For applications requiring higher output current or ultra-high efficiency, see the LTC1148 or LTC1265 data sheets. For detailed applications information, see the LTC1174 data sheet.

TYPICAL APPLICATION

High Efficiency Step-Down Converter

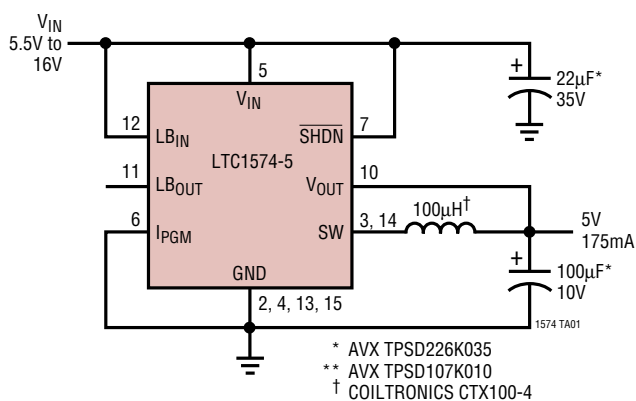

LTC1574-5 Efficiency

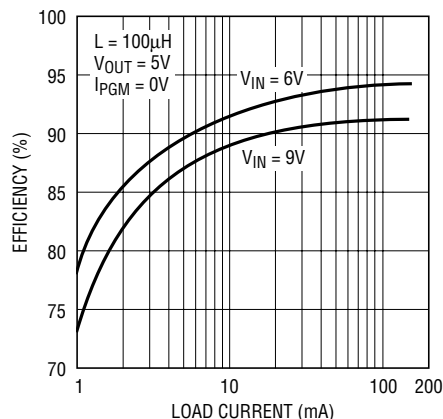

1574 TA02

ABSOLUTE MAXIMUM RATINGS

(Note 1)

(Voltage Referred to GND Pin)

Input Supply Voltage (Pin 5)	-0.3V to 18.5V
Switch Current (Pin 3, 14)	1A
Switch Voltage (Pin 3, 14)	$V_{IN} - 18.5V$
Operating Temperature Range	0°C to 70°C
Junction Temperature (Note 2)	125°C
Storage Temperature Range	-65°C to 150°C
Lead Temperature (Soldering, 10 sec)	300°C

PACKAGE/ORDER INFORMATION

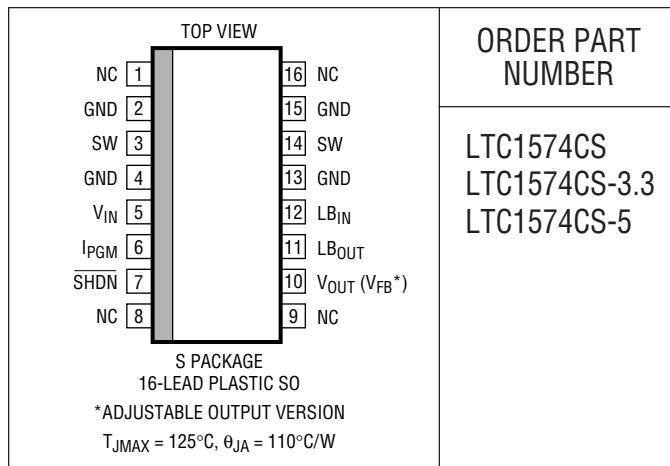

ORDER PART NUMBER

LTC1574CS
LTC1574CS-3.3
LTC1574CS-5

Consult factory for Industrial and Military grade parts.

ELECTRICAL CHARACTERISTICS

The ● denotes specifications which apply over the full operating temperature range, otherwise specifications are at $T_A = 25^\circ\text{C}$. $V_{IN} = 9V$, $SHDN = V_{IN}$, $I_{PGM} = 0V$, unless otherwise specified.

SYMBOL	PARAMETER	CONDITIONS	MIN	TYP	MAX	UNITS	
I_{FB}	Feedback Current into Pin 10	LTC1574			1	μA	
V_{FB}	Feedback Voltage	LTC1574	● 1.20	1.25	1.30	V	
V_{OUT}	Regulated Output Voltage	LTC1574-3.3	● 3.14	3.30	3.46	V	
		LTC1574-5	● 4.75	5.00	5.25	V	
ΔV_{OUT}	Output Voltage Line Regulation	$V_{IN} = 6V$ to $12V$, $I_{LOAD} = 100\text{mA}$, $I_{PGM} = V_{IN}$ (Note 3)			10	70	mV
		LTC1574-3.3 (Note 3)	$20\text{mA} < I_{LOAD} < 175\text{mA}$, $I_{PGM} = 0V$		-5	-70	mV
			$20\text{mA} < I_{LOAD} < 400\text{mA}$, $I_{PGM} = V_{IN}$		-45	-70	mV
LTC1574-5 (Note 3)	$20\text{mA} < I_{LOAD} < 175\text{mA}$, $I_{PGM} = 0V$		-5	-70	mV		
	$20\text{mA} < I_{LOAD} < 400\text{mA}$, $I_{PGM} = V_{IN}$		-50	-70	mV		
I_Q	Input DC Supply Current (Note 4) Active Mode Sleep Mode Shutdown (Note 5)	$4V < V_{IN} < 16V$, $I_{PGM} = 0V$		450	600	μA	
		$4V < V_{IN} < 16V$		130	180	μA	
		$SHDN = 0V$, $4V < V_{IN} < 16V$		2	25	μA	
V_{LBTRIP}	Low-Battery Trip Point			1.25	1.4	V	
I_{LBIN}	Current into Pin 12				0.5	μA	
I_{LBOUT}	Current Sunk by Pin 11	$V_{LBOUT} = 0.4V$, $V_{LBIN} = 0V$		0.5	1.0	1.5	mA
		$V_{LBOUT} = 5V$, $V_{LBIN} = 10V$				1.0	μA
V_{HYST}	Comparator Hysteresis		7.5	15	30	mV	
I_{PEAK}	Current Limit	$I_{PGM} = V_{IN}$, $V_{OUT} = 0V$		● 0.54	0.60	0.78	A
		$I_{PGM} = 0V$, $V_{OUT} = 0V$		● 0.27	0.34	0.50	A
R_{ON}	ON Resistance of Switch		●	0.9	1.55	Ω	
t_{OFF}	Switch Off Time	V_{OUT} at Regulated Value		3	4	5	μs
V_{IH}	\overline{SHDN} Pin High	Minimum Voltage at Pin 7 for Device to Be Active		1.2		V	
V_{IL}	\overline{SHDN} Pin Low	Maximum Voltage at Pin 7 for Device to Be in Shutdown			0.75	V	

ELECTRICAL CHARACTERISTICS

The ● denotes specifications which apply over the full operating temperature range, otherwise specifications are at $T_A = 25^\circ\text{C}$. $V_{IN} = 9\text{V}$, $\overline{\text{SHDN}} = V_{IN}$, $I_{PGM} = 0\text{V}$, unless otherwise specified.

SYMBOL	PARAMETER	CONDITIONS	MIN	TYP	MAX	UNITS
I_{IH}	$\overline{\text{SHDN}}$ Pin Input Current	$\overline{\text{SHDN}} = 16\text{V}$			2	μA
I_{IL}	$\overline{\text{SHDN}}$ Pin Input Current	$0 \leq \overline{\text{SHDN}} \leq 0.8\text{V}$			0.5	μA
V_F	Schottky Diode Forward Voltage	Forward Current = 200mA		0.450	0.570	V
I_R	Schottky Reverse Current	Reverse Voltage = 5V Reverse Voltage = 18.5V		10 100	25 250	μA μA

Note 1: Absolute Maximum Ratings are those values beyond which the life of a device may be impaired.

Note 2: T_J is calculated from the ambient temperature T_A and power dissipation P_D according to the following formulas:

$$T_J = T_A + (P_D \cdot 110^\circ\text{C/W})$$

Note 3: Guaranteed by design.

Note 4: Does not include Schottky reverse current. Dynamic supply current is higher due to the gate charge being delivered at the switching frequency.

Note 5: Current into Pin 5 only, measured without electrolytic input capacitor.

TYPICAL PERFORMANCE CHARACTERISTICS

Efficiency vs Load Current

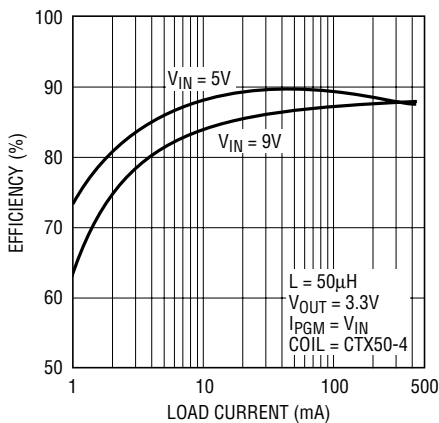

Efficiency vs Load Current

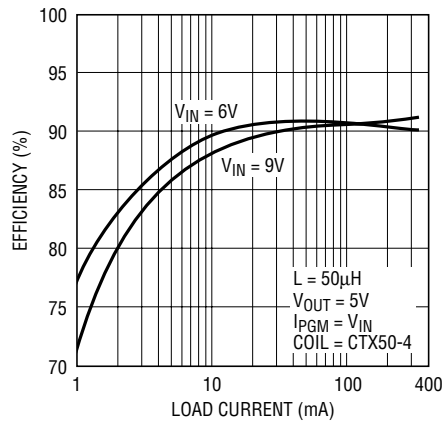

Efficiency vs Input Voltage

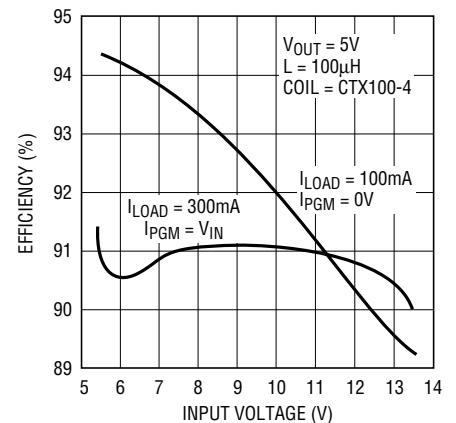

Efficiency Using Different Types of Inductor Core Material

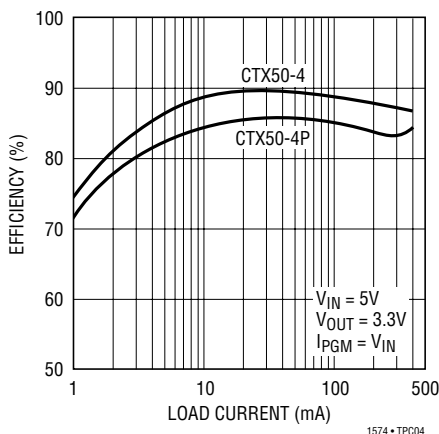

Switch Leakage Current vs Temperature

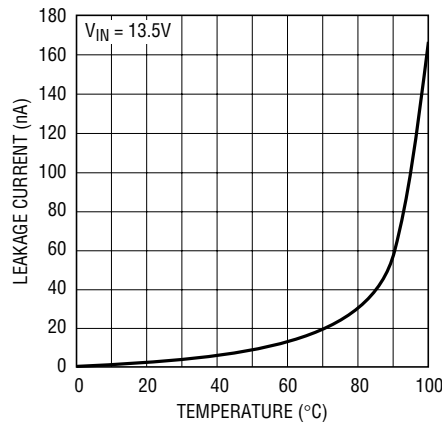

Switch Resistance vs Input Voltage

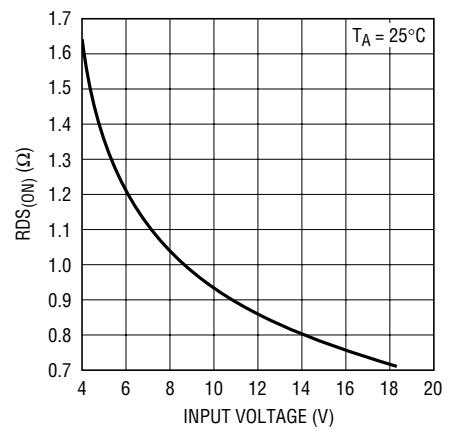

PIN FUNCTIONS

NC (Pins 1, 8, 9, 16): No Connection.

GND (Pins 2, 4, 13, 15): Ground.

SW (Pins 3, 14): Drain of P-Channel MOSFET Switch and Cathode of Schottky Diode.

V_{IN} (Pin 5): Input Supply Voltage. It must be decoupled close to ground (Pin 4).

I_{PGM} (Pin 6): This pin selects the current limit of the P-channel switch. With I_{PGM} = V_{IN}, the current trip point is 600mA and with I_{PGM} = 0V, the current trip point is reduced to 340mA.

SHDN (Pin 7): Pulling this pin to ground keeps the internal switch off and puts the LTC1574 in micropower shutdown.

V_{OUT} or V_{FB} (Pin 10): For the LTC1574, this pin connects to the main voltage comparator input. On the LTC1574-5 and LTC1574-3.3, this pin goes to an internal resistive divider which sets the output voltage.

LB_{OUT} (Pin 11): Open drain of an N-Channel Pull-Down. This pin will sink current when (Pin 12) LB_{IN} goes below 1.25V.

LB_{IN} (Pin 12): The (–) Input of the Low-Battery Voltage Comparator. The (+) input is connected to a reference voltage of 1.25V.

APPLICATIONS INFORMATION

Operating Frequency and Inductor

Since the LTC1574 utilizes a constant off-time architecture, its operating frequency is dependent on the value of V_{IN}. The frequency of operation can be expressed as:

$$f = \frac{1}{t_{OFF}} \left(\frac{V_{IN} - V_{OUT}}{V_{IN} + V_D} \right) \quad (\text{Hz})$$

where t_{OFF} = 4μs and V_D is the voltage drop across the internal Schottky diode. Note that the operating frequency is a function of the input and output voltage.

Although the size of the inductor does not affect the frequency or inductor peak current, it does affect the ripple current. The peak-to-peak ripple current is given by:

$$I_{RIPPLE} = 4 \cdot 10^{-6} \left(\frac{V_{OUT} + V_D}{L} \right) \quad (A_{P-P})$$

When choosing a small inductor, core loss will increase due to higher ripple current. Therefore, a low ESR output capacitor has to be used.

Short-Circuit Protection

The LTC1574 is protected from output short circuits by its internal current limit. Depending on the condition of the

I_{PGM} pin, the limit is either set to 340mA or 600mA. In addition, the off-time of the switch is increased to allow the inductor current to decay far enough to prevent any current build-up (see Figure 1).

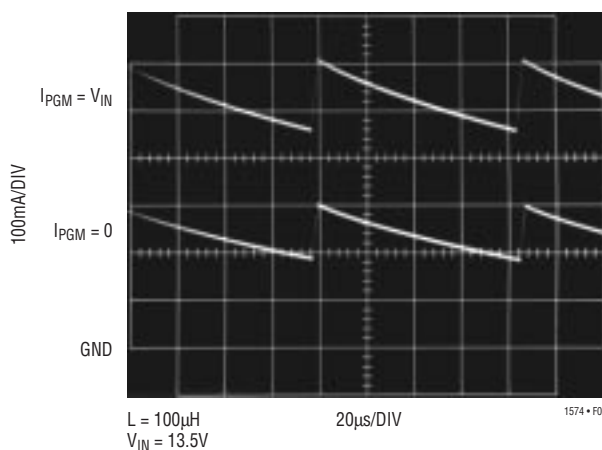

Figure 1. Inductor Current with Output Shorted

Low-Battery Detector

The low-battery indicator senses the input voltage through an external resistive divider. This divided voltage connects to the “–” input of a voltage comparator (Pin 12) which is compared with a 1.25V reference voltage. With the current

APPLICATIONS INFORMATION

going into Pin 12 being negligible, the following expression is used for setting the trip limit:

$$V_{LBTRIP} = 1.25 \left(1 + \frac{R4}{R3} \right)$$

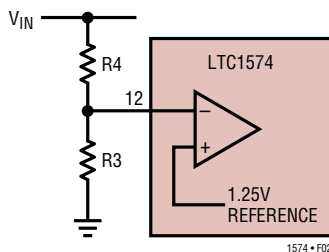

Figure 2. Low-Battery Comparator

LTC1574 Adjustable Applications

The LTC1574 develops a 1.25V reference voltage between the feedback terminal (Pin 10) and ground (see Figure 3). By selecting resistor R1, a constant current is caused to flow through R1 and R2 to set the overall output voltage. The regulated output voltage is determined by:

$$V_{OUT} = 1.25 \left(1 + \frac{R2}{R1} \right)$$

For most applications, a 30k resistor is suggested for R1. To prevent stray pickup, a 100pF capacitor is suggested across R1 located close to the LTC1574.

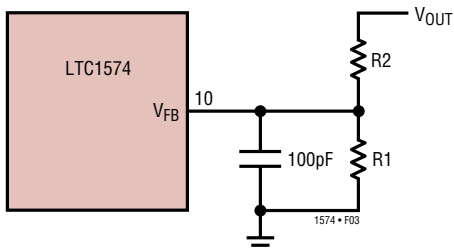

Figure 3. LTC1574 Adjustable Configuration

Inverting Applications

The LTC1574 can easily be set up for a negative output voltage. If -5V is desired, the LTC1574-5 is ideal for this application as it requires the least components. Figure 4 shows the schematic for this application. Note that the output voltage is now taken off the GND pins. Therefore, the maximum input voltage is now determined by the

difference between the absolute maximum voltage rating and the output voltage. A maximum of 12V is specified in Figure 4, giving the circuit 1.5V of headroom for V_{IN} . Note that the circuit can operate from a minimum of 4V, making it ideal for a four NiCd cell application. For a higher output current circuit, please refer to the Typical Applications section.

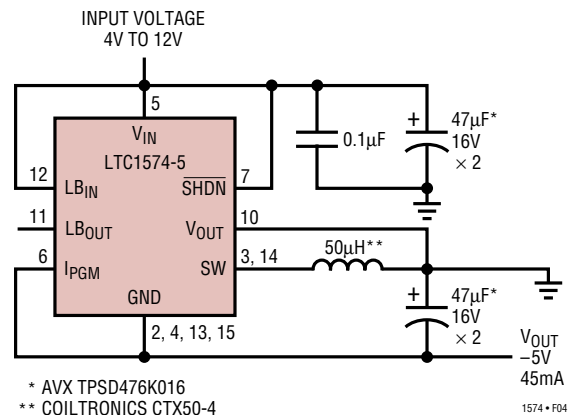

Figure 4. Positive-to-Negative 5V Converter

Low Noise Regulators

In some applications it is important not to introduce any switching noise within the audio frequency range. Due to the nature of the LTC1574 during Burst Mode™ operation, there is a possibility that the regulator will introduce audio noise at some load currents. To circumvent this problem, a feed-forward capacitor can be used to shift the noise spectrum up and out of the audio band. Figure 5 shows the low noise connection with C2 being the feed-forward capacitor. The peak-to-peak output ripple is reduced to 30mV over the entire load range. A toroidal surface mount

Burst Mode is a trademark of Linear Technology Corporation

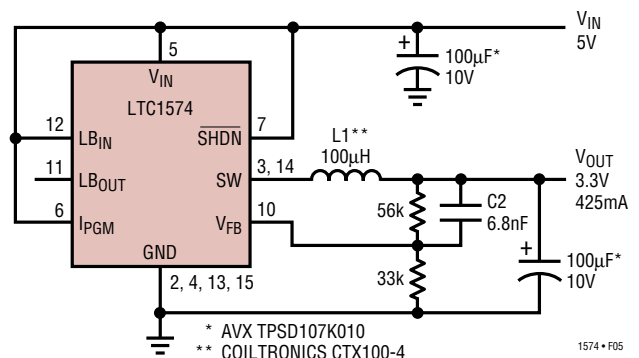

Figure 5. Low Noise 5V to 3.3V Regulator

APPLICATIONS INFORMATION

inductor L1 is chosen for its excellent self-shielding properties. Open magnetic structures such as drum and rod cores are to be avoided since they inject high flux levels into their surroundings. This can become a major source of noise in any converter circuit.

Design Example

As a design example, assume $V_{IN} = 9V$ (nominal), $V_{OUT} = 5V$ and $I_{OUT} = 350mA$ maximum. The LTC1574-5 is used for this application with I_{PGM} (Pin 6) connected to V_{IN} . The minimum value of L is determined by assuming the LTC1574-5 is operating in continuous mode.

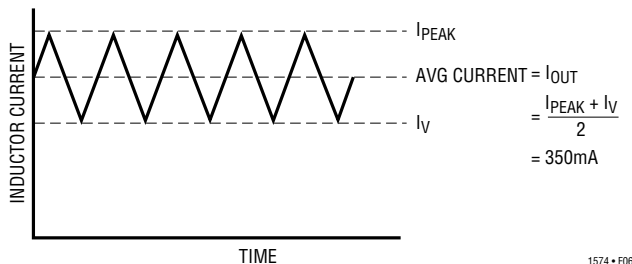

Figure 6. Continuous Inductor Current

With $I_{OUT} = 350mA$ and $I_{PEAK} = 0.6A$ ($I_{PGM} = V_{IN}$), $I_V = 0.1A$. The peak-to-peak ripple inductor current, I_{RIPPLE} , is $0.5A$ and is also equal to:

$$I_{RIPPLE} = 4 \cdot 10^{-6} \left(\frac{V_{OUT} + V_D}{L} \right) (A_{P-P})$$

Solving for L in the above equation and with $V_D = 0.5V$, $L = 44\mu H$. The next higher standard value of L is $50\mu H$ (example: Coiltronics CTX50-4). The operating frequency, ignoring voltage across diode V_D is:

$$f \approx 2.5 \cdot 10^5 \left(1 - \frac{V_{OUT}}{V_{IN}} \right)$$

$$= 111kHz$$

With the value of L determined, the requirements for C_{IN} and C_{OUT} are calculated. For C_{IN} , its RMS current rating should be at least:

$$I_{RMS} = \frac{I_{OUT} \left[V_{OUT} (V_{IN} - V_{OUT}) \right]^{1/2}}{V_{IN}} (A_{RMS})$$

$$= 174mA$$

For C_{OUT} , the RMS current rating should be at least:

$$I_{RMS} \approx \frac{I_{PEAK}}{2} (A_{RMS})$$

$$= 300mA$$

Absolute Maximum Ratings and Latchup Prevention

The absolute maximum ratings specify that SW (Pins 3, 14) can never exceed V_{IN} (Pin 5) by more than $0.3V$. Normally this situation should never occur. It could, however, if the output is held up while the supply is pulled down. A condition where this could potentially occur is when a battery is supplying power to an LTC1574 regulator and also to one or more loads in parallel with the the regulator's V_{IN} . If the battery is disconnected while the LTC1574 regulator is supplying a light load and one of the parallel circuits is a heavy load, the input capacitor of the LTC1574 regulator could be pulled down faster than the output capacitor, causing the absolute maximum ratings to be exceeded. The result is often a latchup which can be destructive if V_{IN} is reapplied. Battery disconnect is possible as a result of mechanical stress, bad battery contacts or use of a lithium-ion battery with a built-in internal disconnect. The user needs to assess his/her application to determine whether this situation could occur. If so, additional protection is necessary.

Prevention against latchup can be accomplished by simply connecting a Schottky diode across the SW and V_{IN} pins as shown in Figure 7. The diode will normally be reverse biased unless V_{IN} is pulled below V_{OUT} at which time the diode will clamp the $(V_{OUT} - V_{IN})$ potential to less than the $0.6V$ required for latchup. Note that a low leakage Schottky should be used to minimize the effect

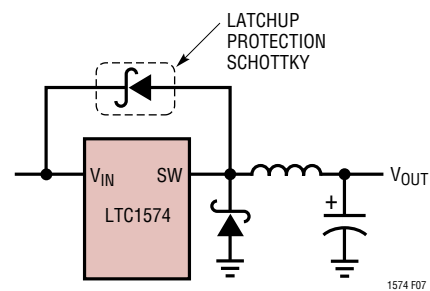

Figure 7. Preventing Absolute Maximum Ratings from Being Exceeded

APPLICATIONS INFORMATION

on no-load supply current. Schottky diodes such as MBR0530, BAS85 and BAT84 work well. Another more serious effect of the protection diode leakage is that at no load with nothing to provide a sink for this leakage current, the output voltage can potentially float above the

maximum allowable tolerance. To prevent this from occurring, a resistor must be connected between V_{OUT} and ground with a value low enough to sink the maximum possible leakage current.

TYPICAL APPLICATIONS

Low Noise, High Efficiency 3.3V Regulator

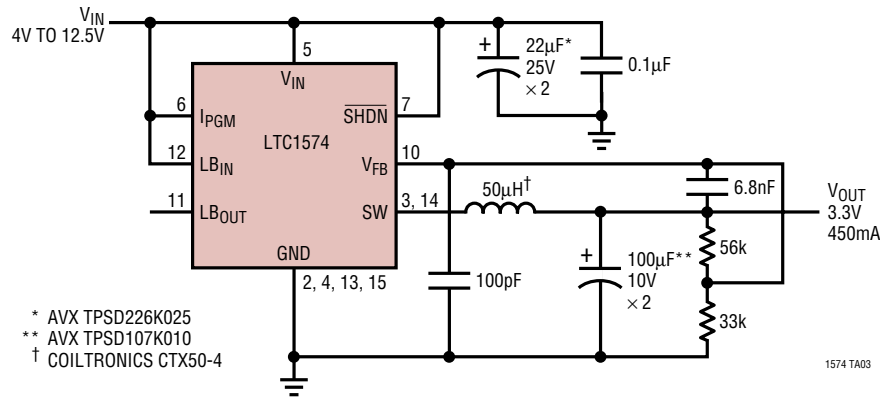

PACKAGE DESCRIPTION

Dimension in inches (millimeters) unless otherwise noted.

S Package
16-Lead Plastic Small Outline (Narrow 0.150)
(LTC DWG # 05-08-1610)

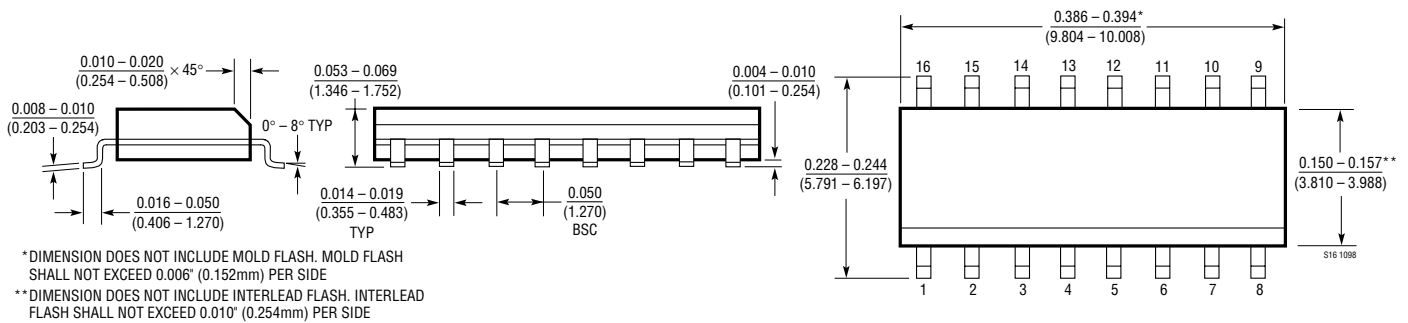

LTC1574

LTC1574-3.3/LTC1574-5

TYPICAL APPLICATIONS

Low Dropout 5V Step-Down Regulator with Low-Battery Detection

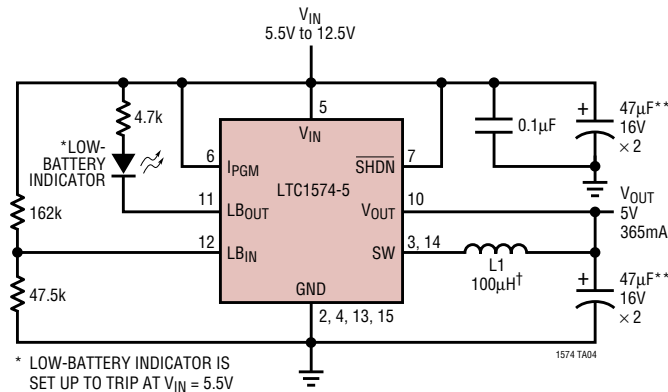

* LOW-BATTERY INDICATOR IS SET UP TO TRIP AT $V_{IN} = 5.5V$
 ** AVX TPSD476K016

† SELECTION

MANUFACTURER	PART NO.	TYPE
COILTRONICS	CTX100-4	SURFACE MOUNT
SUMIDA	CD75-101	SURFACE MOUNT
GOWANDA	GA10-103K	THROUGH HOLE

High Efficiency 3.3V Regulator

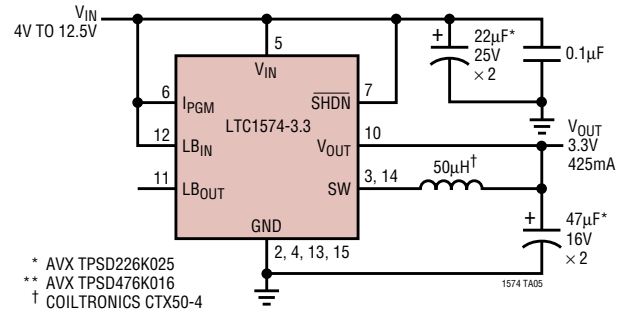

* AVX TPSD226K025
 ** AVX TPSD476K016
 † COILTRONICS CTX50-4

Positive to -5V Converter

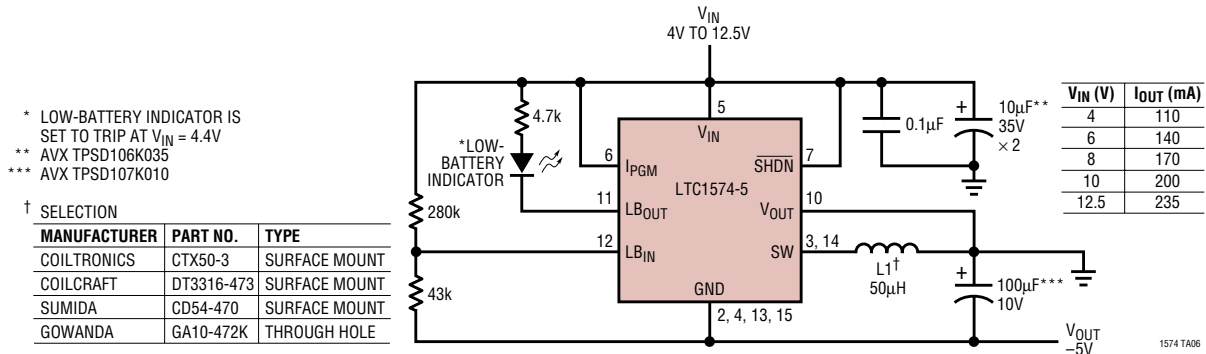

* LOW-BATTERY INDICATOR IS SET TO TRIP AT $V_{IN} = 4.4V$
 ** AVX TPSD106K035
 *** AVX TPSD107K010

† SELECTION

MANUFACTURER	PART NO.	TYPE
COILTRONICS	CTX50-3	SURFACE MOUNT
COILCRAFT	DT3316-473	SURFACE MOUNT
SUMIDA	CD54-470	SURFACE MOUNT
GOWANDA	GA10-472K	THROUGH HOLE

RELATED PARTS

PART NUMBER	DESCRIPTION	COMMENTS
LT [®] 1074/LT1076	Step-Down Switching Regulator	100kHz, 5A (LT1074) or 2A (LT1076) Monolithic
LTC1147	High Efficiency Step-Down DC/DC Controller	8-Pin Controller
LTC1174	High Efficiency Step-Down and Inverting DC/DC Converter	0.5A, Burst Mode Operation, SO-8 Package, V_{IN} to 18V
LTC1265	1.2A High Efficiency Step-Down DC/DC Regulator	Burst Mode Operation, Monolithic
LT1375/LT1376	1.5A 500kHz Step-Down Switching Regulator	High Frequency Small Inductor
LT1611	Inverting 1.4MHz Switching Regulator in SOT-23	-5V at 150mA from 5V Input, 1mV _{P-P} Output Ripple, SOT-23 Package
LTC1701	1MHz Step-Down DC/DC Converter in SOT-23	$V_{IN} = 2.5V$ to 5.5V, $I_Q = 135\mu A$, $V_{OUT} = 5V$ to 1.25V
LTC1707	High Efficiency Synchronous Step-Down Regulator	$V_{IN} = 2.85V$ to 8.5V, Selectable Burst Mode Operation, 600mA Output Current, SO-8 Package
LTC1877/LTC1878	High Efficiency Synchronous Step-Down Regulator	600mA at $V_{IN} = 5V$, 2.65V to 10V = V_{IN} , $I_Q = 10\mu A$