



MC4556

LINEAR INTEGRATED CIRCUIT

DUAL OPERATIONAL AMPLIFIER

DESCRIPTION

The UTC MC4556 integrated circuit is a high-gain, high output current dual operational amplifier capable of driving $\pm 70\text{mA}$ into 150Ω loads ($\pm 10.5\text{V}$ output voltage), and operating low supply voltage ($V+/V- = \pm 2\text{V}$).

The UTC MC4556 combines many of the features of the popular UTC MC4558 as well as having the capability of driving 150Ω loads. In addition, the wide band-width, low noise, high slew rate and low distortion of the UTC MC4556 make it ideal for many audio, telecommunications and instrumentation applications.

FEATURES

- * Operating Voltage $(\pm 2\text{V} \sim \pm 18\text{V})$
- * High Output Current $(I_{\text{OUT}} = 70\text{mA})$
- * Slew Rate $(3\text{V} / \mu\text{s typ.})$
- * Gain Band Width Product (8MHz typ.)
- * Bipolar Technology

ORDERING INFORMATION

Ordering Number		Package	Packing
Normal	Lead Free		
MC4556-D08-T	MC4556L-D08-T	DIP-8	Tube
MC4556-S08-R	MC4556L-S08-R	SOP-8	Tape Reel
MC4556-S08-T	MC4556L-S08-T	SOP-8	Tube

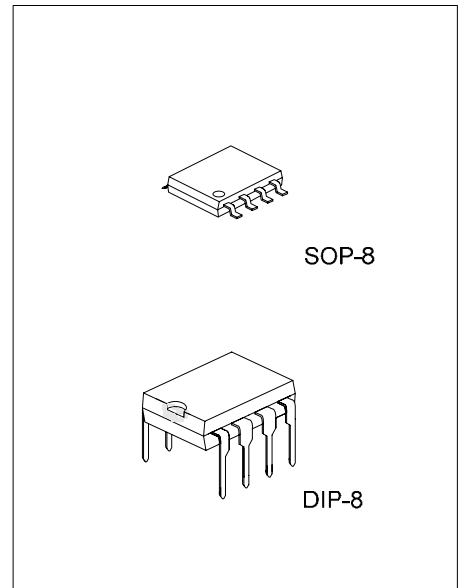

*Pb-free plating product number: MC4556L

<p>MC4556L-D08-T</p> <p>(1) Packing Type (2) Package Type (3) Lead Plating</p>	<p>(1) T: Tube, R: Tape Reel (2) D08: DIP-8, S08: SOP-8 (3) L: Lead Free Plating, Blank: Pb/Sn</p>
--	--

■ PIN CONFIGURATION

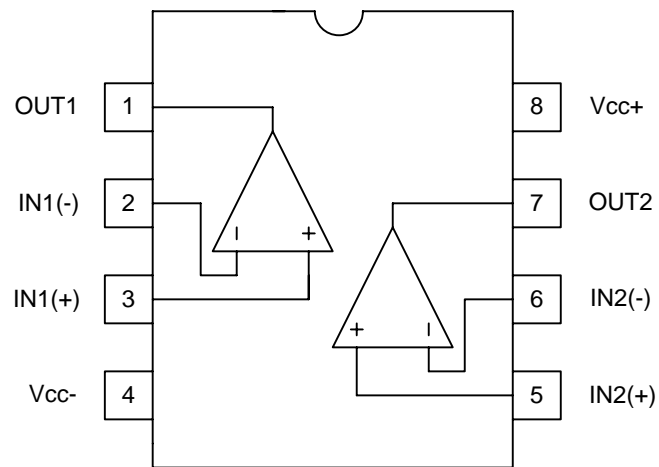

■ BLOCK DIAGRAM

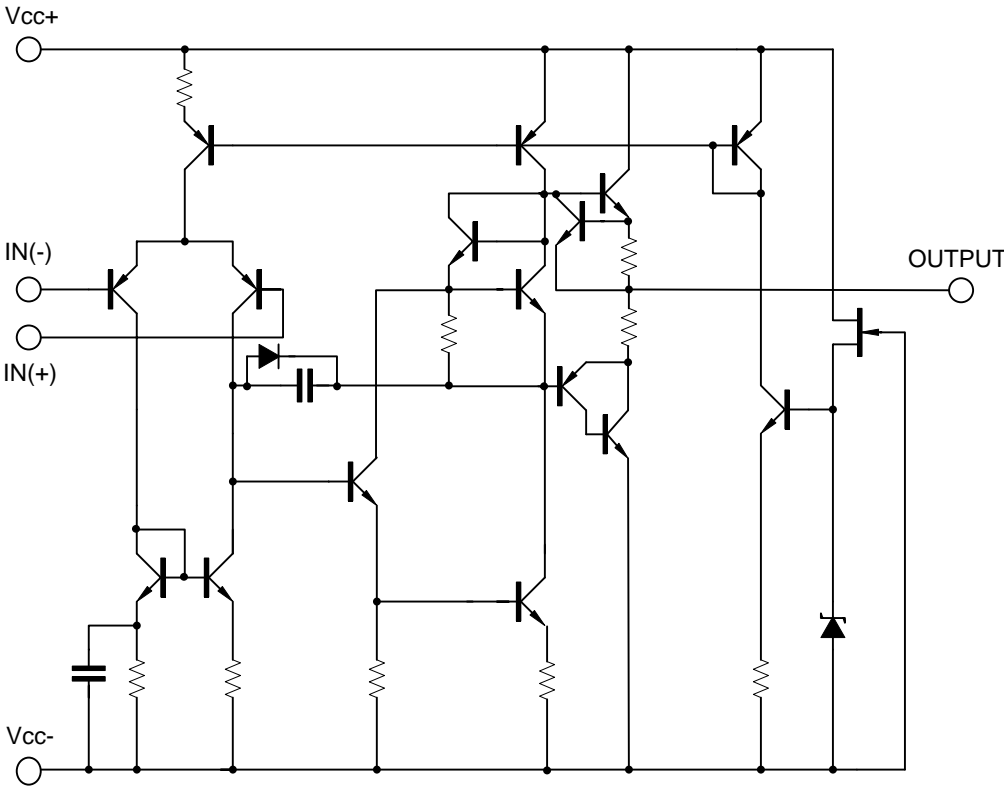

■ ABSOLUTE MAXIMUM RATINGS (Ta=25)

PARAMETER	SYMBOL	RATINGS	UNIT
Supply Voltage	V+/V-	±18	V
Differential Input Voltage	V _{I(DIFF)}	±30	V
Input Voltage	V _{IN}	±15(Note 1)	V
Power Dissipation	DIP-8	700	mW
	SOP-8	300	
Operating Temperature	T _{OPR}	-20 ~ +75	°C
Storage Temperature	T _{STG}	-40 ~ +125	°C

Note: 1. For supply voltage less than ±15V, the absolute maximum input voltage is equal to the supply voltage.

2. Absolute maximum ratings are those values beyond which the device could be permanently damaged.

Absolute maximum ratings are stress ratings only and functional device operation is not implied.

■ ELECTRICAL CHARACTERISTICS (Ta=25°C , V+ / V-=±15V)

PARAMETER	SYMBOL	TEST CONDUCTION	MIN	TYP	MAX	UNIT
Input Offset Voltage	V _{I(OFF)}	R _s ≤ 10kΩ		0.5	6	mV
Input Offset Current	I _{I(OFF)}			5	60	nA
Input Bias Current	I _{I(BIAS)}			50	500	nA
Input Resistance	R _{IN}		0.3	5		MΩ
Large Signal Voltage Gain	G _V	R _L ≥ 2kΩ, V _{OUT} = ±10V	86	100		dB
Maximum Output Voltage 1	V _{OM1}	R _L ≥ 2kΩ	±12.0	±13.5		V
Maximum Output Voltage 2	V _{OM2}	R _L ≥ 150Ω	±10.5	±11.0		V
Input Common Mode Voltage Range	V _{I(CM)}		±13.5	±14.0		V
Common Mode Rejection Ratio	CMR	R _s ≤ 10kΩ	70	90		dB
Supply Voltage Rejection Ratio	SVR	R _s ≤ 10kΩ	76.5	90		dB
Operating Current	I _{CC}			9	12	mA
Slew Rate	SR			3		V/μs
Unity Gain Bandwidth	GB _W			8		MHz

TYPICAL CHARACTERISTICS

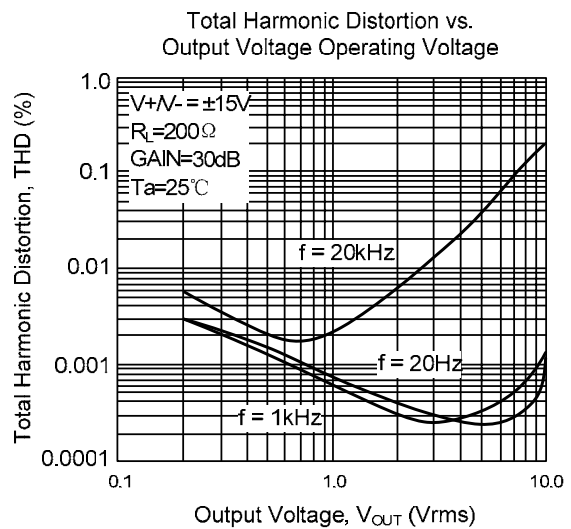
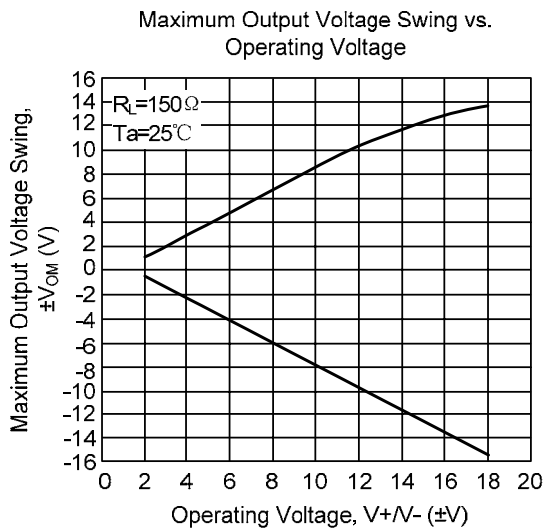
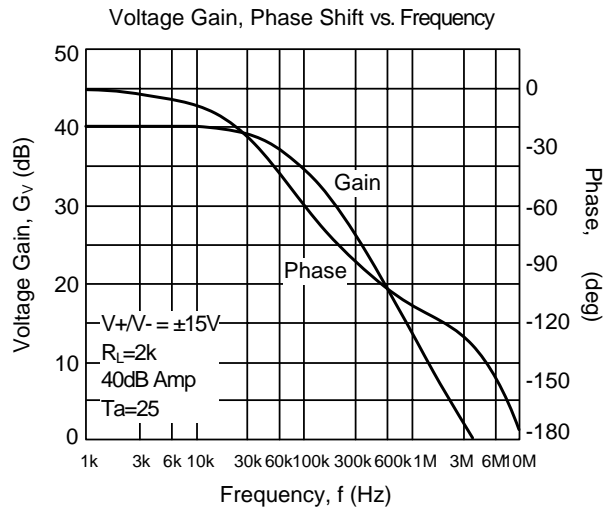
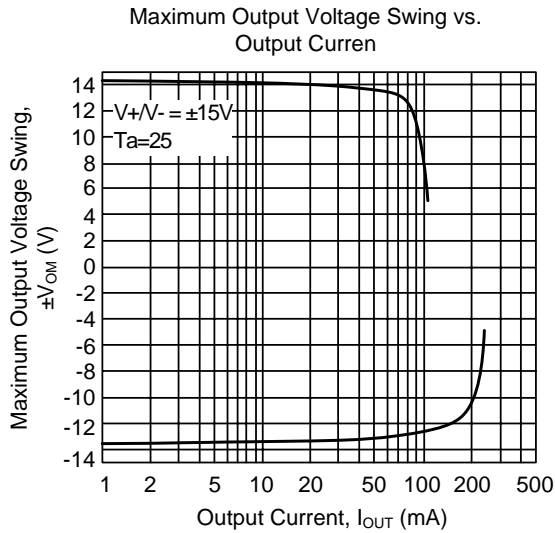
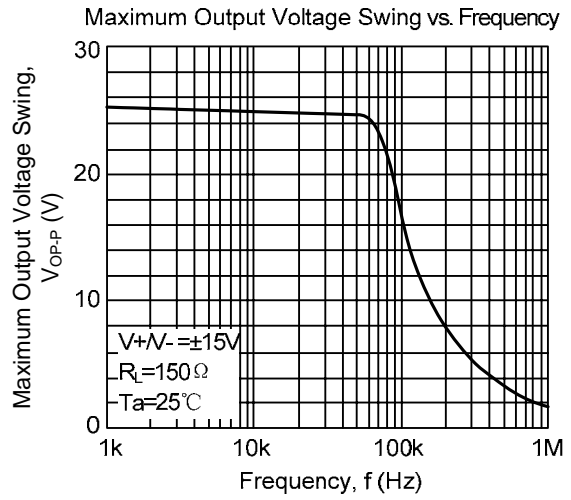
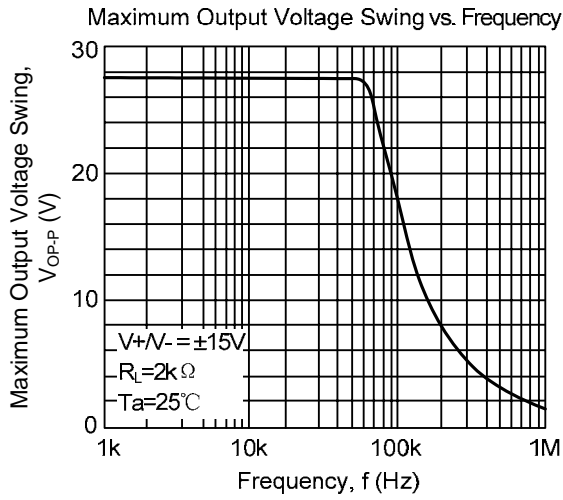

TYPICAL CHARACTERISTICS(Cont.)

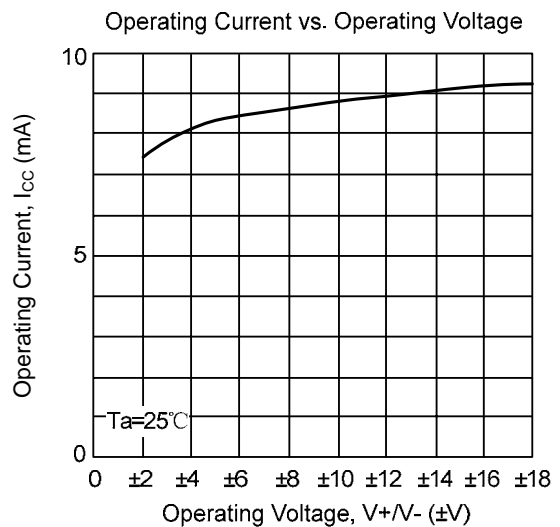
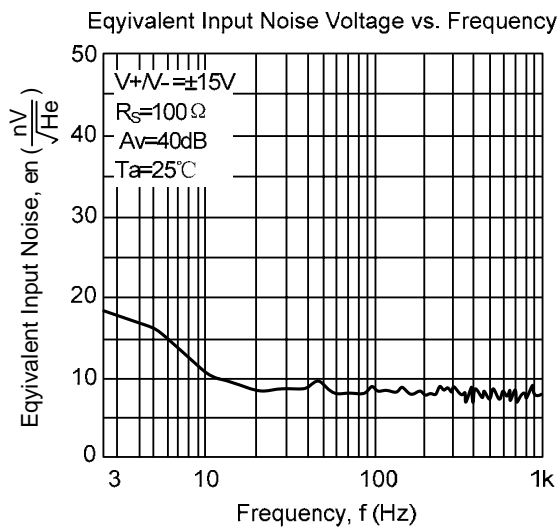
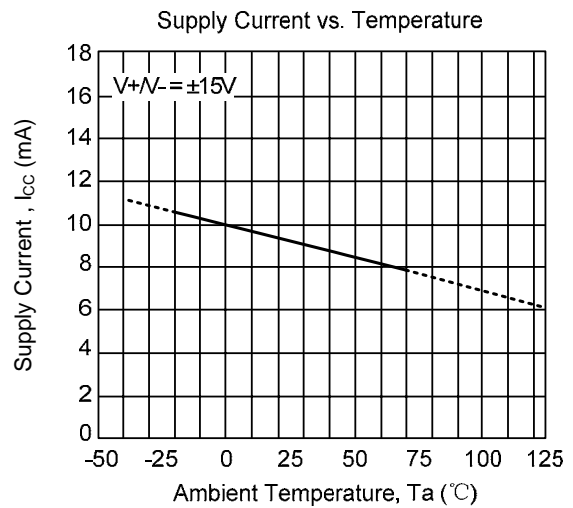
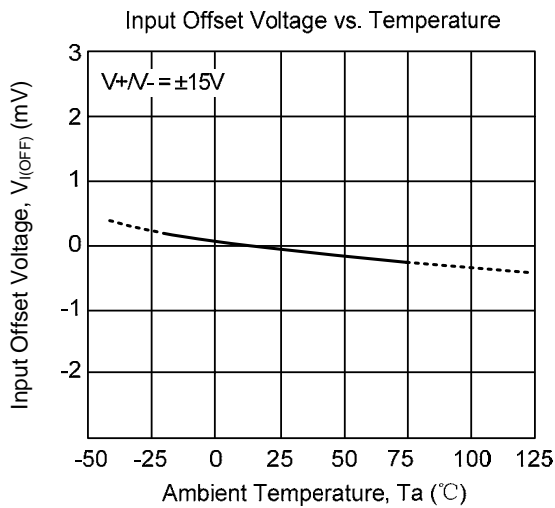
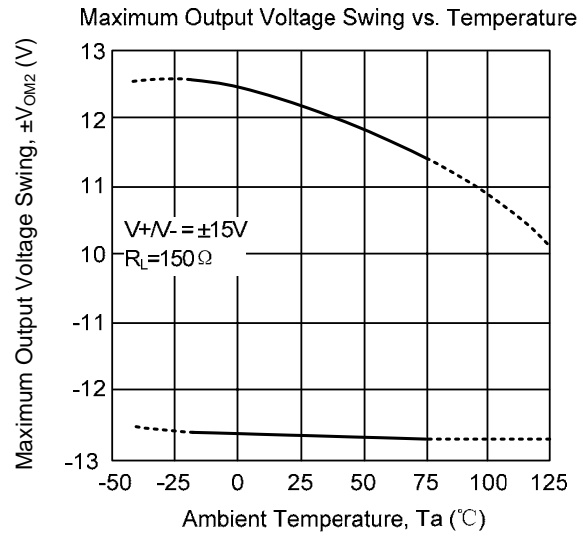
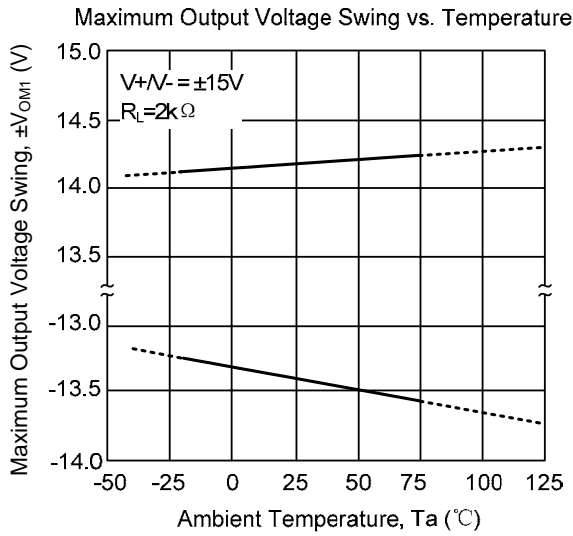

UTC assumes no responsibility for equipment failures that result from using products at values that exceed, even momentarily, rated values (such as maximum ratings, operating condition ranges, or other parameters) listed in products specifications of any and all UTC products described or contained herein. UTC products are not designed for use in life support appliances, devices or systems where malfunction of these products can be reasonably expected to result in personal injury. Reproduction in whole or in part is prohibited without the prior written consent of the copyright owner. The information presented in this document does not form part of any quotation or contract, is believed to be accurate and reliable and may be changed without notice.