



Features

- Lead free device (RoHS compliant*)
- Low profile
- Low power loss, high efficiency
- UL 94V-0 classification

Applications

- High frequency switching power supplies
- Inverters
- Free wheeling
- Polarity protection

CD1408-R1200~R11000 – Surface Mount Rectifier Diode

General Information

The markets of portable communications, computing and video equipment are challenging the semiconductor industry to develop increasingly smaller electronic components. Bourns offers Rectifier Diodes for rectification applications, in compact chip package 1408 size format (compatible with SOD87, SOD123 formats), which offers PCB real estate savings and are considerably smaller than most competitive parts. The Glass Passivated Rectifier Diodes offer a forward current of 1 A with a choice of repetitive peak reverse voltage of 200 V up to 1000 V.

Bourns® Chip Diodes conform to JEDEC standards, are easy to handle on standard pick and place equipment and their flat configuration minimizes roll away.

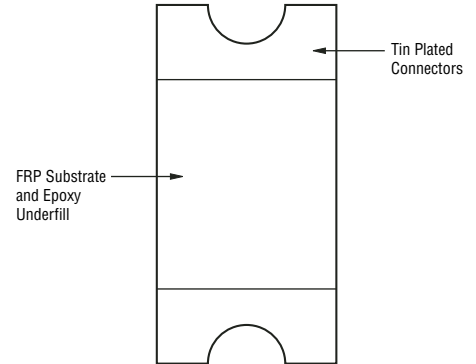

Electrical Characteristics (@ T_A = 25 °C Unless Otherwise Noted)

Parameter	Symbol	CD1408-					Unit
		R1200	R1400	R1600	R1800	R11000	
Maximum Repetitive Peak Reverse Voltage	V _{RRM}	200	400	600	800	1000	V
Maximum RMS Voltage	V _{RMS}	140	280	420	560	700	V
Maximum DC Blocking Voltage	V _{DC}	200	400	600	800	1000	V
Max. Average Forward Rectified Current ¹	I _(AV)	1.0					A
DC Reverse Current @ Rated DC Blocking Voltage (@T _a = 25 °C)	I _R	1.0					μA
DC Reverse Current @ Rated DC Blocking Voltage (@T _a = 125 °C)	I _R	30.0					μA
DC Reverse Current @ Rated DC Blocking Voltage (@T _a = 150 °C)	I _R	50.0					μA
Typical Junction Capacitance ²	C _J	12					pF
Instantaneous Forward Voltage @ I _F = 1 A	V _F	1.0					V
Maximum Reverse Recovery Time ³	T _{rr}	3000					ns
Peak forward surge current 8.3 ms single half sine-wave superimposed on rated load (JEDEC Method)	I _{FSM}	30.0					A

Notes:

1 See Forward Derating Curve.

2 Measured @ 1.0 MHz and applied reverse voltage of 4.0 VDC.

3 Reverse recovery test condition: I_F = 0.5 A, I_R = 1.0 A, I_{rr} = 0.25 A

Thermal Characteristics (@ T_A = 25 °C Unless Otherwise Noted)

Parameter	Symbol	CD1408-R1200~R11000	Unit
Operating Temperature Range	T _J	-65 to +175	°C
Storage Temperature Range	T _{STG}	-65 to +175	°C

*RoHS Directive 2002/95/EC Jan 27 2003 including Annex.

Specifications are subject to change without notice.

Customers should verify actual device performance in their specific applications.

CD1408-R1200~R11000 – Surface Mount Rectifier Diode



Product Dimensions

This is a lead free product, packaged with FRP substrate and is epoxy underfilled. The terminals are pure tin plated and are solderable per MIL-STD-750, Method 2026. The package weighs approximately 0.02 g. The package and dimensions are shown below.

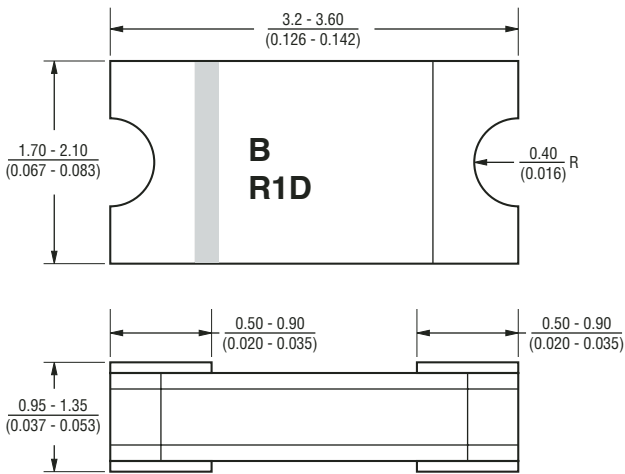

DIMENSIONS: $\frac{\text{MM}}{\text{(INCHES)}}$

Recommended Footprint

The device will mount onto existing JEDEC SOD-87 footprint.

How To Order

CD 1408 - R 1 400

Common Code _____
 CD = Chip Diode
 Package _____
 1408 = ~0.14 x 0.08 ~
 Function _____
 R = Rectifier
 Forward Current $I_{(AV)}$ _____
 1 = 1 A
 Reverse Voltage _____
 200 = 200 V
 400 = 400 V
 600 = 600 V
 800 = 800 V
 1000 = 1000 V

Typical Part Marking

CD1408-R1200 **R1D**
 CD1408-R1400 **R1G**
 CD1408-R1600 **R1J**
 CD1408-R1800 **R1K**
 CD1408-R11000 **R1M**

CD1408-R1200~R11000 – Surface Mount Rectifier Diode

BOURNS®

Packaging Information

The product will be dispensed in Tape and Reel format (see diagram below).

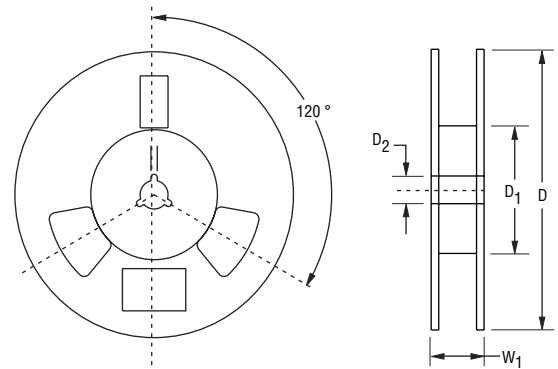
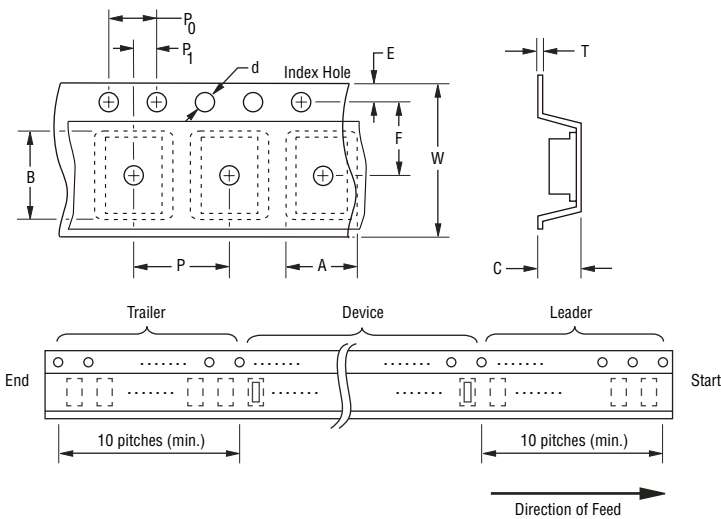

DIMENSIONS: $\frac{\text{MM}}{\text{(INCHES)}}$

Devices are packed in accordance with EIA standard RS-481-A and specifications shown here.

Item	Symbol	1408
Carrier Width	A	$\frac{1.90 \pm 0.10}{(0.075 - 0.004)}$
Carrier Length	B	$\frac{4.30 \pm 0.10}{(0.169 - 0.004)}$
Carrier Depth	C	$\frac{1.80 \pm 0.10}{(0.071 - 0.004)}$
Sprocket Hole	d	$\frac{1.55 \pm 0.05}{(0.061 - 0.002)}$
Reel Outside Diameter	D	$\frac{178}{(7.008)}$
Reel Inner Diameter	D ₁	$\frac{80.0}{(3.150)}$ Min.
Feed Hole Diameter	D ₂	$\frac{13.0 \pm 0.20}{(0.512 - 0.008)}$
Sprocket Hole Position	E	$\frac{1.75 \pm 0.10}{(0.069 - 0.004)}$
Punch Hole Position	F	$\frac{3.50 \pm 0.05}{(0.138 - 0.002)}$
Punch Hole Pitch	P	$\frac{4.00 \pm 0.10}{(0.157 - 0.004)}$
Sprocket Hole Pitch	P ₀	$\frac{4.00 \pm 0.10}{(0.157 - 0.004)}$
Embossment Center	P ₁	$\frac{2.00 \pm 0.05}{(0.079 - 0.002)}$
Overall Tape Thickness	T	$\frac{0.20 \pm 0.10}{(0.008 - 0.004)}$
Tape Width	W	$\frac{8.00 \pm 0.20}{(0.315 - 0.008)}$
Reel Width	W ₁	$\frac{13.5}{(0.531)}$ Max.
Quantity per Reel	—	2,500

Specifications are subject to change without notice. Customers should verify actual device performance in their specific applications.

CD1408-R1200~R11000 – Surface Mount Rectifier Diode



Performance Graphs

Forward Current Derating Curve

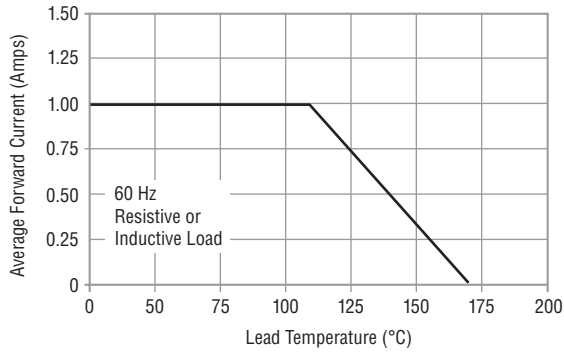

Maximum Non-Repetitive Surge Current

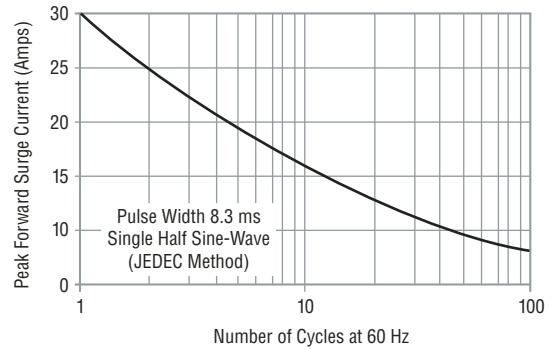

Typical Forward Characteristics

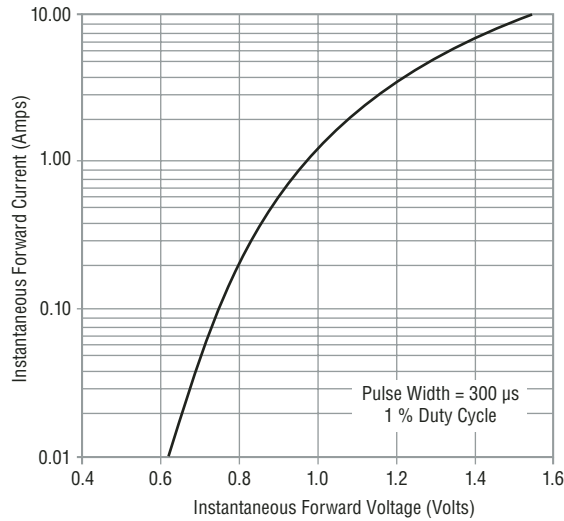

Typical Reverse Characteristics

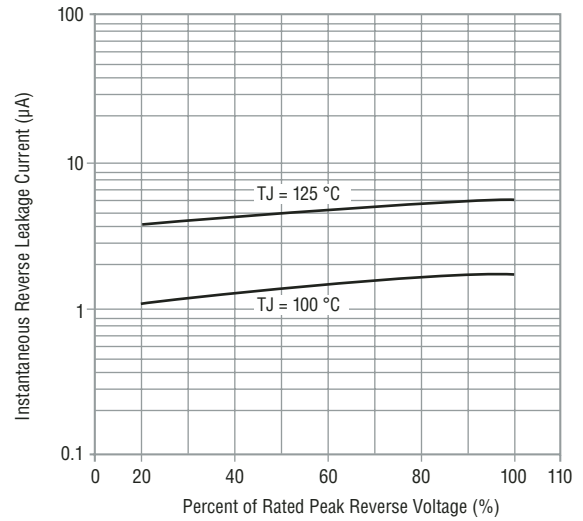

Typical Junction Capacitance

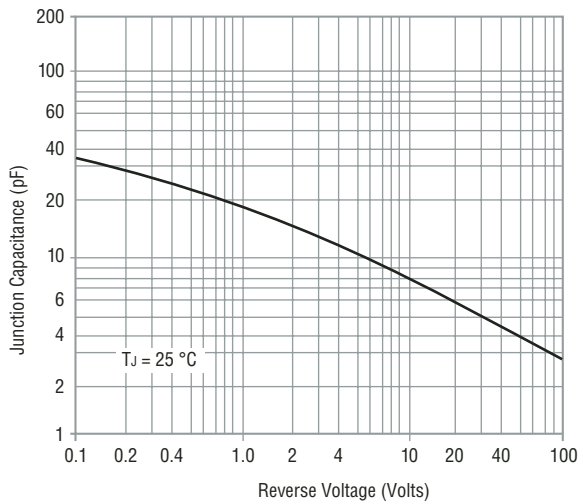

Reliable Electronic Solutions

Asia-Pacific:

Tel: +886-2 2562-4117 • Fax: +886-2 2562-4116

Europe:

Tel: +41-41 768 5555 • Fax: +41-41 768 5510

The Americas:

Tel: +1-951 781-5500 • Fax: +1-951 781-5700

www.bourns.com

REV. 05/06

Specifications are subject to change without notice. Customers should verify actual device performance in their specific applications.