

SWITCHING REGULATOR APPLICATIONS

Features

- High speed switching
- $V_{CEO(sus)} = 400V$
- Suitable for Switching Regulator and Motor Control

Ordering Information

Type NO.	Marking	Package Code
STD13005IS	STD13005	I-PAK

PIN Connection

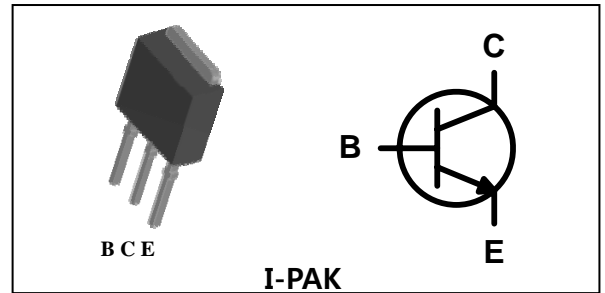

Marking Diagram

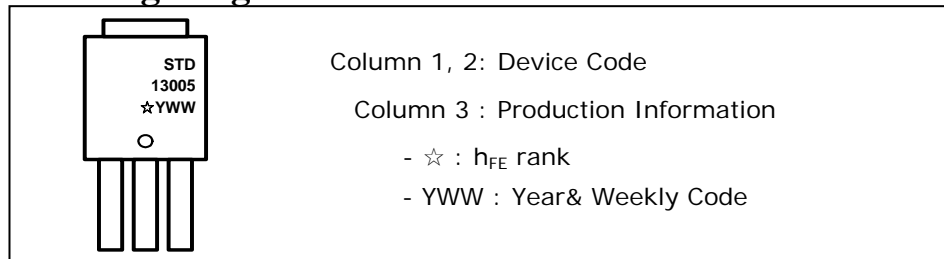

Absolute maximum ratings

 $(T_c = 25^\circ C)$

Characteristic	Symbol	Ratings	Unit
Collector-Base voltage	V_{CBO}	700	V
Collector-Emitter voltage	V_{CEO}	400	V
Emitter-base voltage	V_{EBO}	9	V
Collector current (DC)	I_C	4	A
Collector current (Pulse)	I_{CM}	8	A
Base current (DC)	I_B	2	A
Base current (Pulse)	I_{BM}	4	A
Total Power dissipation ($T_c = 25^\circ C$)	P_D	30	W
Junction temperature	T_j	150	$^\circ C$
Storage temperature	T_{stg}	-55 ~ 150	$^\circ C$

Characteristic	Symbol	Typ.	Max	Unit
Thermal resistance	Junction-case	-	4.16	$^\circ C/W$
	Junction-ambient	-	62.5	

Electrical Characteristics

(Tc=25°C)

Characteristic	Symbol	Test Condition	Min.	Typ.	Max.	Unit
Collector-Emitter sustaining voltage	$V_{CE(sus)}$	$I_C=10mA, I_B=0$	400	-	-	V
Collector cut-off current	I_{CEV}	$V_{CEV}=\text{Rated Value}$ $V_{BE(off)}=1.5V$	-	-	1	mA
Emitter cut-off current	I_{EBO}	$V_{EB}=9V, I_C=0$	-	-	1	mA
DC Current gain	h_{FE}^*	$I_C=1A, V_{CE}=5V^{**}$	15	-	40	
		$I_C=2A, V_{CE}=5V$	8	-	40	
Collector-Emitter saturation voltage	$V_{CE(sat)}^*$	$I_C=1A, I_B=0.2A$	-	-	0.5	V
		$I_C=2A, I_B=0.5A$	-	-	0.6	
		$I_C=4A, I_B=1A$	-	-	1	
Base-Emitter saturation voltage	$V_{BE(sat)}^*$	$I_C=1A, I_B=0.2A$	-	-	1.2	V
		$I_C=2A, I_B=0.5A$	-	-	1.6	
Transition frequency	f_T	$V_{CB}=10V, I_C=0.5A, f=1MHz$	-	4	-	MHz
Output capacitance	C_{ob}	$V_{CB}=10V, I_E=0, f=0.1MHz$	-	65	-	pF
Turn on Time	t_{ON}	$V_{CC}=125V, I_C=2A, R_L=62.5\Omega$ $I_{B1}=-I_{B2}=0.4A$	-	0.8	-	μs
Storage Time	t_{STG}		-	4	-	
Fall Time	t_F		-	0.9	-	

* Pulse test: $PW \leq 300 \mu s$, Duty cycle $\leq 2\%$ Pulse

** h_{FE} rank / A : 15~30, B : 25~40

Electrical Characteristic Curves

Fig. 1 $P_D - T_C$

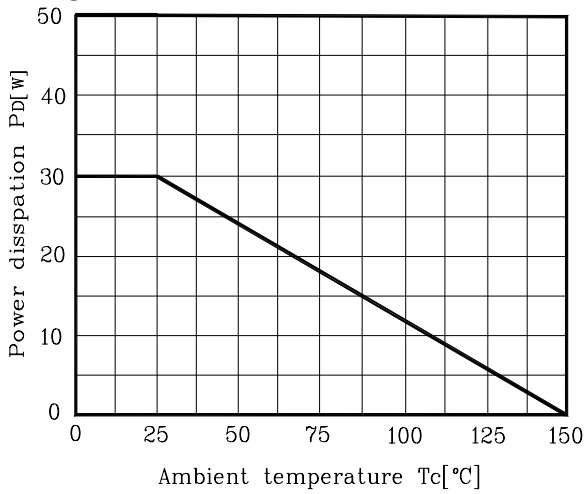

Fig. 2 $V_{BE(sat)}, V_{CE(sat)} - I_C$

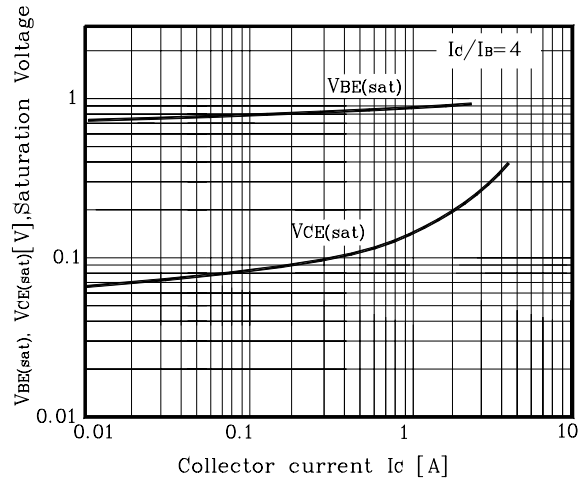

Fig. 3 $h_{FE} - I_C$

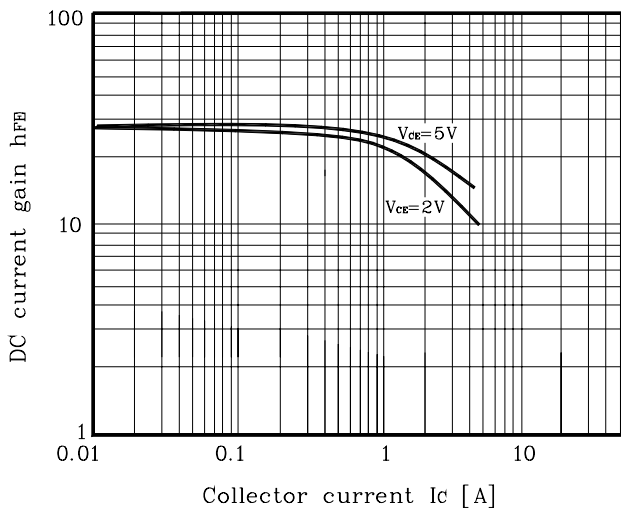

Fig. 4 Turn off time

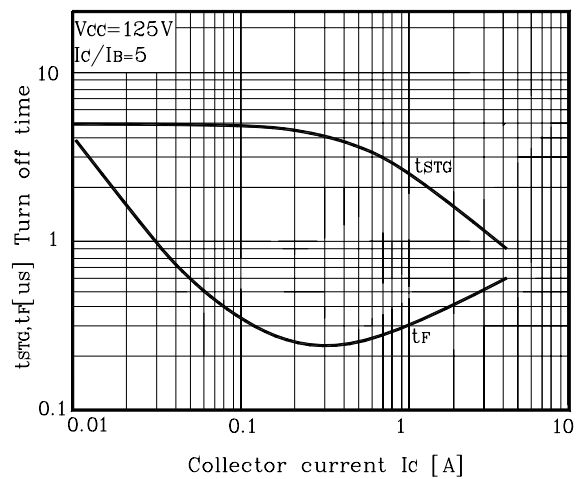

Fig. 5 Turn on time

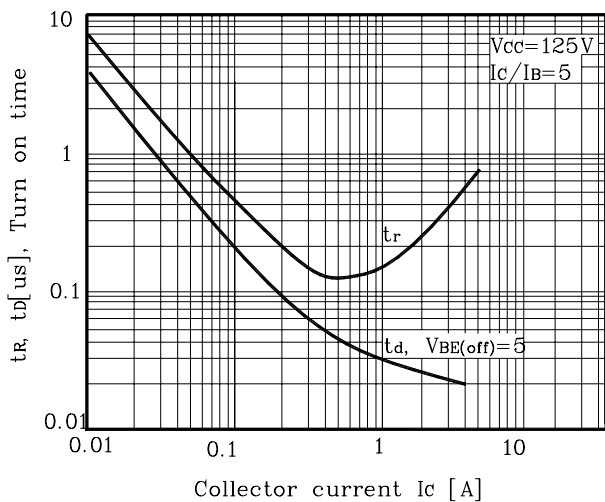
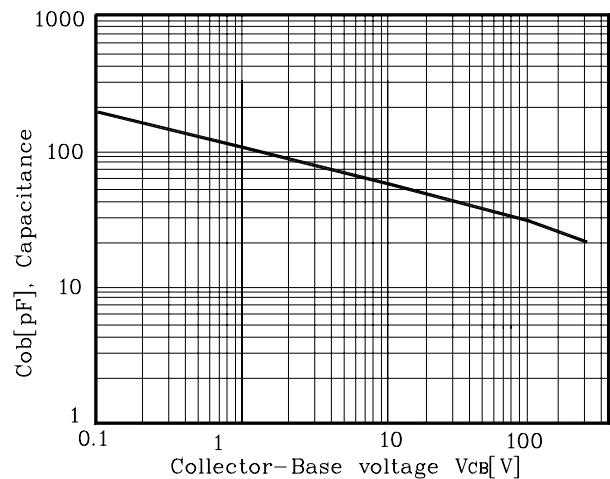
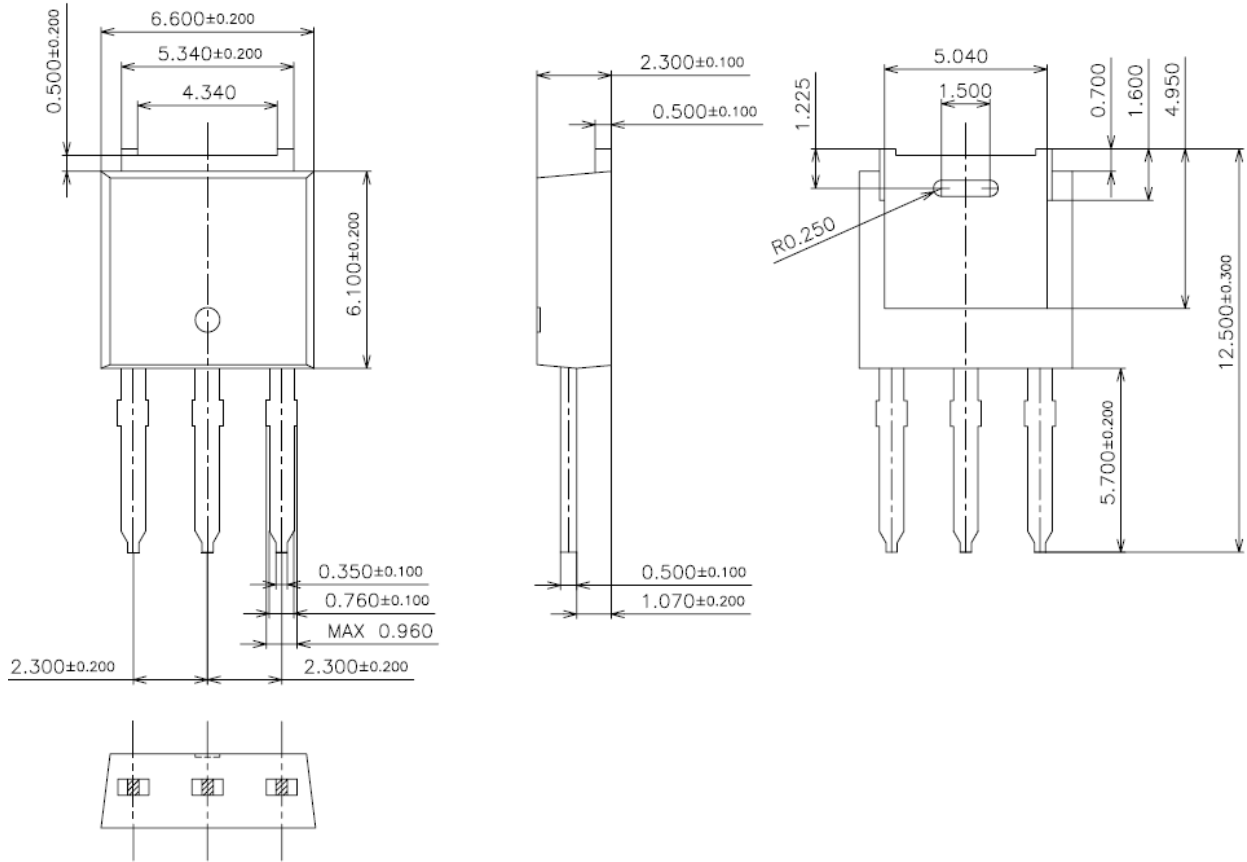

Fig. 6 Capacitance



Outline Dimensions



The AUK Corp. products are intended for the use as components in general electronic equipment (Office and communication equipment, measuring equipment, home appliance, etc.).

Please make sure that you consult with us before you use these AUK Corp. products in equipments which require high quality and / or reliability, and in equipments which could have major impact to the welfare of human life(atomic energy control, airplane, spaceship, transportation, combustion control, all types of safety device, etc.). AUK Corp. cannot accept liability to any damage which may occur in case these AUK Corp. products were used in the mentioned equipments without prior consultation with AUK Corp..

Specifications mentioned in this publication are subject to change without notice.