

## General Description

The MIC5385 is an advanced general purpose triple linear regulator offering high power supply rejection (PSRR) in an ultra-small 2mm x 2mm 8 pin Thin MLF<sup>®</sup> package. The MIC5385 is capable of sourcing 150mA for each output and offers high PSRR making it an ideal solution for any portable electronic application.

Ideal for battery powered applications, the MIC5385 offers 2% initial accuracy, low dropout voltage (180mV @ 150mA), and low ground current (typically 32 $\mu$ A per output). The MIC5385 can also be put into a zero-off-mode current state, drawing virtually no current when disabled.

The MIC5385 is available in a lead-free (RoHS compliant) 2mm x 2mm 8 pin Thin MLF<sup>®</sup> occupying only 4mm<sup>2</sup> of PCB area, a 33% reduction in board area compared to a 3mm x 2mm Thin MLF<sup>®</sup> package.

The MIC5385 has an operating junction temperature range of -40°C to 125°C.

Datasheets and support documentation can be found on Micrel's web site at: [www.micrel.com](http://www.micrel.com).

## Features

- Input voltage range: 2.5V to 5.5V
- 150mA guaranteed output current for each output
- Stable with ceramic output capacitors
- Low dropout voltage – 180mV @ 150mA
- Excellent Load/Line Transient Response
- Low quiescent current – 32 $\mu$ A per LDO
- High PSRR – 70dB
- High output accuracy
  - $\pm$ 2% initial accuracy
- Thermal shutdown and current limit protection
- Available in tiny 2mm x 2mm Thin MLF<sup>®</sup>

## Applications

- Mobile phones
- Digital cameras
- GPS, PDAs, PMP, handhelds
- Portable electronics

## Typical Application

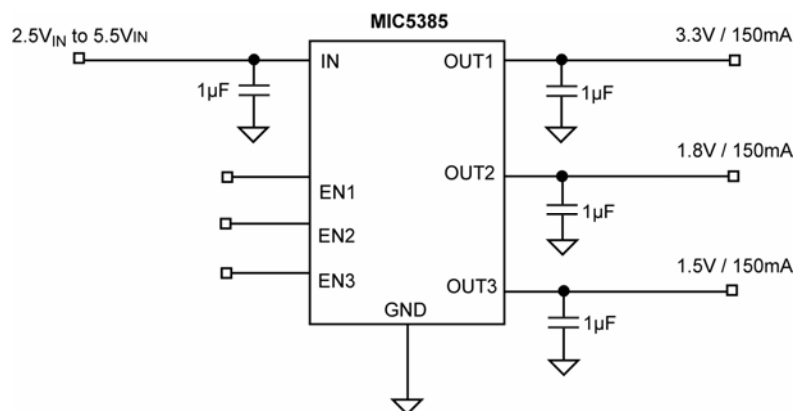

## Ordering Information

Part Number	Marking Code	V <sub>OUT1</sub>	V <sub>OUT2</sub>	V <sub>OUT3</sub>	Temperature Range	Package
MIC5385-SGFYMT	ZN1	3.3V	1.8V	1.5V	-40°C to +125°C	8-Pin 2mm x 2mm Thin MLF <sup>®</sup>

### Notes:

- Other voltages available. Contact Micrel for details.
- MLF<sup>®</sup> ▲ = Pin 1 identifier.
- MLF<sup>®</sup> is a GREEN RoHS-compliant package. Lead finish is NiPdAu. Mold compound is Halogen Free.

## Pin Configuration

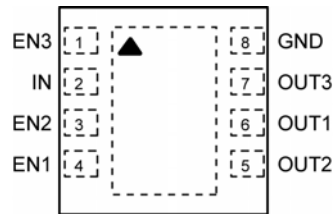

8-Pin 2mm x 2mm Thin MLF<sup>®</sup> (MT)

## Pin Description

Pin Number	Pin Names	Pin Function
1	EN3	Enable Input 3: Enables LDO3, Active High. High = ON; Low = OFF. Do not leave floating.
2	IN	Input supply for LDO1, 2 and 3.
3	EN2	Enable Input 2: Enables LDO2, Active High. High = ON; Low = OFF. Do not leave floating.
4	EN1	Enable Input 1: Enables LDO1, Active High. High = ON; Low = OFF. Do not leave floating.
5	OUT2	Output Voltage for LDO2.
6	OUT1	Output Voltage for LDO1.
7	OUT3	Output Voltage for LDO3.
8	GND	Ground for LDO1, 2 and 3.
EP	HS Pad	Exposed Heatsink Pad. (connect to Ground plane for best thermal).

**Absolute Maximum Ratings<sup>(1)</sup>**

Supply Voltage ( $V_{IN}$ )	-0.3V to 6V
Enable Voltage ( $V_{EN}$ )	-0.3V to $V_{IN}$
Power Dissipation ( $P_D$ )	Internally Limited <sup>(3)</sup>
Lead Temperature (soldering, 3 $\mu$ sec)	260°C
Junction Temperature ( $T_J$ )	-40°C to +150°C
Storage Temperature ( $T_S$ )	-65°C to +150°C
ESD Rating <sup>(4)</sup>	2kV

**Operating Ratings<sup>(2)</sup>**

Supply Voltage ( $V_{IN}$ )	2.5V to 5.5V
Enable Voltage ( $V_{EN}$ )	0V to $V_{IN}$
Junction Temperature ( $T_J$ )	-40°C to +125°C
Junction Thermal Resistance 2mm x 2mm Thin MLF <sup>®</sup> ( $\theta_{JA}$ )	90°C/W

**Electrical Characteristics<sup>(5)</sup>**

$V_{IN} = V_{EN1} = V_{EN2} = V_{EN3} = V_{OUT} + 1V$ ; highest of the three outputs;  $C_{IN} = C_{OUT1} = C_{OUT2} = C_{OUT3} = 1\mu F$ ;  $I_{OUT1} = I_{OUT2} = I_{OUT3} = 100\mu A$ ;  $T_J = 25^\circ C$ , **bold** values indicate -40°C to +125°C, unless noted.

Parameter	Condition	Min	Typ	Max	Units
Output Voltage Accuracy	Variation from nominal $V_{OUT}$	-2.0		+2.0	%
	Variation from nominal $V_{OUT}$ ; -40°C to +125°C	<b>-3.0</b>		<b>+3.0</b>	%
Line Regulation	$V_{IN} = V_{OUT} + 1V$ to 5.5V; $I_{OUT} = 100\mu A$		0.02	<b>0.3</b>	%
Load Regulation <sup>(6)</sup>	$I_{OUT} = 100\mu A$ to 150mA		0.65		%
Dropout Voltage <sup>(7)</sup>	$I_{OUT} = 50mA$ ; $V_{OUT} \geq 2.8V$		55	<b>110</b>	mV
	$I_{OUT} = 150mA$ ; $V_{OUT} \geq 2.8V$		155	<b>310</b>	mV
	$I_{OUT} = 50mA$ ; $V_{OUT} < 2.8V$		60	<b>135</b>	mV
	$I_{OUT} = 150mA$ ; $V_{OUT} < 2.8V$		180	<b>380</b>	mV
Ground Pin Current <sup>(8)</sup>	$I_{OUT} = 0mA$ ; $V_{OUT} > 1.3V$ , Single output enabled		32		$\mu A$
	$I_{OUT} = 0mA$ ; $V_{OUT} > 1.3V$ , $V_{EN1}=V_{EN2}=V_{EN3} \geq 1.2V$		96	<b>120</b>	$\mu A$
Ground Pin Current in Shutdown	$V_{EN1}=V_{EN2}=V_{EN3} \leq 0.2V$		0.05	1	$\mu A$
Ripple Rejection	$f = \text{up to } 1\text{kHz}$ ; $C_{OUT} = 1\mu F$ ; $V_{OUT} < 2.5V$		70		dB
	$f = 1\text{kHz} - 10\text{kHz}$ ; $C_{OUT} = 1\mu F$ ; $V_{OUT} < 2.5V$		50		dB
Current Limit	$V_{OUT} = 0V$	200	325	550	mA
Output Voltage Noise	$C_{OUT} = 1\mu F$ , 10Hz to 100kHz		200		$\mu V_{RMS}$
<b>Enable Input</b>					
Enable Input Voltage EN1, EN2, EN3	Logic Low			<b>0.2</b>	V
	Logic High	<b>1.2</b>			V
Enable Input Current EN1, EN2, EN3	$V_{IL} \leq 0.2V$		0.01	<b>1</b>	$\mu A$
	$V_{IH} \geq 1.2V$		0.01	<b>1</b>	$\mu A$
Turn-on Time	$C_{OUT} = 1\mu F$ ; $I_{OUT} = 150mA$		50	<b>125</b>	$\mu s$

**Notes:**

- Exceeding the absolute maximum rating may damage the device.
- The device is not guaranteed to function outside its operating rating.
- The maximum allowable power dissipation of any  $T_A$  (ambient temperature) is  $P_{D(max)} = (T_{J(max)} - T_A) / \theta_{JA}$ . Exceeding the maximum allowable power dissipation will result in excessive die temperature, and the regulator will go into thermal shutdown.
- Devices are ESD sensitive. Handling precautions recommended. Human body model, 1.5k $\Omega$  in series with 100pF.
- Specification for packaged product only.
- Regulation is measured at constant junction temperature using low duty cycle pulse testing, changes in output voltage due to heating effects are covered by the thermal regulation specification.
- Dropout voltage is defined as the input-to-output differential at which the output voltage drops 2% below its nominal value measured at 1V differential.  
For outputs below 2.5V, dropout voltage is the input-to-output differential with the minimum input voltage 2.5V.
- Ground pin current is the regulator quiescent current. The total current drawn from the supply is the sum of the load current plus the ground pin current.

# Typical Characteristics

**Power Supply Rejection Ratio**

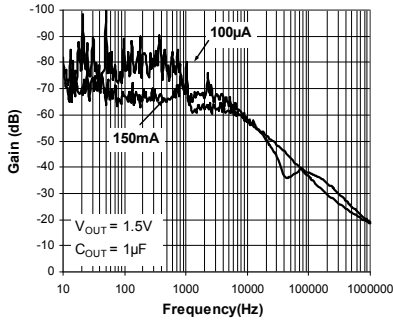

**Dropout Voltage vs Output Current**

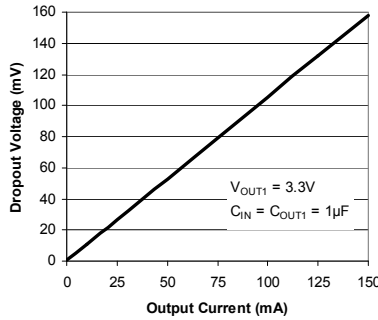

**Dropout Voltage vs Temperature**

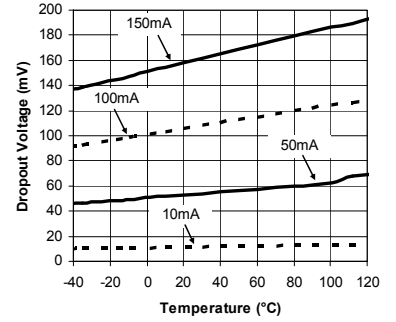

**Ground Current vs Supply Voltage (single output)**

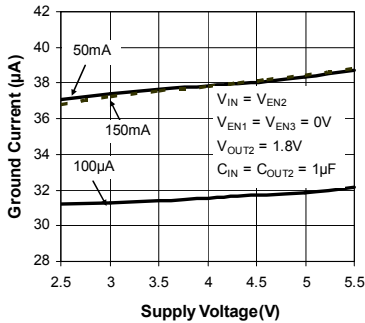

**Ground Current vs Supply Voltage (single output)**

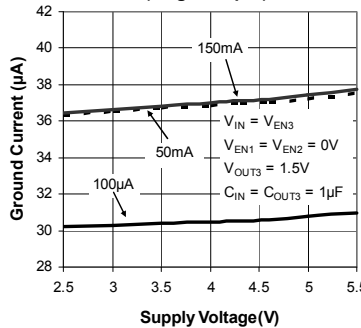

**Ground Current vs Supply Voltage (All outputs)**

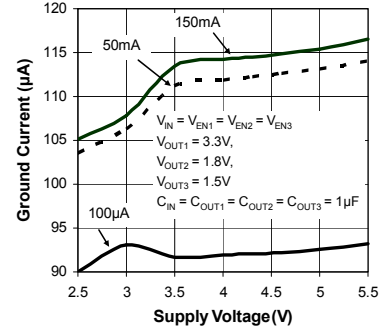

**Ground Current vs Temperature (single output)**

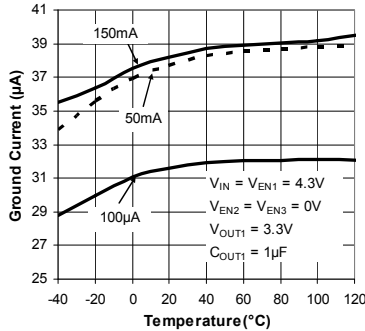

**Output Voltage vs. Supply Voltage ( $V_{OUT} = 3.3V$ )**

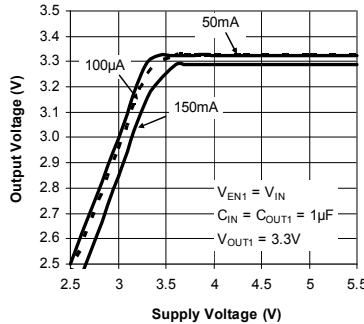

**Output Voltage vs Supply Voltage ( $V_{OUT} = 1.8V$ )**

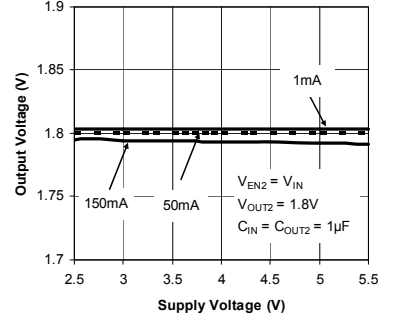

**Output Voltage vs Supply Voltage ( $V_{OUT} = 1.5V$ )**

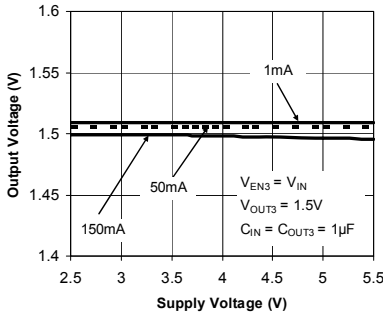

**Output Voltage vs Temperature ( $V_{OUT} = 3.3V$ )**

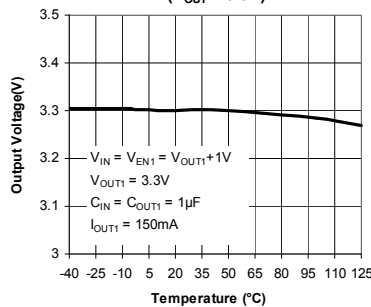

**Output Voltage vs Temperature ( $V_{OUT} = 1.8V$ )**

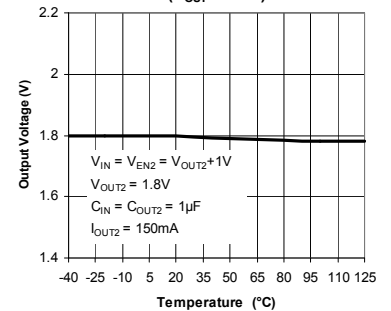

## Typical Characteristics (Continued)

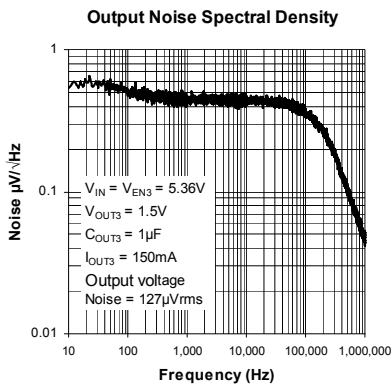
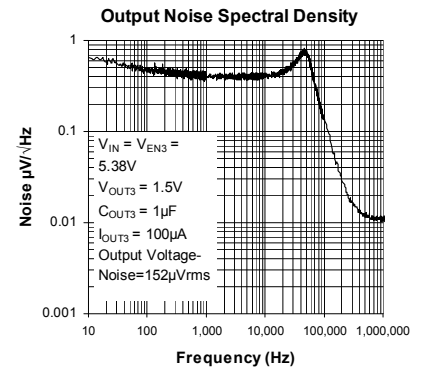
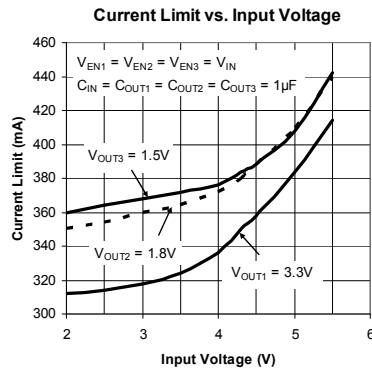
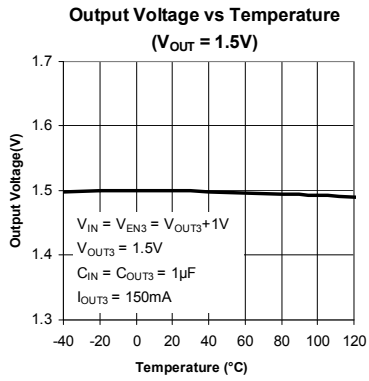

# Functional Characteristics

Start Up

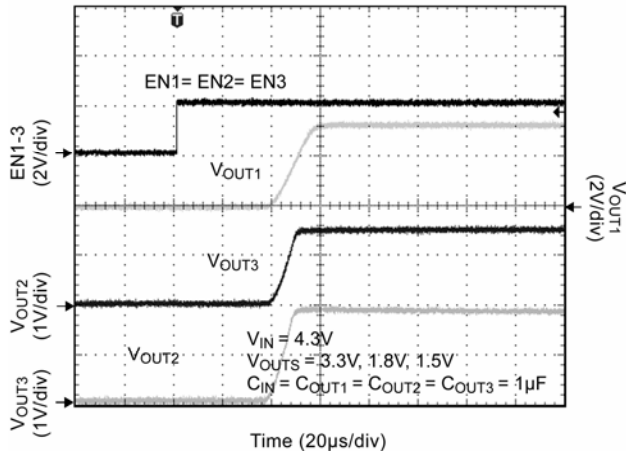

Line Transient

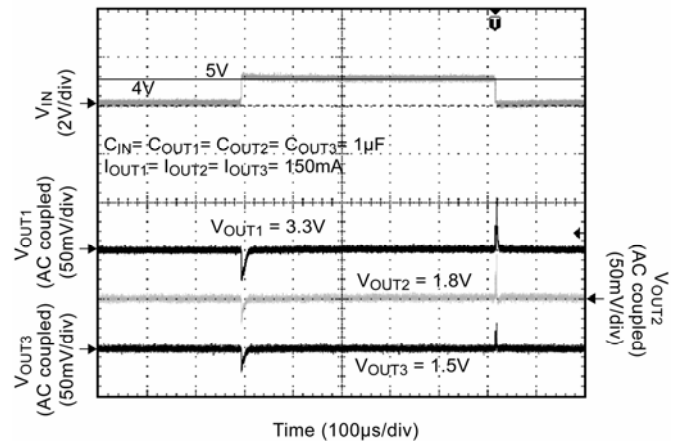

Line Transient

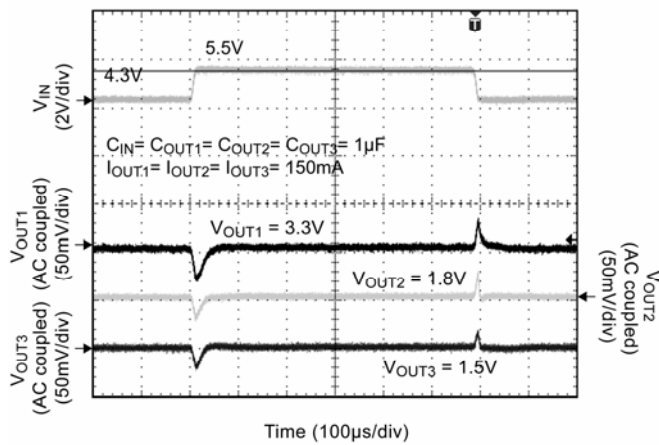

Load Transient  $V_{OUT1}$   
( $I_{OUT1} = 0mA$  to 150mA)

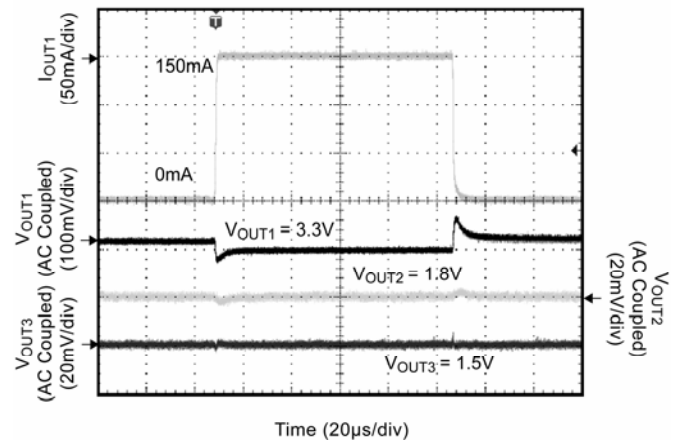

Load Transient  $V_{OUT1}$   
( $I_{OUT1} = 0mA$  to 150mA)

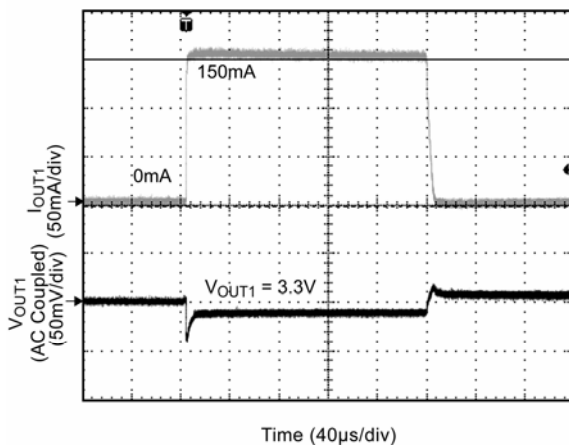

Load Transient  $V_{OUT2}$   
( $I_{OUT2} = 0mA$  to 150mA)

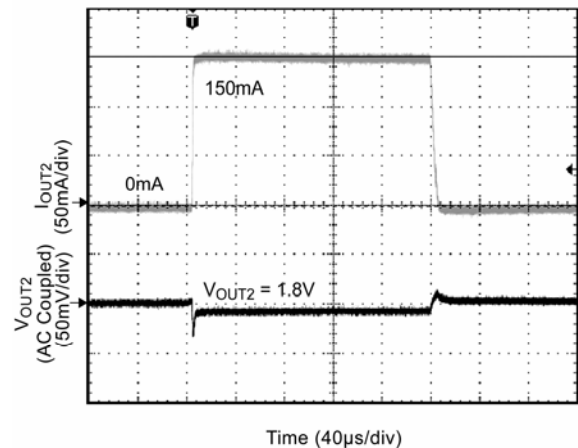

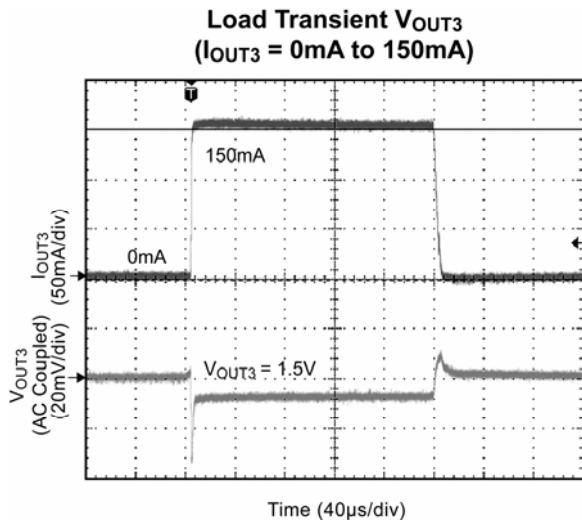

### Block Diagram

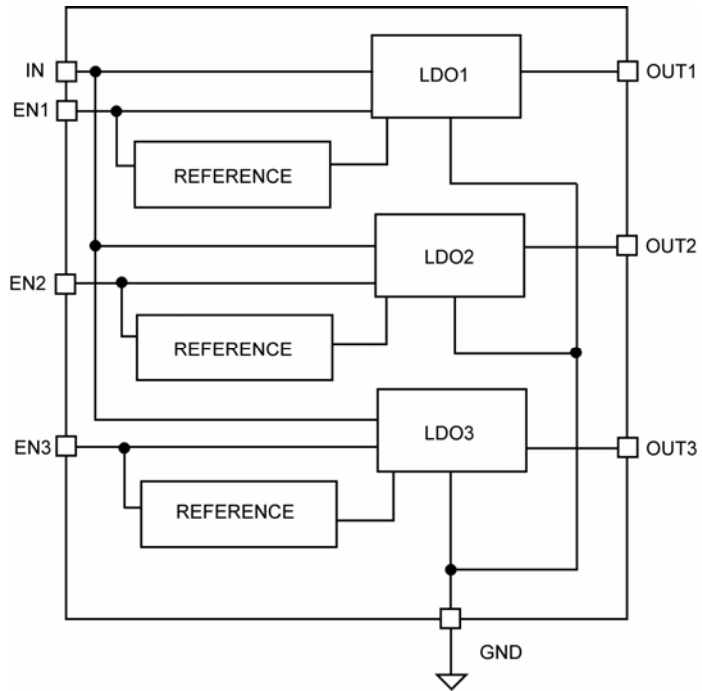



## Application Information

MIC5385 is a triple output Low noise 150mA LDO. The MIC5385 regulator is fully protected from damage due to fault conditions, offering linear current limiting and thermal shutdown.

### Input Capacitor

The MIC5385 is a high-performance, high bandwidth device. An input capacitor of 1 $\mu$ F is required from the input-to-ground to provide stability. Low-ESR ceramic capacitors provide optimal performance at a minimum of space. Additional high-frequency capacitors, such as small-valued NPO dielectric-type capacitors, help filter out high-frequency noise and are good practice in any RF-based circuit. X5R or X7R dielectrics are recommended for the input capacitor. Y5V dielectrics lose most of their capacitance over temperature and are therefore, not recommended.

### Output Capacitor

The MIC5385 requires an output capacitor of 1 $\mu$ F or greater for each output to maintain stability. The design is optimized for use with low-ESR ceramic chip capacitors. High ESR capacitors are not recommended because they may cause high frequency oscillation. The output capacitor can be increased, but performance has been optimized for a 1 $\mu$ F ceramic output capacitor and does not improve significantly with larger capacitance.

X7R/X5R dielectric-type ceramic capacitors are recommended because of their temperature performance. X7R-type capacitors change capacitance by 15% over their operating temperature range and are the most stable type of ceramic capacitors. Z5U and Y5V dielectric capacitors change value by as much as 50% and 60%, respectively, over their operating temperature ranges. To use a ceramic chip capacitor with Y5V dielectric, the value must be much higher than an X7R ceramic capacitor to ensure the same minimum capacitance over the equivalent operating temperature range.

### No-Load Stability

Unlike many other voltage regulators, the MIC5385 will remain stable and in regulation with no load. This is especially important in CMOS RAM keep-alive applications.

### Enable/Shutdown

The MIC5385 comes with an active-high enable pin that allows the regulator to be disabled. Forcing the enable pin low disables the regulator and sends it into a “zero” off-mode-current state. In this state, current consumed by the regulator goes nearly to zero. Forcing the enable pin high enables the output voltage. The active-high enable pin uses CMOS technology and the enable pin cannot be left floating; a floating enable pin may cause an indeterminate state on the output.

### Thermal Considerations

The MIC5385 is designed to provide three outputs up to 150mA each of continuous current in a very small package. Maximum ambient operating temperature can be calculated based on the output current and the voltage drop across the part. For example if the input voltage is 3.6V and the output voltages are 3.3V, 1.8V, and 1.5V each with an output current = 150mA. The actual power dissipation of the regulator circuit can be determined using the equation:

$$P_D = (V_{IN} - V_{OUT1}) I_{OUT1} + (V_{IN} - V_{OUT2}) I_{OUT2} + (V_{IN} - V_{OUT3}) I_{OUT} + V_{IN} I_{GND}$$

As the MIC5385 is a CMOS device, the ground current is typically <100 $\mu$ A over the load range, the power dissipation contributed by the ground current is < 1% and may be ignored for this calculation.

$$P_D = (3.6V - 3.3V)150mA + (3.6V - 1.8V)150mA + (3.6V - 1.5V)150mA$$

$$P_D = 0.63W$$

To determine the maximum ambient operating temperature of the package, use the junction-to-ambient thermal resistance of the device and the following basic equation:

$$P_{D(max)} = \left( \frac{T_{J(max)} - T_A}{\theta_{JA}} \right)$$

$T_{J(max)} = 125^\circ\text{C}$ , the maximum junction temperature of the die, and  $\theta_{JA}$  thermal resistance =  $90^\circ\text{C/W}$  for the Thin MLF<sup>®</sup> package.

Substituting  $P_D$  for  $P_{D(max)}$  and solving for the ambient operating temperature will give the maximum operating conditions for the regulator circuit.

The maximum power dissipation must not be exceeded for proper operation.

For example, when operating the MIC5385-SGFYMT at an input voltage of 3.6V and 450mA load with a minimum footprint layout, the maximum ambient operating temperature  $T_A$  can be determined as follows:

$$0.63W = (125^{\circ}\text{C} - T_A)/(90^{\circ}\text{C/W})$$

$$T_A = 68.3^{\circ}\text{C/W}$$

Therefore, the maximum ambient operating temperature of  $68.3^{\circ}\text{C}$  is allowed in a 2mm x 2mm thin MLF<sup>®</sup> package. For a full discussion of heat sinking and thermal effects on voltage regulators, refer to the "Regulator Thermals" section of *Micrel's Designing with Low-Dropout Voltage Regulators* handbook. This information can be found on Micrel's website at:

[http://www.micrel.com/\\_PDF/other/LDOBk\\_ds.pdf](http://www.micrel.com/_PDF/other/LDOBk_ds.pdf)

## Typical Application

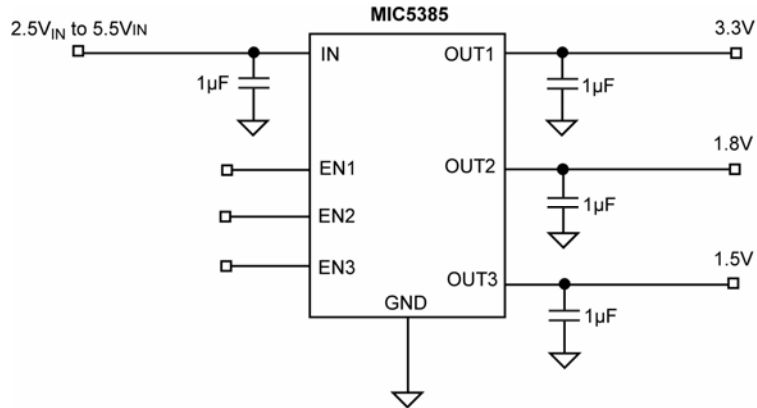

## Bill of Materials

Item	Part Number	Manufacturer	Description	Qty.
C1,C2,C3,C4	C1005X5R1A105K	TDK <sup>(1)</sup>	Capacitor, 1µF Ceramic, 10V, X5R, Size 0402	4
U1	MIC5385-SGFYMT	Micrel, Inc. <sup>(2)</sup>	High Performance Triple 150mA LDO	1

**Notes:**

1. TDK: [www.tdk.com](http://www.tdk.com)
2. Micrel, Inc.: [www.micrel.com](http://www.micrel.com)

# PCB Layout Recommendations (2mm x 2mm Thin MLF<sup>®</sup>)

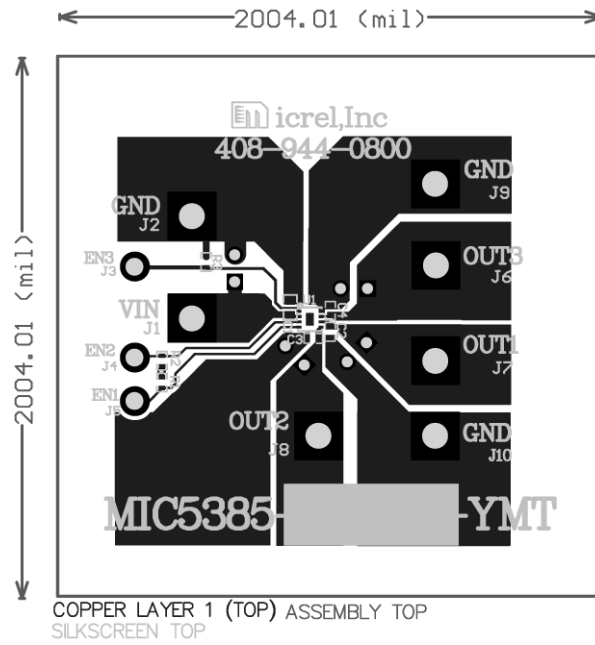

**Top Layer**

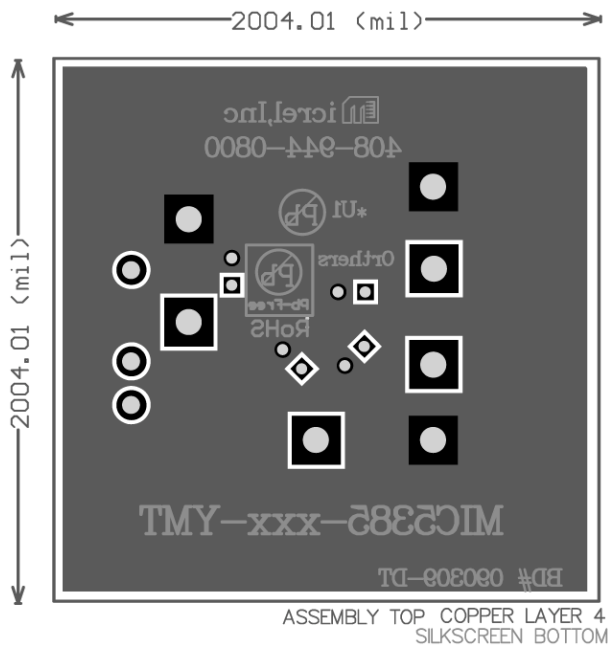

**Bottom Layer**

### Package Information

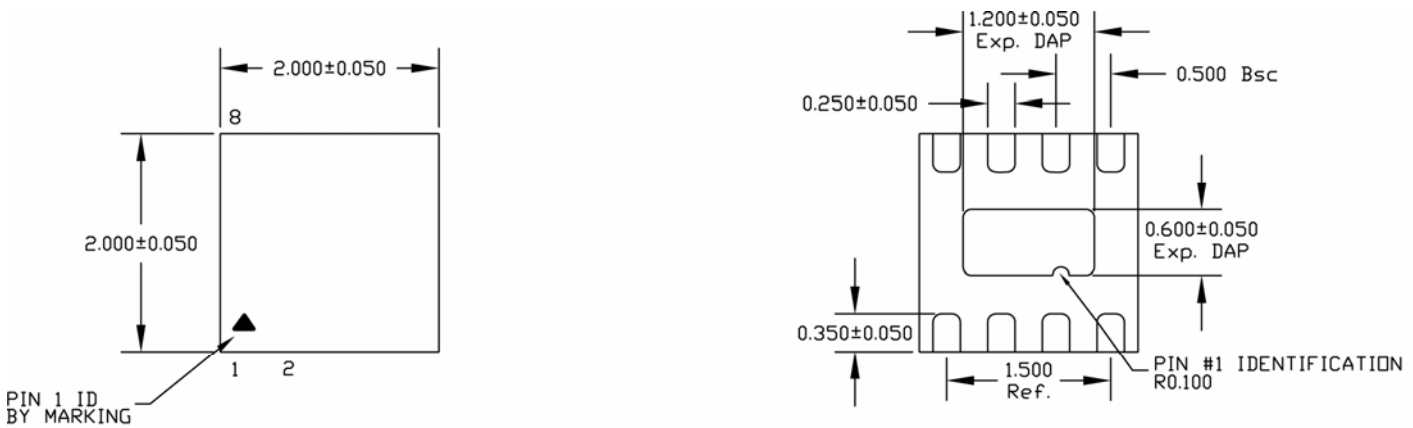

TOP VIEW

BOTTOM VIEW

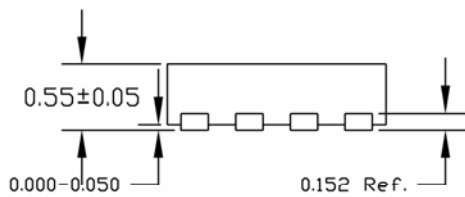

SIDE VIEW

NOTE:

1. ALL DIMENSIONS ARE IN MILLIMETERS.
2. MAX. PACKAGE WARPAGE IS 0.08 mm.
3. MAXIMUM ALLOWABLE BURRS IS 0.076 mm IN ALL DIRECTIONS.
4. PIN #1 ID WILL BE LASER MARKED.

**8-Pin 2mm x 2mm Thin MLF® (MT)**

**MICREL, INC. 2180 FORTUNE DRIVE SAN JOSE, CA 95131 USA**  
 TEL +1 (408) 944-0800 FAX +1 (408) 474-1000 WEB <http://www.micrel.com>

The information furnished by Micrel in this data sheet is believed to be accurate and reliable. However, no responsibility is assumed by Micrel for its use. Micrel reserves the right to change circuitry and specifications at any time without notification to the customer.

Micrel Products are not designed or authorized for use as components in life support appliances, devices or systems where malfunction of a product can reasonably be expected to result in personal injury. Life support devices or systems are devices or systems that (a) are intended for surgical implant into the body or (b) support or sustain life, and whose failure to perform can be reasonably expected to result in a significant injury to the user. A Purchaser's use or sale of Micrel Products for use in life support appliances, devices or systems is a Purchaser's own risk and Purchaser agrees to fully indemnify Micrel for any damages resulting from such use or sale.

© 2009 Micrel, Incorporated.