

Optocoupler, Non Zero Crossing Phototriac, 1.5 kV/ μ s dV/dt, 600 V

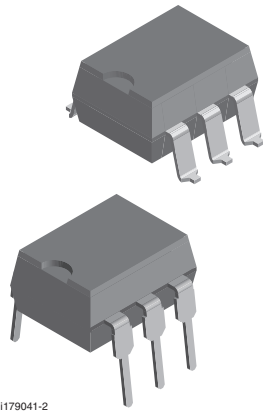

i179041-2

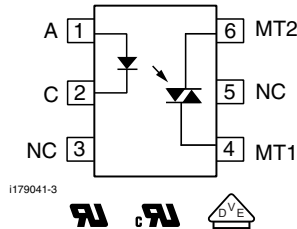

i179041-3



FEATURES

- 1500 V/ μ s dV/dt minimum 2000 V/ μ s typical
- 600 V blocking voltage
- 100 mA on-state current
- Low input trigger current
- 6 pin DIP package
- Compliant to RoHS Directive 2002/95/EC and in accordance to WEEE 2002/96/EC

RoHS
COMPLIANT

APPLICATIONS

- Household appliances
- Triac drive/AC motor drives
- Solenoid/valve controls
- Office automation equipment/machine
- Temperature (HVAC)/lighting controls
- Switching power supply

AGENCY APPROVALS

- UL-file E52744 system code H or J
- cUL - file no. E52744, equivalent to CSA bulletin 5A
- DIN EN 60747-5-5 (VDE 0884) available with option 1

DESCRIPTION

The VO3052 and VO3053 triac driver family consists of a GaAs infrared LED optically coupled to a monolithic photosensitive non zero crossing triac detector chip. The 600 V blocking voltage permits control of off-line voltages up to 240 V_{AC}, with a safety factor or more than two, and is sufficient for as much as 380 V.

ORDERING INFORMATION

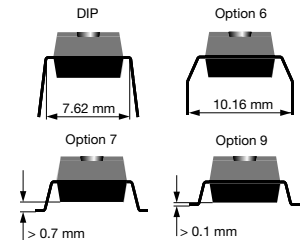
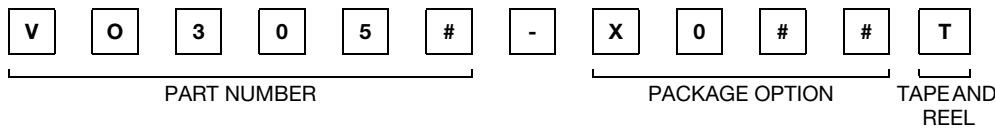

AGENCY CERTIFIED/PACKAGE	TRIGGER, CURRENT I _{FT} (mA)	
	5	10
UL, cUL, BSI		
DIP-6	VO3053	VO3052
DIP-6, 400 mil, option 6	VO3053-X006	VO3052-X006
SMD-6, option 7	VO3053-X007T	VO3052-X007T
SMD-6, option 9	VO3053-X009T	-
VDE, UL, cUL, BSI		
DIP-6, 400 mil, option 6	-	VO3052-X016

ABSOLUTE MAXIMUM RATINGS (1)					
PARAMETER	TEST CONDITION	PART	SYMBOL	VALUE	UNIT
INPUT					
Reverse voltage			V_R	6	V
Forward current - continuous			I_F	60	mA
Power dissipation			P_{diss}	100	mW
OUTPUT					
Off state output terminal voltage		VO3052, VO3053	V_{DRM}	600	V
Peak repetitive surge current	PW = 100 ms, 120 pps		I_{TSM}	1	A
Power dissipation			P_{diss}	200	mW
On-state RMS current			$I_{T(RMS)}$	100	mA
COUPLER					
Isolation test voltage	t = 1 s		V_{ISO}	5300	V_{RMS}
Total power dissipation			P_{tot}	300	mW
Operating temperature			T_{amb}	- 40 to + 100	°C
Storage temperature			T_{stg}	- 55 to + 150	°C
Soldering temperature (2)	10 s		T_{slid}	260	°C

Notes

(1) $T_{amb} = 25\text{ °C}$, unless otherwise specified.

Stresses in excess of the absolute maximum ratings can cause permanent damage to the device. Functional operation of the device is not implied at these or any other conditions in excess of those given in the operational sections of this document. Exposure to absolute maximum ratings for extended periods of the time can adversely affect reliability.

(2) Refer to reflow profile for soldering conditions for surface mounted devices (SMD). Refer to wave profile for soldering conditions for through hole devices (DIP).

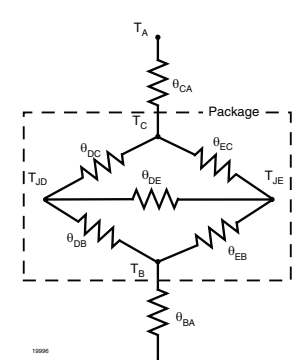
THERMAL CHARACTERISTICS (1)				
PARAMETER	SYMBOL	VALUE	UNIT	
Maximum LED junction temperature	$T_{jmax.}$	125	°C	
Maximum output die junction temperature	$T_{jmax.}$	125	°C	
Thermal resistance, junction emitter to board	θ_{JEB}	150	°C/W	
Thermal resistance, junction emitter to case	θ_{JEC}	139	°C/W	
Thermal resistance, junction detector to board	θ_{JDB}	78	°C/W	
Thermal resistance, junction detector to case	θ_{JDC}	103	°C/W	
Thermal resistance, junction emitter to junction detector	θ_{JED}	496	°C/W	
Thermal resistance, case to ambient	θ_{CA}	3563	°C/W	

Note

(1) The thermal model is represented in the thermal network below. Each resistance value given in this model can be used to calculate the temperatures at each node for a given operating condition. The thermal resistance from board to ambient will be dependent on the type of PCB, layout and thickness of copper traces. For a detailed explanation of the thermal model, please reference Vishay's Thermal Characteristics of Optocouplers application note.



Optocoupler, Non Zero Crossing Phototriac, 1.5 kV/μs dV/dt, 600 V Vishay Semiconductors

ELECTRICAL CHARACTERISTICS ($T_{amb} = 25\text{ }^{\circ}\text{C}$, unless otherwise specified)							
PARAMETER	TEST CONDITION	PART	SYMBOL	MIN.	TYP.	MAX.	UNIT
INPUT							
Reverse current	$V_R = 6\text{ V}$		I_R			10	μA
Forward voltage	$I_F = 30\text{ mA}$		V_F		1.2	1.5	V
OUTPUT							
Leakage with LED off, either direction	$V_{DRM} = 600\text{ V}$		I_{DRM}		10	500	nA
Critical rate of rise off-state voltage	$V_D = 400\text{ V}$		dV/dt_{cr}	1500	2000		V/μs
COUPLER							
LED trigger current, current required to latch output		VO3053	I_{FT}			5	mA
		VO3052	I_{FT}			10	mA
Peak on-state voltage, either direction	$I_{TM} = 100\text{ mA peak}$, $I_F = \text{rated } I_{FT}$		V_{TM}		1.7	3	V
Holding current, either direction			I_H		200		μA
Coupling capacitance	10 KHz		C_{IO}		0.4		pF

Note

- Typical values are characteristics of the device and are the result of engineering evaluations. Typical values are for information only and are not part of the testing requirements.

SAFETY AND INSULATION RATINGS (1)							
PARAMETER	TEST CONDITION	SYMBOL	MIN.	TYP.	MAX.	UNIT	
Climatic classification	IEC68 part 1			40/100/21			
Pollution degree	DIN VDE 0109			2			
Tracking resistance (comparative tracking index)	Insulation group IIIa	CTI	175				
Highest allowable overvoltage	Transient overvoltage	V_{IOTM}	8000			V_{peak}	
Maximum working insulation voltage	Recurring peak voltage	V_{IORM}	890			V_{peak}	
Insulation resistance at 25 °C	$V_{IO} = 500\text{ V}$	R_{IS}			$\geq 10^{12}$	Ω	
Insulation resistance at T_S	$V_{IO} = 500\text{ V}$	R_{IS}			$\geq 10^{12}$	Ω	
Insulation resistance at 100 °C	$V_{IO} = 500\text{ V}$	R_{IS}			$\geq 10^{12}$	Ω	
Partial discharge test voltage	Method a, $V_{pd} = V_{IORM} \times 1.875$	V_{pd}			1669	V_{peak}	
Safety limiting values - maximum values allowed in the event of a failure	Output power	P_{SO}			500	mW	
	Input current	I_{SI}			250	mA	
	Case temperature	T_{SI}			175	°C	
Minimum external air gap (clearance)	Measured from input terminals to output terminals, shortest distance through air		≥ 7			mm	
Minimum external tracking (creepage)	Measured from input terminals to output terminals, shortest distance path along body		≥ 7			mm	
Minimum external air gap (clearance)	Measured from input terminals to output terminals, shortest distance through air		≥ 8			mm	
Minimum external tracking (creepage)	Measured from input terminals to output terminals, shortest distance path along body		≥ 8			mm	

Note

(1) As per IEC60747-5-5, 7.4.3.8.1, this optocoupler is suitable for “safe electrical insulation” only within the safety ratings. Compliance with the safety ratings shall be ensured by means of protective circuits.

TYPICAL CHARACTERISTICS ($T_{amb} = 25\text{ }^{\circ}\text{C}$, unless otherwise specified)

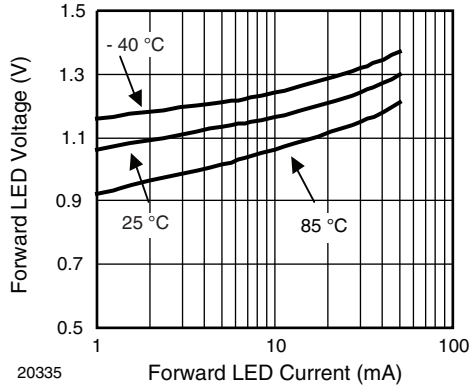

Fig. 1 - Forward Voltage vs. Forward Current

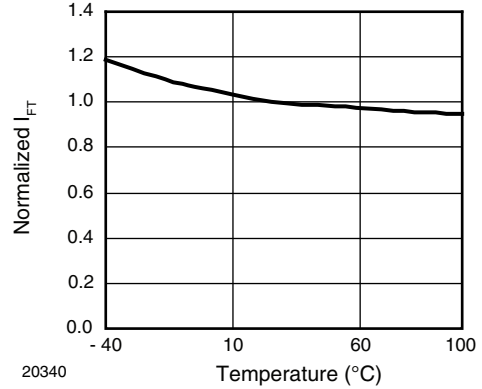

Fig. 4 - Normalized Trigger Current vs. Temperature

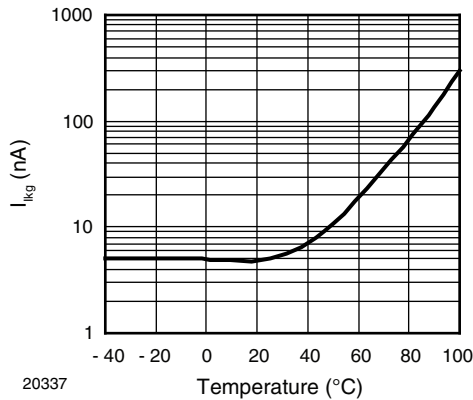

Fig. 2 - Off-State Leakage Current vs. Temperature

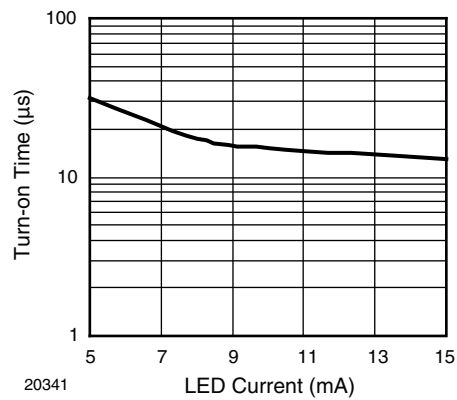

Fig. 5 - Turn-on Time vs. LED Current

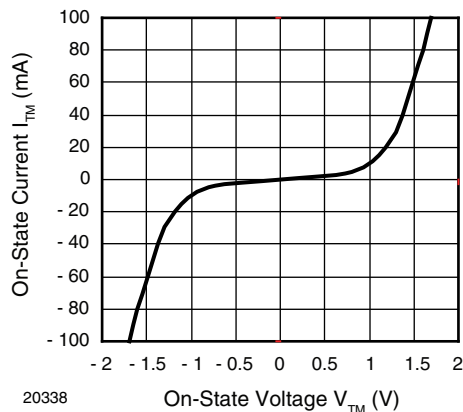

Fig. 3 - On-State Current vs. V_{TM}

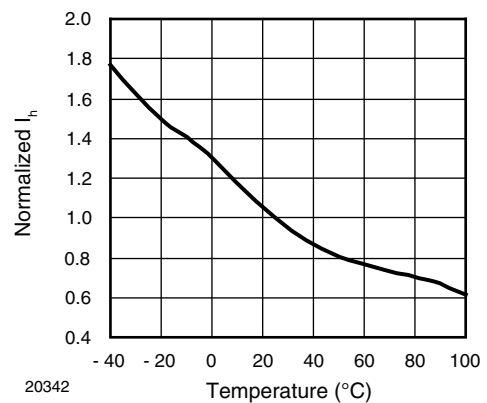

Fig. 6 - Normalized Holding Current vs. Temperature

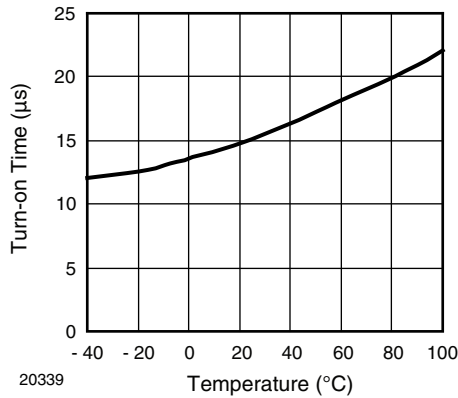

Fig. 7 - Turn-on Time vs. Temperature

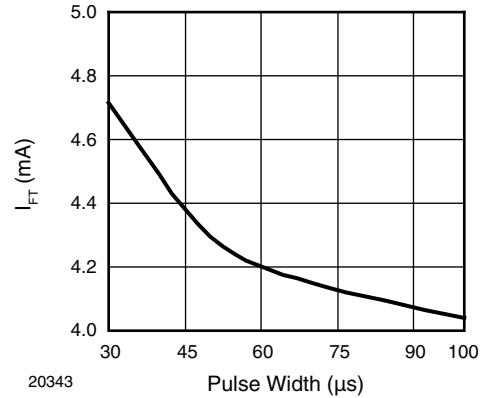
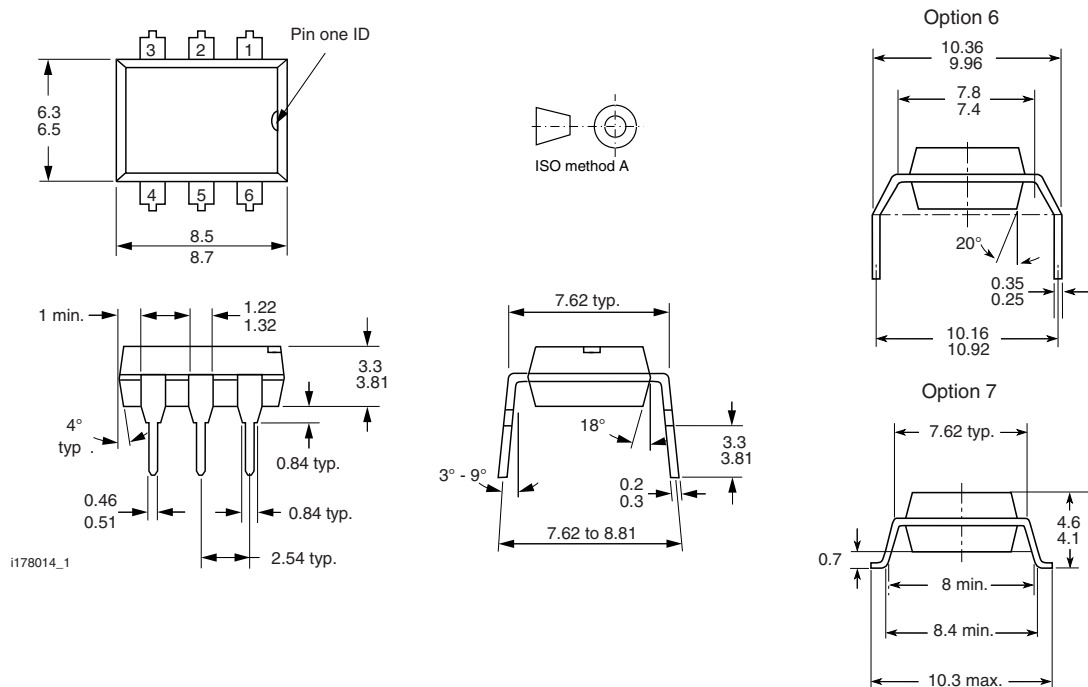
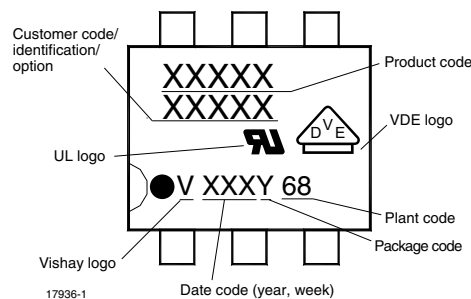

Fig. 8 - Trigger Current vs. Pulse Width

PACKAGE DIMENSIONS in millimeters



PACKAGE MARKING





Disclaimer

All product specifications and data are subject to change without notice.

Vishay Intertechnology, Inc., its affiliates, agents, and employees, and all persons acting on its or their behalf (collectively, "Vishay"), disclaim any and all liability for any errors, inaccuracies or incompleteness contained herein or in any other disclosure relating to any product.

Vishay disclaims any and all liability arising out of the use or application of any product described herein or of any information provided herein to the maximum extent permitted by law. The product specifications do not expand or otherwise modify Vishay's terms and conditions of purchase, including but not limited to the warranty expressed therein, which apply to these products.

No license, express or implied, by estoppel or otherwise, to any intellectual property rights is granted by this document or by any conduct of Vishay.

The products shown herein are not designed for use in medical, life-saving, or life-sustaining applications unless otherwise expressly indicated. Customers using or selling Vishay products not expressly indicated for use in such applications do so entirely at their own risk and agree to fully indemnify Vishay for any damages arising or resulting from such use or sale. Please contact authorized Vishay personnel to obtain written terms and conditions regarding products designed for such applications.

Product names and markings noted herein may be trademarks of their respective owners.