



High-Speed, Low-Voltage, Micropower Op Amps

MAX402/MAX403/MAX438/MAX439

General Description

The MAX402/MAX403/MAX438/MAX439 micropower op amps combine high-speed performance with low-power operation. The MAX402/MAX403 are compensated for unity-gain stability, while the MAX438/MAX439 are compensated for stability in applications with a closed-loop gain (A_{VCL}) of 5V/V or greater.

The MAX402/MAX438 require less than 75 μ A of supply current while delivering 2MHz bandwidth with 6V/ μ s slew rate (MAX402), and 6MHz gain bandwidth with 10V/ μ s slew rate (MAX438).

For applications requiring increased speed, the MAX403/MAX439 consume less than 375 μ A of supply current while delivering 10MHz gain bandwidth with 40V/ μ s slew rate (MAX403), and 25MHz gain bandwidth with 48V/ μ s slew rate (MAX439).

Applications

- Low-Power Signal Processing
- Filters
- Portable Instruments
- Remote Sensors

Typical Application Circuit

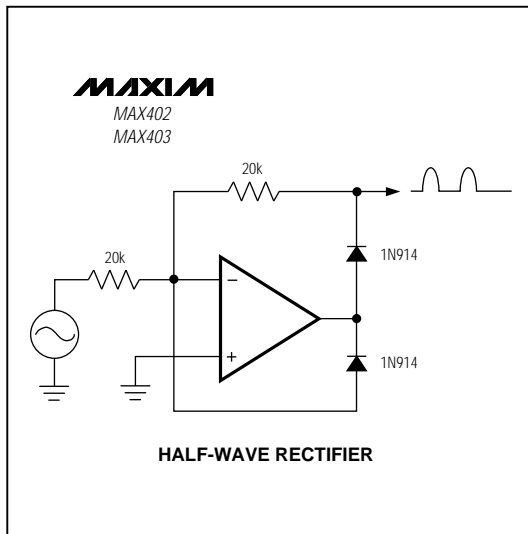

Features

MAX402

- ◆ 2MHz Unity-Gain Bandwidth
- ◆ 6V/ μ s Slew Rate
- ◆ 75 μ A Max Supply Current

MAX403

- ◆ 10MHz Unity-Gain Bandwidth
- ◆ 40V/ μ s Slew Rate
- ◆ 375 μ A Max Supply Current

MAX438

- ◆ 6MHz Gain Bandwidth ($A_{VCL} \geq 5V/V$)
- ◆ 10V/ μ s Slew Rate
- ◆ 75 μ A Max Supply Current

MAX439

- ◆ 25MHz Gain Bandwidth ($A_{VCL} \geq 5V/V$)
- ◆ 48V/ μ s Slew Rate
- ◆ 375 μ A Max Supply Current

Ordering Information

PART	TEMP. RANGE	PIN-PACKAGE
MAX402CPA	0°C to +70°C	8 Plastic DIP
MAX402CSA	0°C to +70°C	8 SO
MAX402C/D	0°C to +70°C	Dice*
MAX402EPA	-40°C to +85°C	8 Plastic DIP
MAX402ESA	-40°C to +85°C	8 SO

Ordering Information continued at end of data sheet.

* Dice are specified at $T_A = +25^\circ\text{C}$, DC parameters only.

Pin Configuration

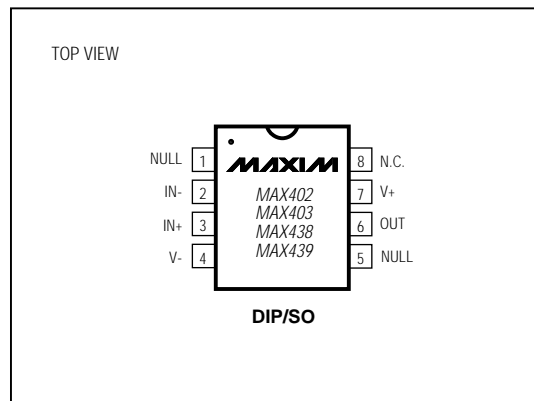

High-Speed, Low-Voltage, Micropower Op Amps

ABSOLUTE MAXIMUM RATINGS (Note 1)

Supply Voltage (V+ to V-)	12V
Input Voltage Range	(V+ + 0.3V) to (V- - 0.3V)
Differential Input Voltage	V+ to V-
Short-Circuit Current Duration	Indefinite
Maximum Current into Any Pin	50mA
Continuous Power Dissipation (TA = +25°C)	
Plastic DIP	375mW
SO	471mW

Operating Temperature Ranges

MAX40__C_	0°C to +70°C
MAX40__E_	-40°C to +85°C
Storage Temperature Range	-65°C to +150°C
Lead Temperature (soldering, 10sec)	+300°C

Note 1: Absolute maximum ratings apply to packaged parts only, unless otherwise noted.

Stresses beyond those listed under "Absolute Maximum Ratings" may cause permanent damage to the device. These are stress ratings only, and functional operation of the device at these or any other conditions beyond those indicated in the operational sections of the specifications is not implied. Exposure to absolute maximum rating conditions for extended periods may affect device reliability.

ELECTRICAL CHARACTERISTICS—MAX402/MAX403

(V+ = 5V, V- = -5V, TA = +25°C, unless otherwise noted.)

PARAMETER	SYMBOL	CONDITIONS	MAX402			MAX403			UNITS
			MIN	TYP	MAX	MIN	TYP	MAX	
Input Offset Voltage	V _{OS}		0.5	2.0	0.5	2.0		mV	
Offset Voltage Tempco $\Delta V_{OS}/\Delta T$	TCV _{OS}	T _A = T _{MIN} to T _{MAX}	25		25			$\mu V/^{\circ}C$	
Input Bias Current	I _B		± 2	± 5	± 10	± 25		nA	
Input Voltage Range	IVR		± 3.5	± 3.8	± 3.5	± 3.8		V	
Differential Input Resistance	R _{IN} (DIFF)		90		18			M Ω	
Common-Mode Input Resistance	R _{IN} (CM)		1		1			G Ω	
Input Noise-Voltage Density	e _n	f _o = 10Hz	43		33			nV \sqrt{Hz}	
		f _o = 1000Hz	26		14				
Input Noise-Current Density	i _n	f _o = 10Hz	0.06		0.25			pA \sqrt{Hz}	
		f _o = 1000Hz	0.03		0.07				
Common-Mode Rejection Ratio	CMRR	V _{CM} = $\pm 3.5V$	75	95	66	80		dB	
Power-Supply Rejection Ratio	PSRR	V _S = $\pm 4.5V$ to $\pm 5.5V$	56	65	60	70		dB	
Large-Signal Gain	A _{VOL}	R _L = 20k Ω	68	75		80		dB	
		R _L = 4k Ω			68	75			
Output Voltage Swing	V _{OUT}	R _L = 20k Ω	± 3.6	± 3.9	± 3.6	± 3.9		V	
		R _L = 4k Ω			± 3.3	± 3.6			
Short-Circuit Output Current	I _{SC}		3		5			mA	
Slew Rate (Note 2)	SR	20k Ω 20pF load	4.5	6	25	40		V/ μs	
Gain Bandwidth	GBW	20k Ω 20pF load	1.4	2	7	10		MHz	
Quiescent Current	I _Q		40	60	75	200	250	375	μA

High-Speed, Low-Voltage, Micropower Op Amps

MAX402/MAX403/MAX438/MAX439

ELECTRICAL CHARACTERISTICS – MAX402C/MAX403C

($V_+ = 5V$, $V_- = -5V$, $T_A = 0^\circ C$ to $+70^\circ C$, unless otherwise noted.)

PARAMETER	SYMBOL	CONDITIONS	MAX402C_A			MAX403C_A			UNITS
			MIN	TYP	MAX	MIN	TYP	MAX	
Input Offset Voltage	V_{OS}				4			4	mV
Input Bias Current	I_B				± 10			± 50	nA
Input Voltage Range	IVR		± 3.5			± 3.5			V
Common-Mode Rejection Ratio	CMRR	$V_{CM} = \pm 3.5V$	70			66			dB
Power-Supply Rejection Ratio	PSRR	$V_S = \pm 4.5V$ to $\pm 5.5V$	54			60			dB
Large-Signal Gain	A_{VOL}	$R_L = 20k\Omega$	60						dB
		$R_L = 4k\Omega$				60			
Output Voltage Swing	V_{OUT}	$R_L = 20k\Omega$	± 3.5			± 3.5			V
		$R_L = 4k\Omega$				± 3.2			
Slew Rate (Note 2)	SR	$20k\Omega 20pF$ load	4.0			22.5			V/ μs
Gain Bandwidth	GBW	$20k\Omega 20pF$ load	1.3			7			MHz
Quiescent Current	I_Q		35		90	175		450	μA

ELECTRICAL CHARACTERISTICS – MAX402E/MAX403E

($V_+ = 5V$, $V_- = -5V$, $T_A = -40^\circ C$ to $+85^\circ C$, unless otherwise noted.)

PARAMETER	SYMBOL	CONDITIONS	MAX402E_A			MAX403E_A			UNITS
			MIN	TYP	MAX	MIN	TYP	MAX	
Input Offset Voltage	V_{OS}				5			5	mV
Input Bias Current	I_B				± 20			± 100	nA
Input Voltage Range	IVR		± 3.5			± 3.5			V
Common-Mode Rejection Ratio	CMRR	$V_{CM} = \pm 3.5V$	68			66			dB
Power-Supply Rejection Ratio	PSRR	$V_S = \pm 4.5V$ to $\pm 5.5V$	52			58			dB
Large-Signal Gain	A_{VOL}	$R_L = 20k\Omega$	56						dB
		$R_L = 4k\Omega$				56			
Output Voltage Swing	V_{OUT}	$R_L = 20k\Omega$	± 3.4			± 3.4			V
		$R_L = 4k\Omega$				± 3.0			
Slew Rate (Note 2)	SR	$20k\Omega 20pF$ load	4.0			20			V/ μs
Gain Bandwidth	GBW	$20k\Omega 20pF$ load	1.2			6			MHz
Quiescent Current	I_Q		30		95	150		475	μA

Note 2: $\pm \Delta V_{IN} = 2V_{p-p}$.

High-Speed, Low-Voltage, Micropower Op Amps

MAX402/MAX403/MAX438/MAX439

ELECTRICAL CHARACTERISTICS – MAX438/MAX439

(V₊ = 5V, V₋ = -5V, T_A = +25°C, unless otherwise noted.)

PARAMETER	SYMBOL	CONDITIONS	MAX438			MAX439			UNITS
			MIN	TYP	MAX	MIN	TYP	MAX	
Input Offset Voltage	V _{OS}		0.5	2.0		0.5	2.0	mV	
Offset Voltage Tempco $\Delta V_{OS}/\Delta T$	TCV _{OS}	T _A = T _{MIN} to T _{MAX}	25			25			$\mu V/^{\circ}C$
Input Bias Current	I _B		± 2	± 5		± 5	± 25	nA	
Input Voltage Range	IVR		± 3.5	± 3.8		± 3.5	± 3.8	V	
Differential Input Resistance	R _{IN} (DIFF)		90			18			M Ω
Common-Mode Input Resistance	R _{IN} (CM)		1			1			G Ω
Input Noise-Voltage Density	e _n	f _o = 10Hz	43			33			nV/ \sqrt{Hz}
		f _o = 1000Hz	26			14			
Input Noise-Current Density	i _n	f _o = 10Hz	0.06			0.25			pA/ \sqrt{Hz}
		f _o = 1000Hz	0.03			0.07			
Common-Mode Rejection Ratio	CMRR	V _{CM} = $\pm 3.5V$	75	95		66	80	dB	
Power-Supply Rejection Ratio	PSRR	V _S = $\pm 4.5V$ to $\pm 5.5V$	56	65		60	70	dB	
Large-Signal Gain	AVOL	R _L = 20k Ω	68	75		80		dB	
		R _L = 4k Ω				68	75		
Output Voltage Swing	V _{OUT}	R _L = 20k Ω	± 3.6	± 3.9		± 3.6	± 3.9	V	
		R _L = 4k Ω				± 3.3	± 3.6		
Short-Circuit Output Current	I _{SC}		3			5			mA
Slew Rate (Note 3)	SR	20k Ω 20pF load	10			48			V/ μs
Gain Bandwidth	GBW	20k Ω 20pF load	4	6		18	25	MHz	
Quiescent Current	I _Q		40	60	75	200	250	375	μA
Minimum Closed-Loop Gain	AVCL		± 5			± 5			V/V

ELECTRICAL CHARACTERISTICS – MAX438C/MAX439C

(V₊ = 5V, V₋ = -5V, T_A = 0°C to +70°C, unless otherwise noted.)

PARAMETER	SYMBOL	CONDITIONS	MAX438C_A			MAX439C_A			UNITS		
			MIN	TYP	MAX	MIN	TYP	MAX			
Input Offset Voltage	V _{OS}				4			4	mV		
Input Bias Current	I _B				± 10			± 50	nA		
Input Voltage Range	IVR		± 3.5			± 3.5			V		
Common-Mode Rejection Ratio	CMRR	V _{CM} = $\pm 3.5V$	70			66			dB		
Power-Supply Rejection Ratio	PSRR	V _S = $\pm 4.5V$ to $\pm 5.5V$	54			60			dB		
Large-Signal Gain	AVOL	R _L = 20k Ω	60						dB		
		R _L = 4k Ω				60					
Output Voltage Swing	V _{OUT}	R _L = 20k Ω	± 3.5			± 3.5			V		
		R _L = 4k Ω				± 3.2					
Slew Rate (Note 3)	SR	20k Ω 20pF load	7			40			V/ μs		
Gain Bandwidth	GBW	20k Ω 20pF load	3.7			16.5			MHz		
Quiescent Current	I _Q		35			90			175	450	μA
Minimum Closed-Loop Gain	AVCL		± 5			± 5			V/V		

High-Speed, Low-Voltage, Micropower Op Amps

MAX402/MAX403/MAX438/MAX439

ELECTRICAL CHARACTERISTICS – MAX438E/MAX439E

($V_+ = 5V$, $V_- = -5V$, $T_A = -40^\circ C$ to $+85^\circ C$, unless otherwise noted.)

PARAMETER	SYMBOL	CONDITIONS	MAX438E_A			MAX439E_A			UNITS
			MIN	TYP	MAX	MIN	TYP	MAX	
Input Offset Voltage	V_{OS}			5			5		mV
Input Bias Current	I_B			± 20			± 100		nA
Input Voltage Range	IVR		± 3.5			± 3.5			V
Common-Mode Rejection Ratio	CMRR	$V_{CM} = \pm 3.5V$	68			66			dB
Power-Supply Rejection Ratio	PSRR	$V_S = \pm 4.5V$ to $\pm 5.5V$	52			58			dB
Large-Signal Gain	AV_{OL}	$R_L = 20k\Omega$	56						dB
		$R_L = 4k\Omega$				56			
Output Voltage Swing	V_{OUT}	$R_L = 20k\Omega$	± 3.4			± 3.4			V
		$R_L = 4k\Omega$				± 3.0			
Slew Rate (Note 3)	SR	20k Ω 20pF load		7		40			V/ μs
Gain Bandwidth	GBW	20k Ω 20pF load	3.4			15			MHz
Quiescent Current	I_Q		30	95		150	475		μA
Minimum Closed-Loop Gain	AV_{CL}		± 5			± 5			V/V

Note 3: $\pm \Delta V_{IN} = 1V_{p-p}$.

Typical Operating Characteristics

($T_A = +25^\circ C$, unless otherwise noted.)

**MAX402
SMALL-SIGNAL TRANSIENT
RESPONSE**

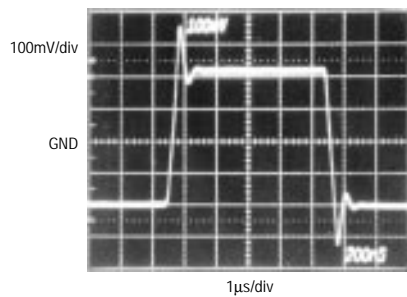

NONINVERTING, $AV_{CL} = +1$
 $V_{SUPPLY} = \pm 5V$, $R_L = 10k\Omega$ || 10pF

**MAX402
LARGE-SIGNAL TRANSIENT
RESPONSE**

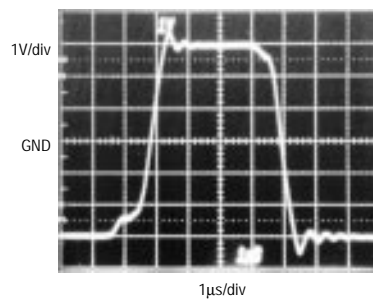

NONINVERTING, $AV_{CL} = +1$
 $V_{SUPPLY} = \pm 5V$, $R_L = 10k\Omega$ || 100pF

High-Speed, Low-Voltage, Micropower Op Amps

Typical Operating Characteristics (continued)

(T_A = +25°C, unless otherwise noted.)

**MAX403
SMALL-SIGNAL TRANSIENT
RESPONSE**

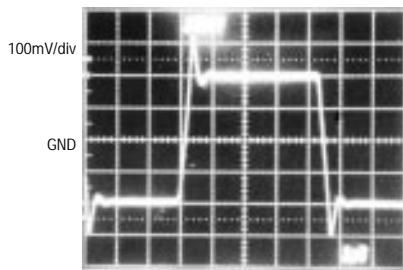

200ns/div
NONINVERTING, A_{VCL} = +1
V_{SUPPLY} = ±5V, R_L = 2kΩ || 10pF

**MAX403
LARGE-SIGNAL TRANSIENT
RESPONSE**

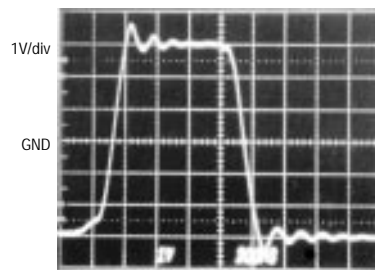

200ns/div
NONINVERTING, A_{VCL} = +1
V_{SUPPLY} = ±5V, R_L = 2kΩ || 100pF

**MAX438
PULSE RESPONSE**

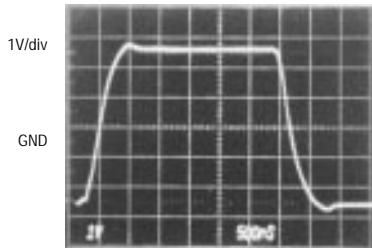

500ns/div
NONINVERTING,
A_{VCL} = +5V/V, R_L = 10kΩ || 20pF

**MAX439
PULSE RESPONSE**

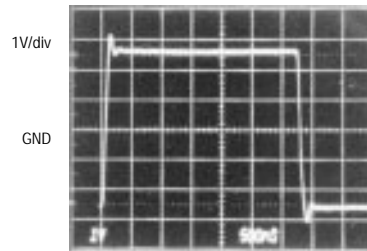

500ns/div
NONINVERTING,
A_V = +5V/V, R_L = 10kΩ || 20pF

High-Speed, Low-Voltage, Micropower Op Amps

Typical Operating Characteristics (continued)

($T_A = +25^\circ\text{C}$, unless otherwise noted.)

MAX402/MAX403/MAX438/MAX439

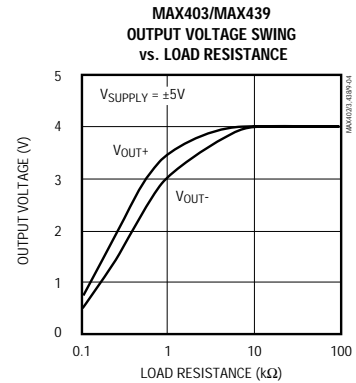
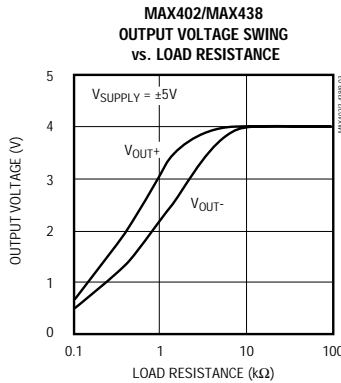
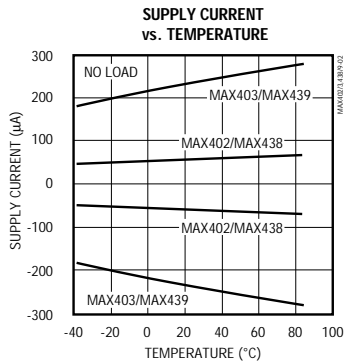
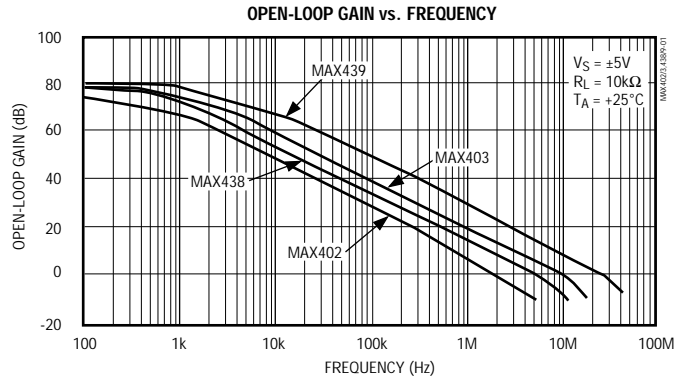

High-Speed, Low-Voltage, Micropower Op Amps

MAX402/MAX403/MAX438/MAX439

Typical Operating Characteristics (continued)

($T_A = +25^\circ\text{C}$, unless otherwise noted.)

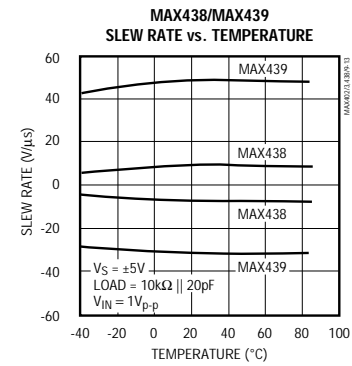
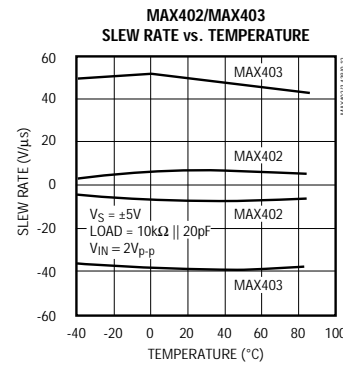
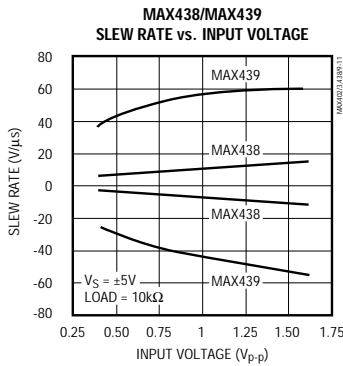
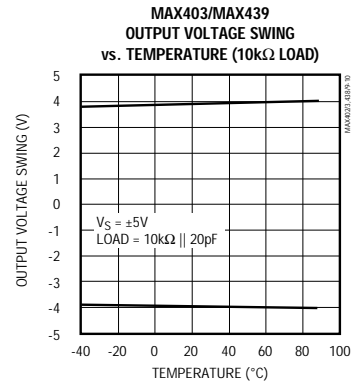
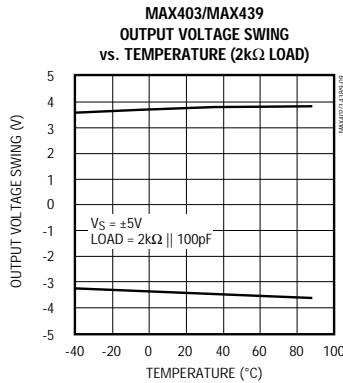
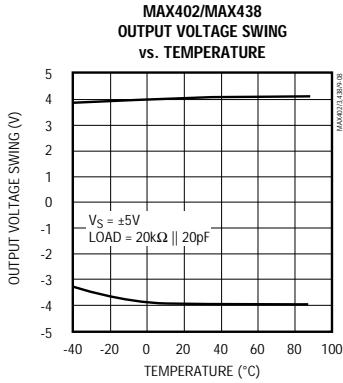
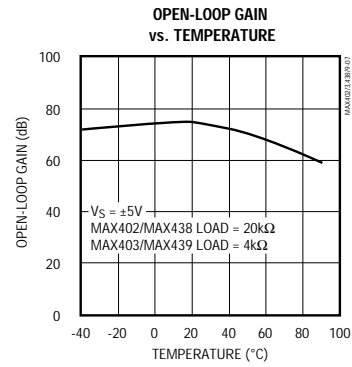
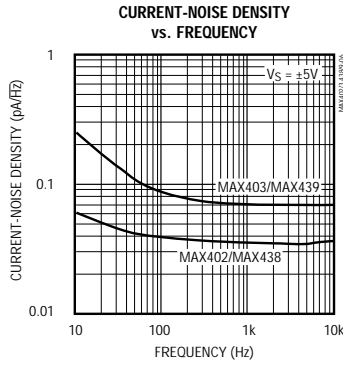
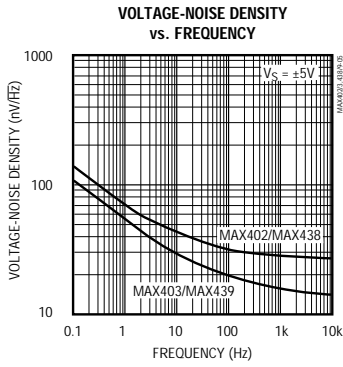

High-Speed, Low-Voltage, Micropower Op Amps

Typical Operating Characteristics (continued)

($T_A = +25^\circ\text{C}$, unless otherwise noted.)

MAX402/MAX403/MAX438/MAX439

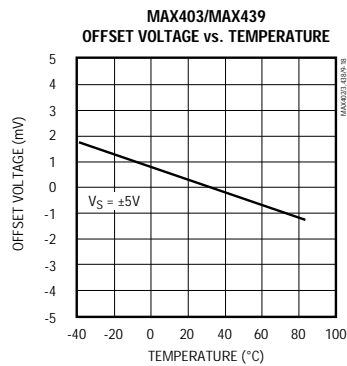
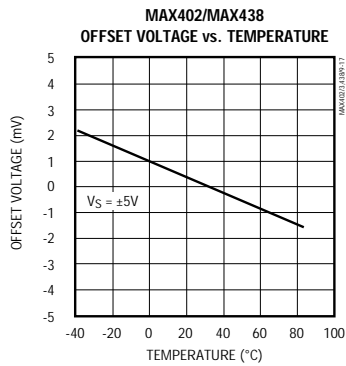
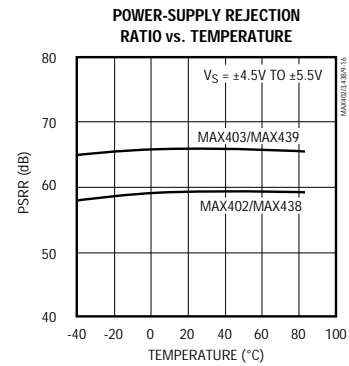
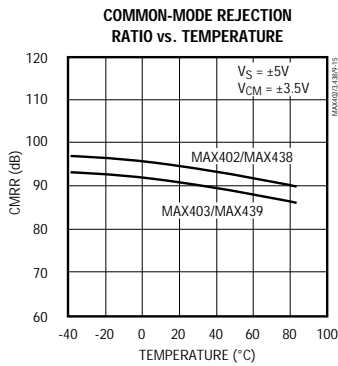
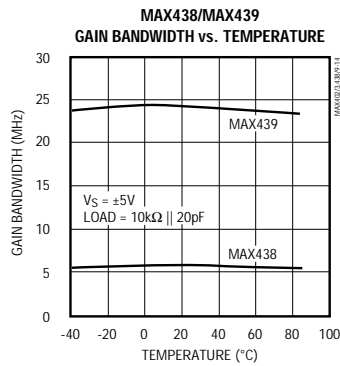

High-Speed, Low-Voltage, Micropower Op Amps

Pin Description

PIN	NAME	FUNCTION
1, 5	NULL	Offset-Voltage Adjustment
2	IN-	Inverting Input
3	IN+	Noninverting Input
4	V-	Negative Power Supply (VEE)
6	OUT	Amplifier Signal Output
7	V+	Positive Power Supply (VCC)
8	N.C.	No Connect—no internal connection

Applications Information

Input Offset-Voltage Adjustment

The NULL pins (1 and 5) can be used to null the input offset voltage. To adjust the amplifier's offset voltage, connect a potentiometer between the two NULL pins with the wiper connected to V-, as shown in Figure 1. Use a 10k Ω potentiometer with the MAX402/MAX438, and a 2k Ω potentiometer with the MAX403/MAX439. Offset voltage can be adjusted over a range of approximately 12mV with these trim potentiometers.

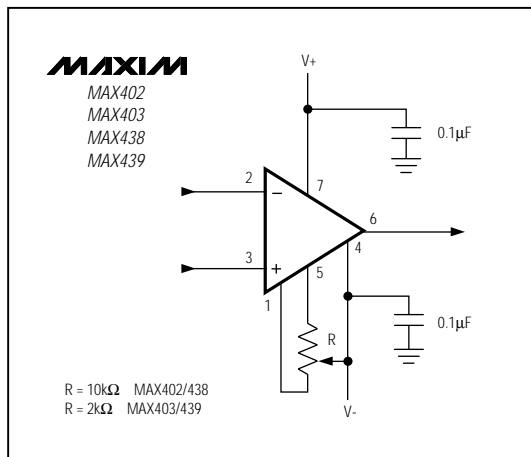

Figure 1. Offset-Voltage Adjustment

Operating Supply Voltage

The MAX402/MAX403/MAX438/MAX439 are specified with $\pm 5V$ power supplies, but also operate with dual supplies down to $\pm 3V$ or single supplies ranging from +6V to +10V if the common-mode input voltage is kept between (V- + 1.5V) and (V+ - 1.5V). With a single +6V supply, the common-mode input voltage ranges between +1.5V and +4.5V.

Layout and Bypassing

Bypass the power-supply inputs with 0.1 μF ceramic capacitors positioned as close to the power-supply pins as possible. To maximize performance in high-speed applications, use a ground plane. Connections to the amplifier's input terminals should be as short and direct as possible with a minimum of inductance and capacitance. Stray capacitance at the input terminals adds to the amplifier's approximate 3pF input capacitance, and can limit overall bandwidth. Also, minimize lead lengths in connections from the power-supply bypass capacitors to ground to further reduce inductance. Surface-mount (chip) capacitors are ideal for this application.

Slew Rate vs. Input Voltage

Like most high-speed op amps, the slew rate of the MAX402/MAX403/MAX438/MAX439 depends on the signal level driving the amplifier inputs. Slew-rate limiting in high-speed circuits becomes more significant as the amplifier's closed-loop gain increases (inadequate gain bandwidth is more likely to limit performance in low-gain circuits). For this reason, the MAX438/MAX439 have been characterized for slew rate vs. input voltage, as shown in the MAX438/MAX439 Slew Rate vs. Input Voltage graph in the *Typical Operating Characteristics*.

Overload Conditions

The amplifier inputs withstand differential voltages equal to the power-supply rails without requiring external clamp diodes or input current-limiting resistors. Schottky diodes, used internally throughout the devices, prevent saturation of the internal transistors and allow the amplifiers to recover quickly from overload conditions.

Many op amps exhibit phase reversal at the output when the input common-mode voltage range is exceeded—a potentially serious problem in servo-control systems. Phase reversal protection circuitry in the MAX402/MAX403/MAX438/MAX439 eliminates this problem for any input voltage level.

Each amplifier's output stage employs a current-limit circuit that prevents amplifier damage in the event of a fault condition. The output may be shorted to either power supply or ground continuously without damage.

High-Speed, Low-Voltage, Micropower Op Amps

_Ordering Information (continued)

PART	TEMP. RANGE	PIN-PACKAGE
MAX403 CPA	0°C to +70°C	8 Plastic DIP
MAX403CSA	0°C to +70°C	8 SO
MAX403C/D	0°C to +70°C-	Dice*
MAX403EPA	-40°C to +85°C	8 Plastic DIP
MAX403ESA	-40°C to +85°C	8 SO
MAX438 CPA	0°C to +70°C	8 Plastic DIP
MAX438CSA	0°C to +70°C	8 SO
MAX438C/D	0°C to +70°C-	Dice*
MAX438EPA	-40°C to +85°C	8 Plastic DIP
MAX438ESA	-40°C to +85°C	8 SO
MAX439 CPA	0°C to +70°C	8 Plastic DIP
MAX439CSA	0°C to +70°C	8 SO
MAX439C/D	0°C to +70°C-	Dice*
MAX439EPA	-40°C to +85°C	8 Plastic DIP
MAX439ESA	-40°C to +85°C	8 SO

* Dice are specified at $T_A = +25^\circ\text{C}$, DC parameters only.

Chip Topography

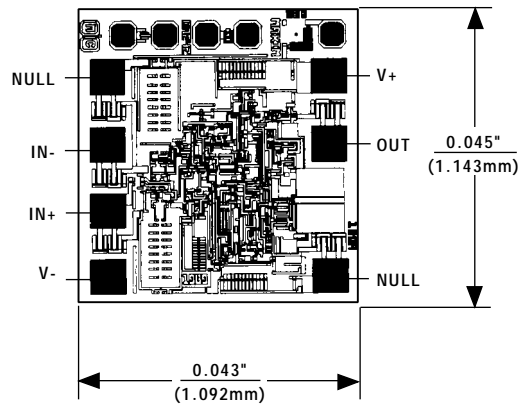

SUBSTRATE CONNECTS TO V-.
TRANSISTOR COUNT: 82

MAX402/MAX403/MAX438/MAX439

High-Speed, Low-Voltage, Micropower Op Amps

Package Information

**Plastic DIP
PLASTIC
DUAL-IN-LINE
PACKAGE
(0.300 in.)**

DIM	INCHES		MILLIMETERS	
	MIN	MAX	MIN	MAX
A	—	0.200	—	5.08
A1	0.015	—	0.38	—
A2	0.125	0.175	3.18	4.45
A3	0.055	0.080	1.40	2.03
B	0.016	0.022	0.41	0.56
B1	0.045	0.065	1.14	1.65
C	0.008	0.012	0.20	0.30
D1	0.005	0.080	0.13	2.03
E	0.300	0.325	7.62	8.26
E1	0.240	0.310	6.10	7.87
e	0.100	—	2.54	—
eA	0.300	—	7.62	—
eB	—	0.400	—	10.16
L	0.115	0.150	2.92	3.81

DIM	PINS	INCHES		MILLIMETERS	
		MIN	MAX	MIN	MAX
D	8	0.348	0.390	8.84	9.91
D	14	0.735	0.765	18.67	19.43
D	16	0.745	0.765	18.92	19.43
D	18	0.885	0.915	22.48	23.24
D	20	1.015	1.045	25.78	26.54
D	24	1.14	1.265	28.96	32.13

**SO
SMALL OUTLINE
PACKAGE
(0.150 in.)**

DIM	INCHES		MILLIMETERS	
	MIN	MAX	MIN	MAX
A	0.053	0.069	1.35	1.75
A1	0.004	0.010	0.10	0.25
B	0.014	0.019	0.35	0.49
C	0.007	0.010	0.19	0.25
E	0.150	0.157	3.80	4.00
e	0.050		1.27	
H	0.228	0.244	5.80	6.20
L	0.016	0.050	0.40	1.27

DIM	PINS	INCHES		MILLIMETERS	
		MIN	MAX	MIN	MAX
D	8	0.189	0.197	4.80	5.00
D	14	0.337	0.344	8.55	8.75
D	16	0.386	0.394	9.80	10.00

21-0041A

Maxim cannot assume responsibility for use of any circuitry other than circuitry entirely embodied in a Maxim product. No circuit patent licenses are implied. Maxim reserves the right to change the circuitry and specifications without notice at any time.

12 Maxim Integrated Products, 120 San Gabriel Drive, Sunnyvale, CA 94086 (408) 737-7600