

RoHS Compliant Product

Description

The ST2123 series of positive, linear regulators feature low quiescent current (35µA typ.) with low dropout voltage, making them ideal for battery applications. These rugged devices have both Thermal Shutdown, and Current Fold-back to prevent device failure under the "Worst" of operating conditions. The SOT-26 version also features a "Power Good" detector, which pulls low when the output is out of regulation. The ST2123 is stable with an output capacitance of 2.2µF or greater.

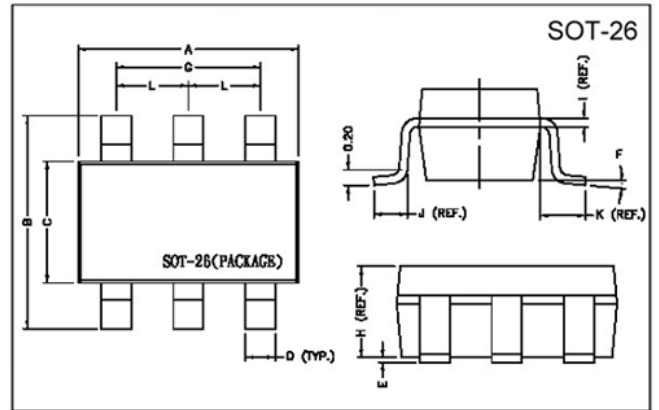

REF.	Millimeter		REF.	Dimensions Millimeter
	Min.	Max.		
A	2.70	3.10	G	1.90 REF.
B	2.60	3.00	H	1.20 REF.
C	1.40	1.80	I	0.12 REF.
D	0.30	0.55	J	0.37 REF.
E	0	0.10	K	0.60 REF.
F	0°	10°	L	0.95 REF.

Features

- * High Accurate ±1.5%
- * Over-Temperature Shutdown
- * Adjustable Output Voltage
- * Very Low Dropout Voltage
- * Low Temperature Coefficient
- * Short Circuit Current Fold-back
- * Guaranteed 300mA output
- * Current Limiting
- * Power Good Detector
- * Power-Saving Shutdown Mode

Applications

- * PC Peripherals
- * Wireless Devices
- * Portable Electronics
- * Battery Powered Widgets
- * Electronic Scales
- * Instrumentation
- * Cordless Phones

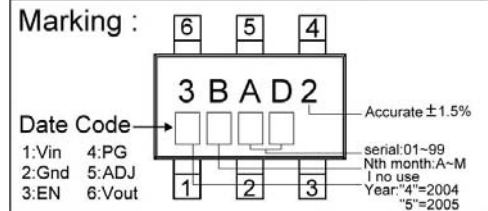

Typical Application Circuit

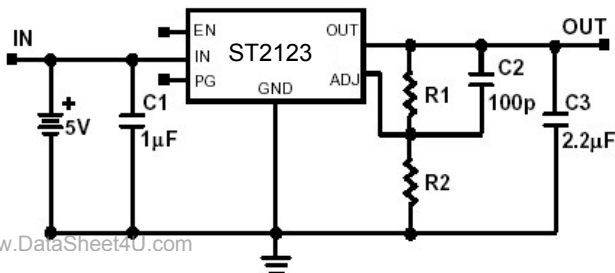

Functional Block Diagram

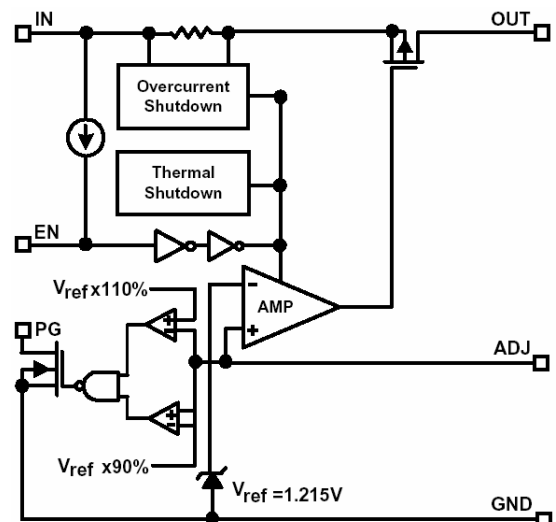

Absolute Maximum Ratings

Parameter	Symbol	Ratings	Unit
Input Voltage	V_{IN}	8	V
Output Current	I_{OUT}	$P_D/(V_{IN}-V_O)$	mA
Input, Output Voltage		GND-0.3 to $V_{IN}+0.3$	V
Operating Ambient Temperature	T_{opr}	-40~+85	°C
Junction Temperature	T_j	-40~+125	°C
Max. Junction Temperature	$T_j \text{ Max.}$	150	°C
Thermal Resistance	θ_{ja}	260	°C/W
Power Dissipation ($\Delta T=100^\circ\text{C}$)	P_D	380	mW
EDS Classification		B	

Electrical Characteristics $T_a=25^\circ\text{C}$ unless otherwise noted

Parameter	Symbol	Min.	Typ.	Max.	Unit	Condition	
Output Voltage	V_O	-1.5%	-	1.5%	V	$V_{IN}=5V, I_O=1mA$	
Ground Pin Current	I_{GND}	-	35	-	uA	$V_{IN}=5V, I_O=1mA\sim 300mA$	
Output Current	I_O	300	-	-	mA	$V_{IN}=5V, I_O>1.2$	
Current Limit	I_{LIM}	300	450	-	mA	$V_{IN}=5V, I_O>1.2$	
Load Regulation	REG_{LOAD}	-	0.2	1	%	$V_{IN}=5V, I_O=1mA\sim 300mA$	
Dropout Voltage	$V_{DROPOUT}$	-	-	1300	mV	$1.5V < V_{ON(NOM)} \leq 2.0V$	$I_O=300mA$ $V_O=V_{ON(NOM)}-2\%$
		-	-	400		$2.0V < V_{ON(NOM)} \leq 2.8V$	
		-	-	300		$2.8V < V_{ON(NOM)} < 3.8V$	
Line Regulation	REG_{LINE}	-	-	0.15	%	$V_O < 2.0V$	$I_O=5mA$ $V_{IN}=V_{OUT(T)}+1$ to $V_{OUT(T)}+2$
		-	0.02	0.1		$V_O \geq 2.0V$	
Input Voltage	V_{IN}	Note ¹	-	7	V		
Over Temperature Shutdown	O_{TS}	-	150	-	°C		
Over Temperature Hysteresis	O_{TH}	-	30	-	°C		
Output Voltage Temperature Coefficient	T_C	-	30	-	ppm/°C		
Short Circuit Current ²	I_{SC}	-	150	300	mA	$V_{IN}=5V, V_{OUT}<0.8V$	
Power Supply Rejection	PSRR	-	60	-	dB	$f=100Hz$	$V_{IN}=5V$ $I_O=100mA$ $C_O=2.2Mf$
		-	50	-		$f=1kHz$	
		-	20	-		$f=10kHz$	
Output Voltage Noise	e_N	-	30	-	uVrms	$C_O=2.2uF$ $f=10Hz\sim 100kHz$ $I_O=10mA$ $C_{BYP}=0uF$	
EN Input Threshold	V_{EH}	2	-	V_{IN}	V	$V_{IN}=2.7V$ to $7V$	
	V_{EL}	0	-	0.4			
EN Input Bias Current	I_{EH}	-	-	0.1	uA	$V_{EN}=V_{IN}, V_{IN}=2.7V$ to $7V$	
	I_{EL}	-	-	0.5		$V_{EN}=0V, V_{IN}=2.7V$ to $7V$	
Shutdown Supply Current	I_{SD}	-	0.5	1	uA	$V_{IN}=5V, V_O=0V, V_{EN}<V_{EL}$	
Shutdown Output Voltage	$V_{O,SD}$	0	-	0.1	V	$I_O=35uA, V_{EN}<V_{EL}$	
Output Under Voltage	V_{UV}	-	-	85	% $V_{ON(NOM)}$		
Output Over Voltage	V_{OV}	115	-	-	% $V_{ON(NOM)}$		
ADJ Input Bias Current	I_{ADJ}	-	1.0	-	uA		
ADJ Reference Voltage	V_{REF}	1.2	1.215	1.23	V		
PG Leakage Current	I_{LC}	-	-	1	uA	$V_{PG}=7V$	
PG Voltage Rating	V_{PG}	-	-	7	V	V_O in regulation	
PG Voltage Low	V_{OL}	-	-	0.4	V	$I_{SINK}=0.4mA$	

Note: 1. $V_{IN(MON)} = V_{OUT} + V_{DROPOUT}$
 2. To prevent the Short Current protection feature from being prematurely activated, the input voltage must be applied before a current source load is applied.

Ordering Information(contd.)

Part Number	Marking	Output Voltage	Part Number	Marking	Output Voltage
ST2123-AD	3BAD2 XXXX	Adjustable			

Detailed Description

The ST2123 of COMS regulators contain a PMOS pass transistor, voltage reference, error amplifier, over-current protection and thermal shutdown and Power Good detection circuitry. The P-channel pass transistor receives data from the error amplifier, over-current shutdown, and thermal protection circuits. During normal operation, the error amplifier compares the output voltage to a precision reference. Over-current and Thermal shutdown circuits become active when the junction temperature exceeds 150°C, or the current exceeds 300mA. During thermal shutdown, the output voltage remains low. Normal operation is restored when the junction temperature drops below 120°C. The ST2123 switches from voltage mode to current mode when the load exceeds the rated output current. This prevents over-stress. The ST2123 also incorporates current fold-back to reduce power dissipation when the output is short circuited. This feature becomes active when the output drops below 0.8 volts, and reduces the current flow by 65%. Full current is restored when the voltage exceeds 0.8 volts.

External Capacitors

The ST2123 is stable with an output capacitance to ground of 2.2uF or greater. Ceramic capacitors have the lowest ESR, and will offer the best AC performance. Conversely, Aluminum Electrolytic capacitors exhibit the highest ESR, resulting in the poorest AC response. Unfortunately, large value ceramic capacitors are comparatively expensive. One option is to parallel a 0.1 uF ceramic capacitor with a 10 uF Aluminum Electrolytic. The benefit is low ESR, high capacitance, and low overall cost. A second capacitor is recommended between the input and ground to stabilize Vin. The input capacitor should be at least 0.1uF to have a beneficial effect. All capacitors should be placed in close proximity to the pins. A "Quiet" ground termination is desirable. This can be achieved with a "Star" connection.

Enable

The Enable pin normally floats high. When actively, pulled low, the PMOS pass transistor shuts off, and all internal circuits are powered down. In this state, the quiescent current is less than 1uA. This pin behaves much like an electronic switch.

Power Good

The ST2123 includes the Power Good feature. When the output is not within ± 10% of the specified voltage, it pulls low. This can occur under the following conditions:

1. Input voltage too low
 2. During over-temperature
 3. During over-current
 4. If output is pulled up
- (note: PG pin is an open-drain output)

Characteristics Curve

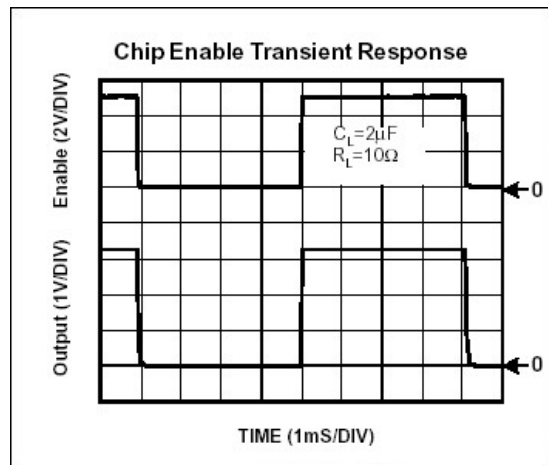
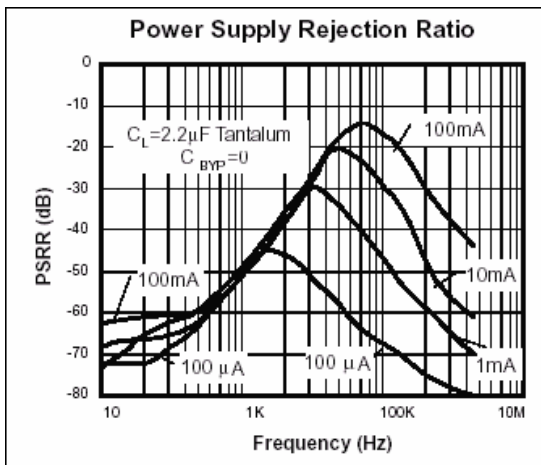
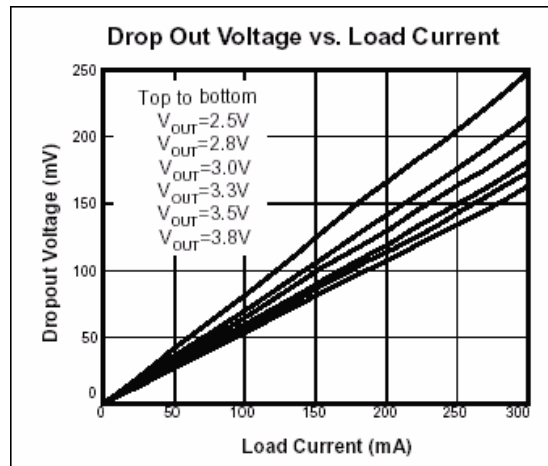
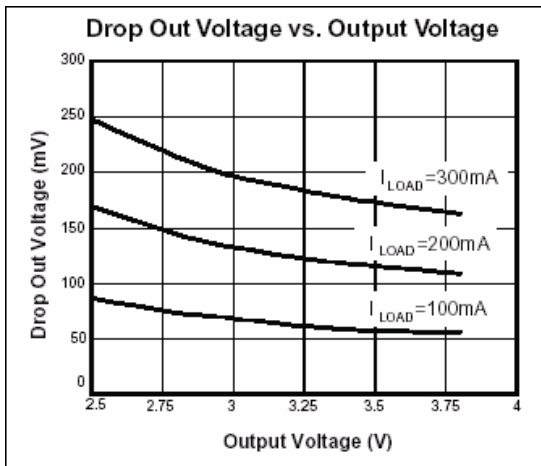
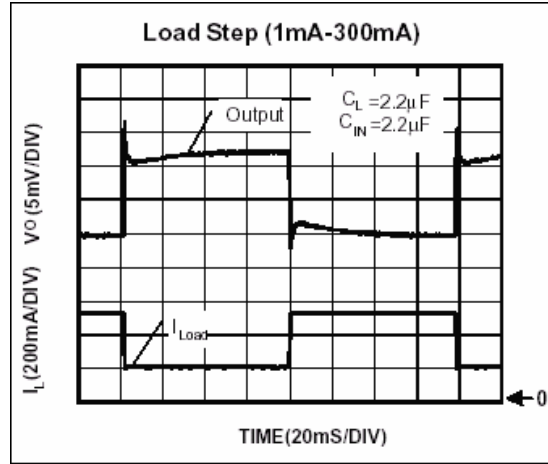
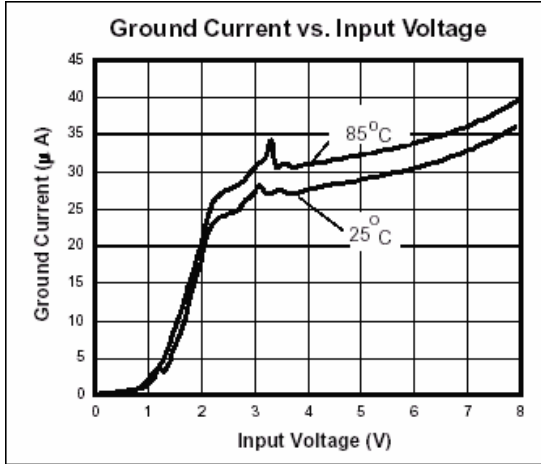

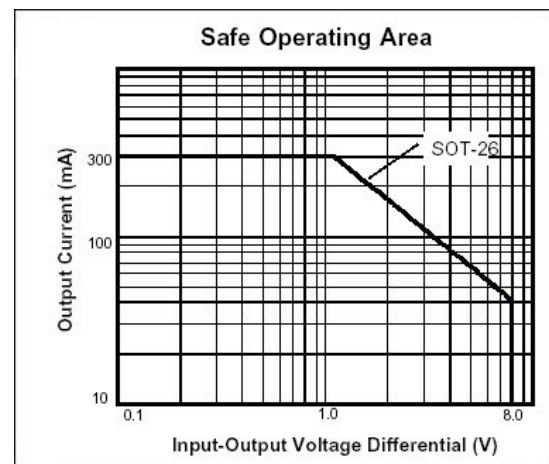
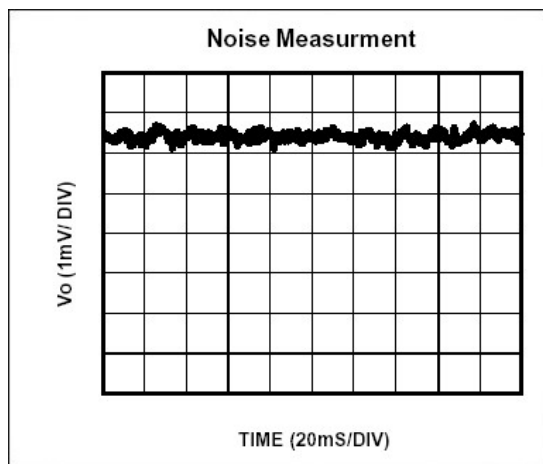
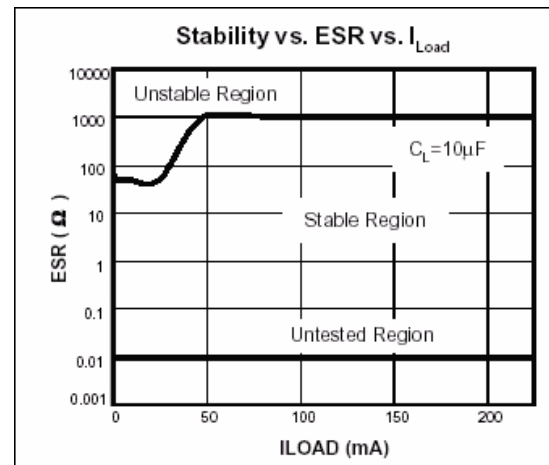
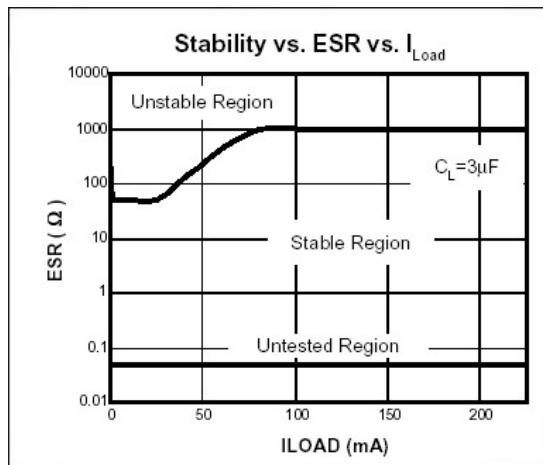
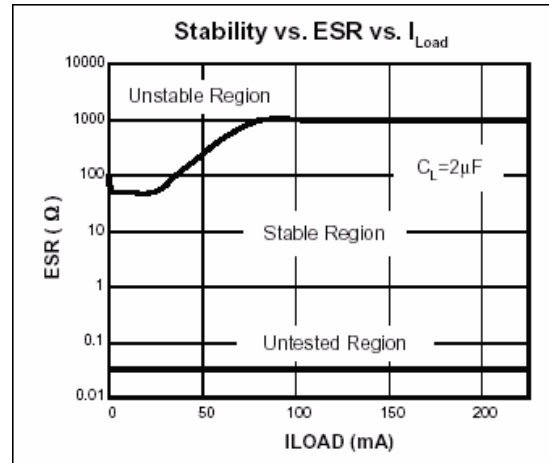
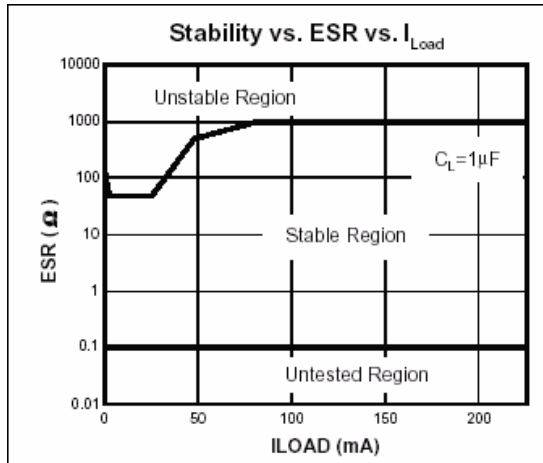



Elektronische Bauelemente

ST2123

CMOS Positive
Voltage Regulator

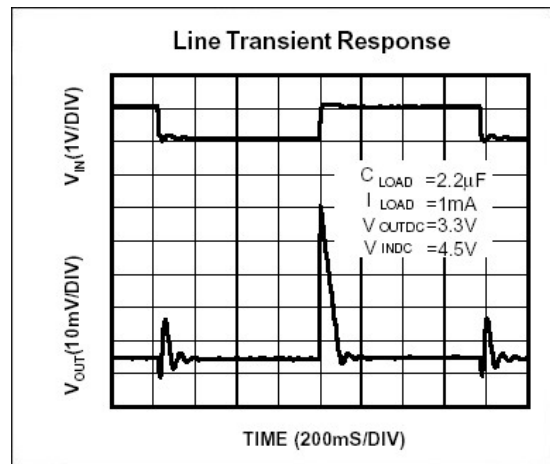
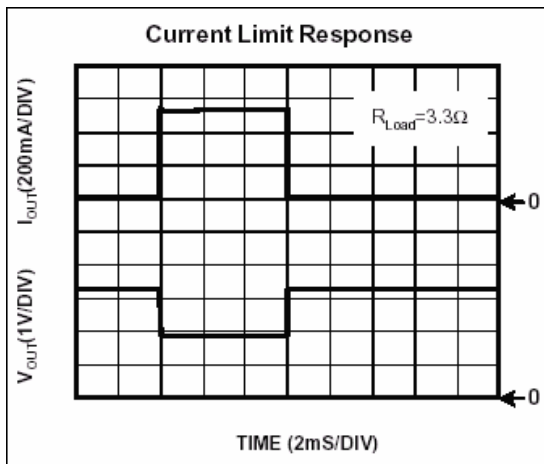
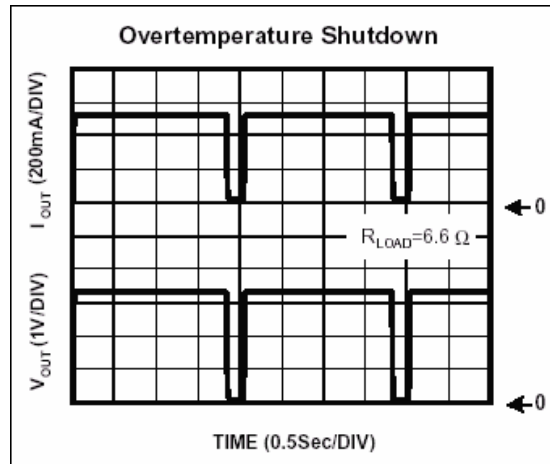
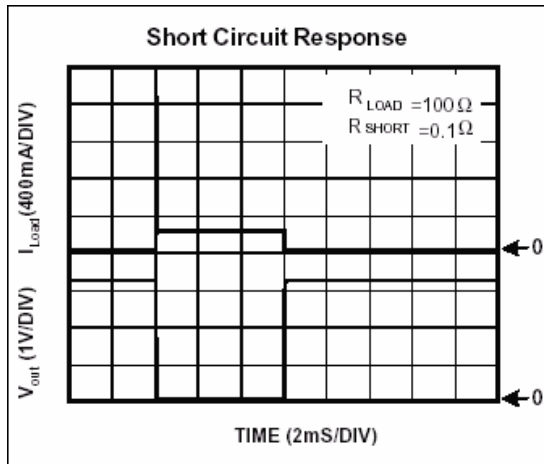



Elektronische Bauelemente

ST2123

CMOS Positive
Voltage Regulator

External Resistor Divider Table

R1(K Ohm)	1	2	5	10	20	50	100	200	500	1000
Vout	$R2(K\ Ohm)=(1.215*R1(K\ Ohm))/(VOUT-1.215)$									
1.30	14.29	28.59	71.47	142.94	285.88	714.71				
1.35	9.00	18.00	45.00	90.00	180.00	450.00				
1.40	6.57	13.14	32.84	65.68	131.35	328.38				
1.45	5.17	10.34	25.85	51.70	103.40	258.51	517.02			
1.50	4.26	8.53	21.32	42.63	85.26	213.16	426.32	852.63		
1.55	3.63	7.25	18.13	36.27	72.54	181.34	362.69	725.37		
1.60	3.16	6.31	15.78	31.56	63.12	157.79	315.58	631.17		
1.65	2.79	5.59	13.97	27.93	55.86	139.66	279.31	558.62		
1.70	2.51	5.01	12.53	25.05	50.10	125.26	250.52	501.03		
1.75	2.27	4.54	11.36	22.71	45.42	113.55	227.10	454.21		
1.80	2.08	4.15	10.38	20.77	41.54	103.85	207.69	415.38		
1.85	1.91	3.83	9.57	19.13	38.27	95.67	191.34	382.68		
1.90	1.77	3.55	8.87	17.74	35.47	88.69	177.37	354.74		
1.95	1.65	3.31	8.27	16.53	33.06	82.65	165.33	330.61	826.53	
2.00	1.55	3.10	7.74	15.48	30.96	77.39	154.78	309.55	773.89	
2.05	1.46	2.91	7.28	14.55	29.10	72.75	145.51	291.02	727.54	
2.10	1.37	2.75	6.86	13.73	27.46	68.64	137.29	274.58	686.44	
2.15	1.30	2.60	6.50	12.99	25.99	64.97	129.95	259.89	649.73	
2.20	1.23	2.47	6.17	12.34	24.67	61.68	123.35	246.70	616.75	
2.25	1.17	2.35	5.87	11.74	23.48	58.70	117.39	234.78	586.96	
2.30	1.12	2.24	5.60	11.20	22.40	55.99	111.98	223.96	559.91	
2.35	1.07	2.14	5.35	10.70	21.41	53.52	107.05	214.10	535.24	
2.40	1.03	2.05	5.13	10.25	20.51	51.27	102.53	205.06	512.66	
2.45	0.98	1.97	4.92	9.84	19.68	49.19	98.38	196.76	491.90	
2.50	0.95	1.89	4.73	9.46	18.91	47.28	94.55	189.11	472.76	
2.55	0.91	1.82	4.55	9.10	18.20	45.51	91.01	182.02	455.06	
2.60	0.88	1.75	4.39	8.77	17.55	43.86	87.73	175.45	438.63	877.26
2.65	0.85	1.69	4.23	8.47	16.93	42.33	84.67	169.34	423.34	846.69
2.70	0.82	1.64	4.09	8.18	16.36	40.91	81.82	163.64	409.09	818.18
2.75	0.79	1.58	3.96	7.92	15.83	39.58	79.15	158.31	395.77	791.53
2.80	0.77	1.53	3.83	7.67	15.33	38.33	76.66	153.31	383.28	766.56
2.85	0.74	1.49	3.72	7.43	14.86	37.16	74.13	148.62	371.56	743.12
2.90	0.72	1.44	3.61	7.21	14.42	36.05	72.11	144.21	360.53	721.07
2.95	0.70	1.40	3.50	7.00	14.01	35.01	70.03	140.06	350.14	700.29
3.00	0.68	1.36	3.40	6.81	13.61	34.03	68.07	136.13	340.34	680.67
3.05	0.66	1.32	3.31	6.62	13.24	33.11	66.21	132.43	331.06	662.13
3.10	0.64	1.29	3.22	6.45	12.89	32.23	64.46	128.91	322.28	644.56
3.15	0.63	1.26	3.14	6.28	12.56	31.40	62.79	125.58	313.95	627.91
3.20	0.61	1.22	3.06	6.12	12.24	30.60	61.21	122.42	306.05	612.09
3.25	0.60	1.19	2.99	5.97	11.94	29.85	59.71	119.41	298.53	597.05
3.30	0.58	1.17	2.91	5.83	11.65	11.65	58.27	116.55	291.37	582.73



Elektronische Bauelemente

ST2123

CMOS Positive
Voltage Regulator

External Resistor Divider Table

R1(K Ohm)	1	2	5	10	20	50	100	200	500	1000
Vout	$R2(K\ Ohm)=(1.215*R1(K\ Ohm))/(VOUT-1.215)$									
3.35	0.57	1.14	2.85	5.69	11.38	28.45	56.91	113.82	284.54	569.09
3.40	0.56	1.11	2.78	5.56	11.12	27.80	55.61	111.21	278.03	556.06
3.45	0.54	1.09	2.72	5.44	10.87	27.18	54.36	108.72	271.81	543.62
3.50	0.53	1.06	2.66	5.32	10.63	26.59	53.17	106.35	265.86	531.73
3.55	0.52	1.04	2.60	5.20	10.41	26.02	52.03	104.07	260.17	520.34
3.60	0.51	1.02	2.55	5.09	10.19	25.47	50.94	101.89	254.72	509.43
3.65	0.50	1.00	2.49	4.99	9.98	24.95	49.90	99.79	249.49	498.97
3.70	0.49	0.98	2.44	4.89	9.78	24.45	48.89	97.79	244.47	488.93
3.75	0.48	0.96	2.40	4.79	9.59	23.96	47.93	95.86	239.64	479.29
3.80	0.47	0.94	2.35	4.70	9.40	23.50	47.00	94.00	235.01	470.02
3.85	0.46	0.92	2.31	4.61	9.22	23.06	46.11	92.22	230.55	461.10
3.90	0.45	0.91	2.26	4.53	9.05	22.63	45.25	90.50	226.26	452.51
3.95	0.44	0.89	2.22	4.44	8.88	22.21	44.42	88.85	222.12	444.24
4.00	0.44	0.87	2.18	4.36	8.73	21.81	43.63	87.25	218.13	436.27
4.05	0.43	0.86	2.14	4.29	8.57	21.43	42.86	85.71	214.29	428.57
4.10	0.42	0.84	2.11	4.21	8.42	21.06	42.11	84.23	210.57	421.14
4.15	0.41	0.83	2.07	4.14	8.28	20.70	41.40	82.79	206.98	413.97
4.20	0.41	0.81	2.04	4.07	8.14	20.35	40.70	81.41	203.52	407.04
4.25	0.40	0.80	2.00	4.00	8.01	20.02	40.03	80.07	200.16	400.33
4.30	0.39	0.79	1.97	3.94	7.88	19.69	39.38	78.77	196.92	393.84
4.35	0.39	0.78	1.97	3.88	7.75	19.38	38.76	77.51	193.78	387.56
4.40	0.38	0.76	1.91	3.81	7.63	19.07	38.15	76.30	190.74	381.48
4.45	0.38	0.75	1.88	3.76	7.51	18.78	37.56	75.12	187.79	375.58
4.50	0.37	0.74	1.85	3.70	7.40	18.49	36.99	73.97	184.93	369.86
4.55	0.36	0.73	1.82	3.64	7.29	18.22	36.43	72.86	182.16	364.32
4.60	0.36	0.72	1.79	3.59	7.18	17.95	35.89	71.79	179.47	358.94
4.65	0.35	0.71	1.77	3.54	7.07	17.69	35.37	70.74	176.86	353.71
4.70	0.35	0.70	1.74	3.49	6.97	17.43	34.86	69.73	174.32	348.64
4.75	0.34	0.69	1.72	3.44	6.87	17.19	34.37	68.74	171.85	343.71
4.80	0.34	0.68	1.69	3.39	6.78	16.95	33.89	67.78	169.46	338.91
4.85	0.33	0.67	1.67	3.34	6.69	16.71	33.43	66.85	167.13	334.25
4.90	0.33	0.66	1.65	3.30	6.59	16.49	32.97	65.94	164.86	329.72
4.95	0.33	0.65	1.63	3.25	6.51	16.27	32.53	65.06	162.65	325.30
5.00	0.32	0.64	1.61	3.21	6.42	16.05	32.10	64.02	160.50	321.00

Note: Small load (greater than 2mA) is necessary as R1 or R2 is large than 50Kohm. Otherwise, output voltage probably cannot be pulled down to 0V on disable mode