

Features

- Ultra-Low Forward Voltage Drop
- Excellent High Temperature Stability
- Patented Super Barrier Rectifier Technology
- Soft, Fast Switching Capability
- **Lead Free Finish, RoHS Compliant (Note 2)**
- **“Green” Molding Compound (No Br, Sb)**



Top View

Mechanical Data

- Case: D Pak (TO-252)
- Case Material: Molded Plastic, UL Flammability Classification Rating 94V-0
- Moisture Sensitivity: Level 1 per J-STD-020D
- Terminals: Matte Tin Finish annealed over Copper leadframe. Solderable per MIL-STD-202, Method 208 ^(E3)
- Marking Information: See Page 3
- Ordering Information: See Page 3
- Weight: 0.4 grams (approximate)

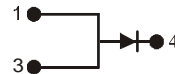

Package Pin Out Configuration

Maximum Ratings @ $T_A = 25^\circ\text{C}$ unless otherwise specified

Single phase, half wave, 60Hz, resistive or inductive load.
For capacitance load, derate current by 20%.

Characteristic	Symbol	Value	Unit
Peak Repetitive Reverse Voltage	V_{RRM}	45	V
Working Peak Reverse Voltage	V_{RWM}		
DC Blocking Voltage	V_{RM}		
RMS Reverse Voltage	$V_{R(RMS)}$	31	V
Average Rectified Output Current @ $T_C = 110^\circ\text{C}$	I_O	10	A
Non-Repetitive Peak Forward Surge Current 8.3ms Single Half Sine-Wave Superimposed on Rated Load	I_{FSM}	125	A

Thermal Characteristics @ $T_A = 25^\circ\text{C}$ unless otherwise specified

Characteristic	Symbol	Value	Unit
Typical Thermal Resistance			
Thermal Resistance Junction to Case	$R_{\theta JC}$	2.0	$^\circ\text{C/W}$
Thermal Resistance Junction to Ambient (Note 3)	$R_{\theta JA}$	34	
Operating and Storage Temperature Range	T_J, T_{STG}	-65 to +150	$^\circ\text{C}$

Electrical Characteristics @ $T_A = 25^\circ\text{C}$ unless otherwise specified

Characteristic	Symbol	Min	Typ	Max	Unit	Test Condition
Forward Voltage Drop	V_F	-	-	0.57 0.54	V	$I_F = 10\text{A}, T_J = 25^\circ\text{C}$ $I_F = 10\text{A}, T_J = 125^\circ\text{C}$
Leakage Current (Note 1)	I_R	-	-	0.5	mA	$V_R = 45\text{V}, T_J = 25^\circ\text{C}$

- Notes:
1. Short duration pulse test used to minimize self-heating effect.
 2. EU Directive 2002/95/EC (RoHS). All applicable RoHS exemptions applied, see *EU Directive 2002/95/EC Annex Notes*.
 3. Polyimide PCB 2 oz. Copper, minimum recommended pad layout as shown on Diodes Inc. suggested pad layout document AP02001, which can be found on our website at <http://www.diodes.com/datasheets/ap02001.pdf>.

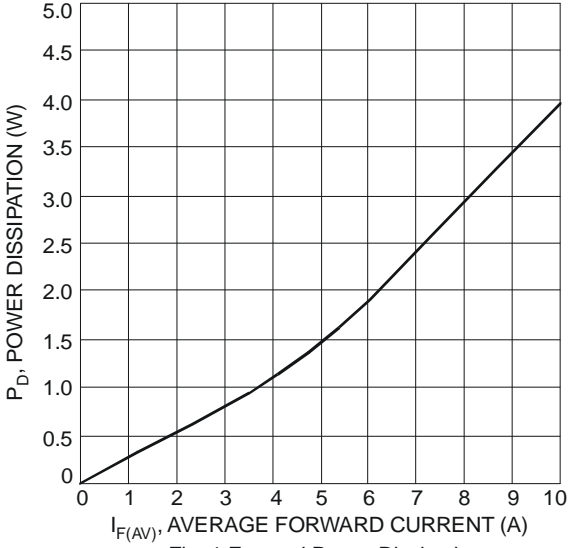

Fig. 1 Forward Power Dissipation

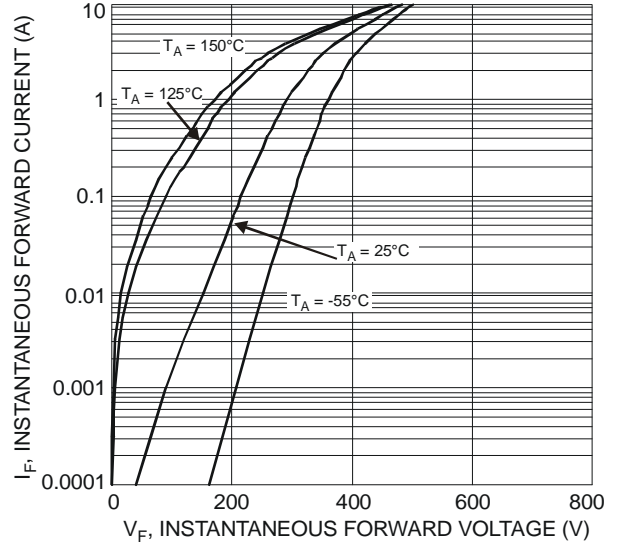

Fig. 2 Typical Forward Characteristics

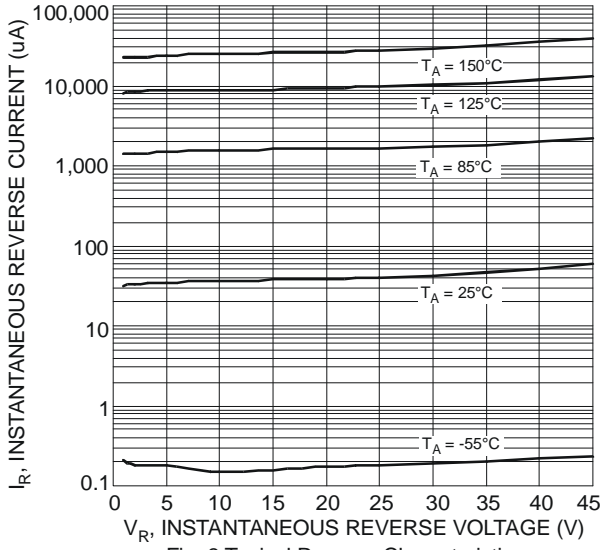

Fig. 3 Typical Reverse Characteristics

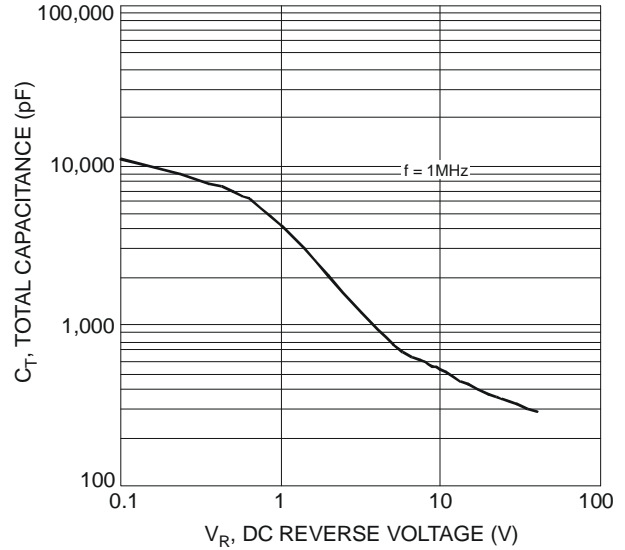

Fig. 4 Total Capacitance vs. Reverse Voltage

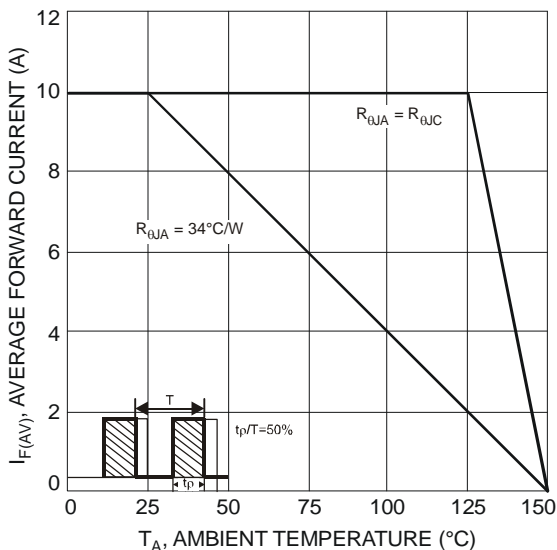

Fig. 5 Forward Current Derating Curve

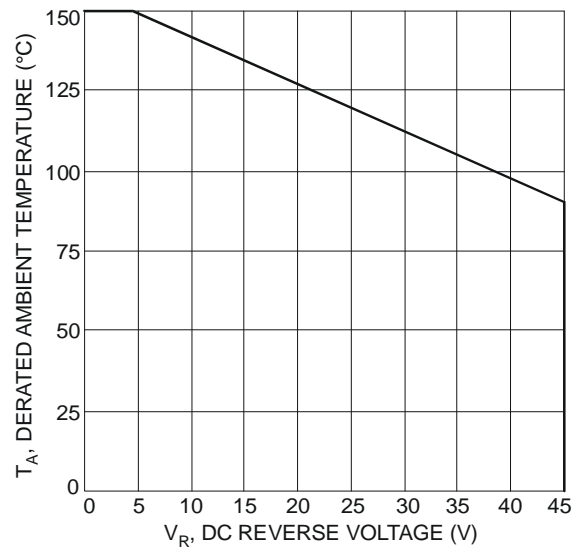
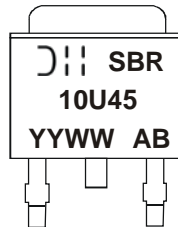

Fig. 6 Operating Temperature Derating

Ordering Information (Note 4)

Part Number	Case	Packaging
SBR10U45D1-13	D Pak (TO-252)	80 pieces/tube 2500 pieces/reel

Notes: 4. For packaging details, go to our website at <http://www.diodes.com/datasheets/ap02007.pdf>.

Marking Information

SBR10U45 = Product Type Marking Code
 AB = Foundry and Assembly Code
 YYWW = Date Code Marking
 YY = Last two digits of year, (ex: 07 = 2007)
 WW = Week (01-52)

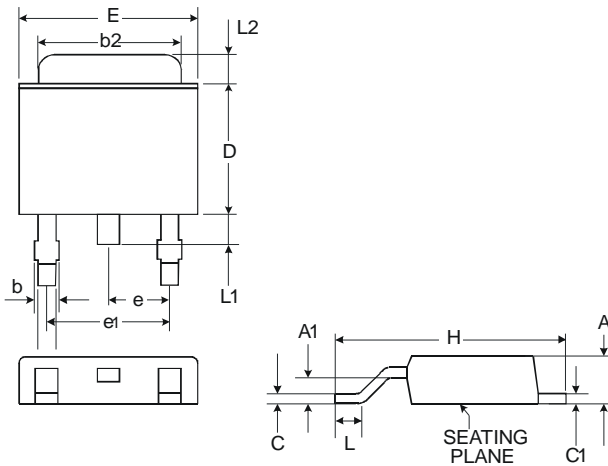
Package Outline Dimensions

DPAK		
Dim	Min	Max
A	2.18	2.40
A1	0.89	1.14
b	0.61 Typ.	
b2	5.20	5.50
C	0.45	0.58
C1	0.45	0.58
D	5.40	6.20
E	6.35	6.80
e	2.28 Typ.	
e1	4.57 Typ.	
H	9.00	10.40
L	0.51	—
L1	0.64	1.02
L2	0.88	1.27
All Dimensions in mm		

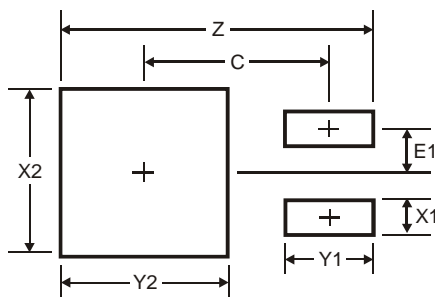
Suggested Pad Layout

Dimensions	Value (in mm)
Z	11.6
X1	1.5
X2	7.0
Y1	2.5
Y2	7.0
C	6.9
E1	2.3

IMPORTANT NOTICE

Diodes Incorporated and its subsidiaries reserve the right to make modifications, enhancements, improvements, corrections or other changes without further notice to any product herein. Diodes Incorporated does not assume any liability arising out of the application or use of any product described herein; neither does it convey any license under its patent rights, nor the rights of others. The user of products in such applications shall assume all risks of such use and will agree to hold Diodes Incorporated and all the companies whose products are represented on our website, harmless against all damages.

LIFE SUPPORT

Diodes Incorporated products are not authorized for use as critical components in life support devices or systems without the expressed written approval of the President of Diodes Incorporated.

SBR is a registered trademark of Diodes Incorporated.