

To all our customers

Regarding the change of names mentioned in the document, such as Hitachi Electric and Hitachi XX, to Renesas Technology Corp.

The semiconductor operations of Mitsubishi Electric and Hitachi were transferred to Renesas Technology Corporation on April 1st 2003. These operations include microcomputer, logic, analog and discrete devices, and memory chips other than DRAMs (flash memory, SRAMs etc.) Accordingly, although Hitachi, Hitachi, Ltd., Hitachi Semiconductors, and other Hitachi brand names are mentioned in the document, these names have in fact all been changed to Renesas Technology Corp. Thank you for your understanding. Except for our corporate trademark, logo and corporate statement, no changes whatsoever have been made to the contents of the document, and these changes do not constitute any alteration to the contents of the document itself.

Renesas Technology Home Page: <http://www.renesas.com>

Renesas Technology Corp.
Customer Support Dept.
April 1, 2003

Cautions

Keep safety first in your circuit designs!

1. Renesas Technology Corporation puts the maximum effort into making semiconductor products better and more reliable, but there is always the possibility that trouble may occur with them. Trouble with semiconductors may lead to personal injury, fire or property damage.

Remember to give due consideration to safety when making your circuit designs, with appropriate measures such as (i) placement of substitutive, auxiliary circuits, (ii) use of nonflammable material or (iii) prevention against any malfunction or mishap.

Notes regarding these materials

1. These materials are intended as a reference to assist our customers in the selection of the Renesas Technology Corporation product best suited to the customer's application; they do not convey any license under any intellectual property rights, or any other rights, belonging to Renesas Technology Corporation or a third party.
2. Renesas Technology Corporation assumes no responsibility for any damage, or infringement of any third-party's rights, originating in the use of any product data, diagrams, charts, programs, algorithms, or circuit application examples contained in these materials.
3. All information contained in these materials, including product data, diagrams, charts, programs and algorithms represents information on products at the time of publication of these materials, and are subject to change by Renesas Technology Corporation without notice due to product improvements or other reasons. It is therefore recommended that customers contact Renesas Technology Corporation or an authorized Renesas Technology Corporation product distributor for the latest product information before purchasing a product listed herein.
The information described here may contain technical inaccuracies or typographical errors. Renesas Technology Corporation assumes no responsibility for any damage, liability, or other loss rising from these inaccuracies or errors.
Please also pay attention to information published by Renesas Technology Corporation by various means, including the Renesas Technology Corporation Semiconductor home page (<http://www.renesas.com>).
4. When using any or all of the information contained in these materials, including product data, diagrams, charts, programs, and algorithms, please be sure to evaluate all information as a total system before making a final decision on the applicability of the information and products. Renesas Technology Corporation assumes no responsibility for any damage, liability or other loss resulting from the information contained herein.
5. Renesas Technology Corporation semiconductors are not designed or manufactured for use in a device or system that is used under circumstances in which human life is potentially at stake. Please contact Renesas Technology Corporation or an authorized Renesas Technology Corporation product distributor when considering the use of a product contained herein for any specific purposes, such as apparatus or systems for transportation, vehicular, medical, aerospace, nuclear, or undersea repeater use.
6. The prior written approval of Renesas Technology Corporation is necessary to reprint or reproduce in whole or in part these materials.
7. If these products or technologies are subject to the Japanese export control restrictions, they must be exported under a license from the Japanese government and cannot be imported into a country other than the approved destination.
Any diversion or reexport contrary to the export control laws and regulations of Japan and/or the country of destination is prohibited.
8. Please contact Renesas Technology Corporation for further details on these materials or the products contained therein.

HA12226F/HA12227F

Audio Signal Processor for Cassette Deck
(Dolby B-type NR with Recording System)



ADE-207-270E (Z)

6th Edition
Dec. 2000

Description

The HA12226F/HA12227F are silicon monolithic bipolar IC providing Dolby noise reduction system*¹, music sensor system, REC equalizer system and each electronic control switch in one chip.

Note: 1. Dolby is a trademark of Dolby Laboratories Licensing Corporation.

A license from Dolby Laboratories Licensing Corporation is required for the use of this IC.

The HA12227F is not built-in Dolby B-NR.

Functions

- Dolby B-NR*² × 2 channel
- REC equalizer × 2 channel
- Music sensor × 1 channel
- Pass amp. × 2 channel
- Each electronic control switch to change REC equalizer, bias, etc.

Note: 2. The HA12227F is not built-in Dolby B-NR.

Features

- REC equalizer is very small number of external parts and have 4 types of frequency characteristics built-in.
- 2 types of input for PB, 1 type of input for REC.
- 70μ - PB equalizer changing system built-in.
- Dolby NR*² with dubbing double cassette decks.
Unprocessed signal output available from recording out terminals during PB mode.
- Provide stable music sensor system, available to design music sensing time and level.
- Controllable from direct micro-computer output.
- Bias oscillator control switch built-in.
- NR ON / OFF and REC / PB fully electronic control switching built-in.
- Normal-speed / high-speed, Normal / Crom and PB equalizer fully electronic control switching built-in.
- Available to reduce substrate-area because of high integration and small external parts.

HA12226F/HA12227F

Ordering Information

Operating Voltage

Product	Power Supply Range (Single Supply)
HA12226F	11.0 V to 15.0 V
HA12227F	9.5 V to 15.0 V

Standard Level

Product	Package	PB-OUT Level	REC-OUT Level	Dolby Level
HA12226F	FP-56A	580 mVrms	300 mVrms	300 mVrms
HA12227F				—

Function

Product	Dolby B-NR	REC-EQ	Music Sensor	Pass Amp.	REC / PB Selection	ALC
HA12226F	○	○	○	○	○	○
HA12227F	×	○	○	○	○	○

Note: Depending on the employed REC / PB head and test tape characteristics, there is a rare case that the REC-EQ characteristics of this LSI can not be matched to the required characteristics because of built-in resistors which determined the REC-EQ parameters in this case, please inquire the responsible agent because the adjustment built-in resistor is necessary.

Difference of HA12215F and HA12226F/HA12227F

Product	Supply Voltage	Tape Correspondence		
		NORM	CROM	METAL
HA12226F/HA12227F	Single supply voltage	○	○	×
HA12215F	Split supply voltage	○	○	○

Note: The HA12226F/HA12227F became single power supply for the HA12215F and deleted metal correspondence. The HA12227F is not built-in Dolby B-NR. Other characteristic aspects are similar as the HA12215F.

Pin Description, Equivalent Circuit ($V_{CC} = 12\text{ V}$, A system of single supply voltage, $T_a = 25^\circ\text{C}$, No Signal, The value in the show typical value.)

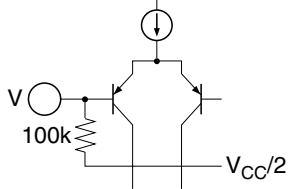
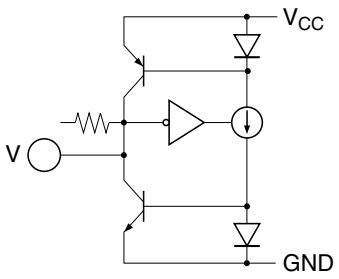
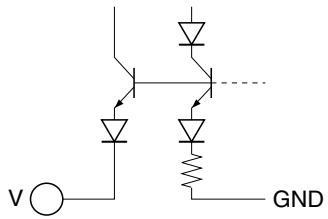
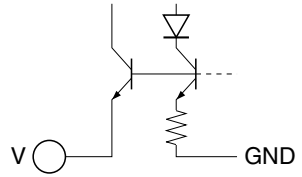
Pin No.	Terminal Name	Note	Equivalent Circuit	Pin Description
51	AIN (R)	$V = V_{CC} / 2$		PB A Deck input
48	AIN (L)			
53	BIN (R)			PB B Deck input
46	BIN (L)			
56	RIN (R)			REC input
43	RIN (L)			
5	EQIN (R)			REC equalizer input
38	EQIN (L)			
1 * ²	DET (R)	$V = 2.7\text{ V}$		Time constant pin for Dolby-NR
42 * ²	DET (L)			
49	RIP			Ripple filter
2 * ³	BIAS1	$V = 0.6\text{ V}$		Dolby bias current input
41	BIAS2	$V = 1.3\text{ V}$		REC equalizer bias current input

HA12226F/HA12227F

Pin Description, Equivalent Circuit ($V_{CC} = 12\text{ V}$, A system of single supply voltage, $T_a = 25^\circ\text{C}$, No Signal, The value in the show typical value.) (cont)

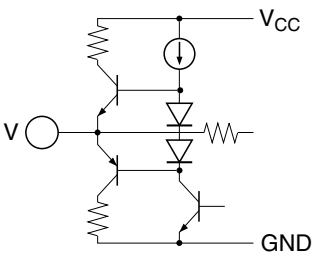
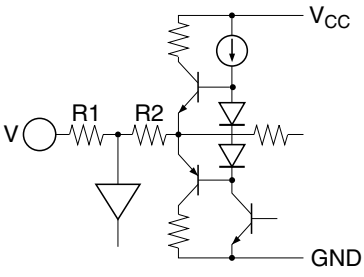
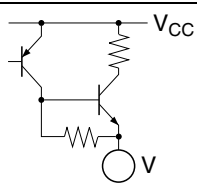
Pin No.	Terminal Name	Note	Equivalent Circuit	Pin Description
3	PBOUT (R)	$V = V_{CC} / 2$		PB output
40	PBOUT (L)			
4	RECOUT (R)			REC output
39	RECOUT (L)			
7	EQOUT (R)			REC equalizer output
36	EQOUT (L)			
28	MAOUT			MS Amp. output *1
8	ROUT (R)			Input Amp. output
35	ROUT (L)			
52	ABO (R)	$R1 = 15\text{ k}$ $R2 = 12\text{ k}$ $V = V_{CC} / 2$		Time constant pin for PB equalizer (70μ)
47	ABO (L)			
6	BOOST (R)	$R1 = 4.8\text{ k}$ $R2 = 4.8\text{ k}$ $V = V_{CC} / 2$		Time constant pin for low boost
37	BOOST (L)			
32	BIAS (C)	$V = V_{CC} - 0.7\text{ V}$		REC bias current output
33	BIAS (N)			

HA12226F/HA12227F

Pin Description, Equivalent Circuit ($V_{CC} = 12\text{ V}$, A system of single supply voltage, $T_a = 25^\circ\text{C}$, No Signal, The value in the show typical value.) (cont)

Pin No.	Terminal Name	Note	Equivalent Circuit	Pin Description
10	GPCAL	$R = 110\text{ k}\Omega$		GP gain calibration terminal
11	RECCAL	$R = 110\text{ k}\Omega$		REC gain calibration terminal
12	ALCCAL	$R = 140\text{ k}\Omega$		ALC operation level calibration terminal
14	MSDET	$n = 6$		Time constant pin for MS ^{*1}
13	ALCDET	$n = 2$		
27	MSIN	$R = 50\text{ k}\Omega$		MS input ^{*1}
9	ALCIN (R)	$R = 100\text{ k}\Omega$		
34	ALCIN (L)			
30	MAI	$V = V_{CC} / 2$		MS Amp. input ^{*1}
29	MS GND	$V = 0\text{ V}$		MS output voltage level control pin ^{*1}
55	ALC (R)	$V = 0\text{ V}$		Variable impedance for attenuation
44	ALC (L)			

- Note:
1. MS: Music Sensor
 2. Non connection regarding the HA12227F.
 3. Test pin regarding the HA12227F.

Block Diagram

HA12226F

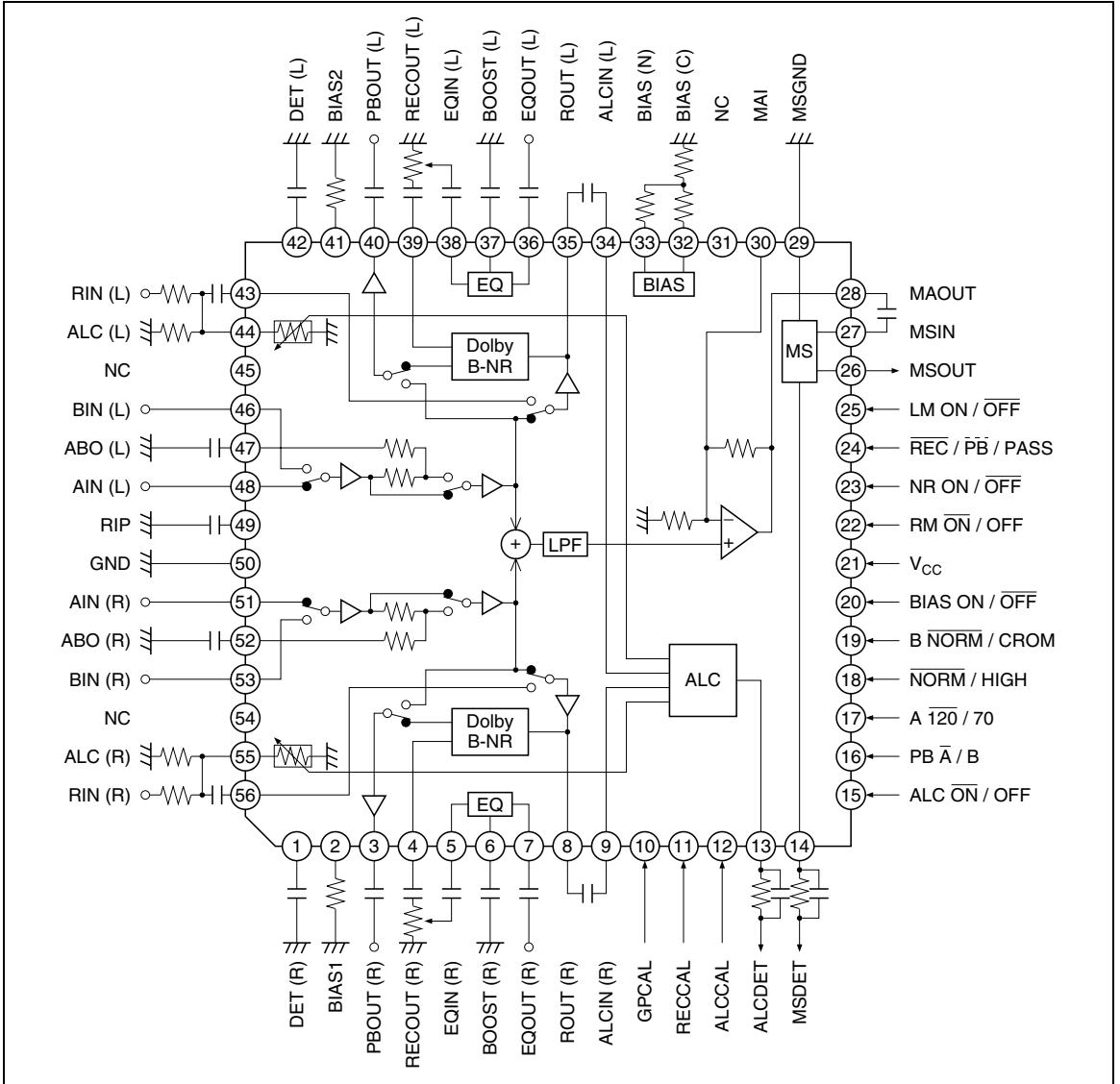

HA12226F/HA12227F

HA12227F

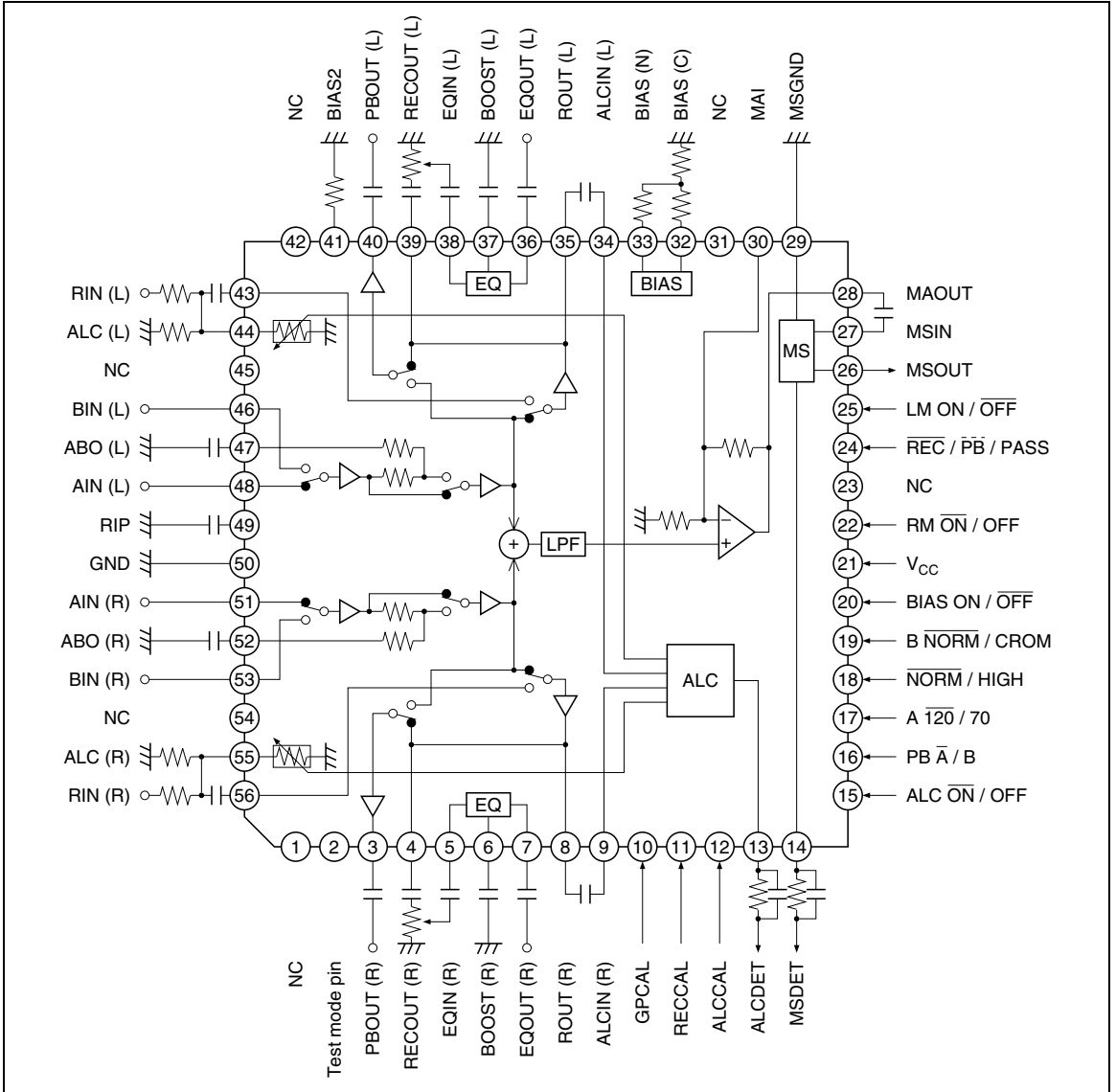

Parallel-Data Format

Pin No.	Pin Name	Lo	Mid	Hi	MODE "Pin Open"
15	ALC $\overline{\text{ON}}$ /OFF	ALC ON	—	ALC OFF	Lo
16	PB $\overline{\text{A}}$ /B	Ain * ¹	—	Bin * ¹	Lo
17	A $\overline{\text{120/70}}$	*1	—	*1	Lo
22	RM $\overline{\text{ON}}$ /OFF	REC MUTE ON	—	REC MUTE OFF	Lo
20	BIAS ON/ $\overline{\text{OFF}}$	BIAS OFF	—	BIAS ON	Lo
23 * ²	NR ON/ $\overline{\text{OFF}}$	NR OFF	—	NR ON	Lo
24	$\overline{\text{REC}}$ /PB/PASS	REC MODE	PB MODE	REC MODE PASS	Mid
25	LM ON/ $\overline{\text{OFF}}$	LINE MUTE OFF	—	LINE MUTE ON	Lo
18	$\overline{\text{NORM}}$ /HIGH	Normal speed	—	High speed	Lo
19	B $\overline{\text{NORM}}$ /CROM	REC EQ Normal * ¹ Bias Normal	REC EQ CROM * ¹ Bias CROM	REC EQ CROM * ¹ Bias CROM	Lo

Note: 1. PB EQ logic

A $\overline{\text{120/70}}$	B $\overline{\text{NORM}}$ / CROM	PB	
		Lo	Hi
Lo	Lo	FLAT	FLAT
Lo	Mid or Hi	FLAT	70 μ
Hi	Lo	70 μ	FLAT
Hi	Mid or Hi	70 μ	70 μ

2. The HA12226F only.

Functional Description

Power Supply Range

These ICs are designed to operate on single supply.

Table 1 Supply Voltage

Product	Power Supply Range (Single Supply)
HA12226F	11.0 V to 15.0 V
HA12227F	9.5 V to 15.0 V

Note: The lower limit of supply voltage depends on the line output reference level.
The minimum value of the overload margin is specified as 12 dB by Dolby Laboratories (Dolby IC HA12226F).

Reference Voltage

The reference voltage are provided for the left channel and the right channel separately. The block diagram is shown as figure 1.

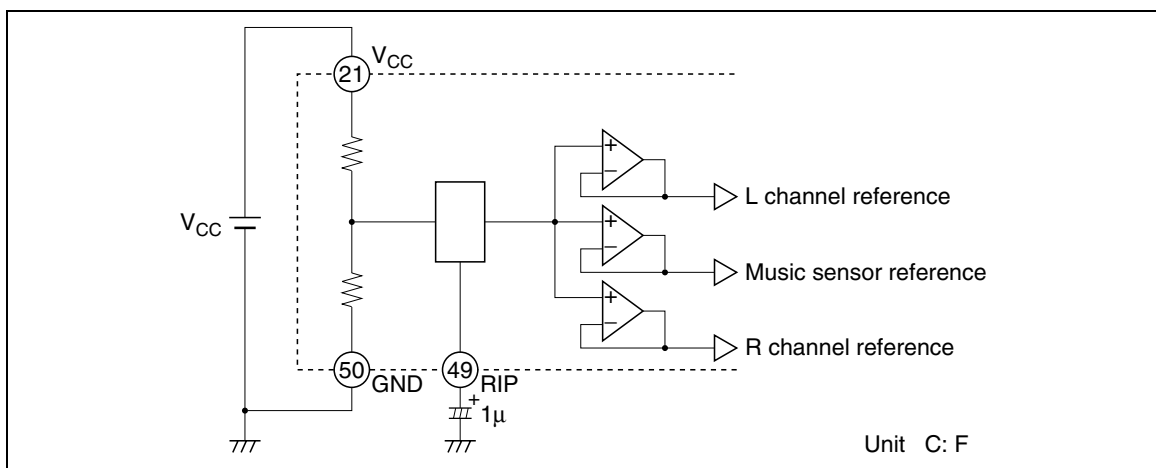
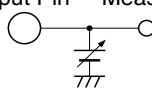

Figure 1 Reference Voltage

Operating Mode Control

The HA12226F/HA12227F provide fully electronic switching circuits. And each operating mode control is controlled by parallel data (DC voltage).

Table 2 Control Voltage

Pin No.	Lo	Mid	Hi	Unit	Test Condition
15, 16, 17, 18, 20, 22, 23*4, 25	-0.2 to 1.0	—	4.0 to V_{CC}	V	Input Pin Measure 
19, 24	-0.2 to 1.0	2.0 to 3.0	4.0 to V_{CC}	V	

- Notes:
1. Each pins are on pulled down with 100 kΩ internal resistor. Therefore, it will be low-level when each pins are open. But pin 24 is mid-level when it is open.
 2. Over shoot level and under shoot level of input signal must be the standardized (High: V_{CC} , Low: -0.2 V).
 3. For reduction of pop noise, connect 1 μF to 22 μF capacitor with mode control pins. But it is impossible to reduce completely in regard to Line mute, therefore, use external mute at the same time.
 4. Non connection regarding the HA12227F.

Input Block Diagram and Level Diagram

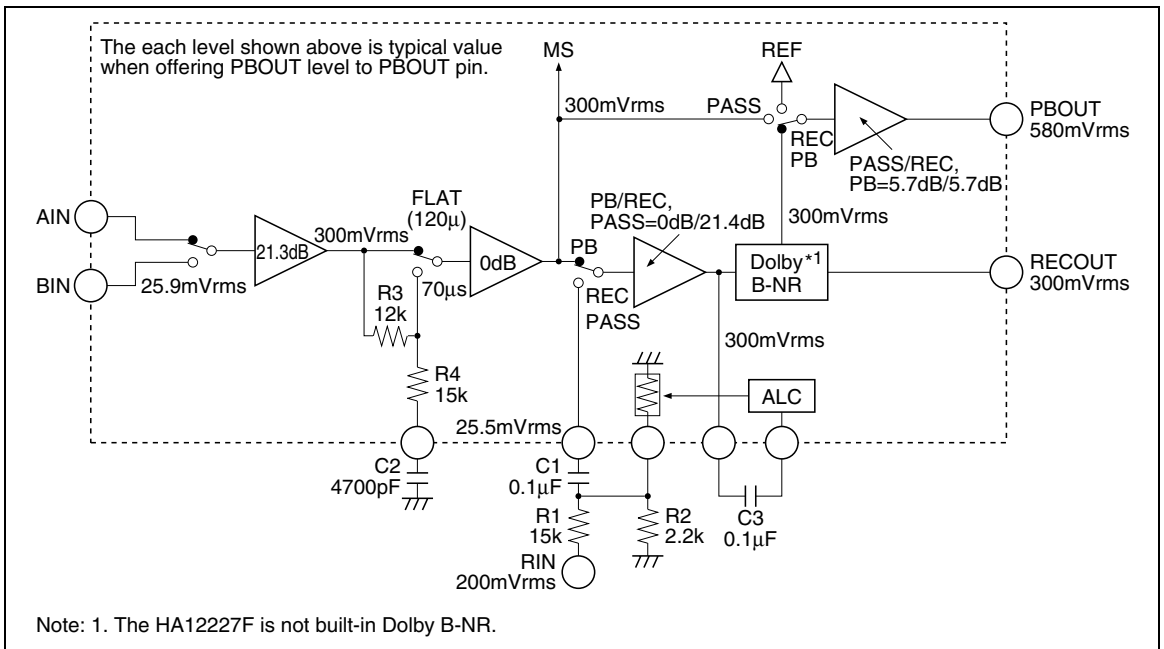

Figure 2 Input Block Diagram

PB Equalizer

By switching logical input level of pin 17 (for Ain) and pin 19 (for Bin), you can equalize corresponding to tape position at play back mode.

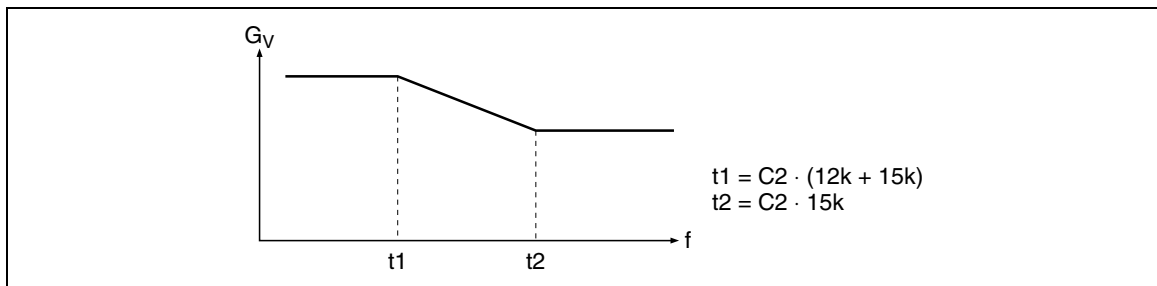

Figure 3 Frequency Characteristic of PB Equalizer

The Sensitivity Adjustment of Music Sensor

Adjusting MS Amp gain by external resistor, the sensitivity of music sensor can set up.

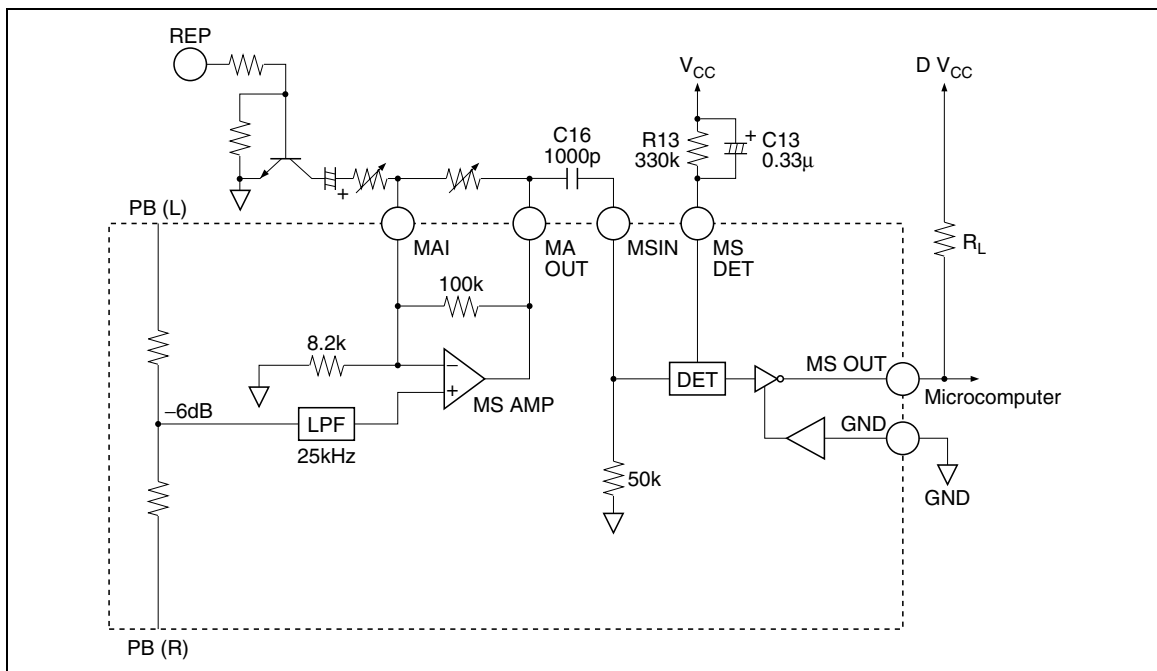

Figure 4 Music Sensor Block Diagram

The Sensitivity of Music Sensor

A standard level of MS input pin 25.9 mVrms, therefore, the sensitivity of music sensor (S) can request it, by lower formulas.

$$A = \text{MS Amp Gain} \times 1$$

$$B = \text{PB input Gain} \times (1/2)^2 \quad S = 20 \log \frac{C}{25.9 \cdot A \cdot B} \text{ [dB]}$$

$$C = \text{Sensed voltage}$$

$$20 \log (A \times B) = D \text{ [dB]} \quad S = 14 - D \text{ [dB]}$$

$$C = 130 \text{ [mVrms]} \text{ (Intenally voltage in a standard)}$$

$$\text{PB input Gain} = 21.3 \text{ [dB]}$$

- Notes: 1. When there is not a regulation outside.
 2. Case of one-sided channel input.

But necessary to consider the same attenuation quantity practically, on account of A(B) have made frequency response.

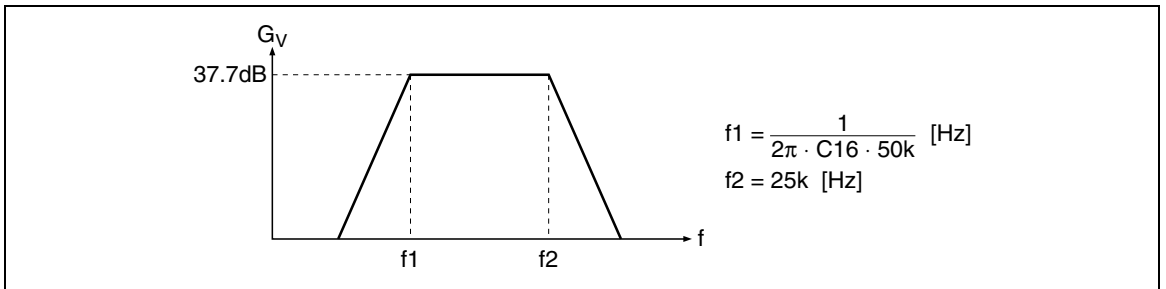

Figure 5 Frequency Characteristic of MSIN

Occasion of the external component of figure 4, f1 is 3.18 kHz.

Time constant of detection

Figure 6(1) generally shows that detection time is in proportion to value of capacitor C13. But, with Attack*² and Recovery*³ the detection time differs exceptionally.

- Notes 2. Attack : Non-music to Music
 3. Recovery : Music to Non-music

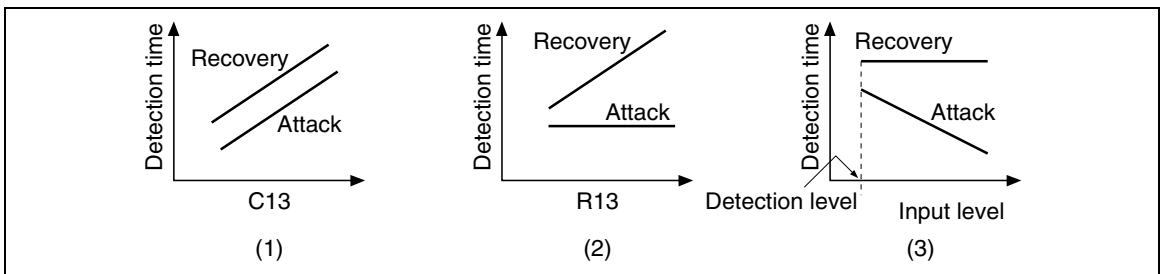

Figure 6 Function Characteristic of MS

Like the figure 6(2), Recovery time is variably possible by value of resistor R13. But Attack time gets about fixed value. Attack time has dependence by input level. When a large signal is inputted, Attack time is short tendency.

Music Sensor Output (MSOUT)

As for internal circuit of music sensor block, music sensor output pin is connected to the collector of NPN type directly, output level will be “high” when sensing no signal. And output level will be “low” when sensing signal.

Connection with microcomputer, it is requested to use external pull up resistor ($R_L = 10\text{ k}\Omega$ to $22\text{ k}\Omega$)

Note: Supply voltage of MSOUT pin must be less than V_{CC} voltage.

The Tolerances of External Components for Dolby NR-Block (Only the HA12226F)

For Dolby NR precision securing, please use external components shown at figure 7. If leak-current are a few electrolytic-capacitor, it can be applicable to C5 and C23.

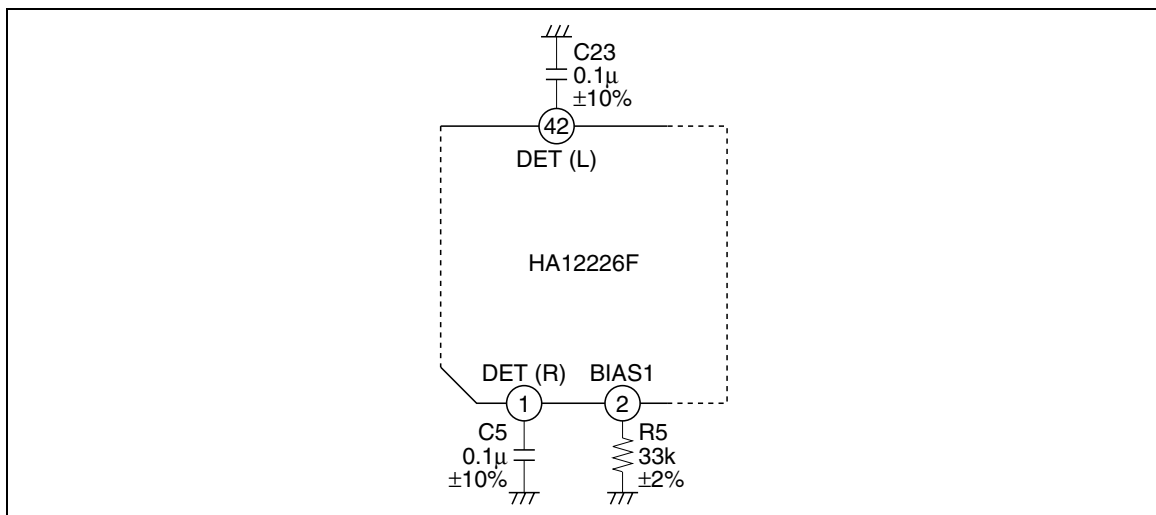

Figure 7 Tolerance of External Components

Low-Boost

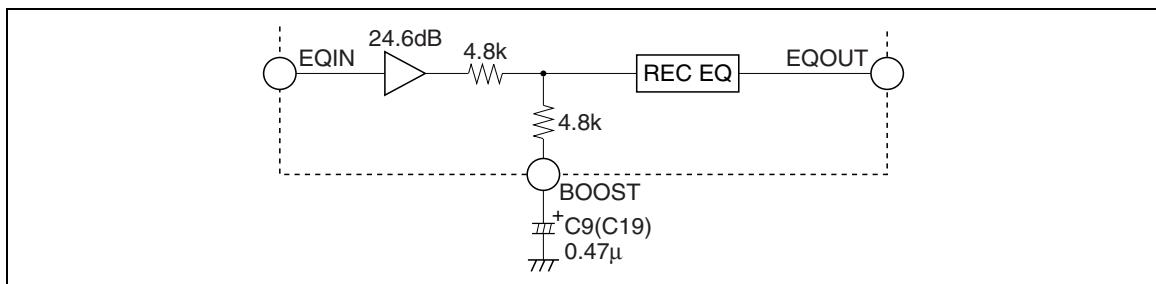

Figure 8 Example of Low Boost Circuit

External components shown figure 8 gives frequency response to take 6 dB boost. And cut off frequency can request it, by C9 (C19).

REC Equalizer

The outlines of REC Equalizing frequency characteristics are shown by figure 9. Those peak level can be set up by supplying voltage. (0 V to 5 V, GND = 0 V) to pin 10 (GPCAL).

And whole band gain can be set up by supplying voltage (0 V to 5 V, GND = 0 V) to pin 11 (RECCAL).

Both setting up range are ±4.5 dB. In case that you do not need setting up, pin 10, pin 11 should be open bias.

Note: Depending on the employed REC/PB head and test tape characteristics, there is a rare case that the REC-EQ characteristics of this LSI can not be matched to the required characteristics because of built-in resistors which determined the REC-EQ parameters in this case, please inquire the responsible agent because of the adjustment of built-in resistor is necessary.

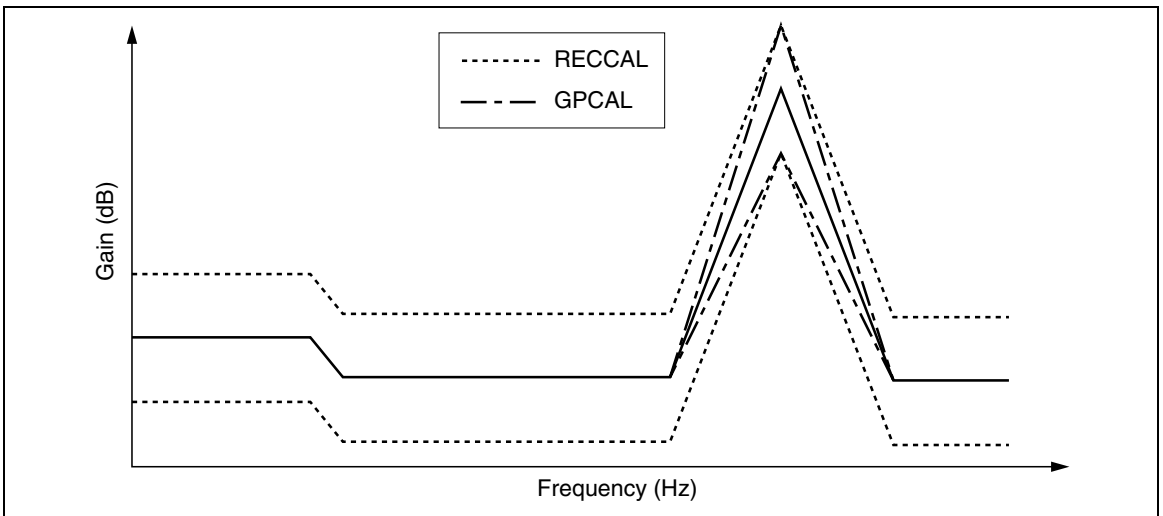

Figure 9 Frequency Characteristics of REC Equalizer

Bias Switch

The HA12215F built-in DC voltage generator for bias oscillator and its bias switches.

External resistor R20, R21 which corresponded with tape positions and bias out voltage are related with below.

$$V_{bias} \doteq \left(\frac{R22}{(R20 \text{ or } R21) + R22} \right) \times (V_{CC} - 0.7) \text{ [V]}$$

Bias switch follows to a logic of pin 19 (B / Norm / Crom).

Note: A current that flows at bias out pin, please use it less than 5 mA.

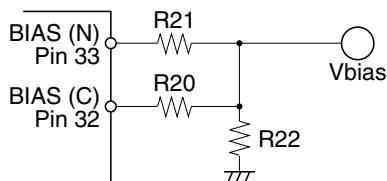

Figure 10 External Components of Bias Block

Automatic Level Control

ALC is the input decay rate variable system. It has internal variable resistors of pin 55 (pin 44) by RECOUT signal that is inputted to pin 9 (pin 34).

The operation is similitude to MS, detected by pin 13.

The signal input pin is pin 56 (pin 43). Resistor R1, R2 and capacitor C2, external components, for the input circuit are commended as figure 12. There are requested to use value of the block diagram figure for performance maintenance of S/N, T.H.D. etc.

Figure 11 shows the relation with R1 front RIN point and ROUT.

ALC operation level acts for the center of +4.5 dB at tape position TYPE I and the center of +2.5 dB at tape position TYPE II, to standard level (300 mVrms).

Then, adopted maximum value circuit, ALC is operated by a large channel of a signal.

ALC ON/OFF can switch it by pin 15. Please do ALC ON, after it does for one time ALC OFF inevitably, for ALC time to start usefully (when switching PB → PASS, when switching PB → PASS), in order to reset ALC circuit.

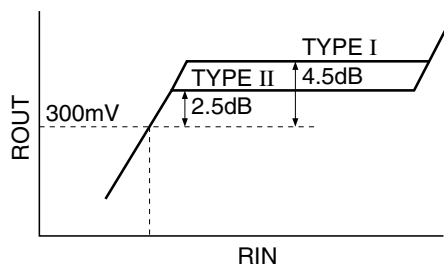

Figure 11 ALC Operation Level

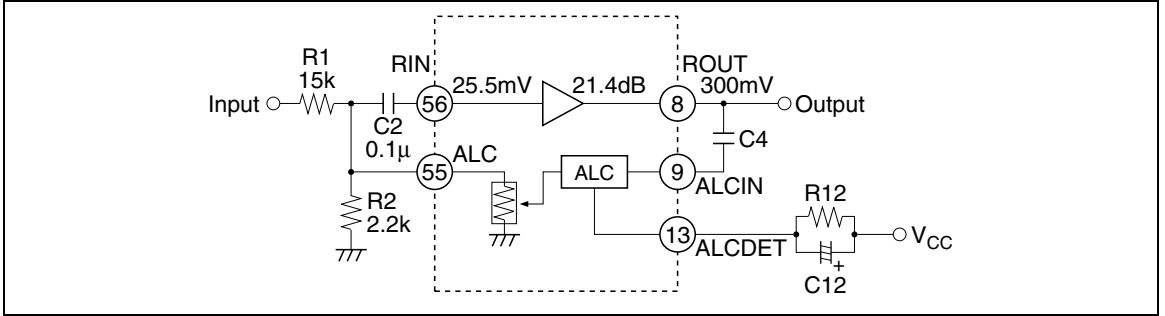

Figure 12 ALC Block Diagram

ALC Operation Level Necessary

ALC operation level is variable to pin 12 bias (ALC-CAL: 0 to 5 V), and its range is ± 4.0 dB.

Unnecessary, pin 12 is unforced.

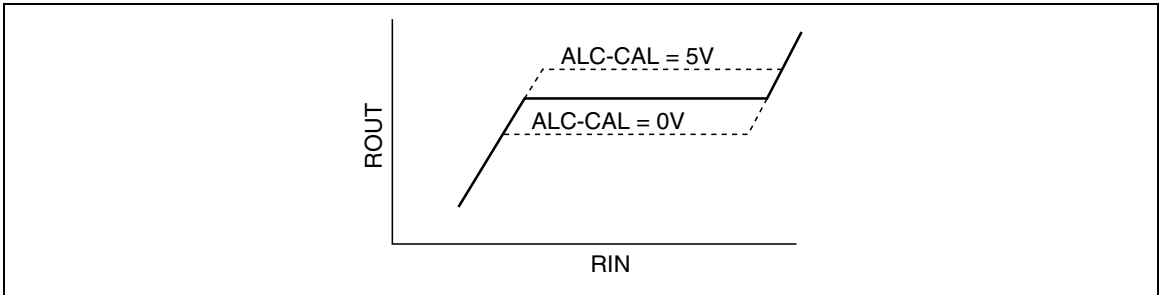

Figure 13 ALC-CAL Characteristics

About a Test Pin (Pin 2)

The HA12227F does for testing exclusive terminal for pin 2.

In mount circuit, this terminal is open or connected to GND with a resistor of 33 k Ω .

HA12226F/HA12227F

Absolute Maximum Ratings

Item	Symbol	Rating	Unit	Note
Max supply voltage	V_{cc} max	16	V	
Power dissipation	Pd	625	mW	$T_a \leq 75^\circ\text{C}$
Operating temperature	Topr	-40 to +75	$^\circ\text{C}$	
Storage temperature	Tstg	-55 to +125	$^\circ\text{C}$	

Electrical Characteristics

HA12226F

(Ta = 25°C, Vcc = 12 V, Dolby Level = REC-OUT Level = 300 mVrms = 0 dB)

Item	Symbol	Test Condition										Application Terminal									
		IC Condition *1										Input			Output						
		NR ON/OFF	ALC ON/OFF	REC/PB /PASS	A/B	120V/ 70μ	LINE MUTE	B N/C	fin (Hz)	RECOUT level (dB)	Other	Min	Typ	Max	Unit	R	L	R	L	COM	Remark
		OFF	OFF	PB	A	120	OFF	NORM	1k	0	No signal	18.0	26.0	35.0	mA	—	—	—	—	21	
Quiescent current	I _Q	OFF	OFF	PB	A	120	OFF	NORM	1k	0	25.5	27.0	28.5	dB	51/53	48/46	3	40	—		
Input AMP. gain	G _v PB	OFF	OFF	PB	A/B	120	OFF	NORM	1k	0	25.0	26.5	28.0	dB	56	43	3	40	—		
	G _v REC	OFF	OFF	REC	A	120	OFF	NORM	1k	0	2.8	4.3	5.8	dB	56	43	4	39	—		
B-type Encode boost	ENC 2k (1)	ON	OFF	REC	A	120	OFF	NORM	2k	-20	7.0	8.5	10.0	dB	56	43	4	39	—		
	ENC 2k (2)	ON	OFF	REC	A	120	OFF	NORM	2k	-30	1.7	3.2	4.7	dB	56	43	4	39	—		
	ENC 5k (1)	ON	OFF	REC	A	120	OFF	NORM	5k	-20	6.7	8.2	9.7	dB	56	43	4	39	—		
	ENC 5k (2)	ON	OFF	REC	A	120	OFF	NORM	5k	-30	12.0	13.0	—	dB	56	43	4	39	—	2	
Signal handling	Vo max	ON	OFF	REC	A	120	OFF	NORM	1k	—	THD=1%	—	—	—	—	—	—	—	—	—	
	S/N	ON	OFF	REC	A	120	OFF	NORM	1k	—	Rg=5.1kΩ, CCIR/ARM	—	—	—	—	—	—	—	—	—	
Total Harmonic Distortion	THD	ON	OFF	REC	A	120	OFF	NORM	1k	0	—	0.05	0.3	%	56	43	4	39	—		
Channel separation	CTRL (1)	OFF	OFF	PB	A	120	OFF	NORM	1k	+12	70.0	80.0	—	dB	51	48	3	40	—		
	CTRL (2)	OFF	OFF	REC	A	120	OFF	NORM	1k	+12	70.0	85.0	—	dB	56	43	3	40	—		
Crosstalk	CT A/B	OFF	OFF	PB	A/B	120	OFF	NORM	1k	+12	70.0	80.0	—	dB	51/53	48/46	3	40	—		
	CT R/P	OFF	OFF	REC/PB	A	120	OFF	NORM	1k	+12	70.0	80.0	—	dB	51/56	48/43	3	40	—		
Pass AMP. gain	G _v PA	OFF	OFF	PASS	A/B	120	OFF	NORM	1k	0	25.5	27.0	28.5	dB	51/53	48/46	3	40	—		
Gain deviation	ΔG _v	OFF	OFF	PASS	A/B	120	OFF	NORM	1k	0	G _v PA - G _v PB	-1.0	0.0	1.0	dB	51/53	48/46	3	40	—	
MUTE ATT.	MUTE	OFF	OFF	PB	A	120	ON	NORM	1k	+12	70.0	80.0	—	dB	51	48	3	40	—		
70μ EQ gain	G _v EQ 1k	OFF	OFF	PB	A	70	OFF	GROM	1k	0	24.0	25.5	27.0	dB	51	48	3	40	—		
	G _v EQ 10k	OFF	OFF	PB	A	70	OFF	GROM	10k	0	20.8	22.3	23.8	dB	51	48	3	40	—		
MS sensing level	V _{ON}	OFF	OFF	PB	A	120	OFF	NORM	5k	—	-26.0	-22.0	-18.0	dB	51	48	3	40	26	3	
MS output low level	V _{OL}	OFF	OFF	PB	A	120	OFF	NORM	—	—	—	1.0	1.5	V	51	48	—	—	26		
MS output leak current	I _{OH}	OFF	OFF	PB	A	120	OFF	NORM	—	—	—	—	—	μA	—	—	—	—	26		
ALC operate level	ALC (1)	OFF	ON	REC	A	120	OFF	NORM	1k	+12	2.0	4.5	7.0	dB	56	43	4	39	—		
	ALC (2)	OFF	ON	REC	A	120	OFF	CROM	1k	+12	0.0	2.5	5.0	dB	56	43	4	39	—		

Notes: 1. Other IC-condition : REC-MUTE OFF, Normal tape, Normal speed, Bias OFF

2. V_{CC} = 11.0 V

3. For inputting signal to one side channel

HA12226F/HA12227F

HA12226F (cont)

(Ta = 25°C, Vcc = 12 V)

Item	Symbol	TAPE	SPEED	Test Condition		Min	Typ	Max	Unit	Application Terminal					
										Input			Output		
										R	L	R	L	R	L
Equalizer S/N	S/N (EQ)	NORM	NORM	Rg = 5.1kΩ, A-WTG Filter (0dB = -5dB at EQOUT)	SW22 (L), SW23 (R) OFF	55	58	—	dB	5	38	7	36	—	
Equalizer maximum input	Vin max (EQ)	NORM	NORM	f = 1kHz, THD = 1%, Vin = -26dB	SW22 (L), SW23 (R) OFF	10.5	12.5	—	dB	5	38	7	36	—	
Equalizer total harmonic distortion	T.H.D.1 (EQ) T.H.D.2 (EQ)	NORM	NORM	f = 1kHz, Vin = -26dB	SW22 (L), SW23 (R) OFF	—	0.2	0.5	%	5	38	7	36	—	
Equalizer offset voltage	Vofs (EQ)	NORM	NORM	No-Signal	SW22 (L), SW23 (R) OFF	-500	0	500	mV	5	38	7	36	—	
Equalizer frequency response (NORM - NORM)	GVEQ-NN1	NORM	NORM	f = 3kHz, Vin = -46dB	SW22 (L), SW23 (R) OFF	18.8	20.3	21.8	dB	5	38	7	36	—	
	GVEQ-NN2			f = 8kHz, Vin = -46dB	SW22 (L), SW23 (R) OFF	23.9	25.9	27.9	dB	5	38	7	36	—	
	GVEQ-NN3			f = 12kHz, Vin = -46dB	SW22 (L), SW23 (R) OFF	30.1	32.6	35.1	dB	5	38	7	36	—	
Equalizer frequency response (CROM - NORM)	GVEQ-CN1	CROM	NORM	f = 3kHz, Vin = -46dB	SW22 (L), SW23 (R) OFF	23.3	24.8	26.3	dB	5	38	7	36	—	
	GVEQ-CN2			f = 8kHz, Vin = -46dB	SW22 (L), SW23 (R) OFF	28.5	30.5	32.5	dB	5	38	7	36	—	
	GVEQ-CN3			f = 12kHz, Vin = -46dB	SW22 (L), SW23 (R) OFF	34.0	36.5	39.0	dB	5	38	7	36	—	
Equalizer frequency response (NORM - High)	GVEQ-NH1	NORM	HIGH	f = 5kHz, Vin = -46dB	SW22 (L), SW23 (R) OFF	15.0	16.5	18.0	dB	5	38	7	36	—	
	GVEQ-NH2			f = 15kHz, Vin = -46dB	SW22 (L), SW23 (R) OFF	19.9	21.9	23.9	dB	5	38	7	36	—	
	GVEQ-NH3			f = 20kHz, Vin = -46dB	SW22 (L), SW23 (R) OFF	23.4	25.9	28.4	dB	5	38	7	36	—	
Equalizer frequency Response (CROM - High)	GVEQ-CH1	CROM	HIGH	f = 5kHz, Vin = -46dB	SW22 (L), SW23 (R) OFF	19.7	21.2	22.7	dB	5	38	7	36	—	
	GVEQ-CH2			f = 15kHz, Vin = -46dB	SW22 (L), SW23 (R) OFF	23.5	25.5	27.5	dB	5	38	7	36	—	
	GVEQ-CH3			f = 20kHz, Vin = -46dB	SW22 (L), SW23 (R) OFF	26.5	29.0	31.5	dB	5	38	7	36	—	
REC-MUTE attenuation	REC-MUTE	NORM	NORM	f = 1kHz, Vin = -14dB	SW22 (L), SW23 (R) OFF	60	70	—	dB	5	38	7	36	—	
REC CAL response	R-CAL1	NORM	NORM	f = 3kHz, Vin = -46dB, VREC-CAL = 5V	SW22 (L), SW23 (R) OFF	3.0	4.5	6.0	dB	5	38	7	36	—	
	R-CAL2			f = 3kHz, Vin = -46dB, VREC-CAL = 0V	SW22 (L), SW23 (R) OFF	-6.0	-4.5	-3.0	dB	5	38	7	36	—	
GP CAL response	GP-CAL1	NORM	NORM	f = 12kHz, Vin = -46dB, VGP-CAL = 0V	SW22 (L), SW23 (R) OFF	3.0	4.5	6.0	dB	5	38	7	36	—	
	GP-CAL2			f = 12kHz, Vin = -46dB, VGP-CAL = 5V	SW22 (L), SW23 (R) OFF	-6.0	-4.5	-3.0	dB	5	38	7	36	—	
ALC CAL response	ALC-CAL1	NORM	NORM	f = 1kHz, VALC-CAL = 0V	ALC (1) = 0dB	—	-4.0	-3.0	dB	56	43	4	39	—	
	ALC-CAL2			f = 1kHz, VALC-CAL = 5V		3.0	4.0	—	dB	56	43	4	39	—	
Bias out maximum level	Bias on		R _L = 2.2kΩ		V _{CC}	V _{CC}	-1.4	-0.7	V	—	—	—	—	32, 33	
Bias out offset	Bias off		R _L = 2.2kΩ		-0.1	0.0	0.1	V	V	—	—	—	—	—	
Control voltage	V _L					-0.2	—	1.0	V	—	—	—	—	15 to 20 22 to 25	
	V _M					2.0	—	3.0	V	—	—	—	—	19, 24	
	V _H					4.0	—	V _{CC}	V	—	—	—	—	15 to 20 22 to 25	

HA12227F

(Ta = 25°C, V_{CC} = 12 V, Dolby Level = REC-OUT Level = 300 mVrms = 0 dB)

Item	Symbol	Test Condition										Application Terminal							
		IC Condition *1					RECOUT level (dB)	Other	Min	Typ	Max	Unit	Input		Output				
		REC/PB /PASS	ALC ON/OFF	A/B	120μ/70μ	MUTE							B N/C	f _{in} (Hz)	R	L	R	L	COM
Quiescent current	I _Q	PB	OFF	A	120	OFF	NORM	—	—	—	—	—	—	—	—	—	—	21	
Input AMP . gain	G _v PB	PB	OFF	A/B	120	OFF	NORM	1k	0	—	—	25.5	27.0	28.5	dB	51/53	48/46	3	40
	G _v REC	REC	OFF	A	120	OFF	NORM	1k	0	—	—	25.0	26.5	28.0	dB	56	43	3	40
Signal handling	V _o max	REC	OFF	A	120	OFF	NORM	1k	—	—	—	12.0	13.0	—	dB	56	43	4	39
Signal to noise ratio	S/N	REC	OFF	A	120	OFF	NORM	1k	—	—	—	64.0	70.0	—	dB	56	43	4	39
Total Harmonic Distortion	THD	REC	OFF	A	120	OFF	NORM	1k	0	—	—	—	0.05	0.3	%	56	43	4	39
Channel separation	CTRL (1)	PB	OFF	A	120	OFF	NORM	1k	+12	—	—	70.0	80.0	—	dB	51	48	3	40
	CTRL (2)	REC	OFF	A	120	OFF	NORM	1k	+12	—	—	70.0	85.0	—	dB	56	43	3	40
Crosstalk	CT A/B	PB	OFF	A/B	120	OFF	NORM	1k	+12	—	—	70.0	80.0	—	dB	51/53	48/46	3	40
	CT R/P	REC/PB	OFF	A	120	OFF	NORM	1k	+12	—	—	70.0	80.0	—	dB	51/56	48/43	3	40
Pass AMP . gain	G _v PA	PASS	OFF	A/B	120	OFF	NORM	1k	0	—	—	25.5	27.0	28.5	dB	51/53	48/46	3	40
Gain deviation	ΔG _v	PASS	OFF	A/B	120	OFF	NORM	1k	0	—	—	-1.0	0.0	1.0	dB	51/53	48/46	3	40
MUTE ATT.	MUTE	PB	OFF	A	120	ON	NORM	1k	+12	—	—	70.0	80.0	—	dB	51	48	3	40
70μ EQ gain	G _v EQ 1k	PB	OFF	A	70	OFF	CROM	1k	0	—	—	24.0	25.5	27.0	dB	51	48	3	40
	G _v EQ 10k	PB	OFF	A	70	OFF	CROM	10k	0	—	—	20.8	22.3	23.8	dB	51	48	3	40
MS sensing level	V _{ON}	PB	OFF	A	120	OFF	NORM	5k	—	—	—	-26.0	-22.0	-18.0	dB	51	48	3	40
MS output low level	V _{OL}	PB	OFF	A	120	OFF	NORM	—	—	—	—	—	1.0	1.5	V	51	48	—	26
MS output leak current	I _{OH}	PB	OFF	A	120	OFF	NORM	—	—	—	—	—	—	2.0	μA	—	—	—	26
ALC operate level	ALC (1)	REC	ON	A	120	OFF	NORM	1k	+12	—	—	2.0	4.5	7.0	dB	56	43	4	39
	ALC (2)	REC	ON	A	120	OFF	CROM	1k	+12	—	—	0.0	2.5	5.0	dB	56	43	4	39

Notes: 1. Other IC-condition : REC-MUTE OFF, Normal tape, Normal speed, Bias OFF

2. V_{CC} = 11.0 V

3. For inputting signal to one side channel

HA12226F/HA12227F

HA12227F (cont)

(Ta = 25°C, Vcc = 12 V)

Item	Symbol	TAPE	SPEED	Test Condition		Min	Typ	Max	Unit	Application Terminal					
										Input			Output		
										R	L	R	L	R	L
Equalizer S/N	S/N (EQ)	NORM	NORM	Rg = 5.1kΩ, A-WTG Filter (0dB = -5dBs at EQOUT)	SW22 (L), SW23 (R) OFF	55	58	—	dB	5	38	7	36	—	
	Vin max (EQ)	NORM	NORM	f = 1kHz, THD = 1%, Vin = -26dBs = 0dB	SW22 (L), SW23 (R) OFF	10.5	12.5	—	dB	5	38	7	36	—	
Equalizer total harmonic distortion	T.H.D.1 (EQ)	NORM	NORM	f = 1kHz, Vin = -26dBs	SW22 (L), SW23 (R) OFF	—	0.2	0.5	%	5	38	7	36	—	
	T.H.D.2 (EQ)	NORM	NORM	f = 1kHz, Vin = -30dBs	SW22 (L), SW23 (R) OFF	—	0.2	0.5	%	5	38	7	36	—	
Equalizer offset voltage	Vofs (EQ)	NORM	NORM	No-Signal	SW22 (L), SW23 (R) OFF	-500	0	500	mV	5	38	7	36	—	
	GVEQ-NN1	NORM	NORM	f = 3kHz, Vin = -46dBs	SW22 (L), SW23 (R) OFF	18.8	20.3	21.8	dB	5	38	7	36	—	
Equalizer frequency response (NORM - NORM)	GVEQ-NN2			f = 8kHz, Vin = -46dBs	SW22 (L), SW23 (R) OFF	23.9	25.9	27.9	dB	5	38	7	36	—	
	GVEQ-NN3			f = 12kHz, Vin = -46dBs	SW22 (L), SW23 (R) OFF	30.1	32.6	35.1	dB	5	38	7	36	—	
Equalizer frequency response (CROM - NORM)	GVEQ-CN1	CROM	NORM	f = 3kHz, Vin = -46dBs	SW22 (L), SW23 (R) OFF	23.3	24.8	26.3	dB	5	38	7	36	—	
	GVEQ-CN2			f = 8kHz, Vin = -46dBs	SW22 (L), SW23 (R) OFF	28.5	30.5	32.5	dB	5	38	7	36	—	
Equalizer frequency response (NORM - High)	GVEQ-CN3	NORM	HIGH	f = 12kHz, Vin = -46dBs	SW22 (L), SW23 (R) OFF	34.0	36.5	39.0	dB	5	38	7	36	—	
	GVEQ-NH1			f = 5kHz, Vin = -46dBs	SW22 (L), SW23 (R) OFF	15.0	16.5	18.0	dB	5	38	7	36	—	
Equalizer frequency response (CROM - High)	GVEQ-NH2			f = 20kHz, Vin = -46dBs	SW22 (L), SW23 (R) OFF	19.9	21.9	23.9	dB	5	38	7	36	—	
	GVEQ-NH3			f = 15kHz, Vin = -46dBs	SW22 (L), SW23 (R) OFF	23.4	25.9	28.4	dB	5	38	7	36	—	
Equalizer frequency Response (CROM - High)	GVEQ-CH1	CROM	HIGH	f = 5kHz, Vin = -46dBs	SW22 (L), SW23 (R) OFF	19.7	21.2	22.7	dB	5	38	7	36	—	
	GVEQ-CH2			f = 15kHz, Vin = -46dBs	SW22 (L), SW23 (R) OFF	23.5	25.5	27.5	dB	5	38	7	36	—	
REC-MUTE attenuation	GVEQ-CH3			f = 20kHz, Vin = -46dBs	SW22 (L), SW23 (R) OFF	26.5	29.0	31.5	dB	5	38	7	36	—	
	REC-MUTE	NORM	NORM	f = 1kHz, Vin = -14dBs	SW22 (L), SW23 (R) OFF	60	70	—	dB	5	38	7	36	—	
REC CAL response	R-CAL1	NORM	NORM	f = 3kHz, Vin = -46dBs, VREC-CAL = 5V	SW22 (L), SW23 (R) OFF	3.0	4.5	6.0	dB	5	38	7	36	—	
	R-CAL2			f = 3kHz, Vin = -46dBs, VREC-CAL = 0V	SW22 (L), SW23 (R) OFF	-6.0	-4.5	-3.0	dB	5	38	7	36	—	
GP CAL response	GP-CAL1	NORM	NORM	f = 12kHz, Vin = -46dBs, VGP-CAL = 0V	SW22 (L), SW23 (R) OFF	3.0	4.5	6.0	dB	5	38	7	36	—	
	GP-CAL2			f = 12kHz, Vin = -46dBs, VGP-CAL = 5V	SW22 (L), SW23 (R) OFF	-6.0	-4.5	-3.0	dB	5	38	7	36	—	
ALC CAL response	ALC-CAL1	NORM	NORM	f = 1kHz, VALC-CAL = 0V	ALC (1) = 0dB	—	-4.0	-3.0	dB	56	43	4	39	—	
	ALC-CAL2			f = 1kHz, VALC-CAL = 5V		3.0	4.0	—	dB	56	43	4	39	—	
Bias out maximum level	Bias on		R _L = 2.2kΩ		V _{CC}	V _{CC}	—	—	V	—	—	—	—	—	
Bias out offset	Bias off		R _L = 2.2kΩ		V _{CC}	V _{CC}	-0.7	—	V	—	—	—	—	32, 33	
Control voltage	V _L					-0.1	0.0	0.1	V	—	—	—	—	—	
	V _M					-0.2	—	1.0	V	—	—	—	—	15 to 20	
	V _H					2.0	—	3.0	V	—	—	—	—	19, 24	
						4.0	—	V _{CC}	V	—	—	—	—	15 to 20	

Test Circuit

HA12226F

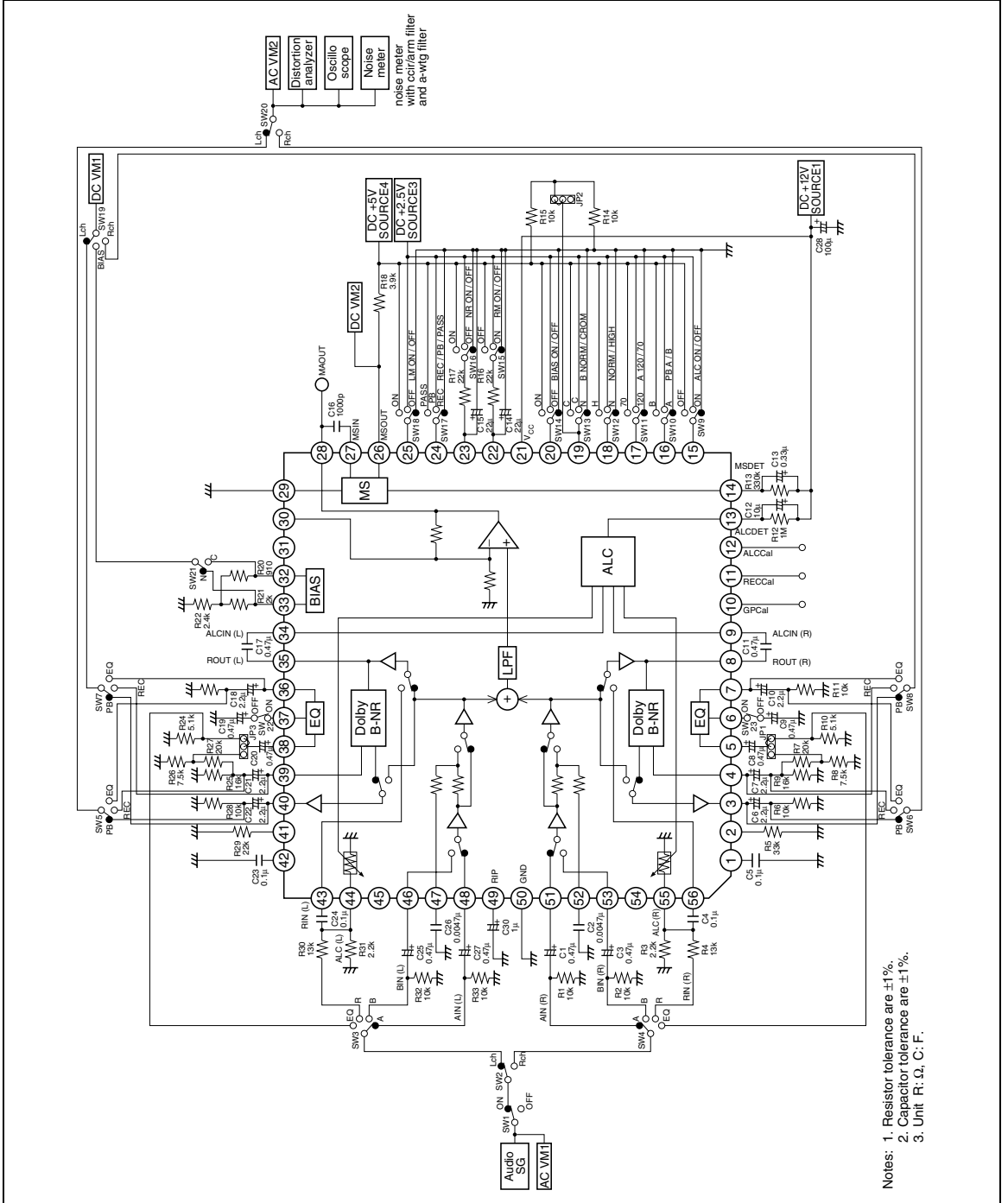

- Notes: 1. Resistor tolerance are ±1%.
- 2. Capacitor tolerance are ±1%.
- 3. Unit R: Ω, C: F.

HA12226F/HA12227F

HA12227F

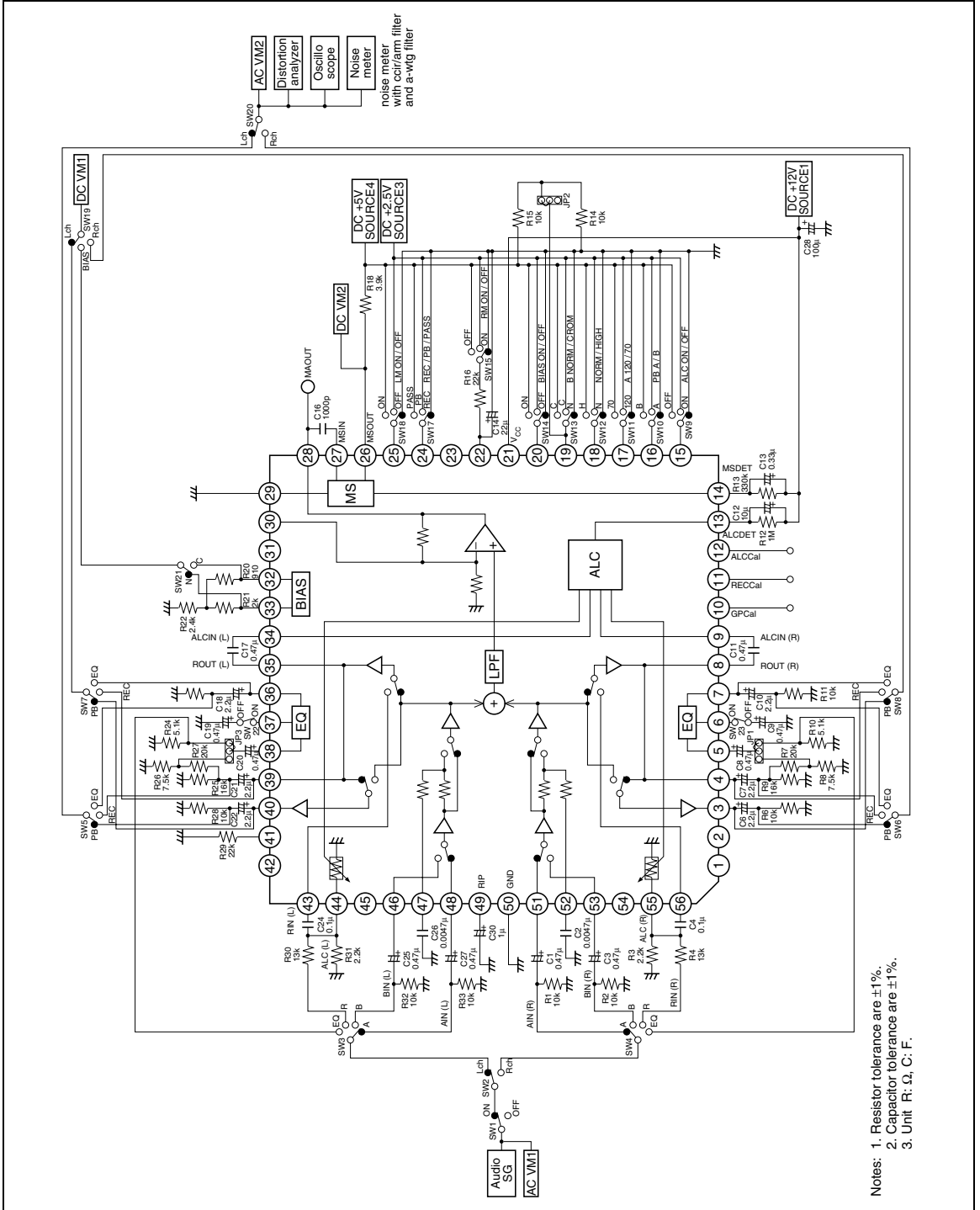

Characteristic Curves

HA12226F

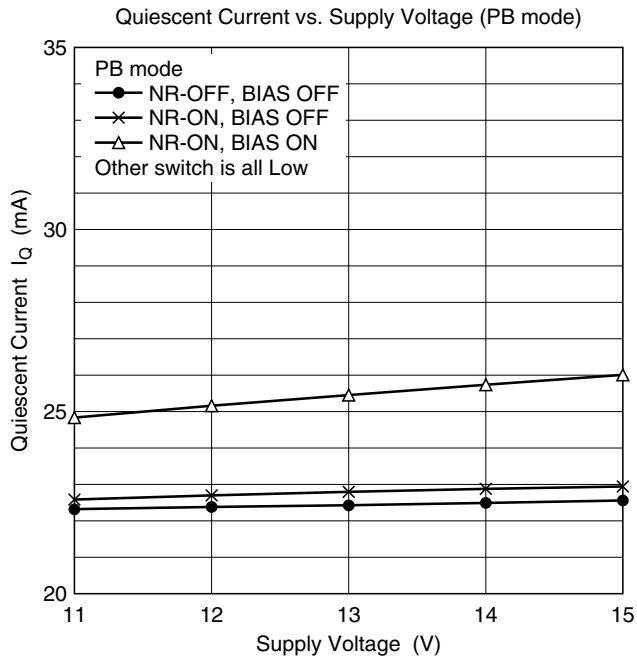
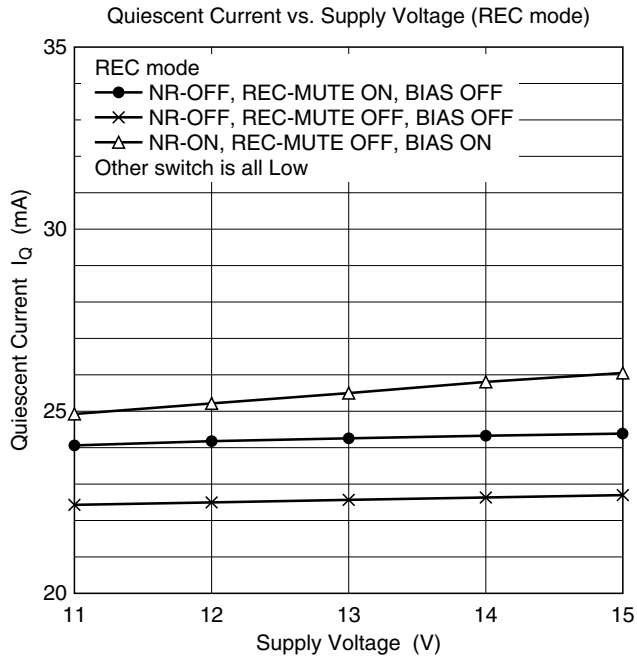

Input Amp. Gain vs. Frequency (1)

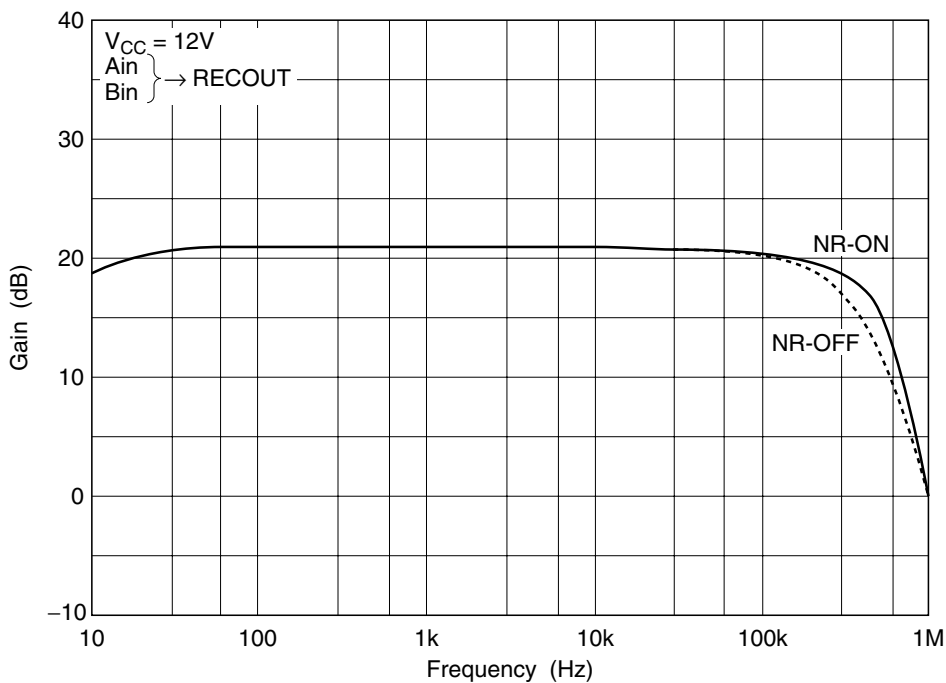

Input Amp. Gain vs. Frequency (2)

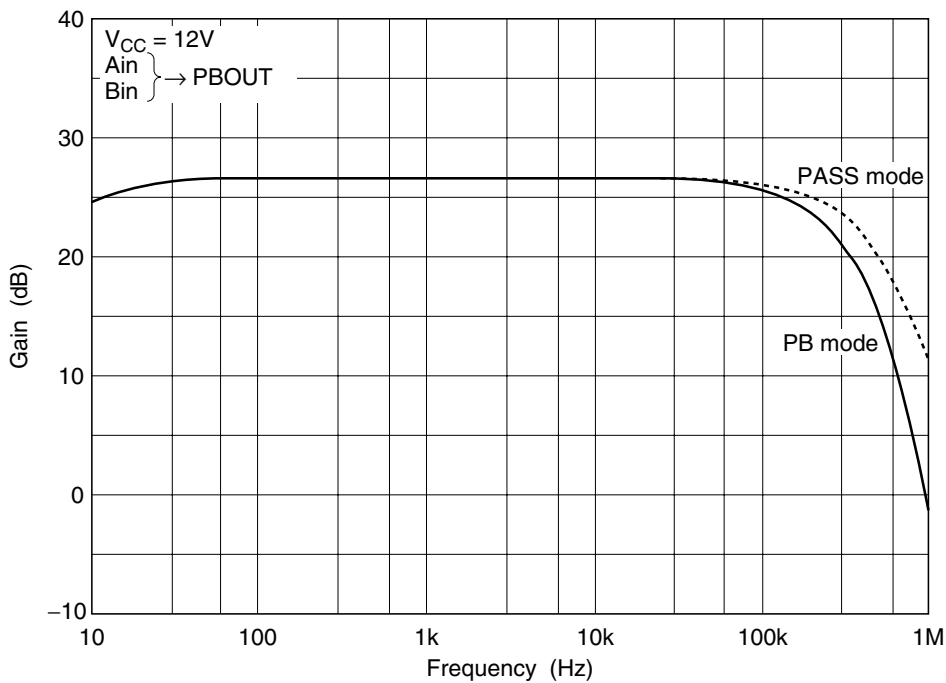

Input Amp. Gain vs. Frequency (3)

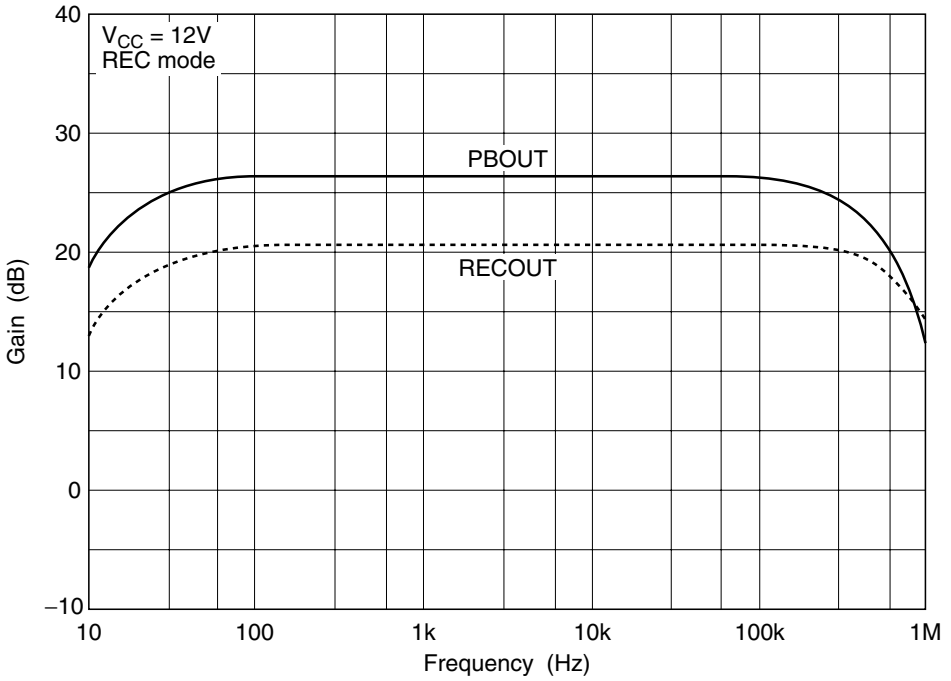

Input Amp. Gain vs. Frequency (4)

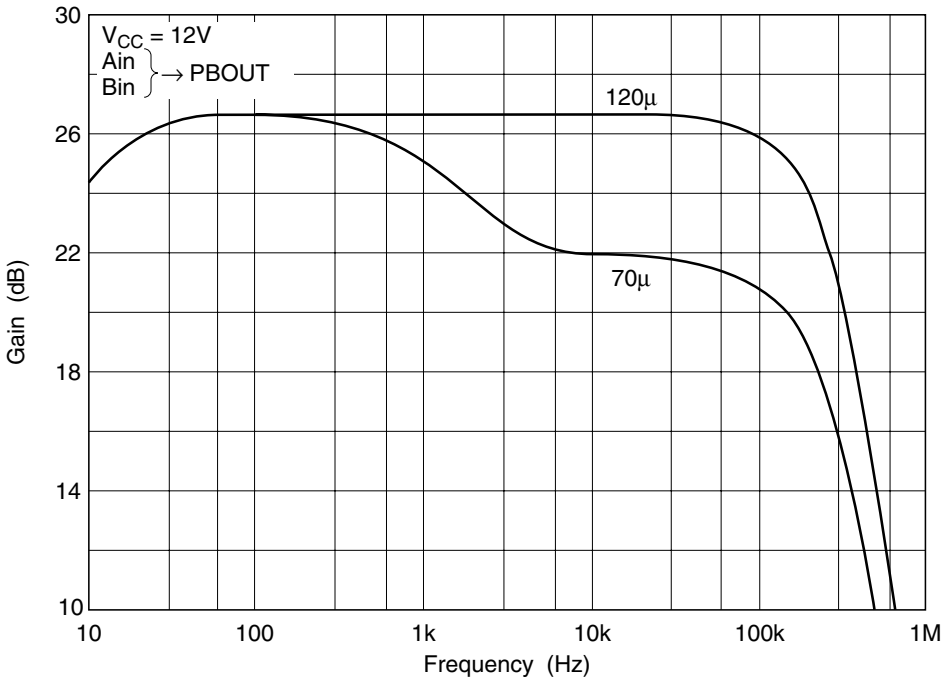

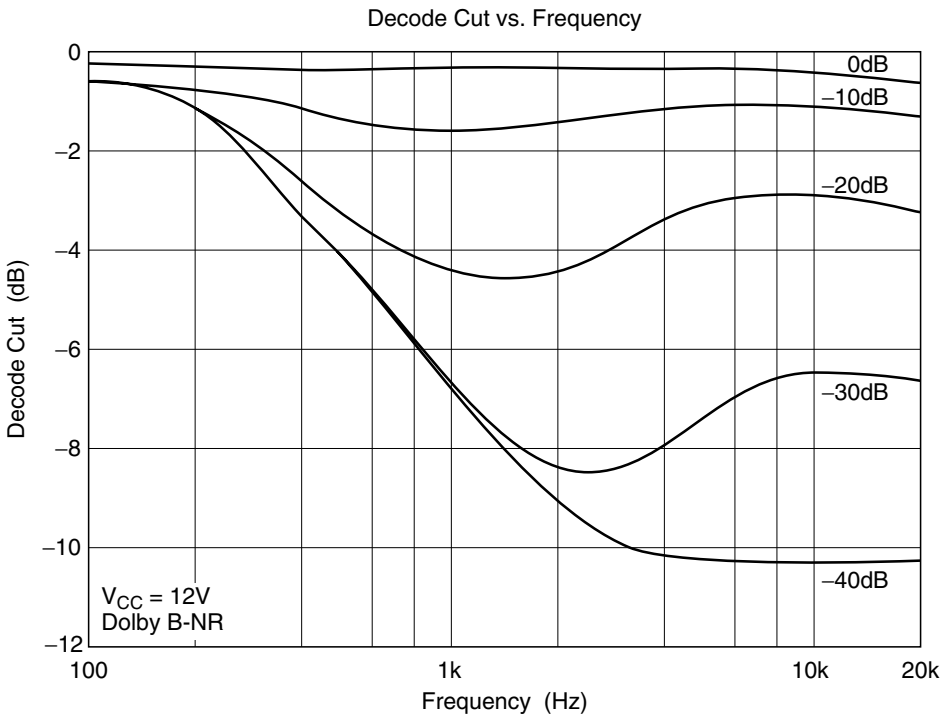
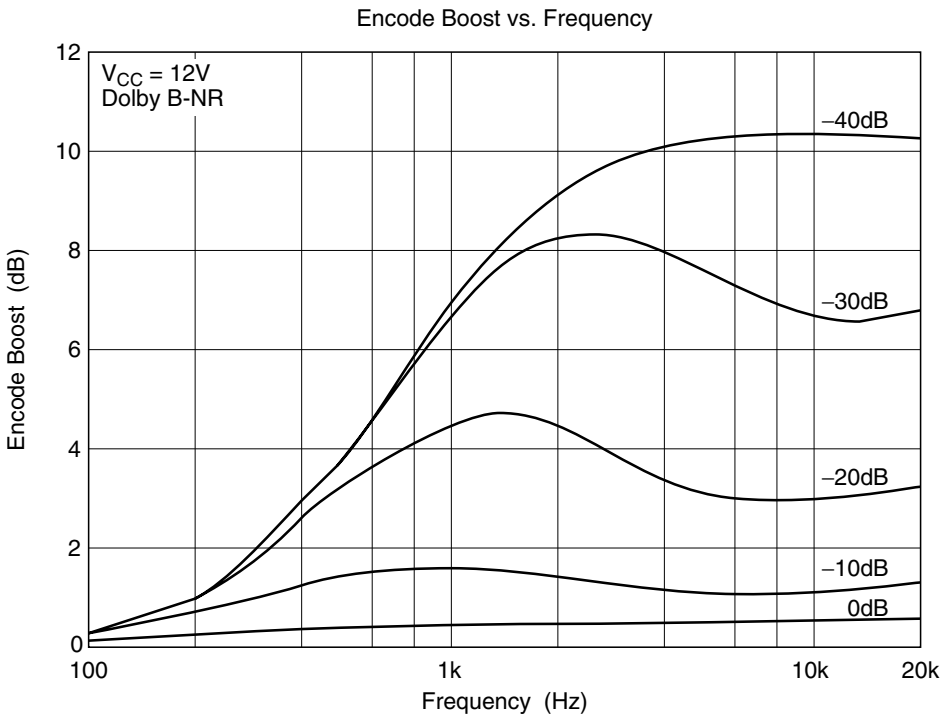

Signal Handling (1)

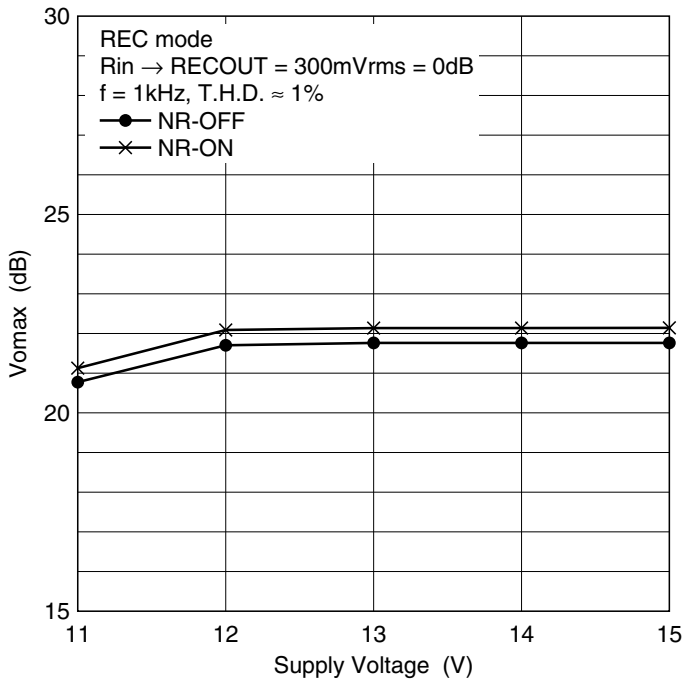

Signal Handling (2)

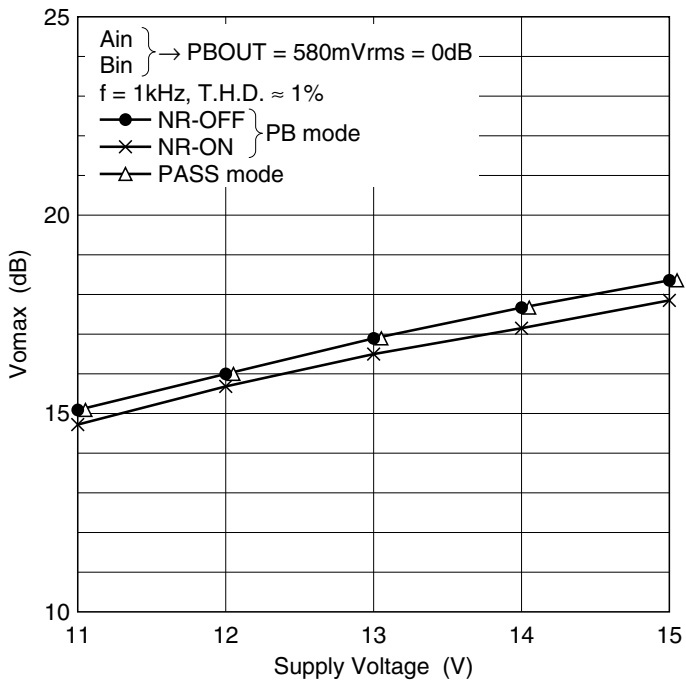

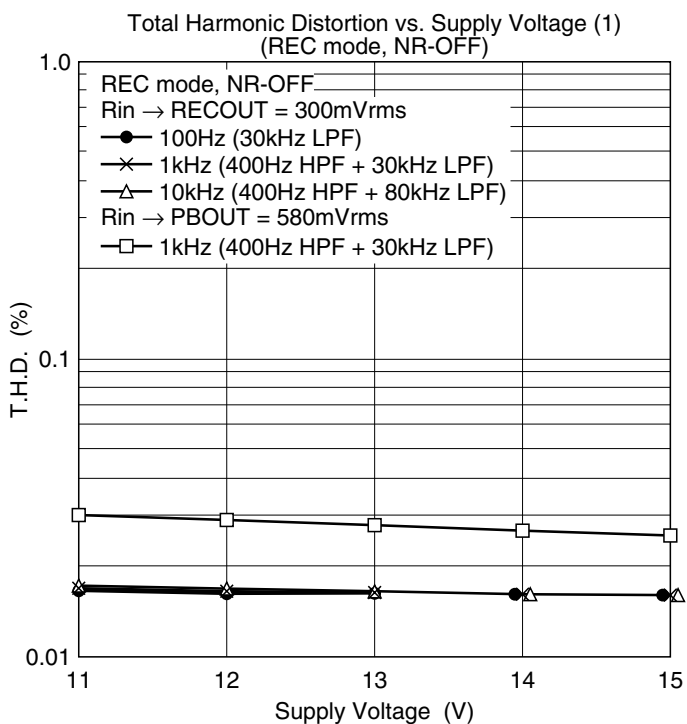
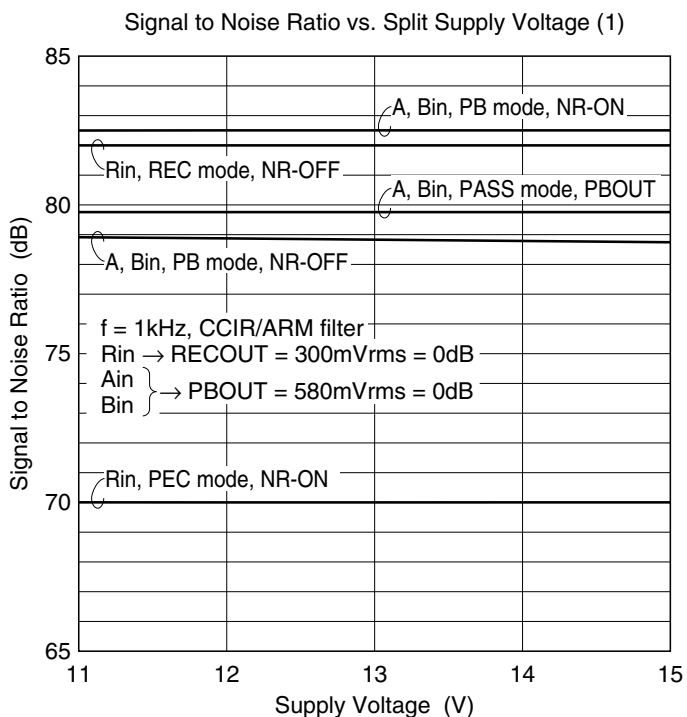

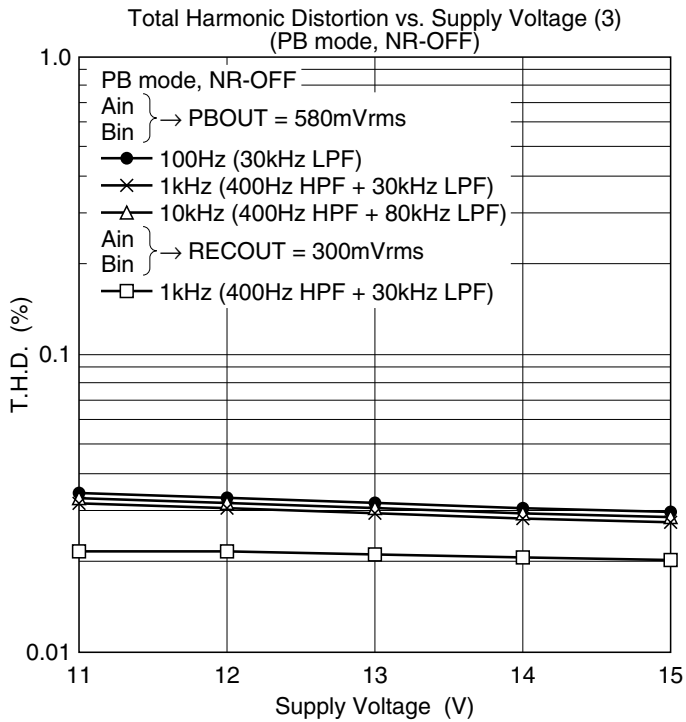
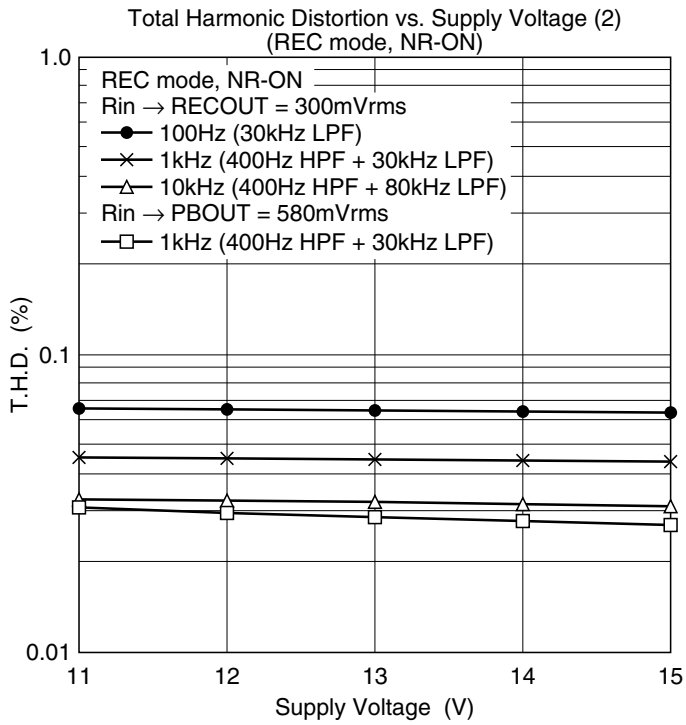

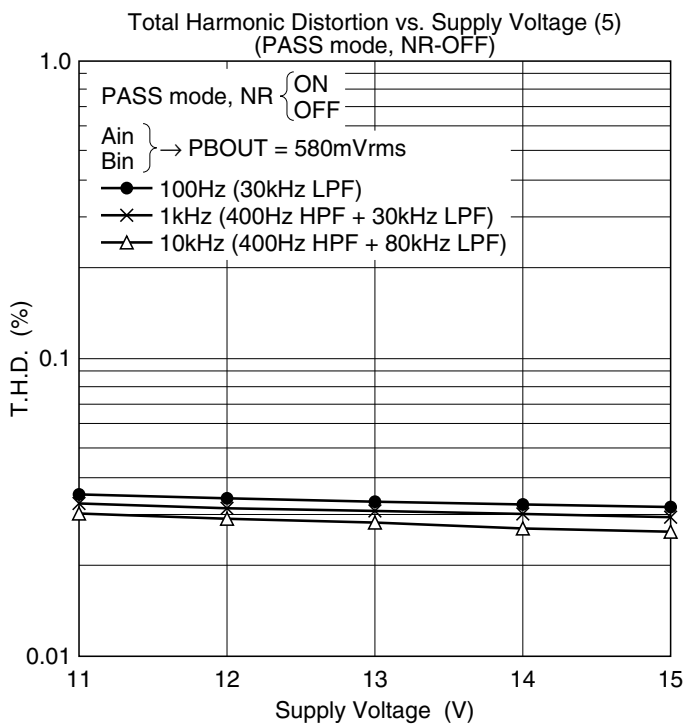
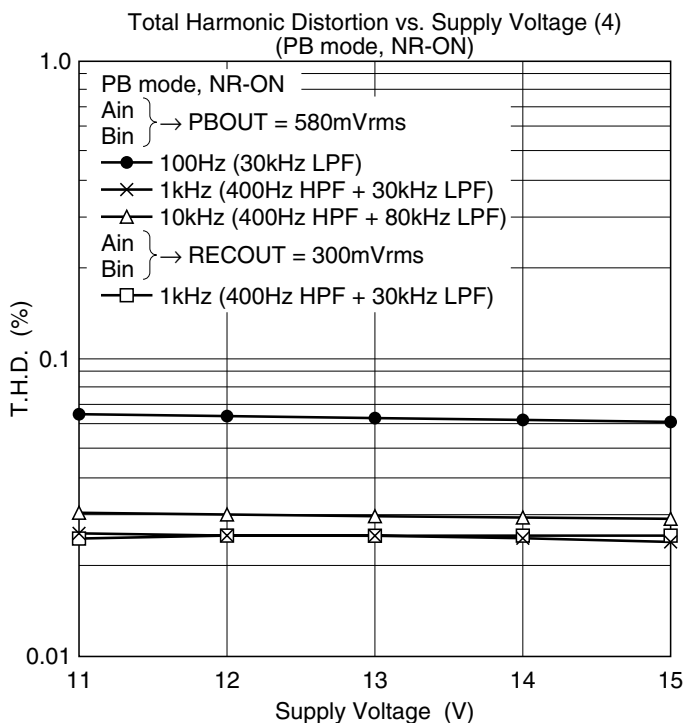

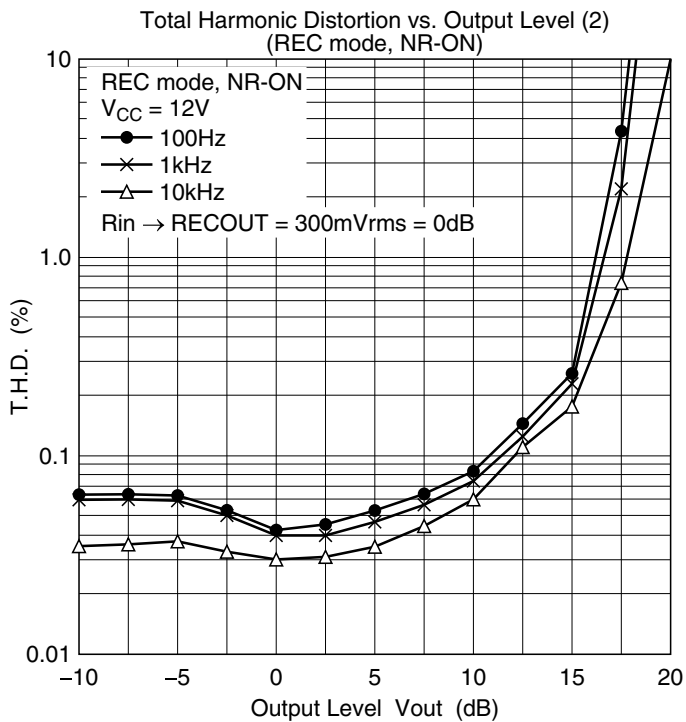
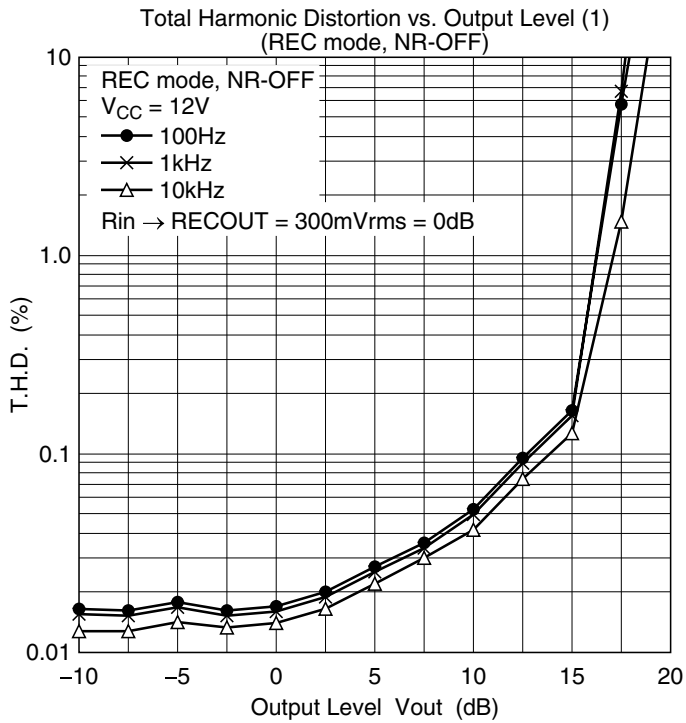

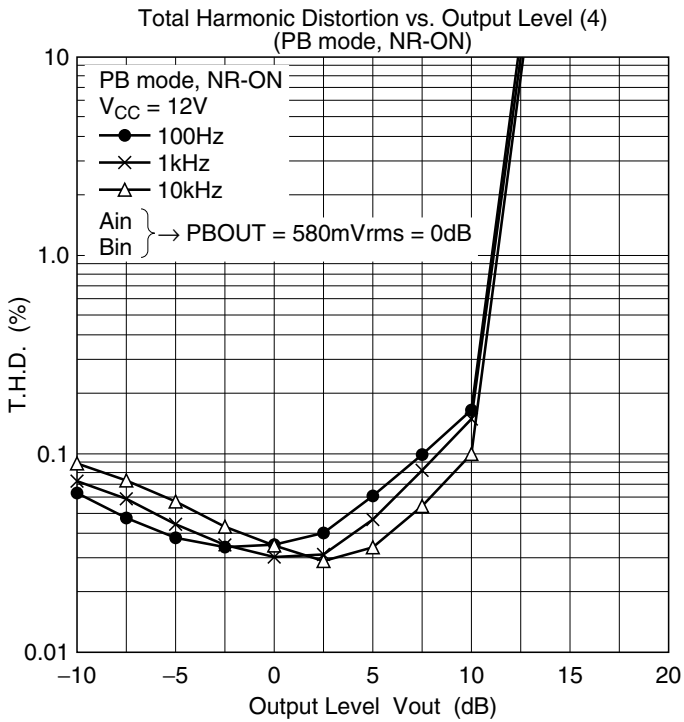
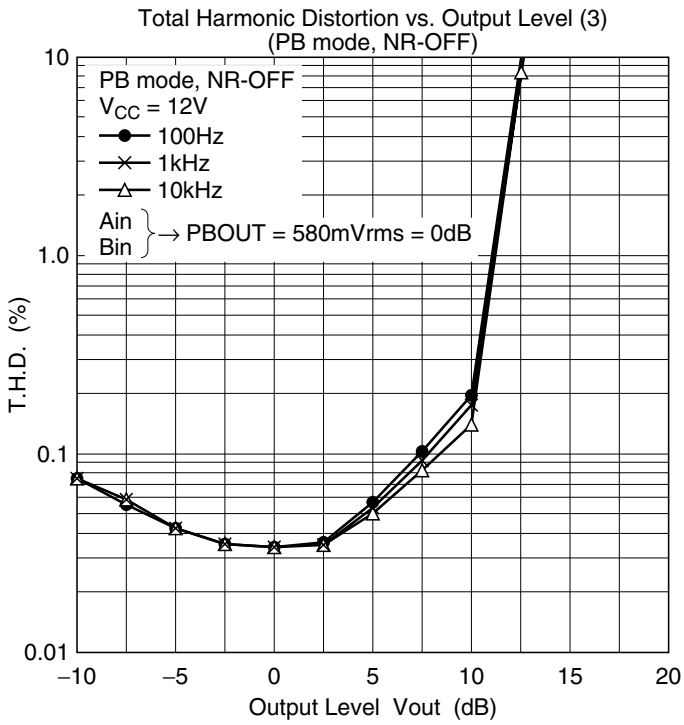

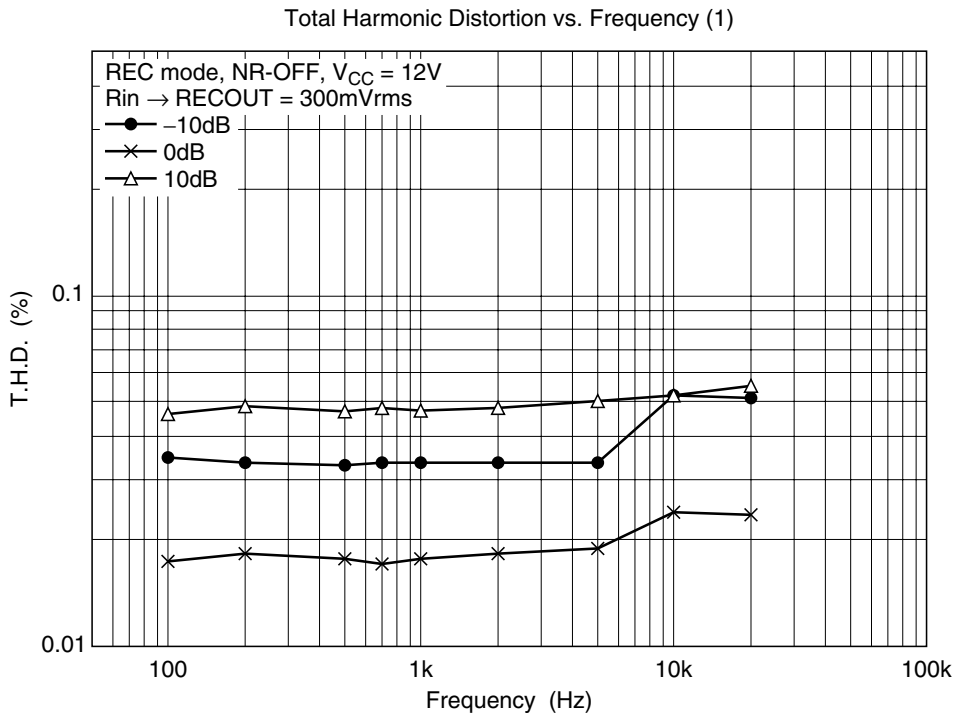
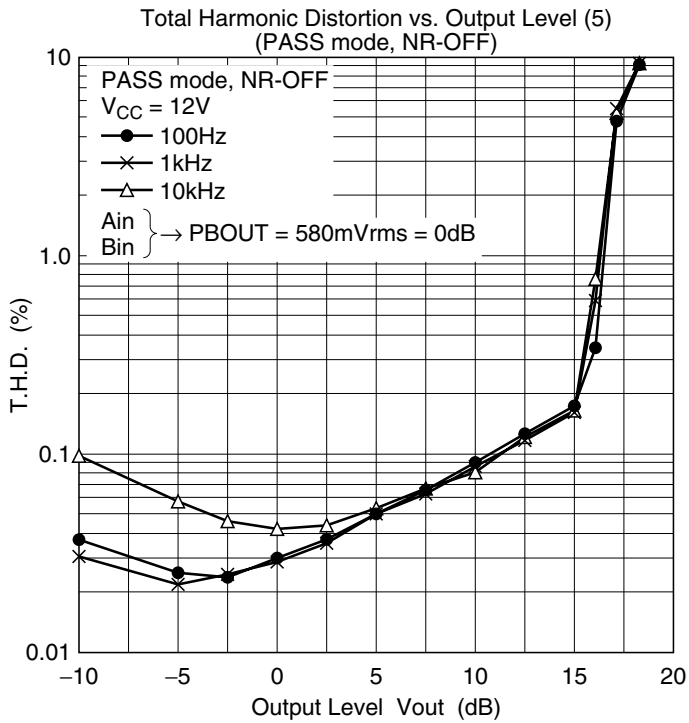

Total Harmonic Distortion vs. Frequency (2)

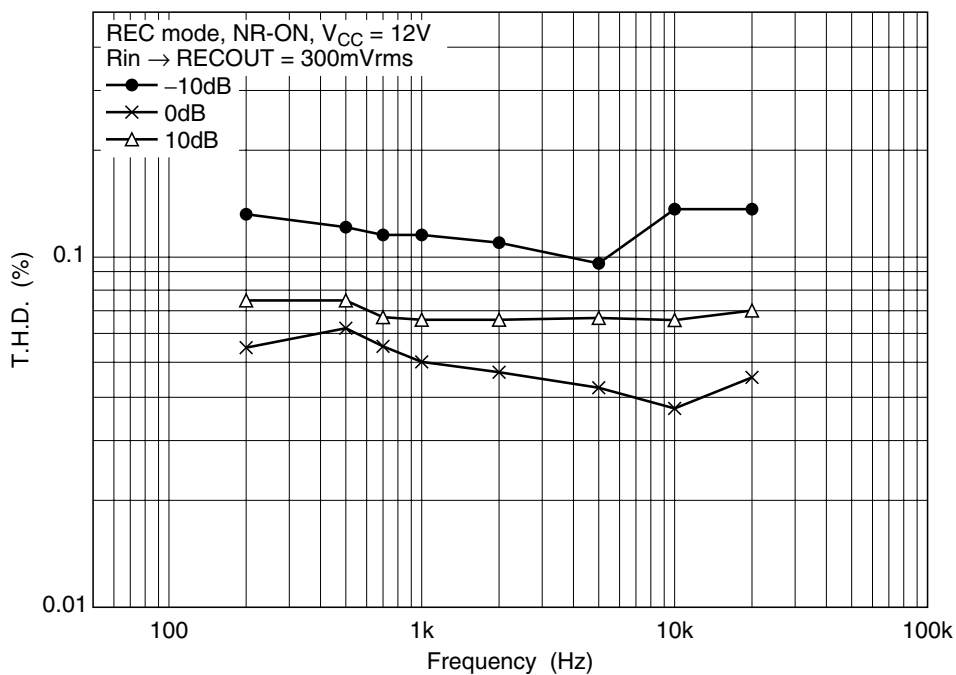

Total Harmonic Distortion vs. Frequency (3)

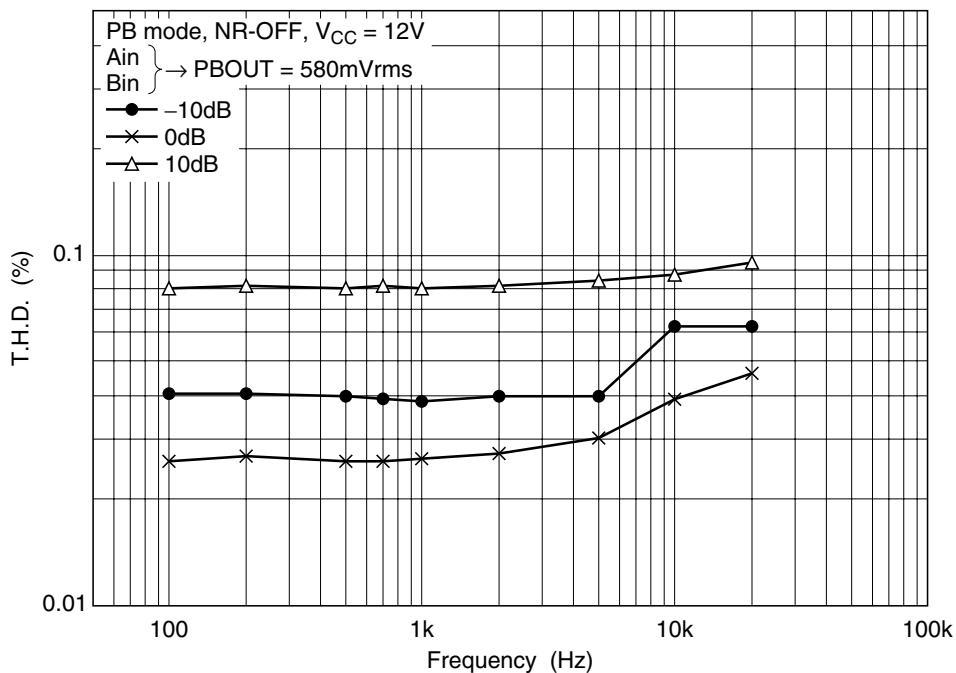

Total Harmonic Distortion vs. Frequency (4)

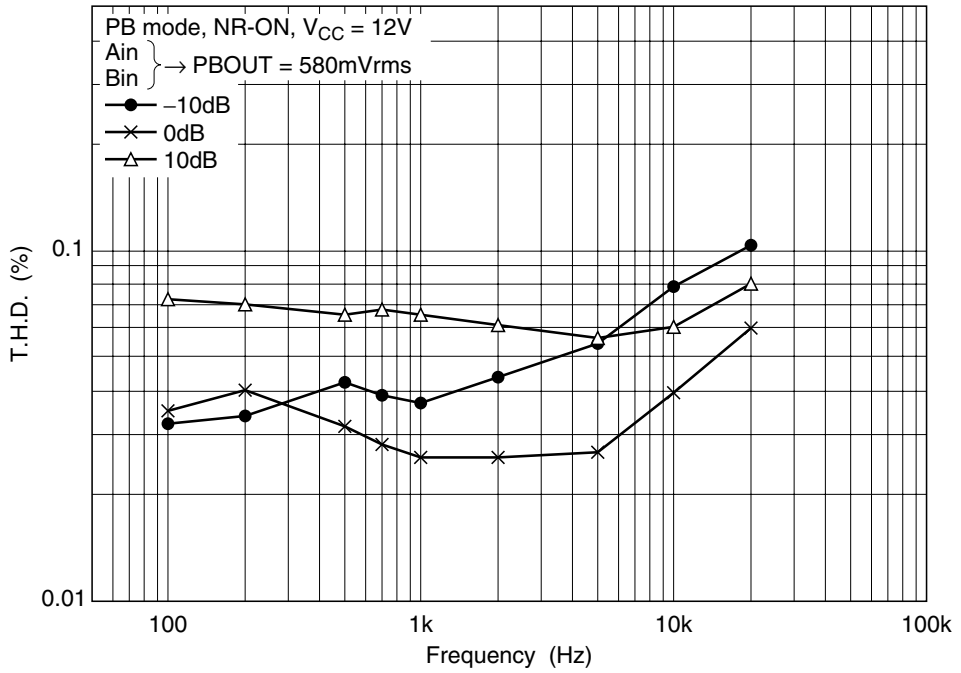

Total Harmonic Distortion vs. Frequency (5)

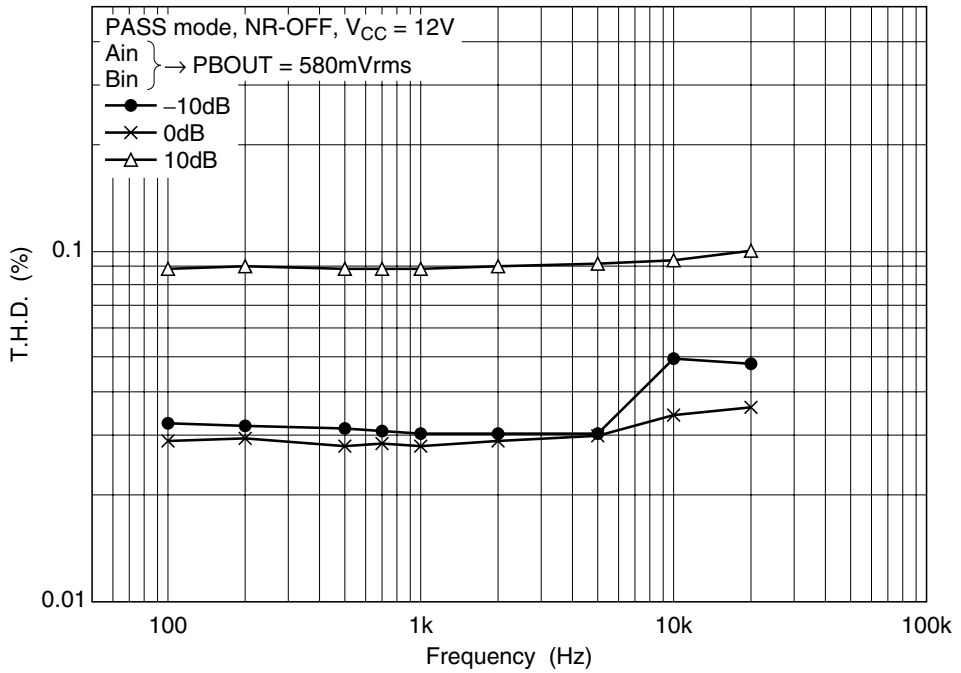

Channel Separation vs. Frequency (R → L) (1)

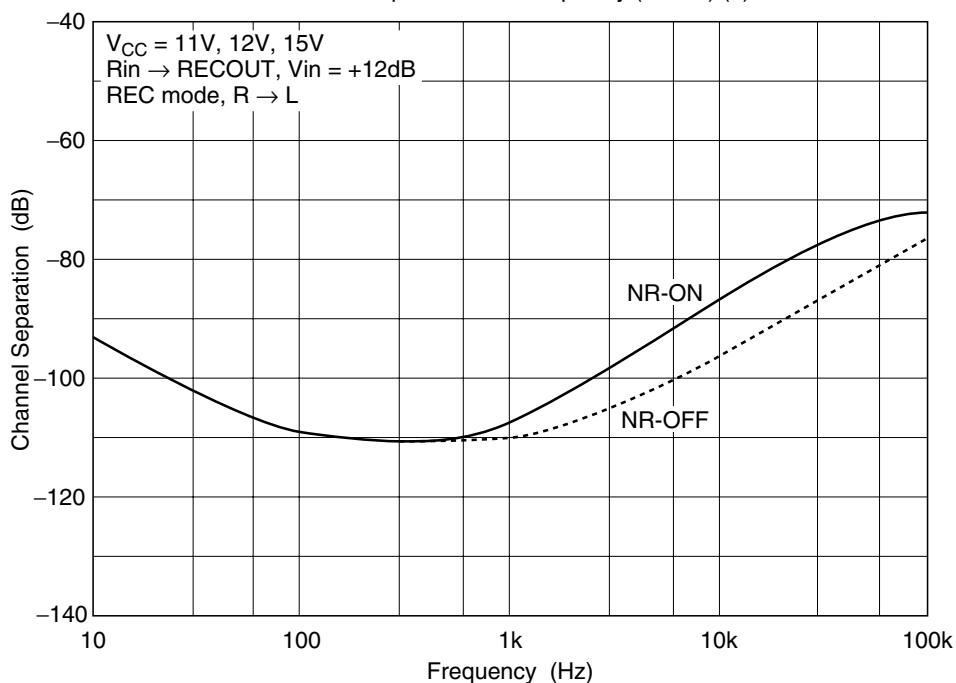

Channel Separation vs. Frequency (R → L) (2)

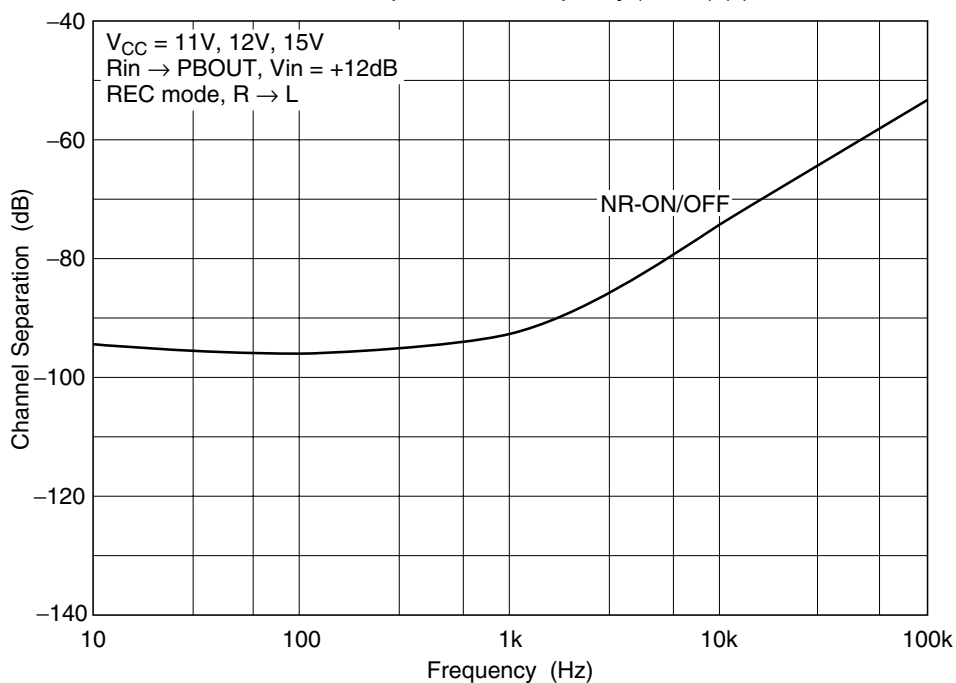

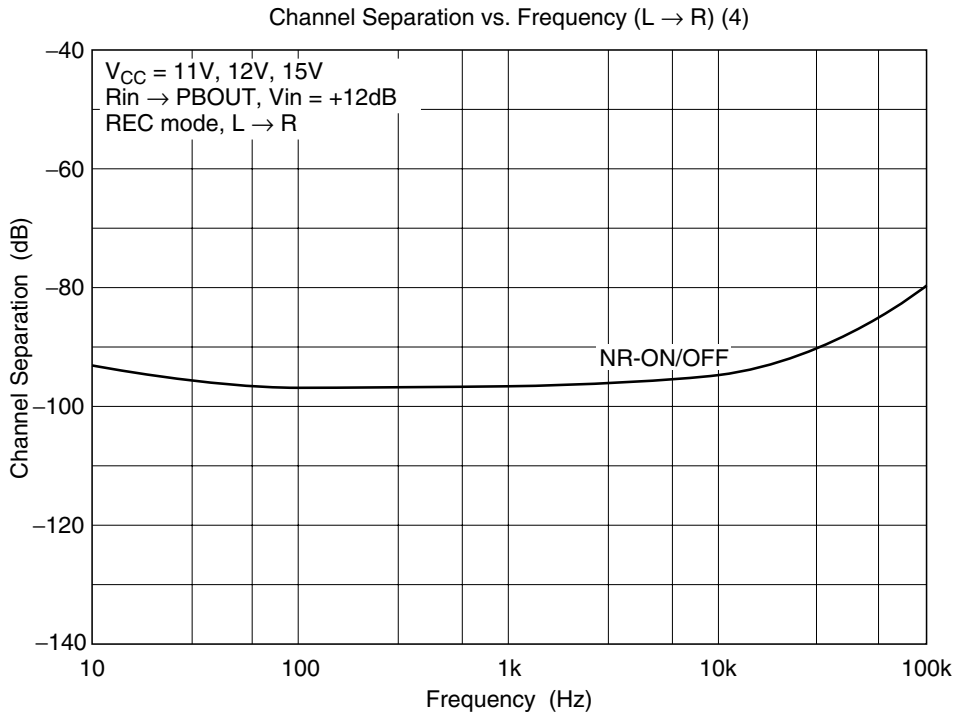
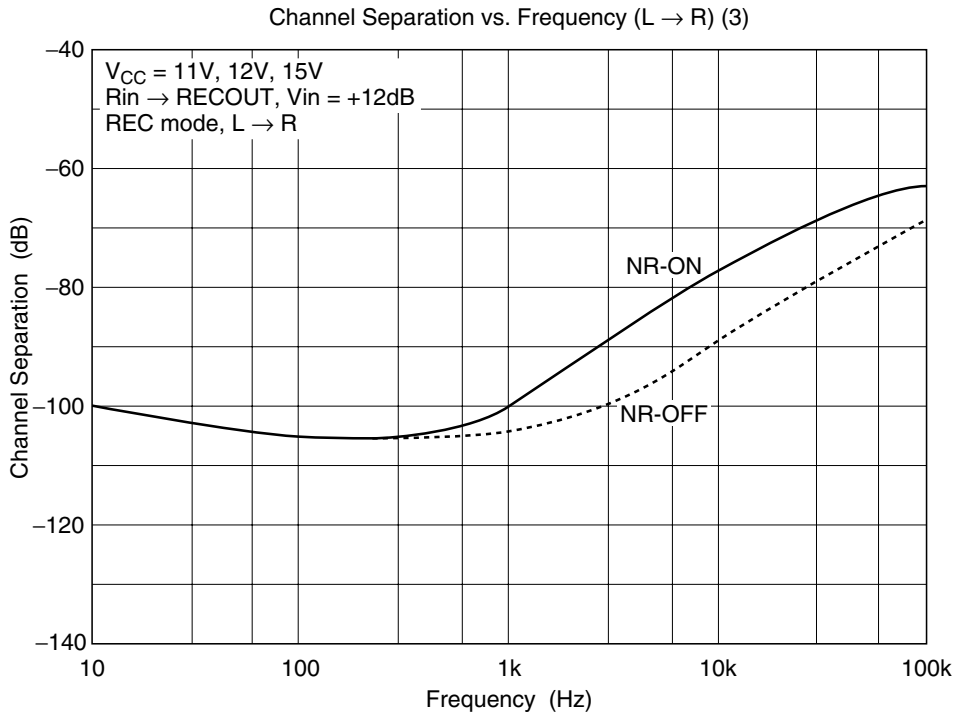

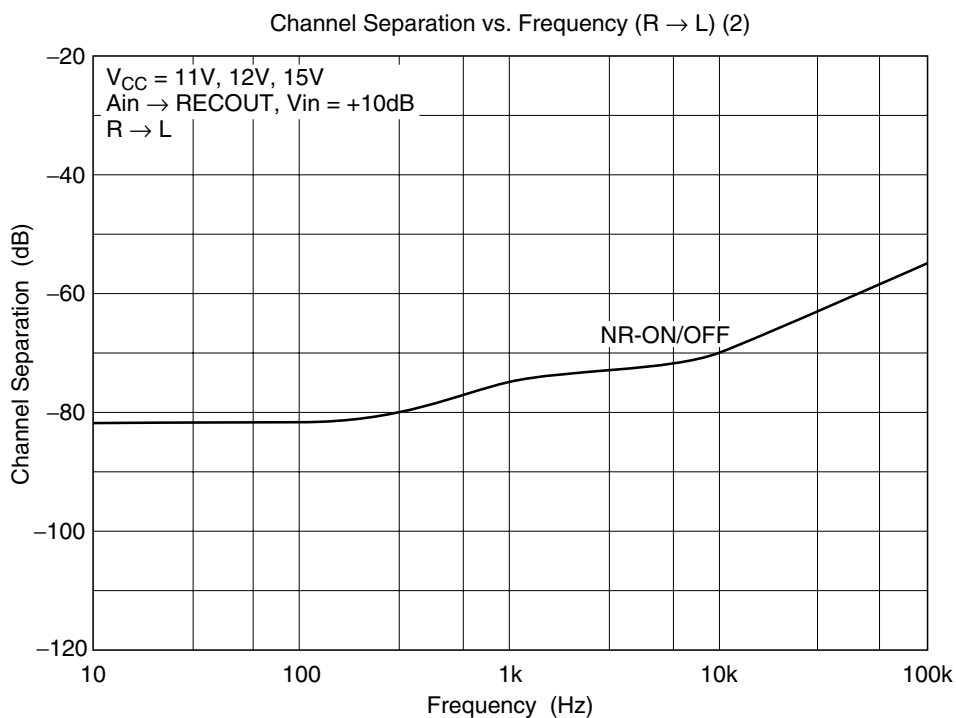
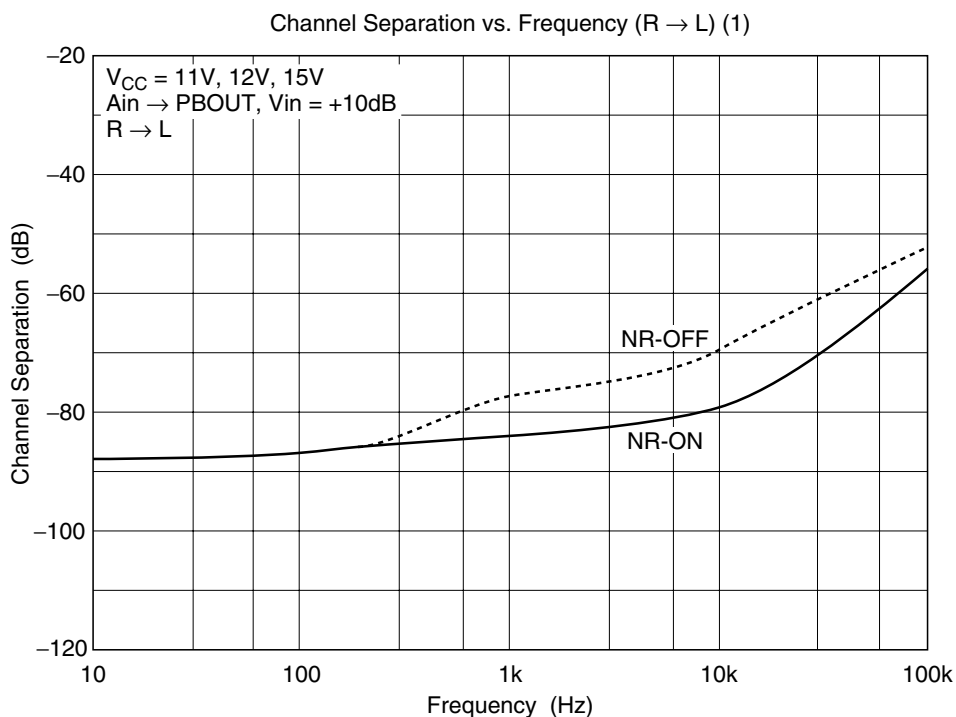

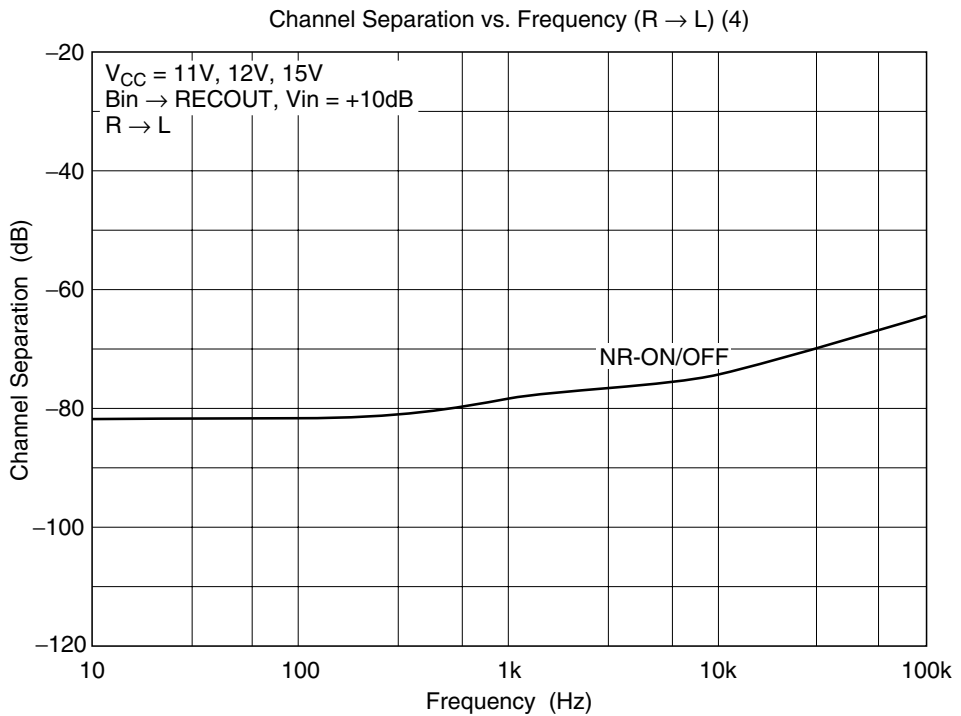
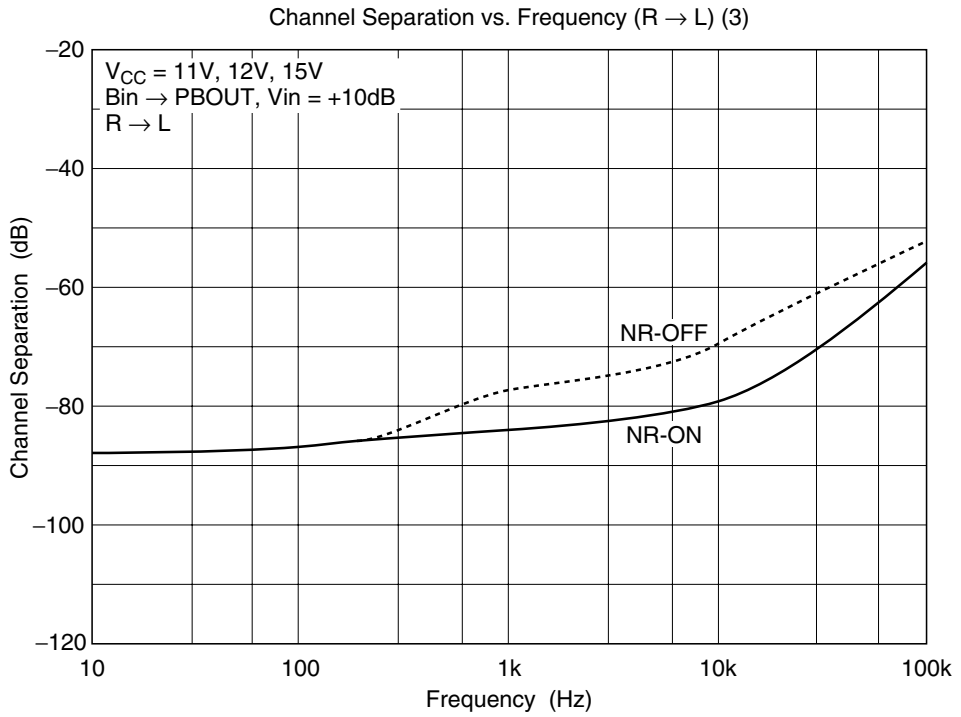

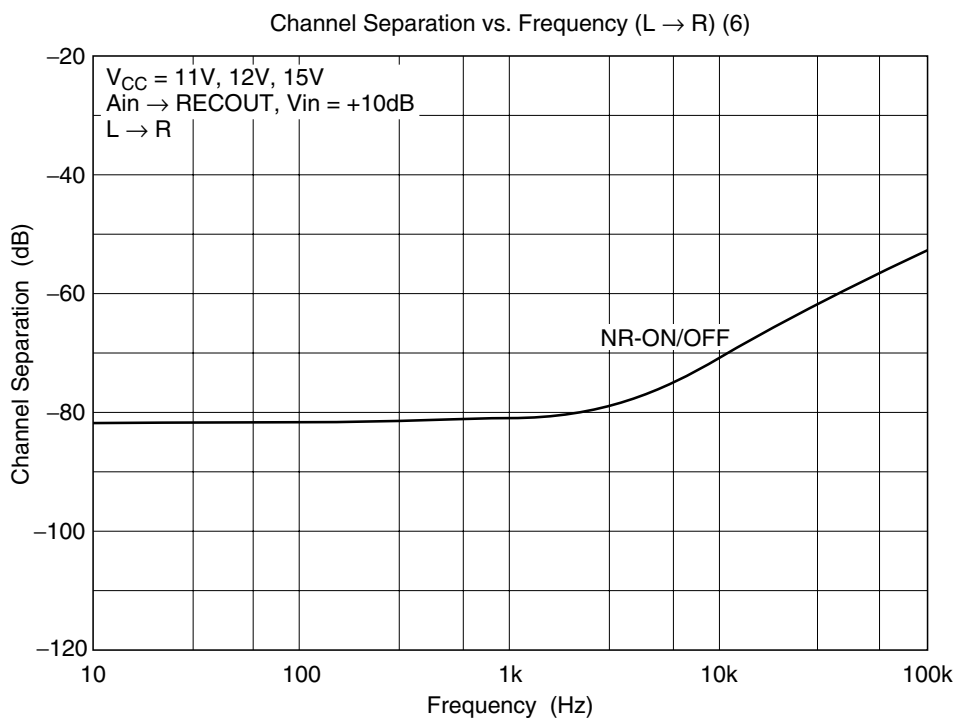
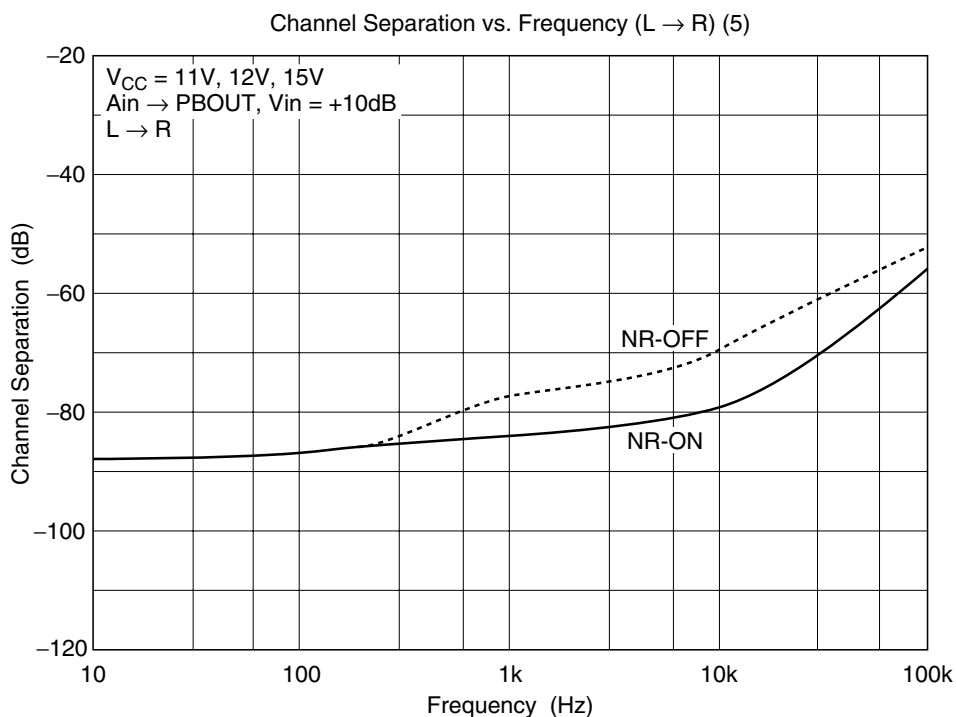

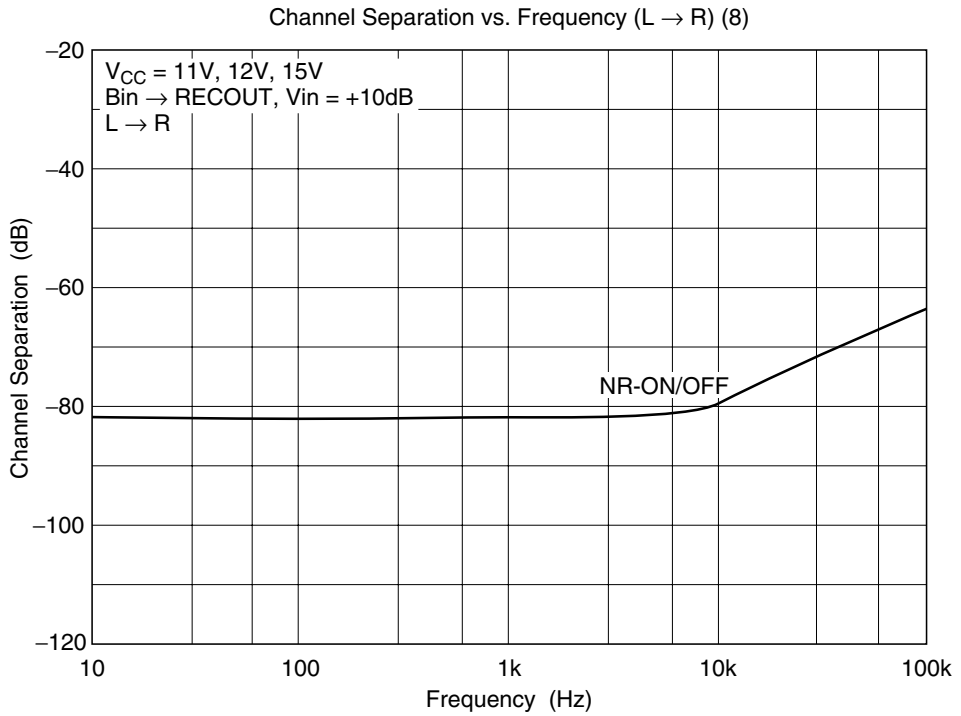
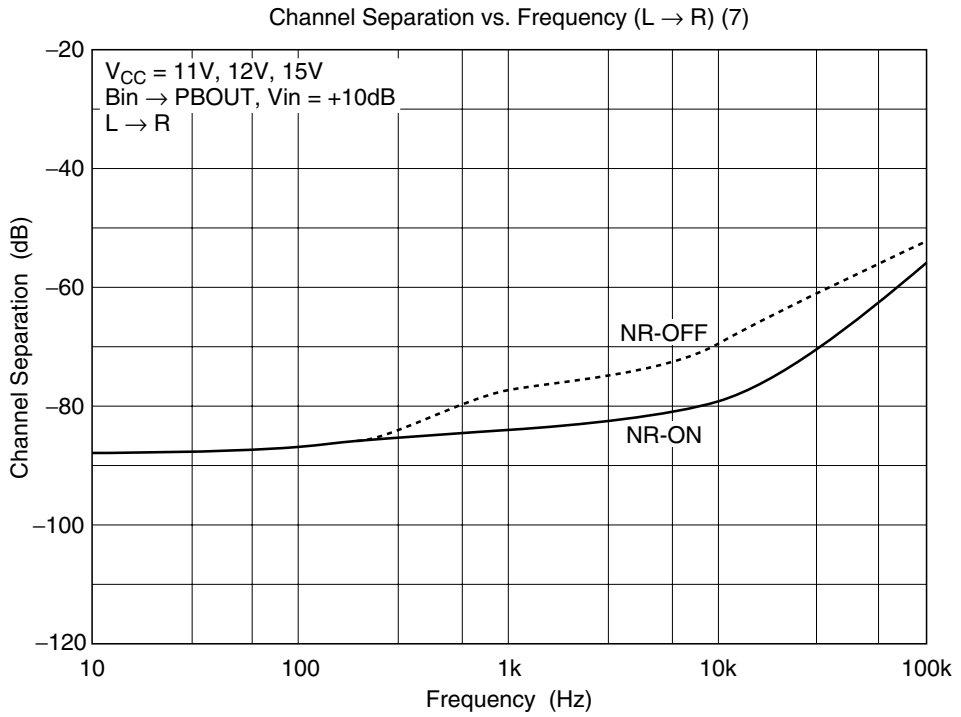

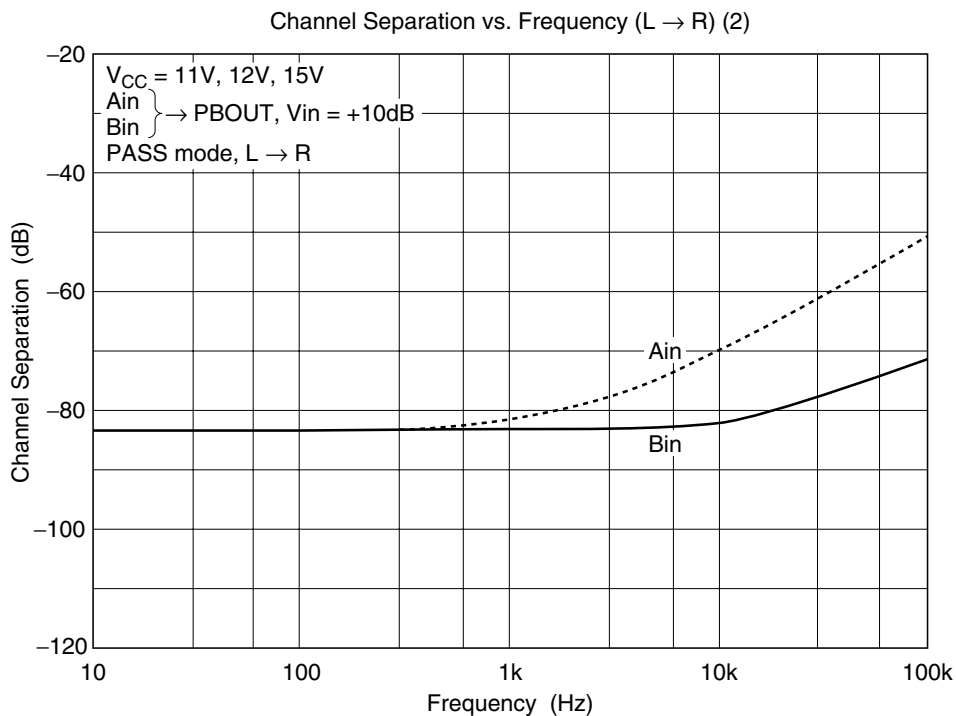
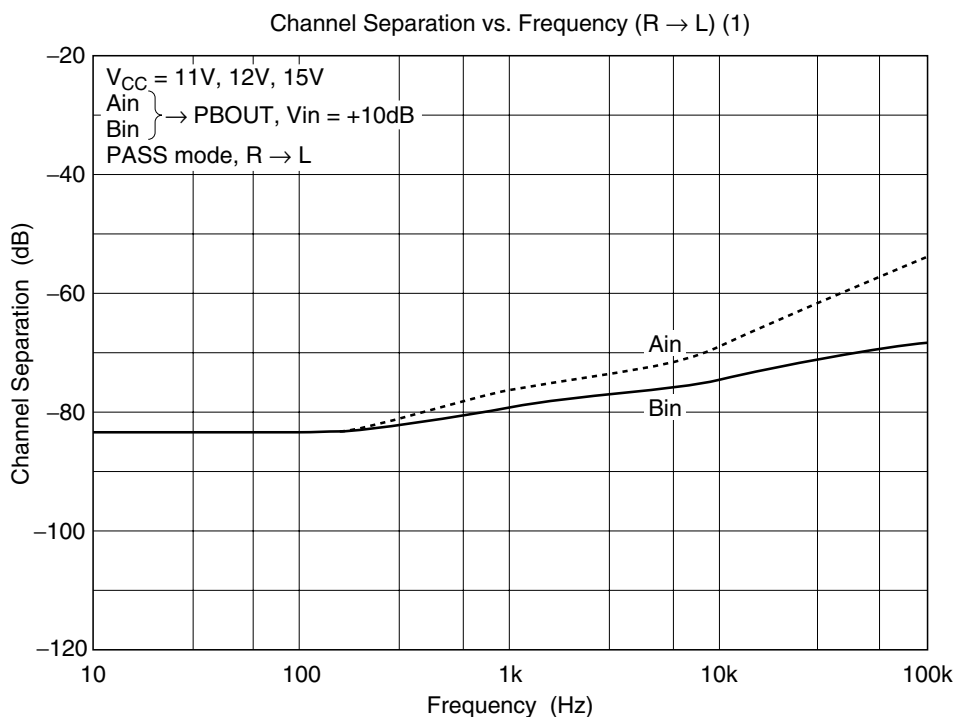

Crosstalk vs. Frequency (Ain → Bin) (1)

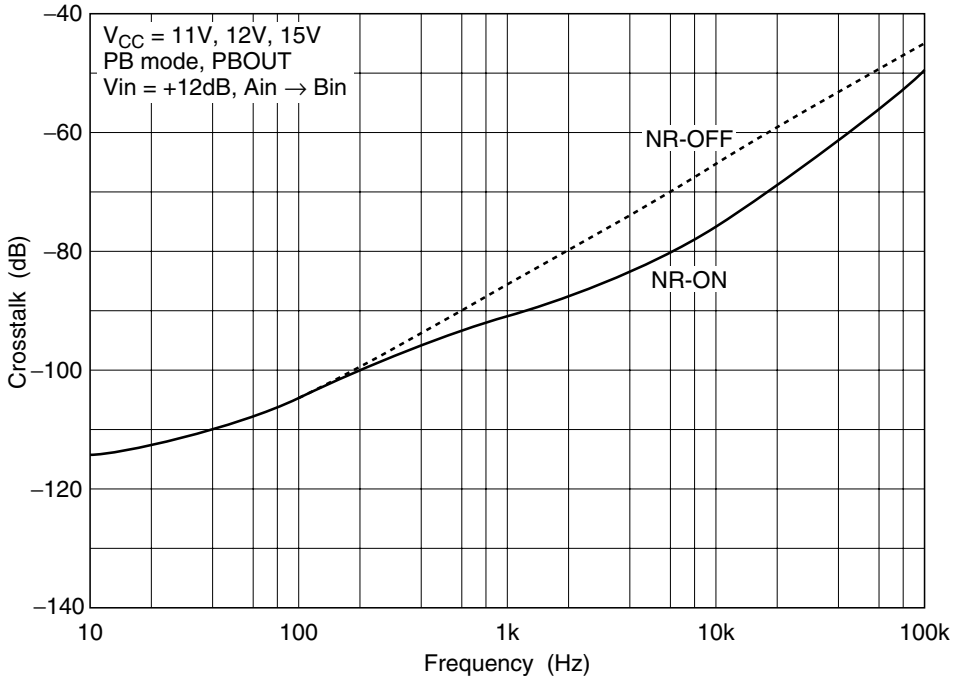

Crosstalk vs. Frequency (Bin → Ain) (2)

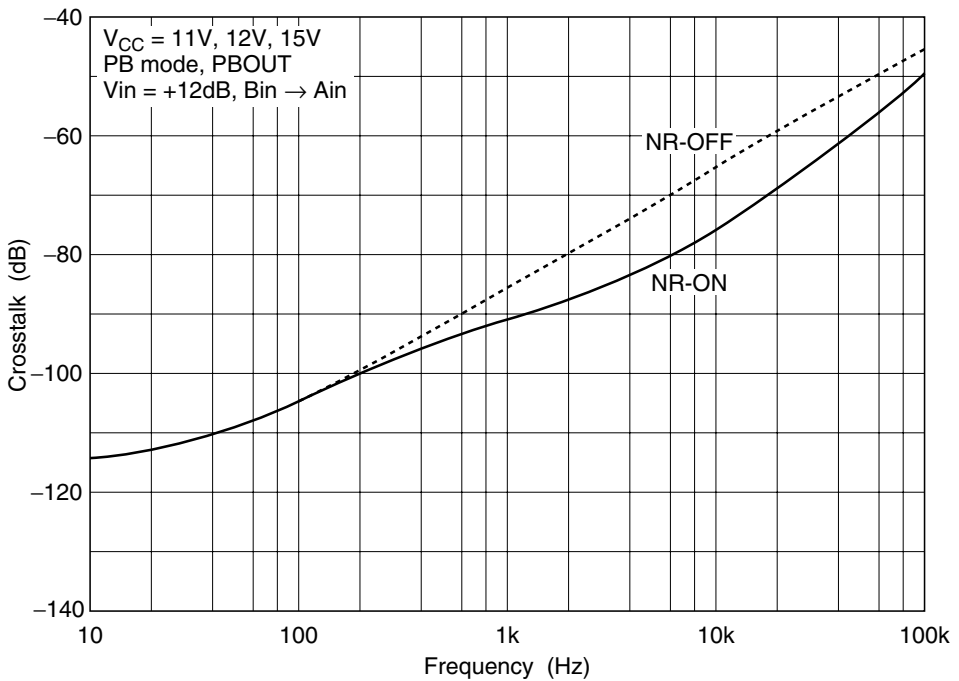

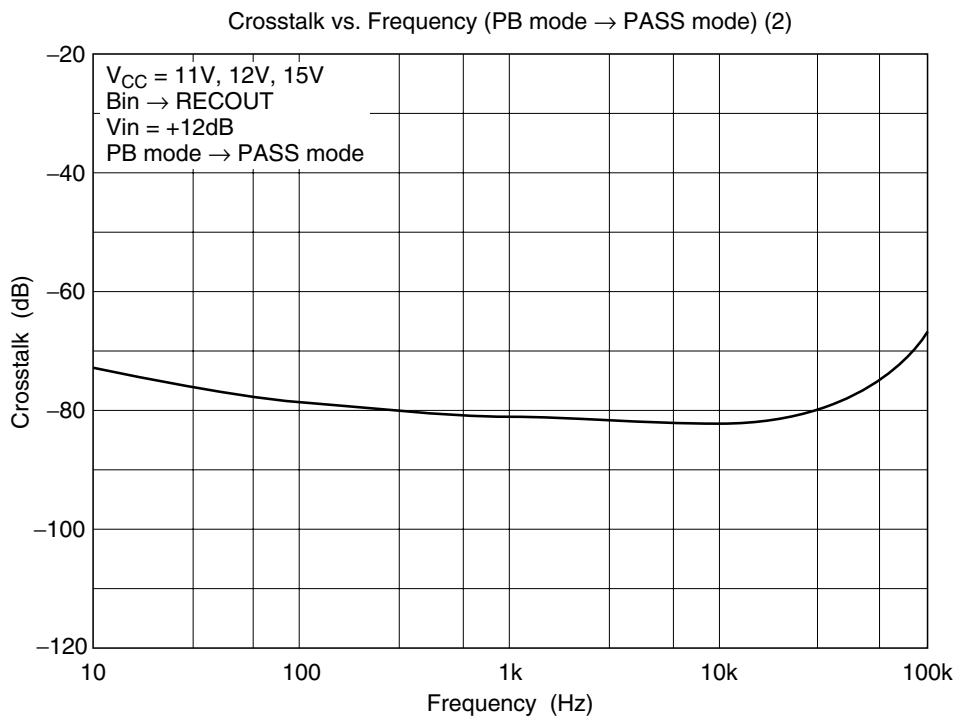
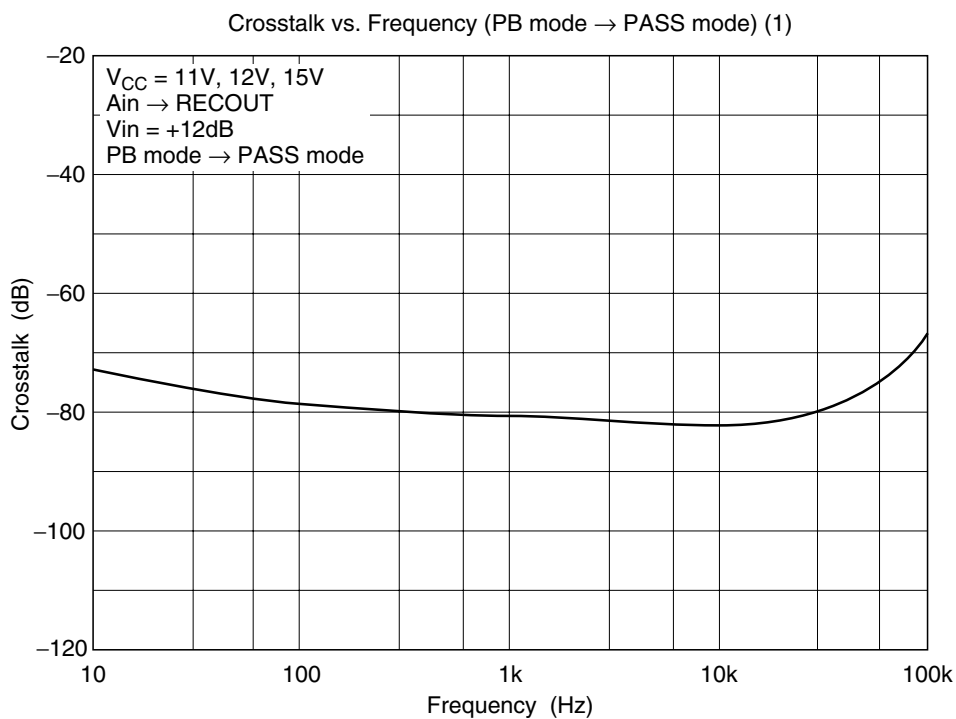

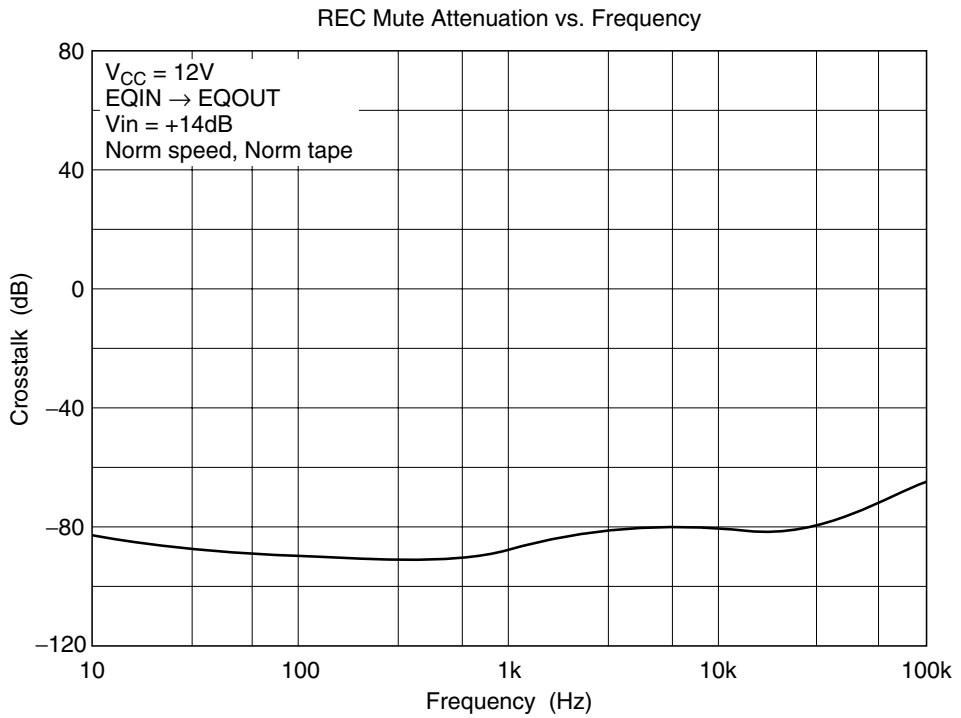
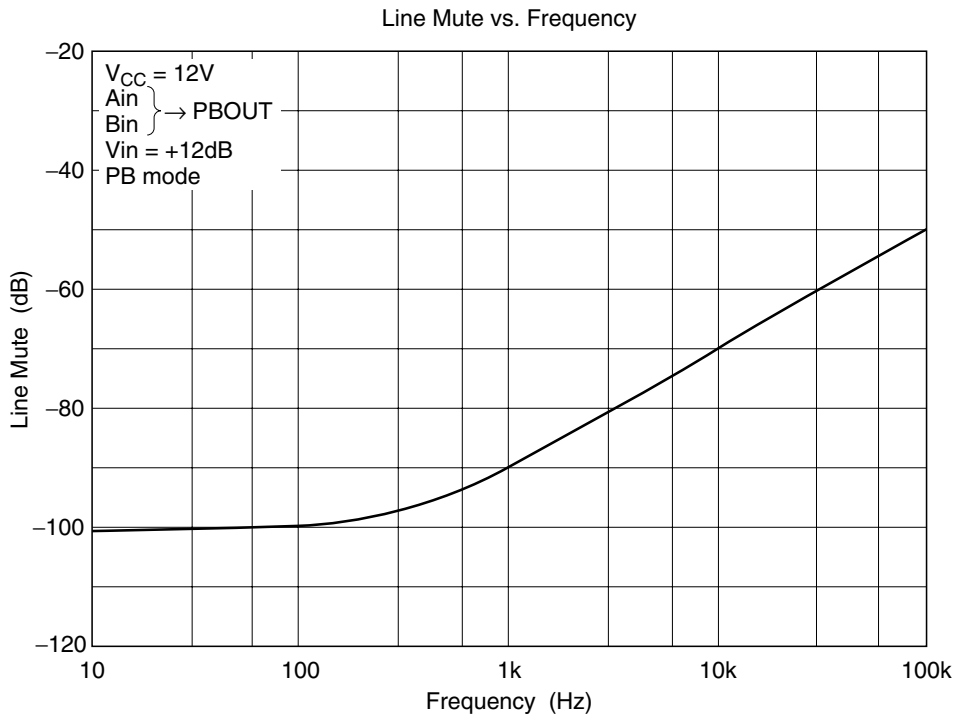

Ripple Rejection Ratio vs. Frequency (REC mode) (1)

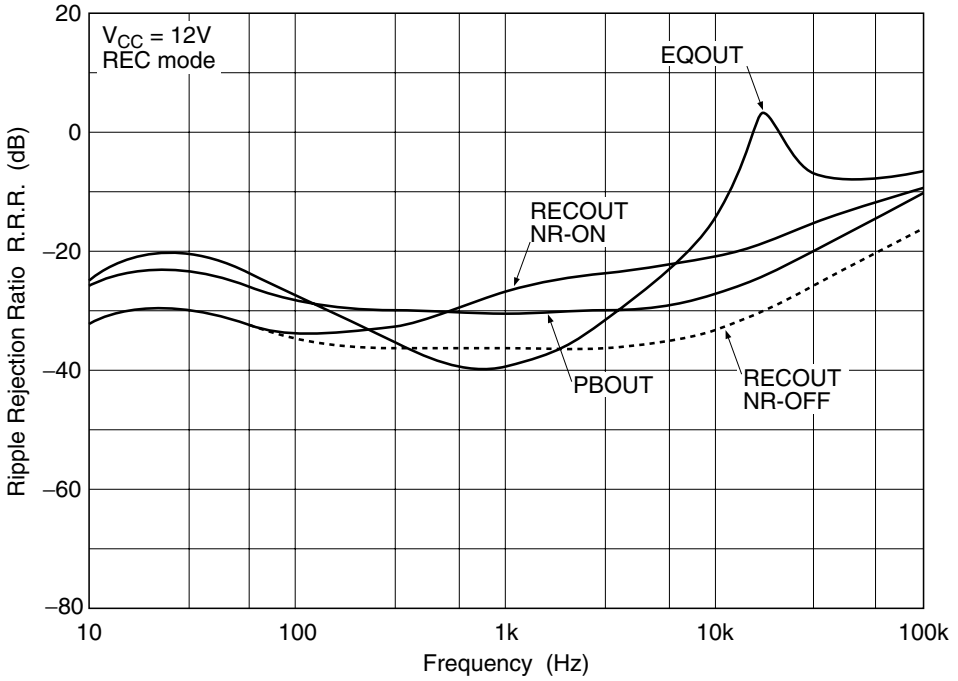

Ripple Rejection Ratio vs. Frequency (PB mode) (2)

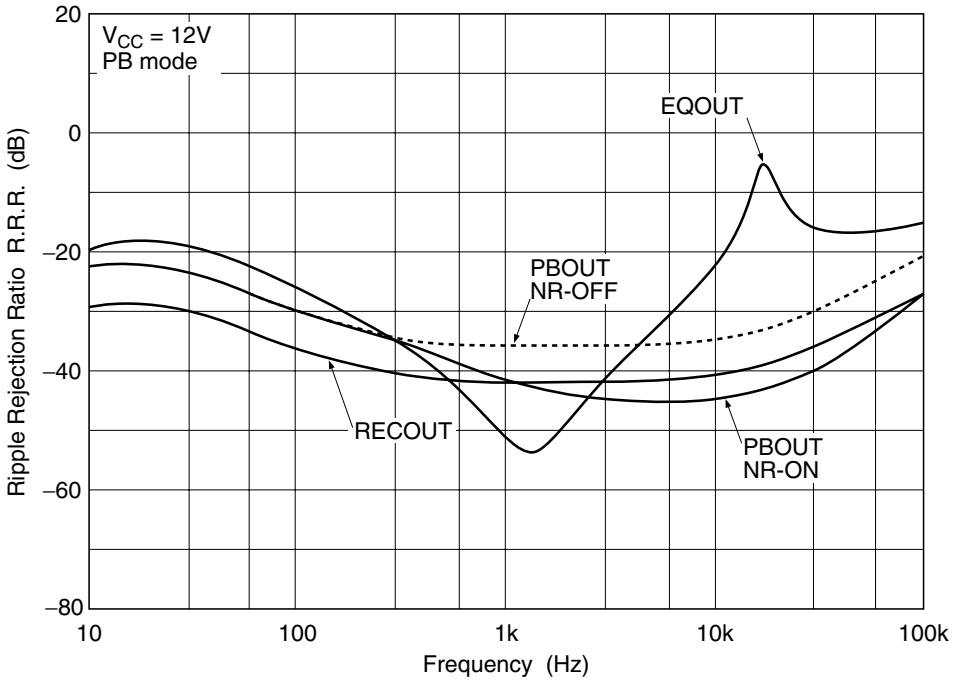

Ripple Rejection Ratio vs. Frequency (PASS mode) (3)

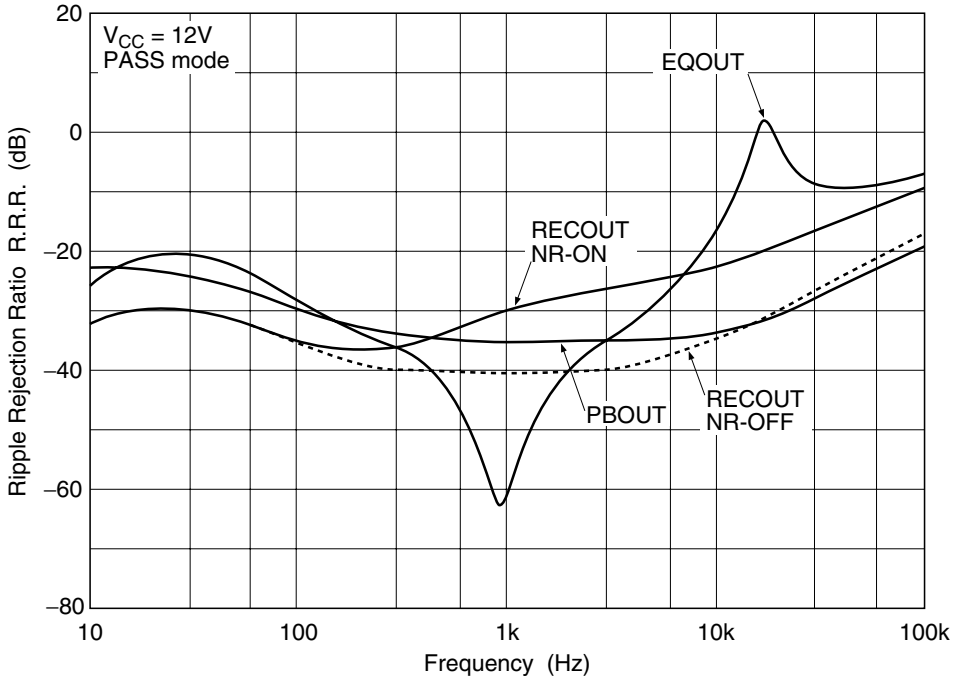

Equalizer Amp. Gain vs. Frequency (1)

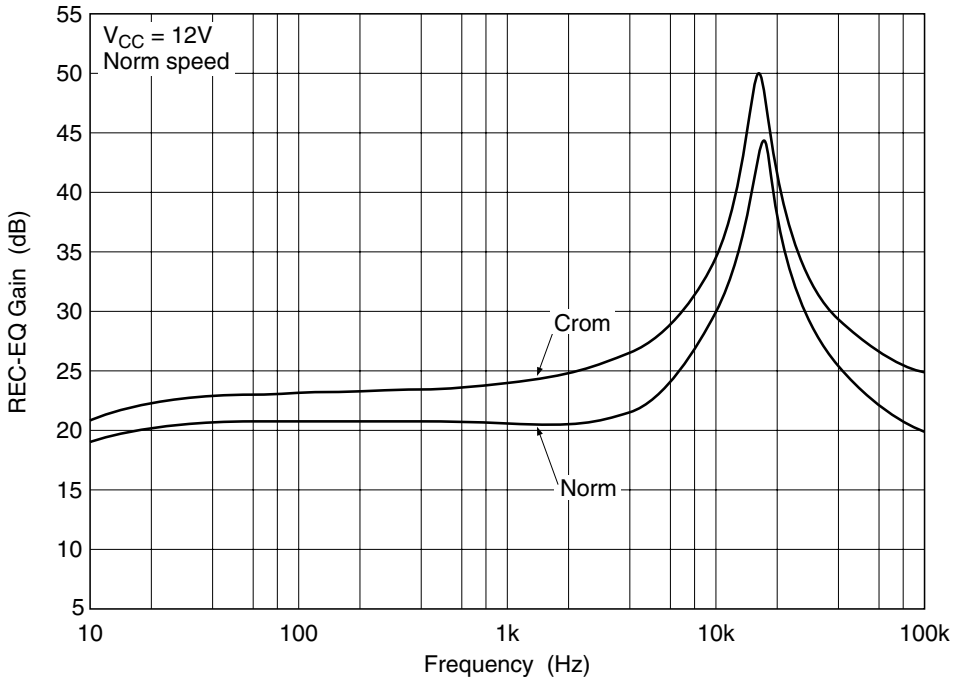

Equalizer Amp. Gain vs. Frequency (2)

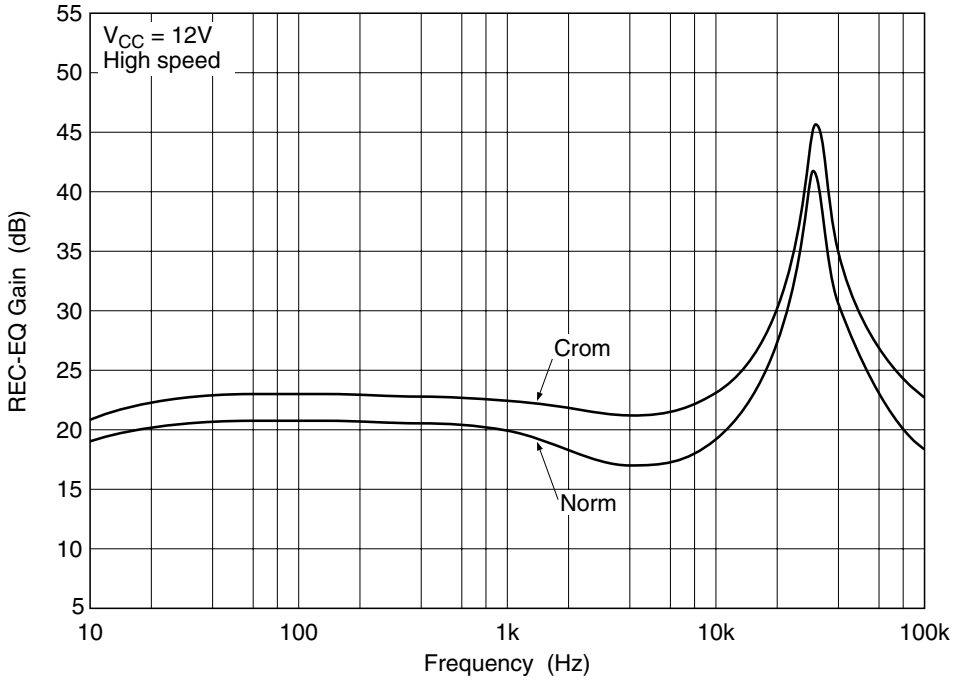

Equalizer Amp. Gain vs. Frequency (REC-cal)

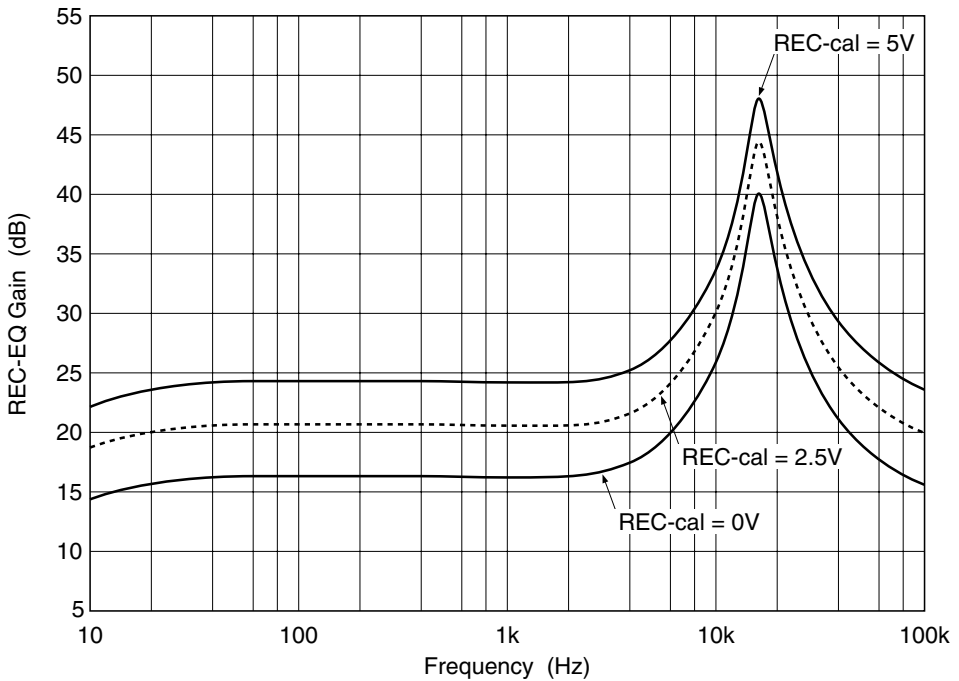

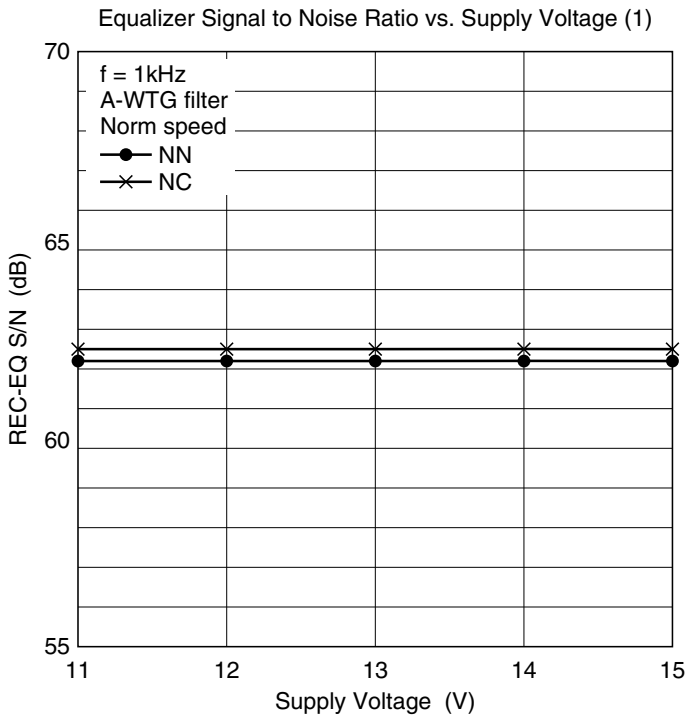
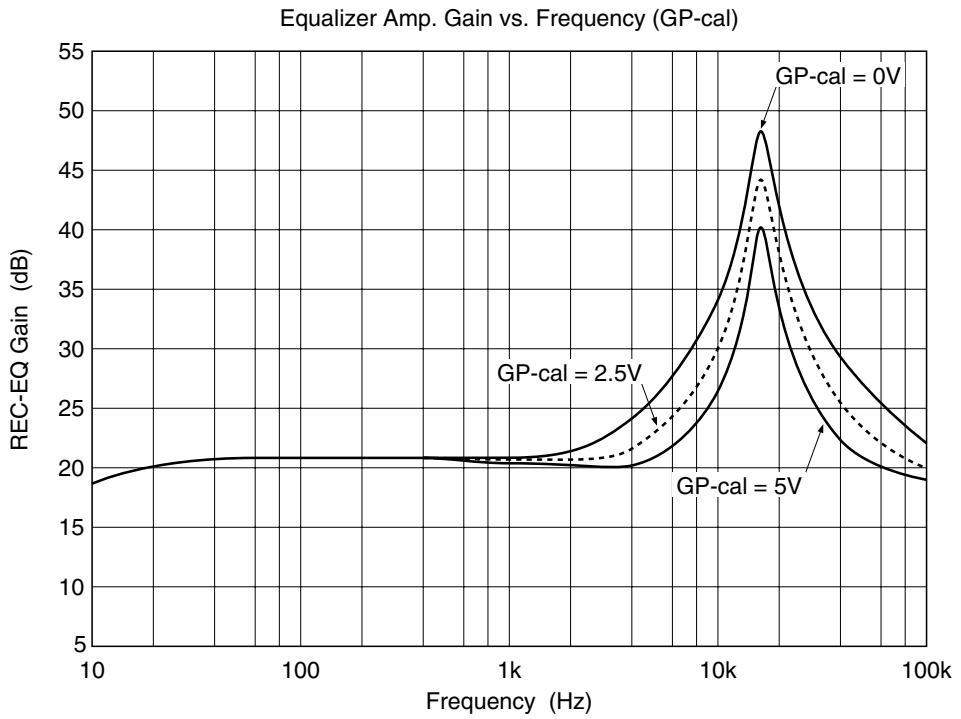

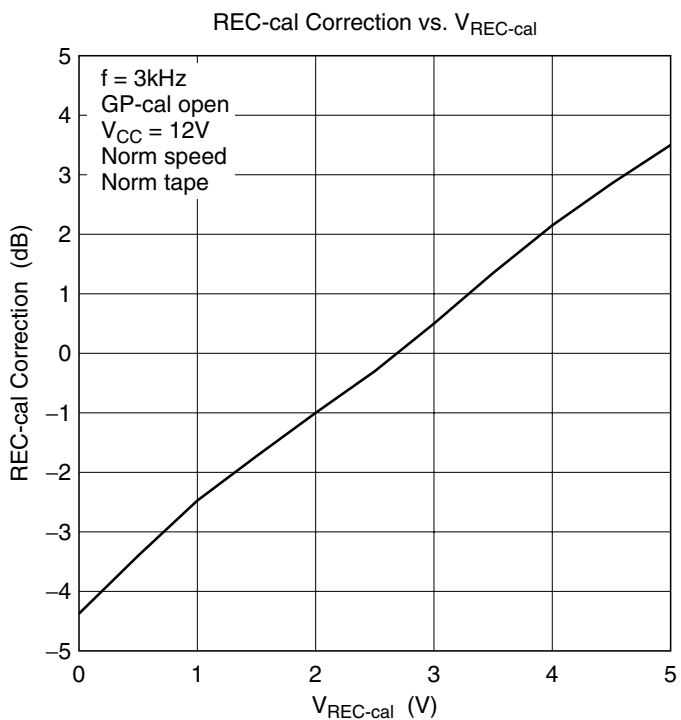
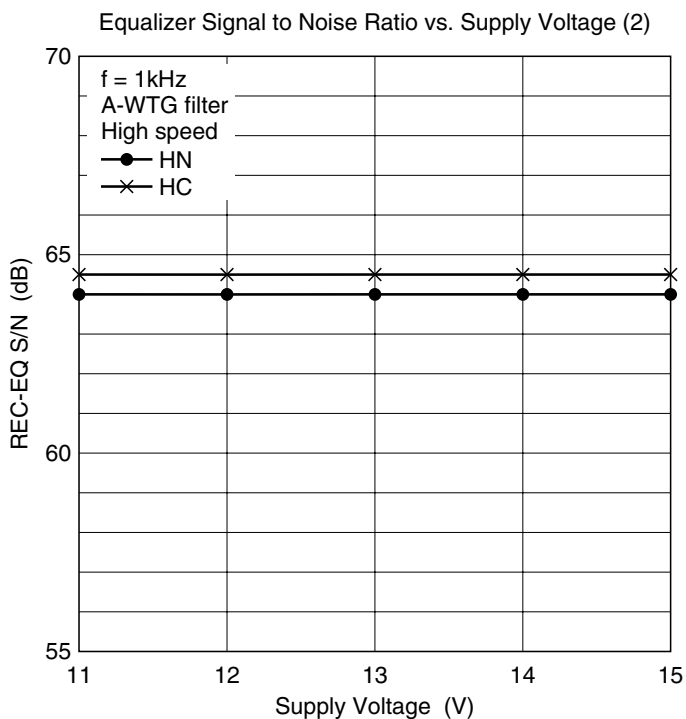

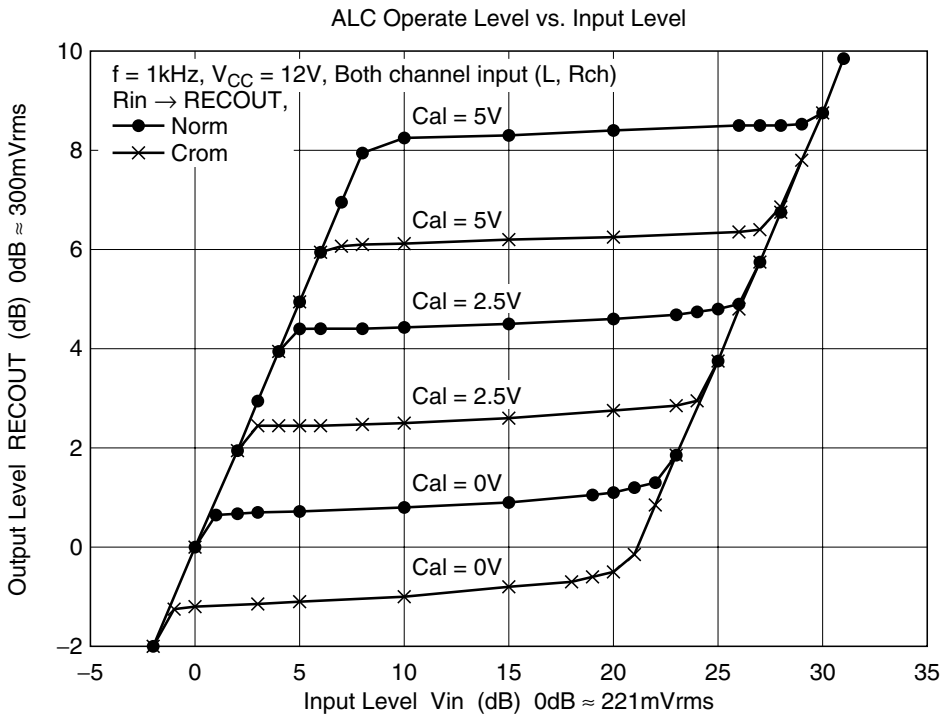
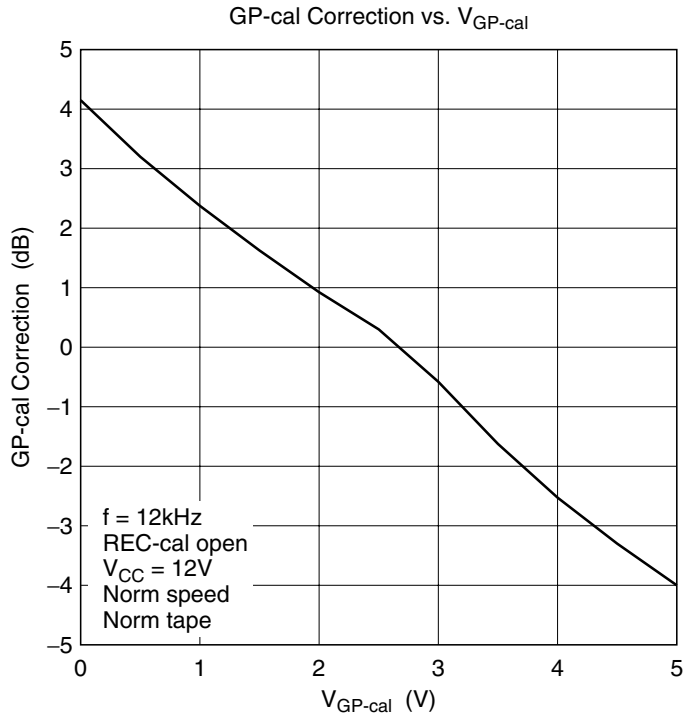

ALC Total Harmonic Distortion vs. Input Level (1)

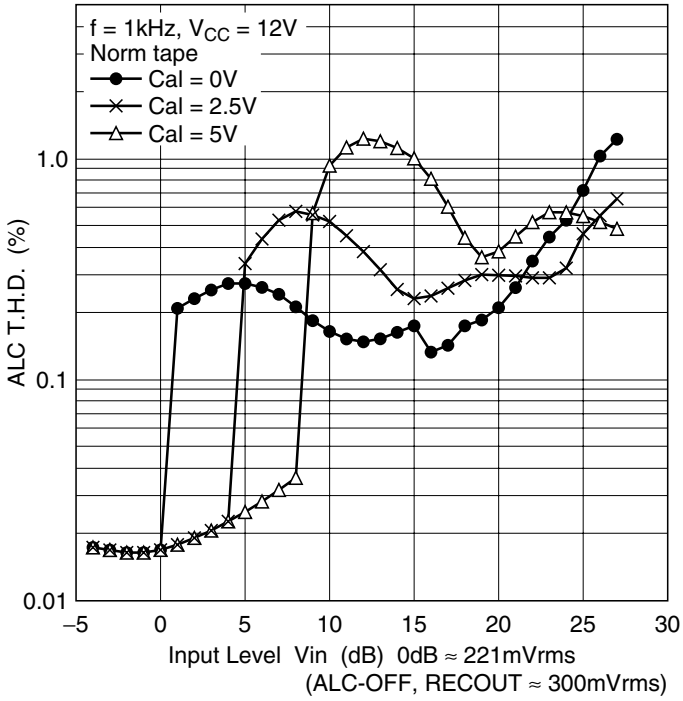

ALC Total Harmonic Distortion vs. Input Level (2)

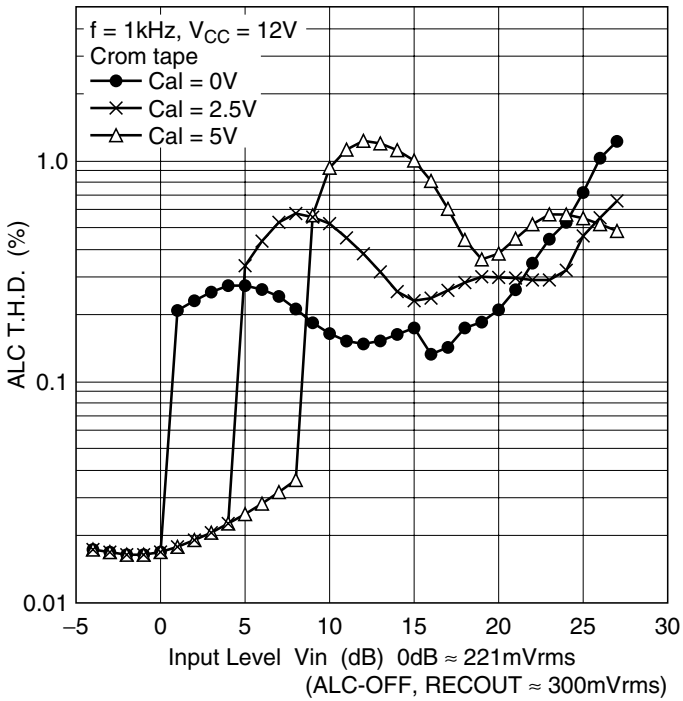

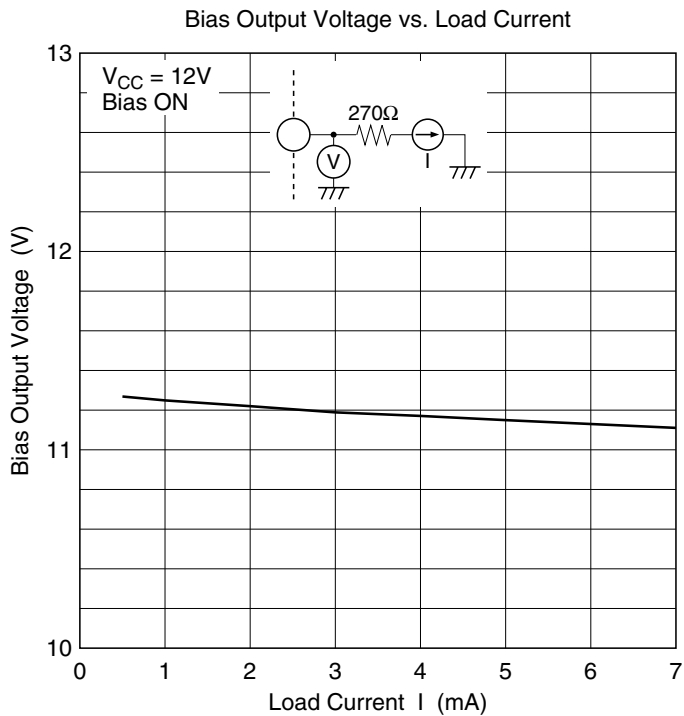
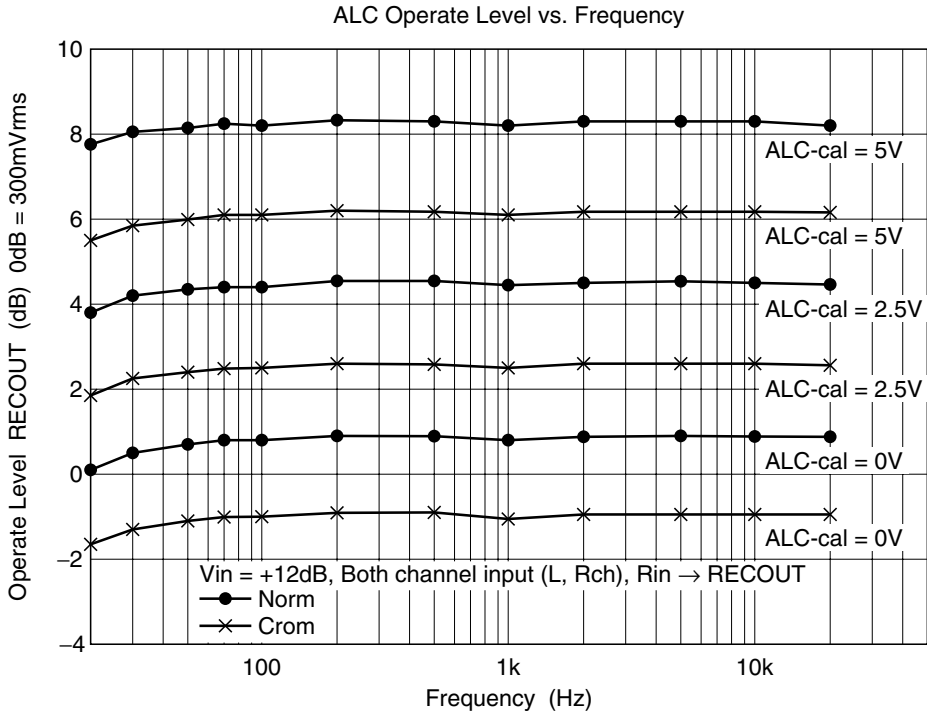

MS Sensing Level vs. Frequency

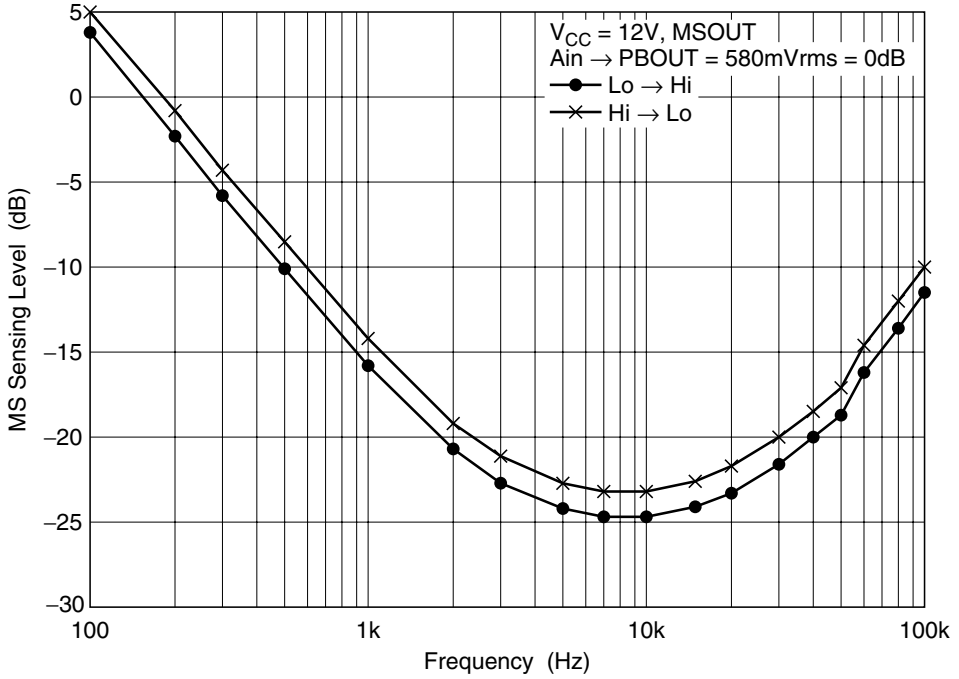

MS Amp. Gain vs. Frequency

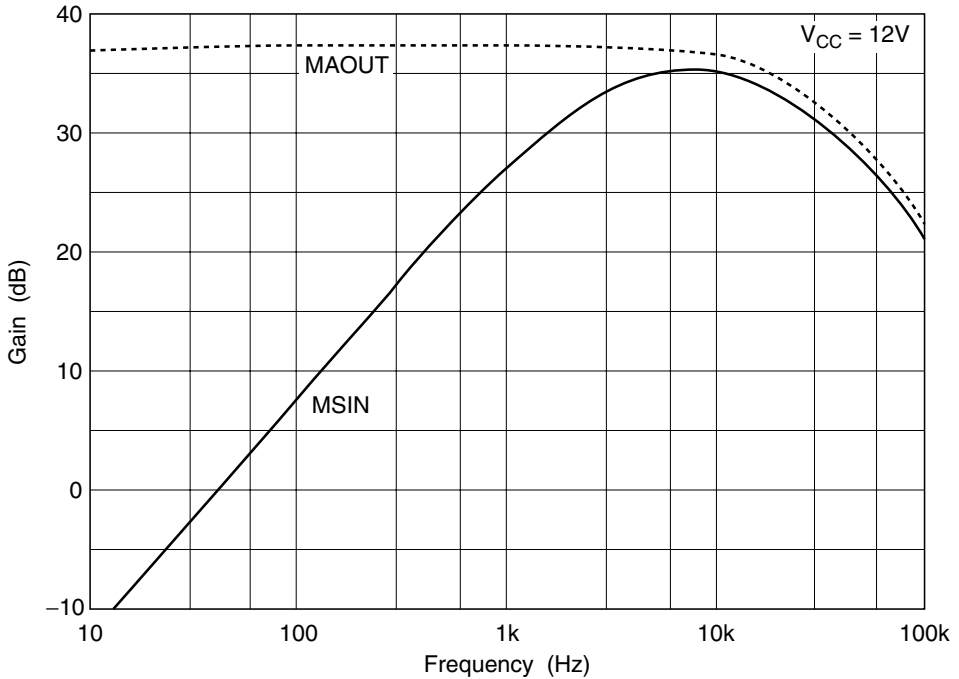

No-Signal Sensing Time vs. Resistance

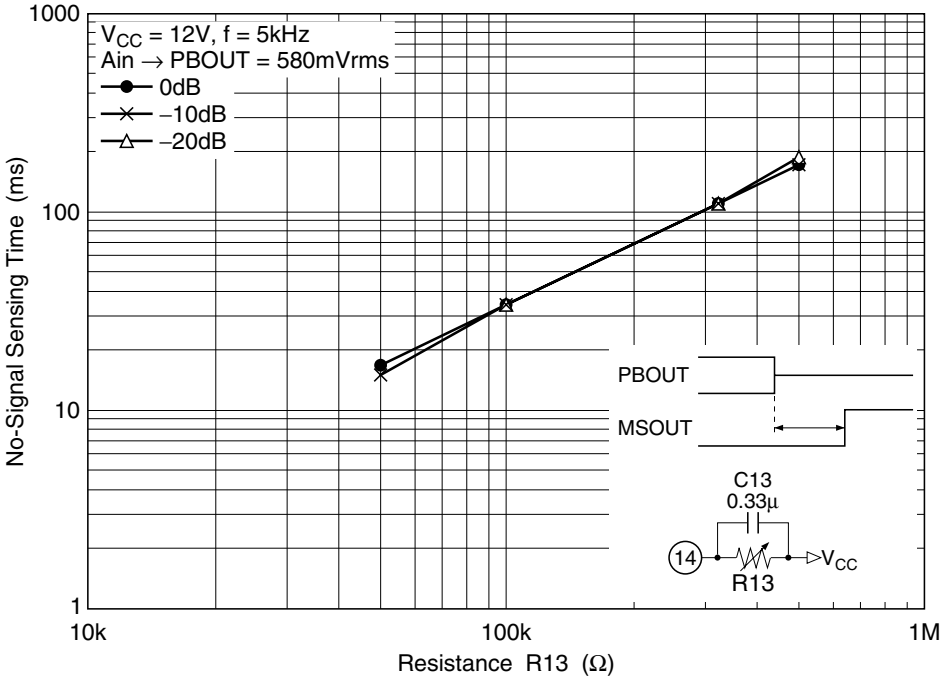

Signal Sensing Time vs. Capacitance

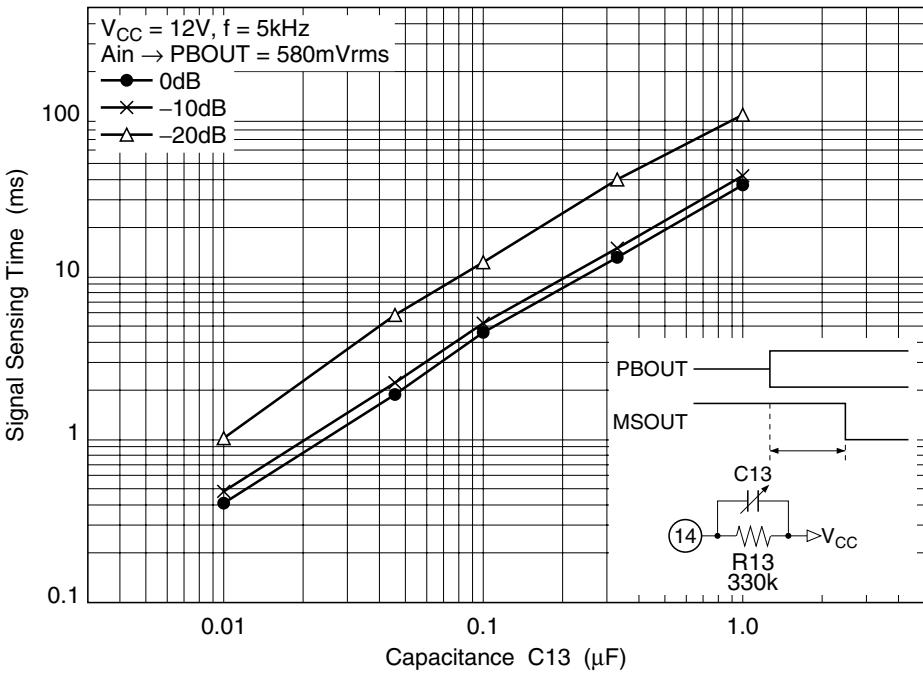

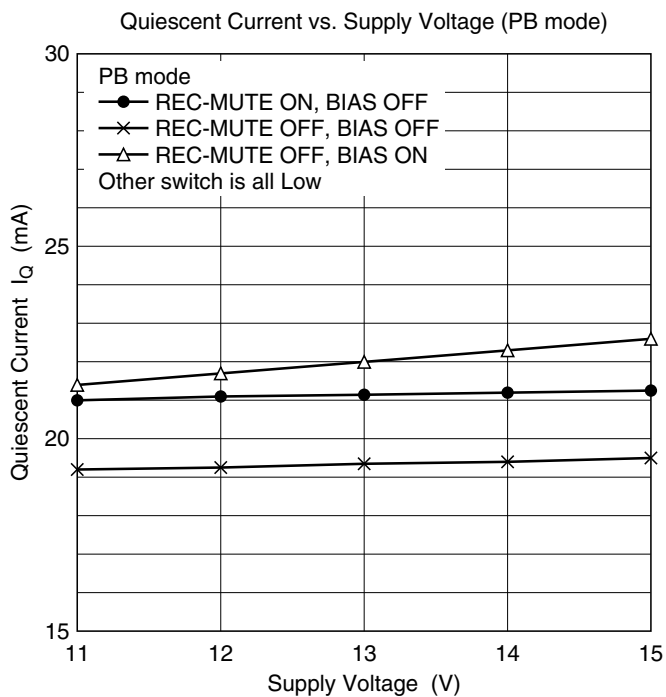
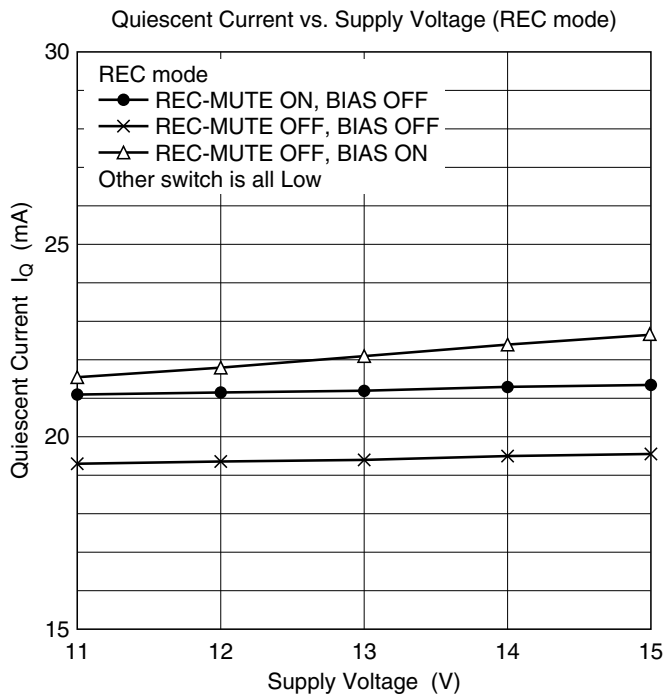

Input Amp. Gain vs. Frequency (1)

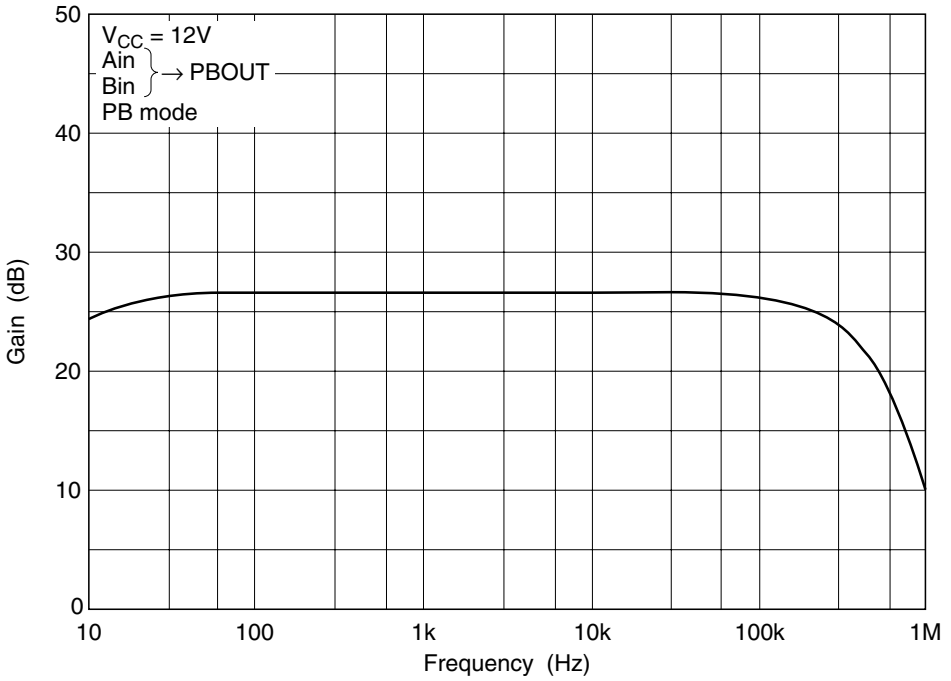

Input Amp. Gain vs. Frequency (2)

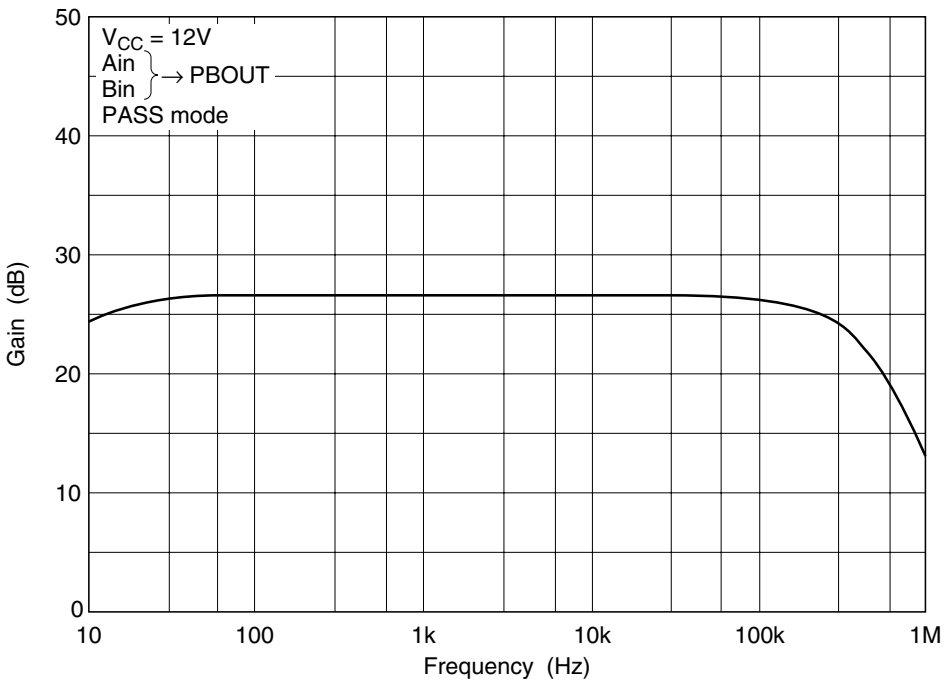

Input Amp. Gain vs. Frequency (3)

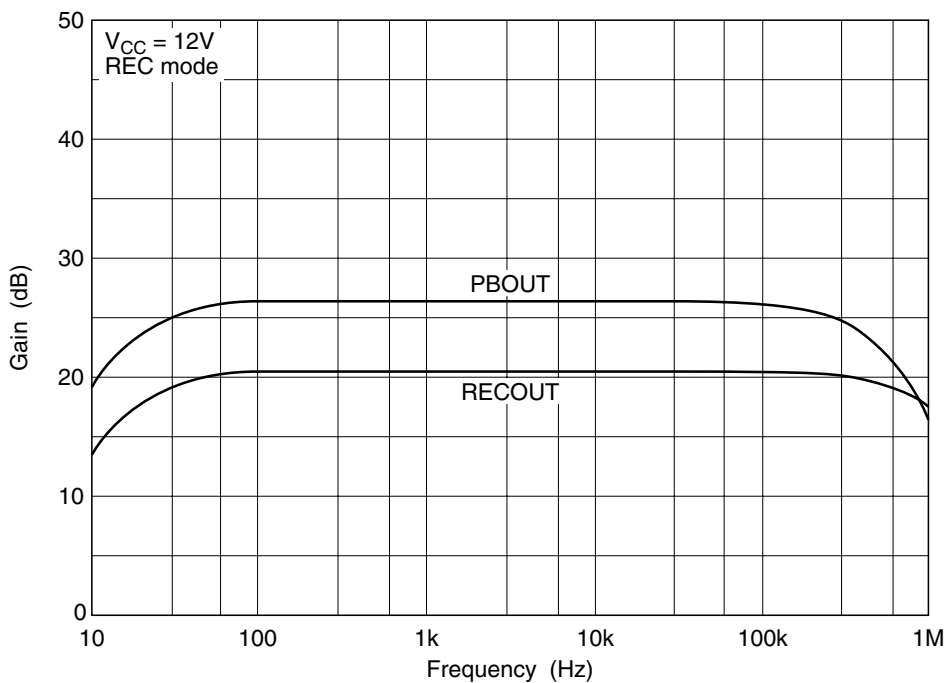

Input Amp. Gain vs. Frequency (4)

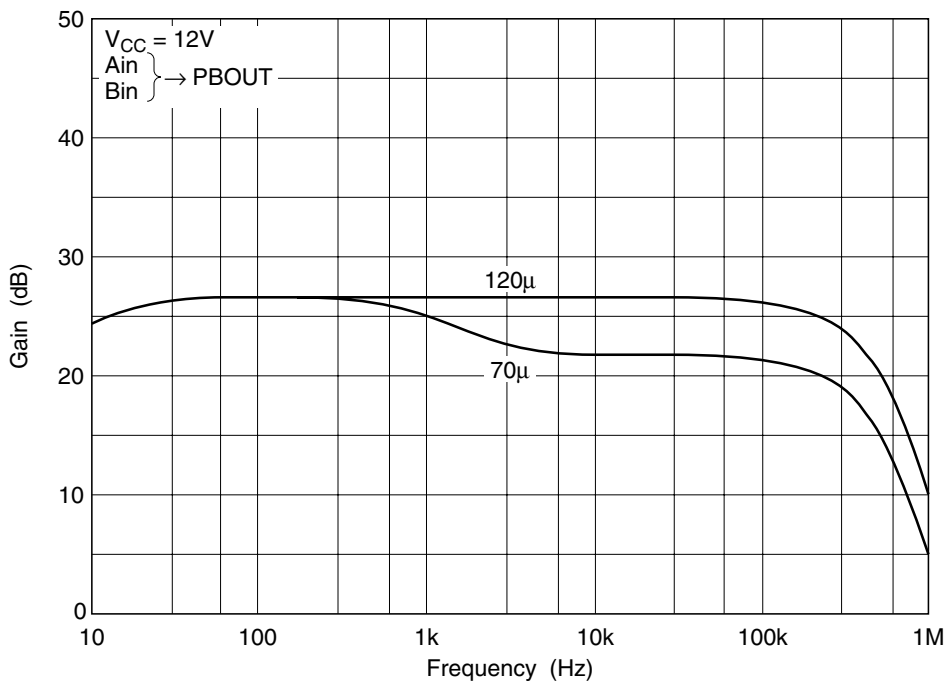

Signal Handling (1)

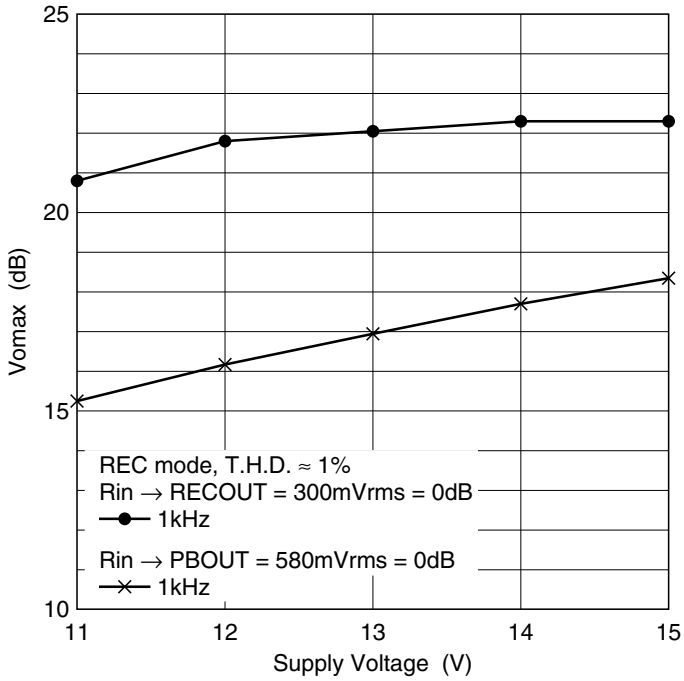

Signal Handling (2)

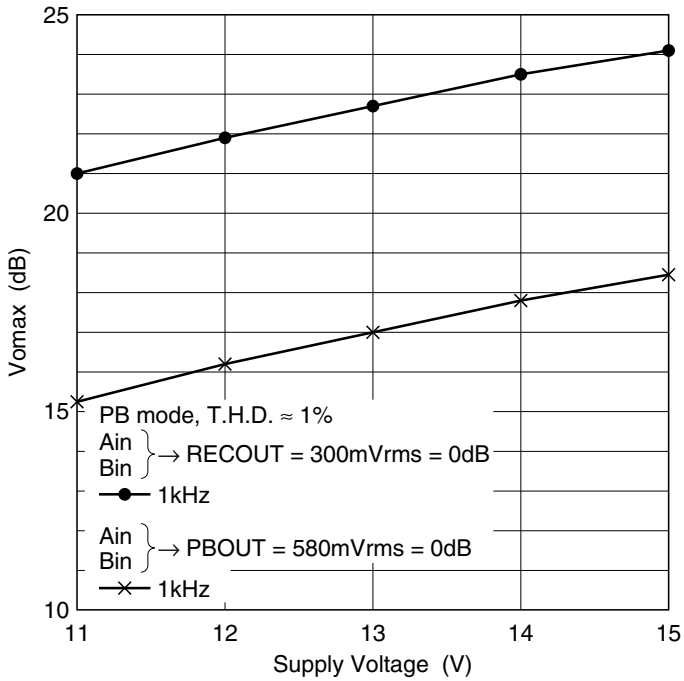

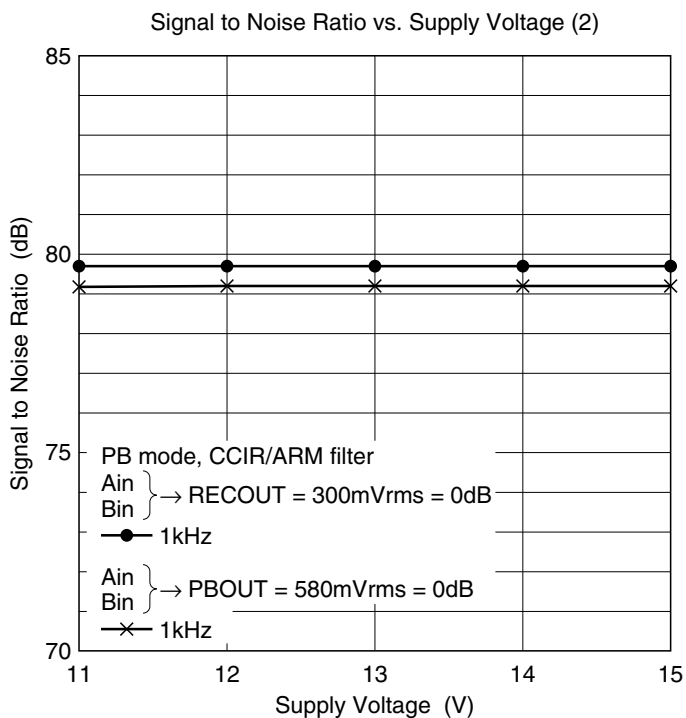
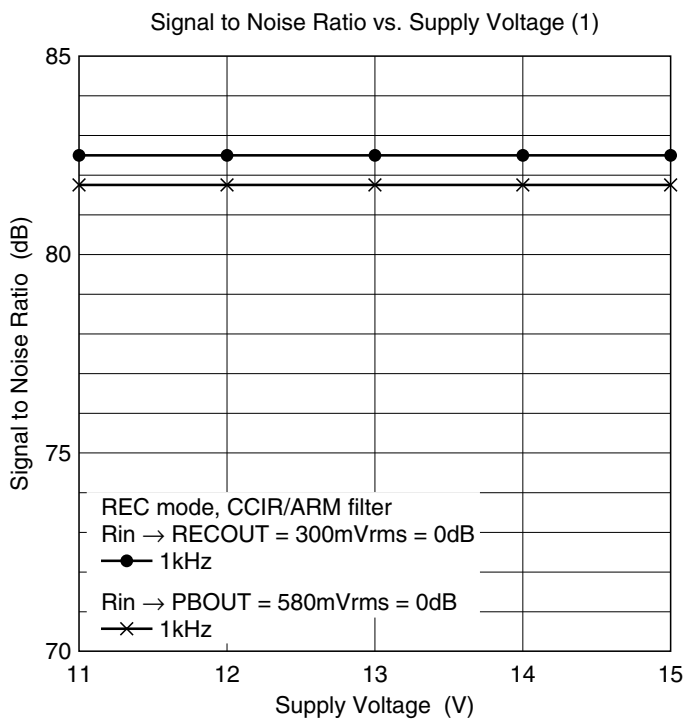

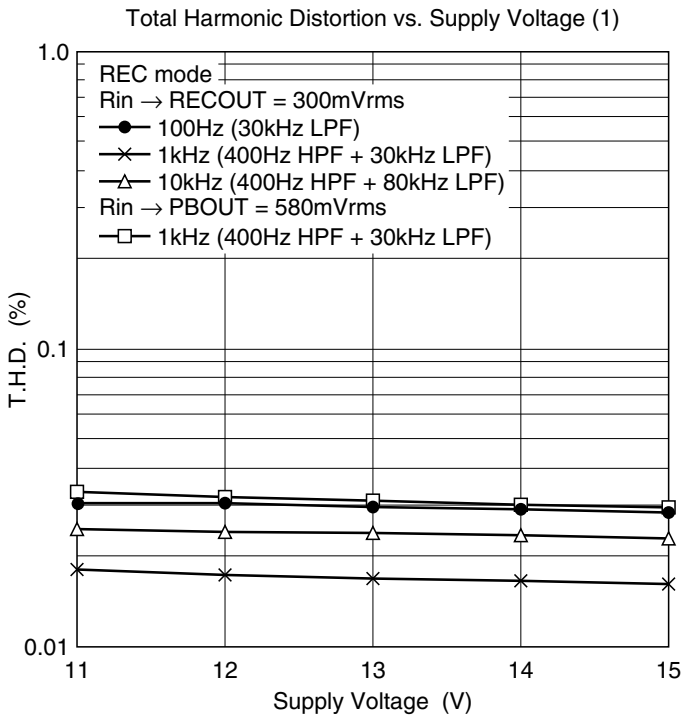
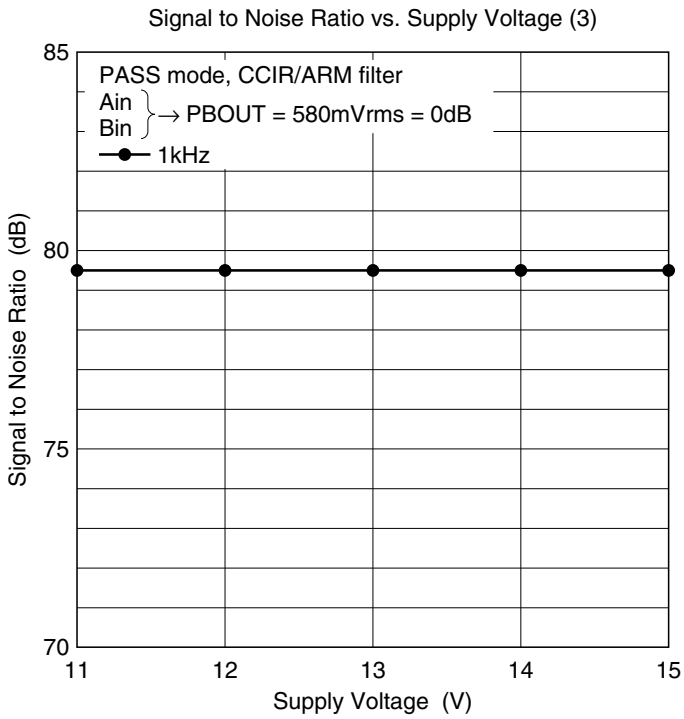

Total Harmonic Distortion vs. Supply Voltage (2)

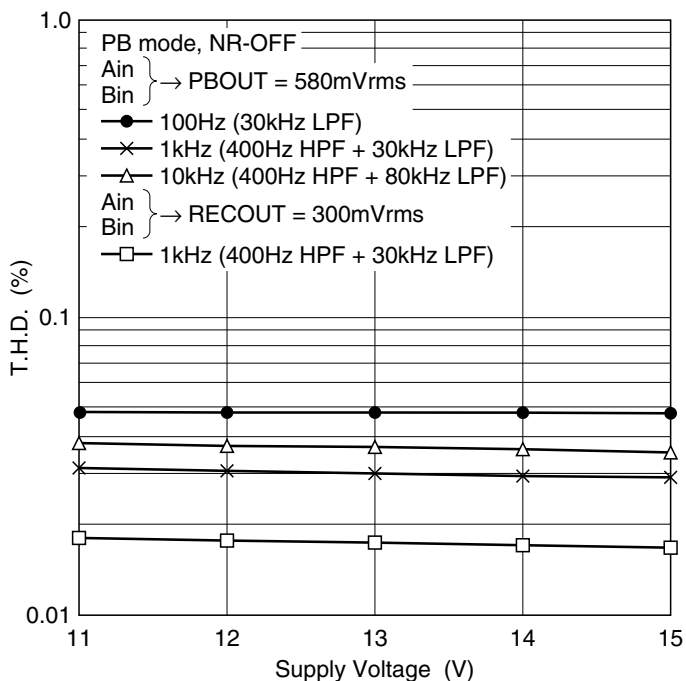

Total Harmonic Distortion vs. Supply Voltage (3)

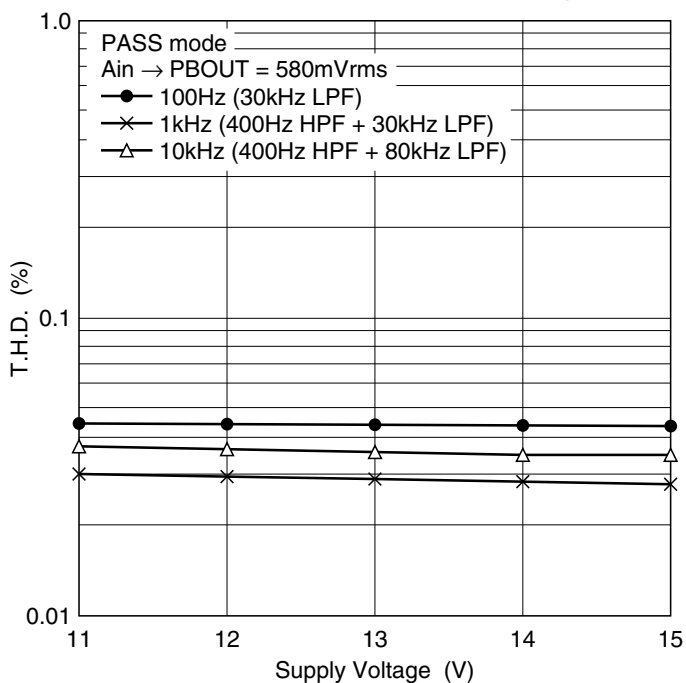

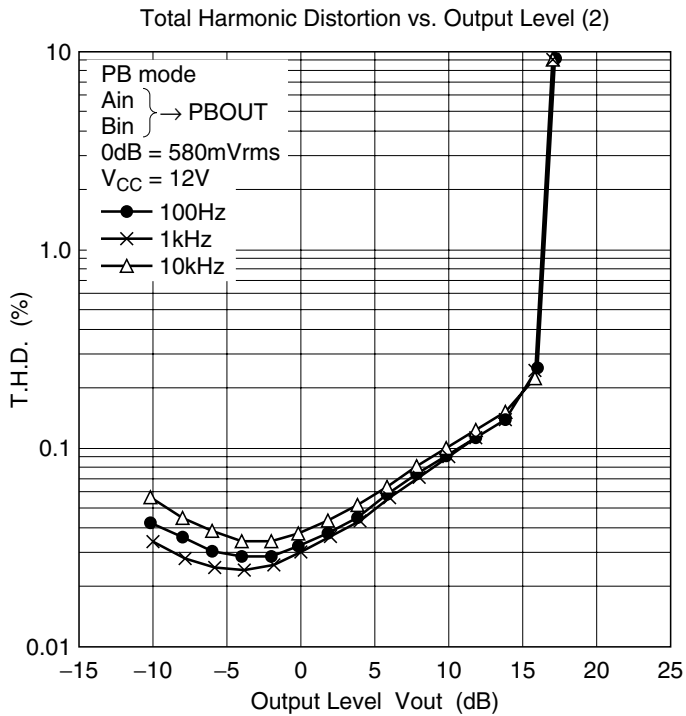
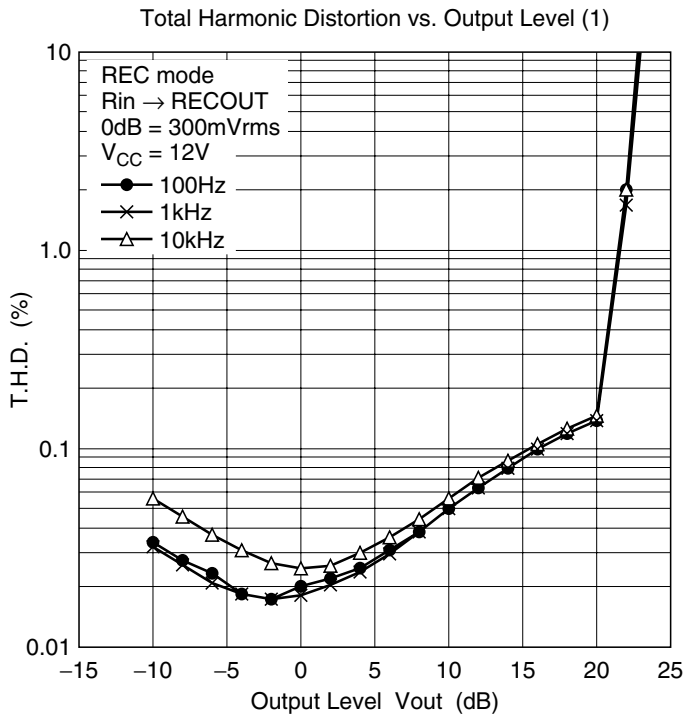

Total Harmonic Distortion vs. Output Level (3)

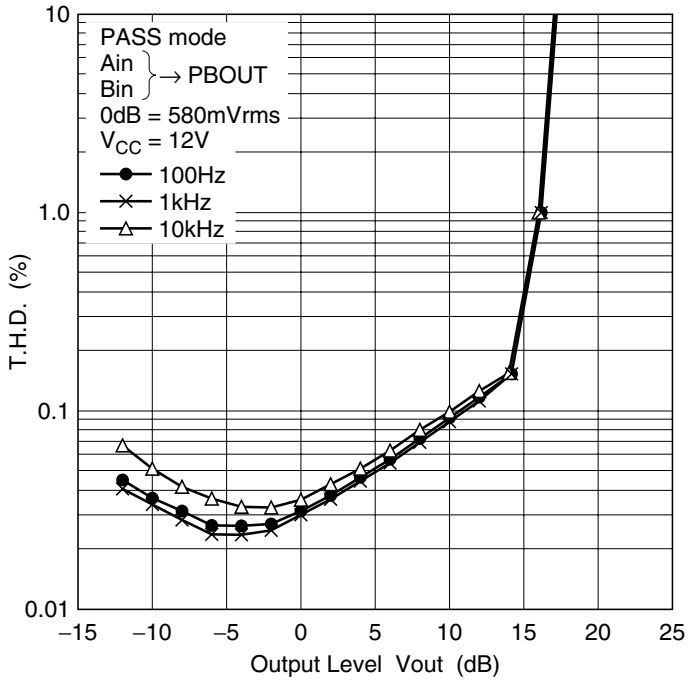

Total Harmonic Distortion vs. Frequency (1)

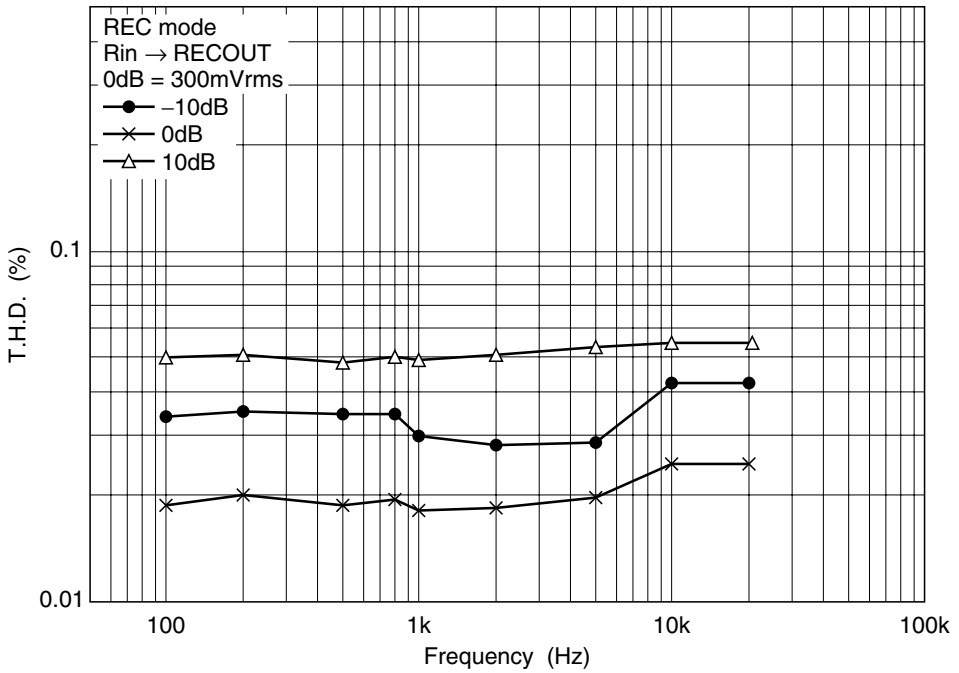

Total Harmonic Distortion vs. Frequency (2)

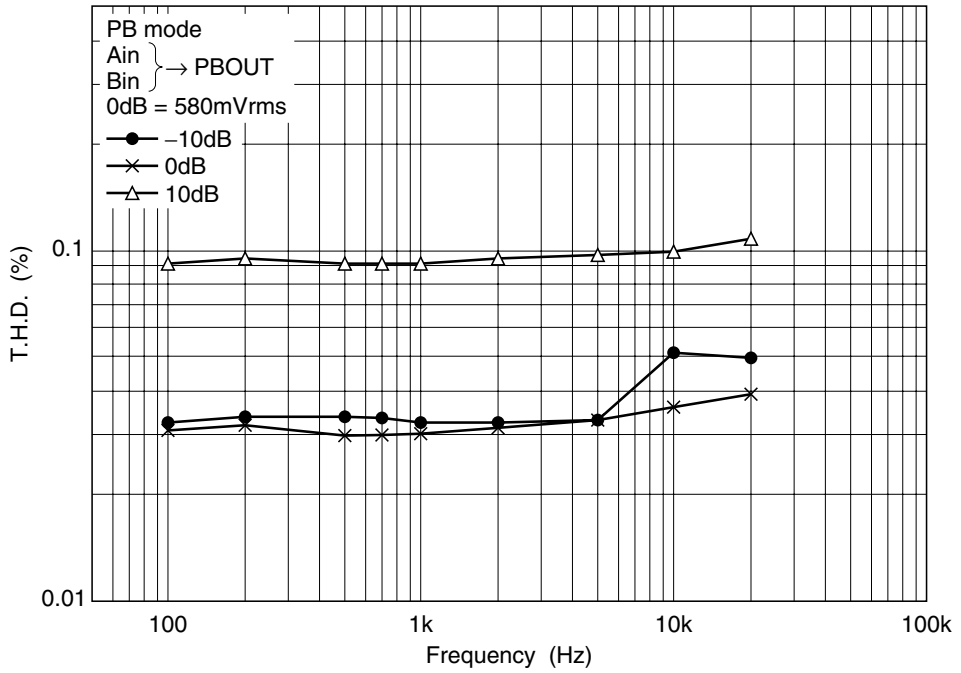

Total Harmonic Distortion vs. Frequency (3)

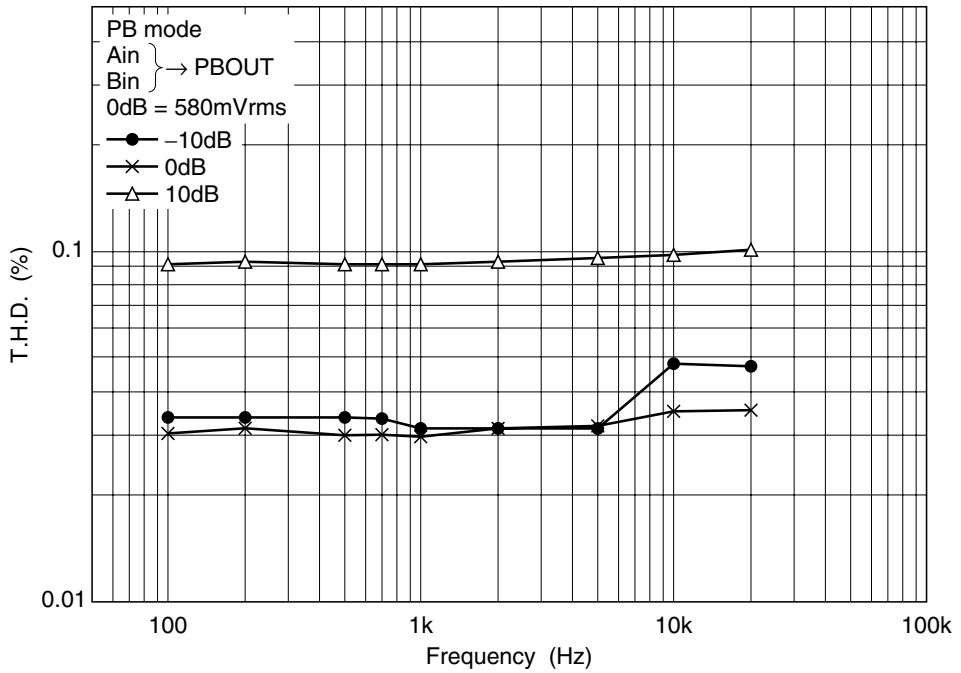

Channel Separation vs. Frequency (R → L) (1)

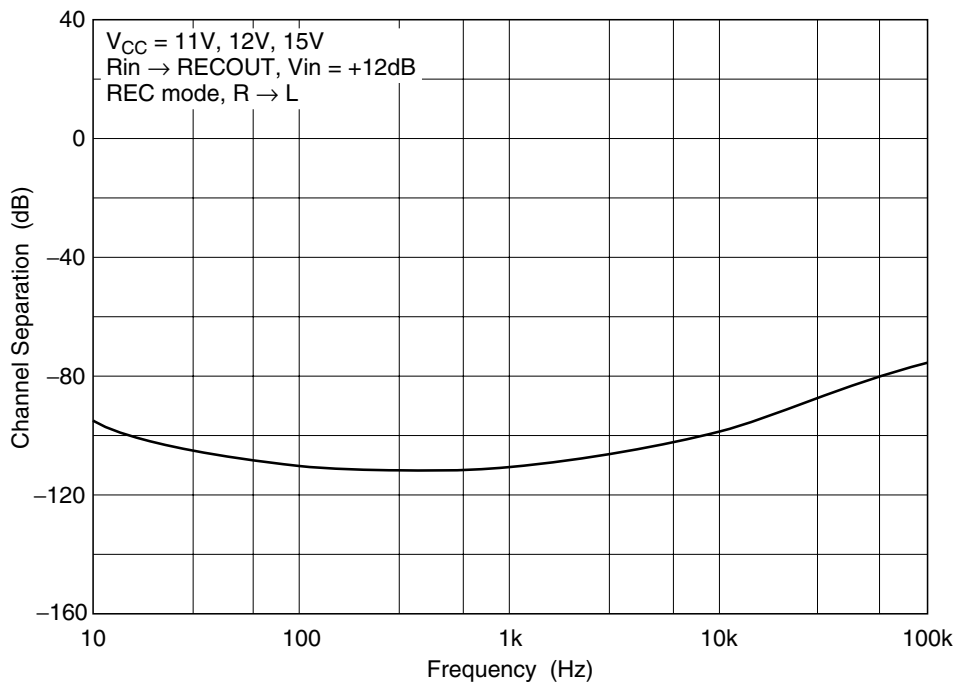

Channel Separation vs. Frequency (L → R) (2)

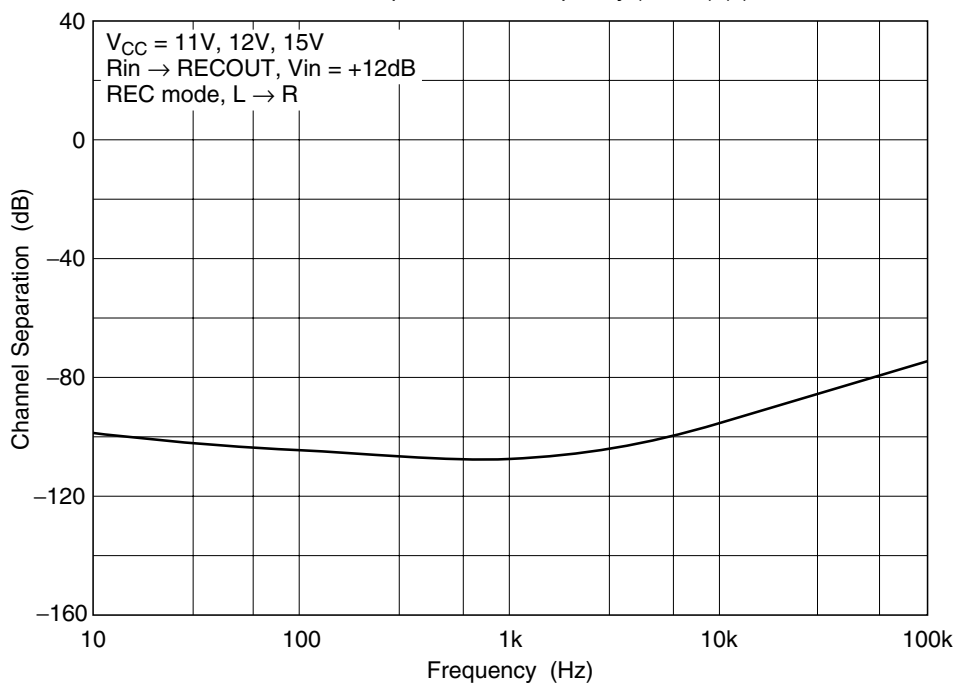

Channel Separation vs. Frequency (R → L) (3)

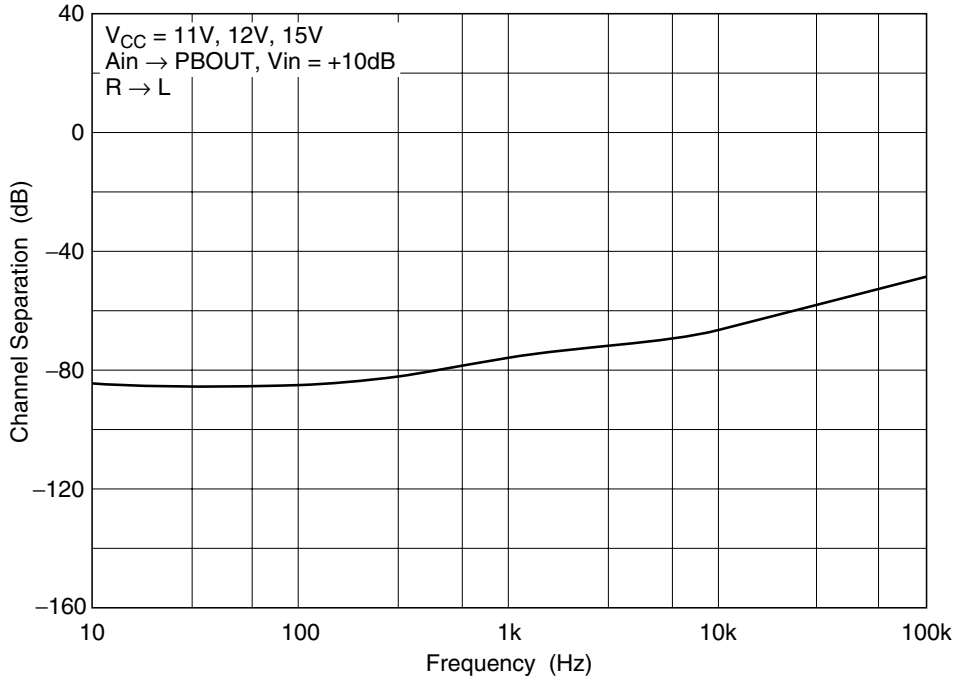

Channel Separation vs. Frequency (L → R) (4)

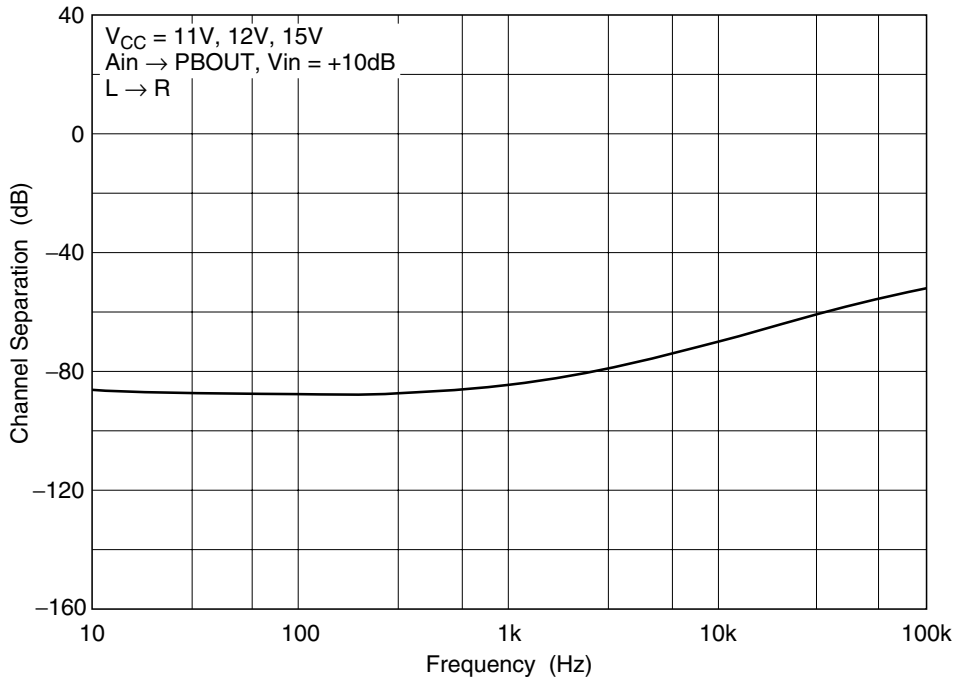

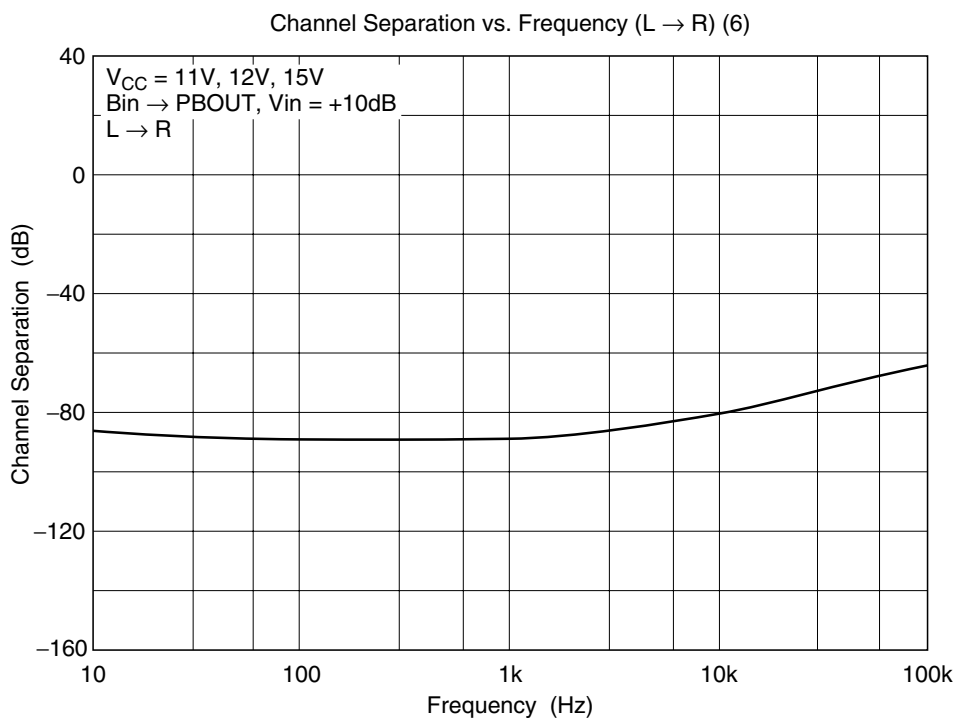
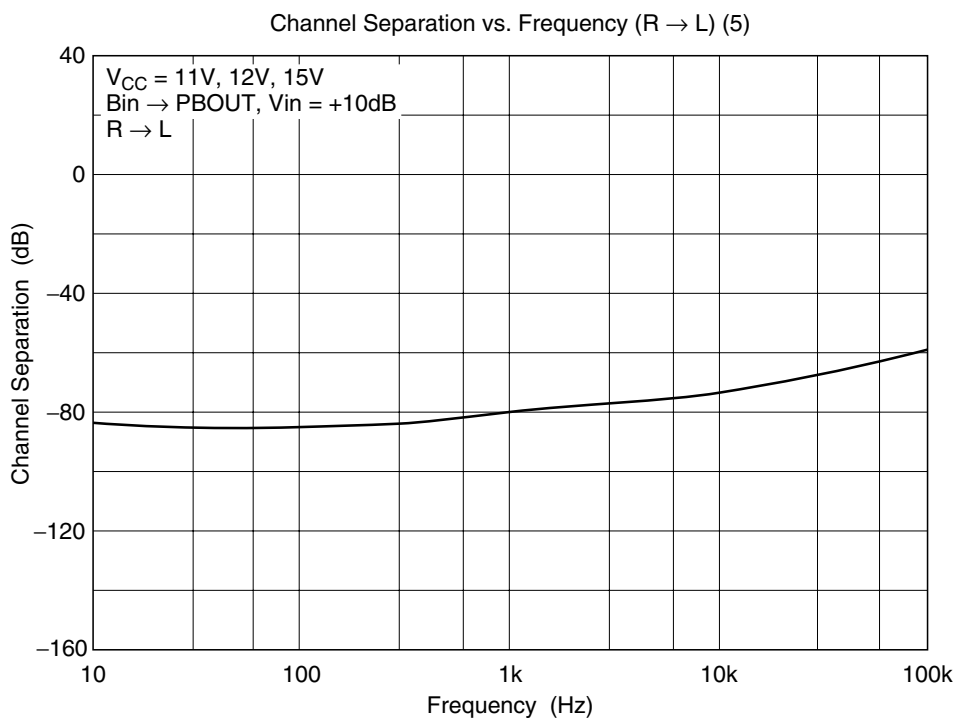

Channel Separation vs. Frequency (R → L) (7)

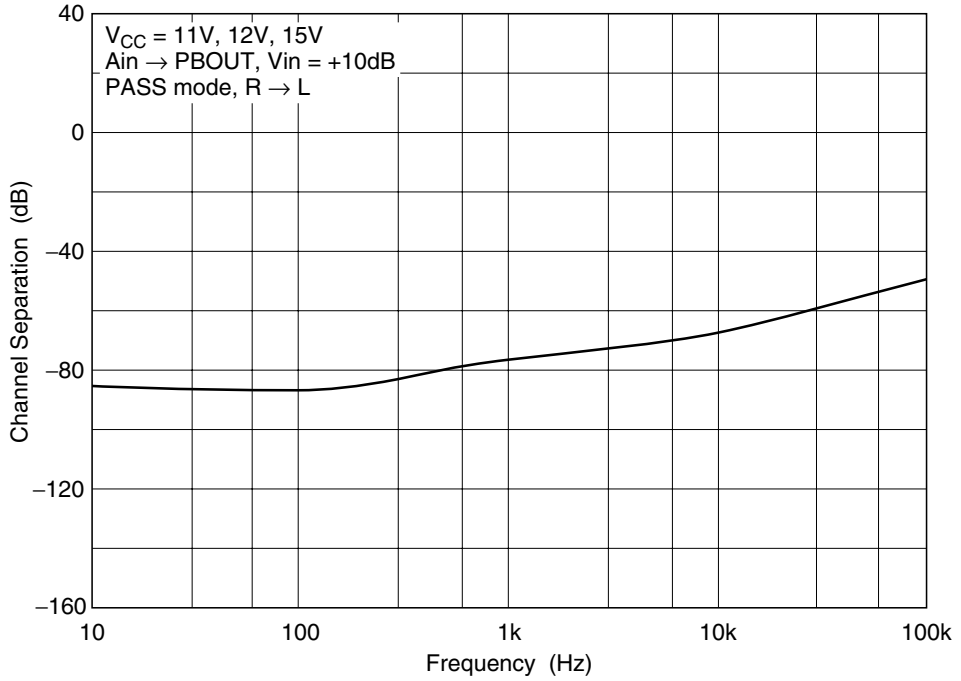

Channel Separation vs. Frequency (L → R) (8)

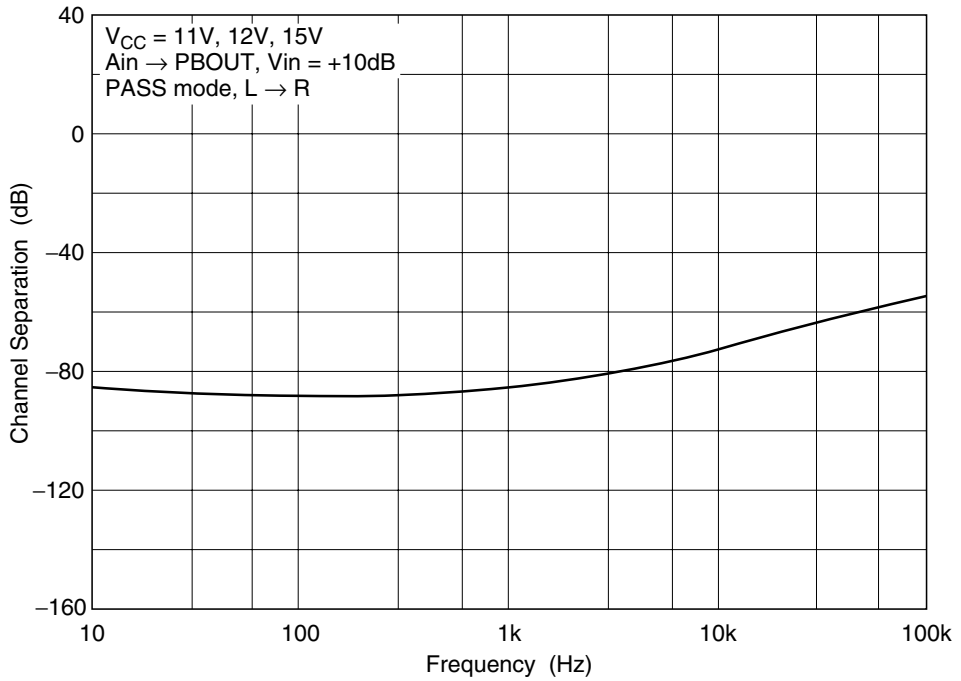

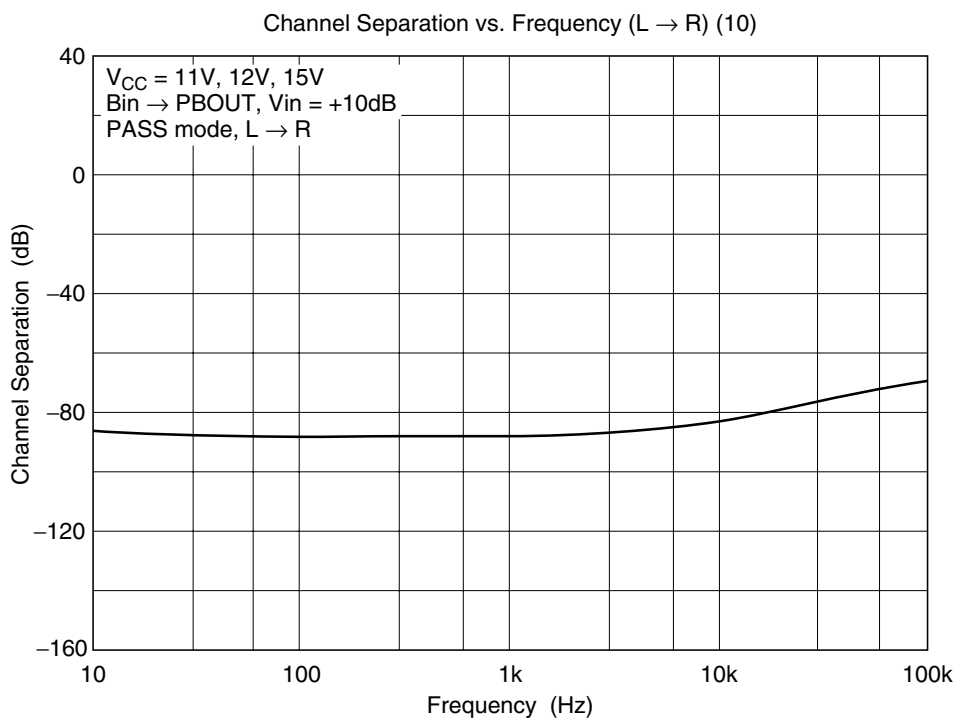
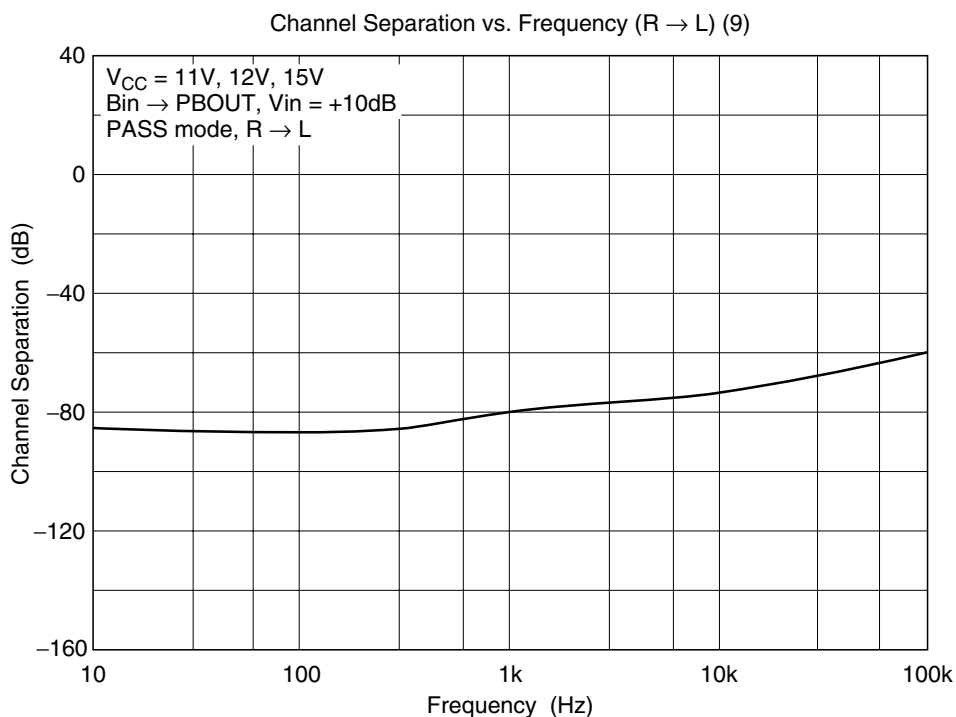

Crosstalk vs. Frequency (Ain → Bin) (1)

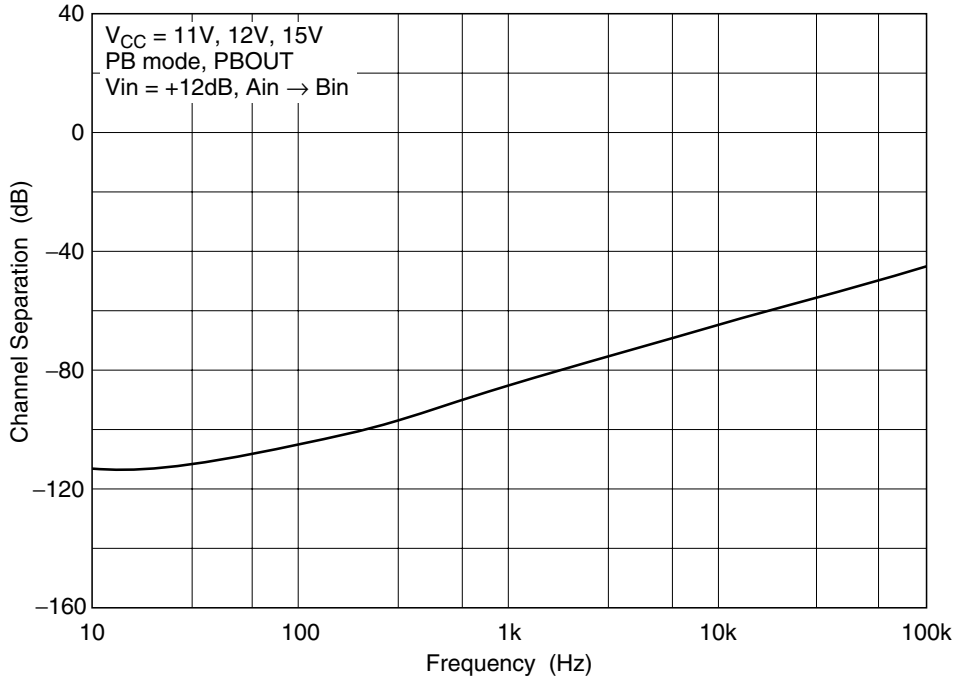

Crosstalk vs. Frequency (Bin → Ain) (2)

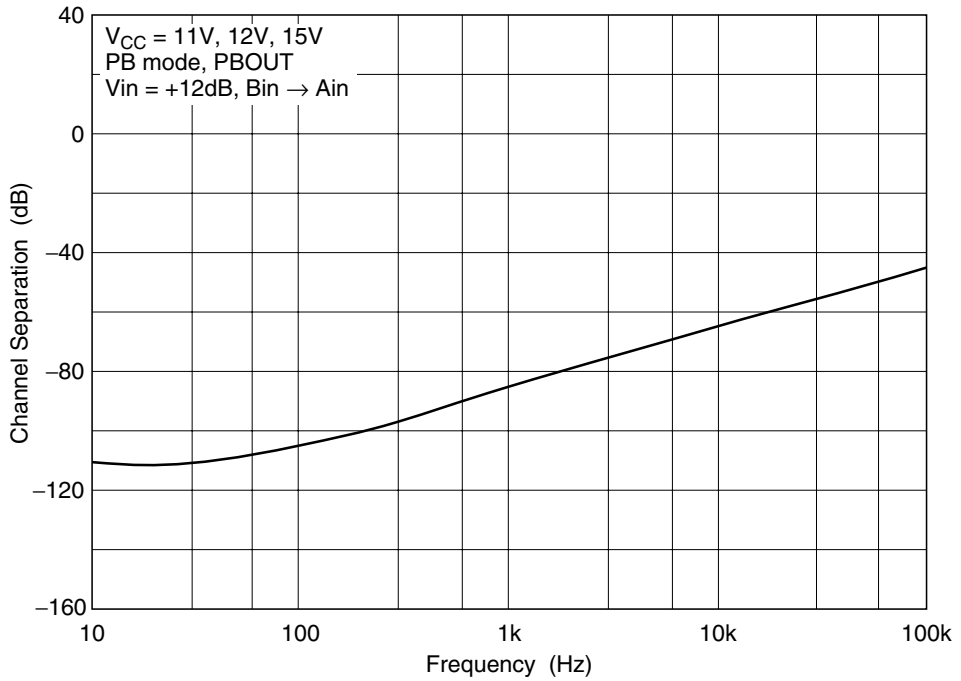

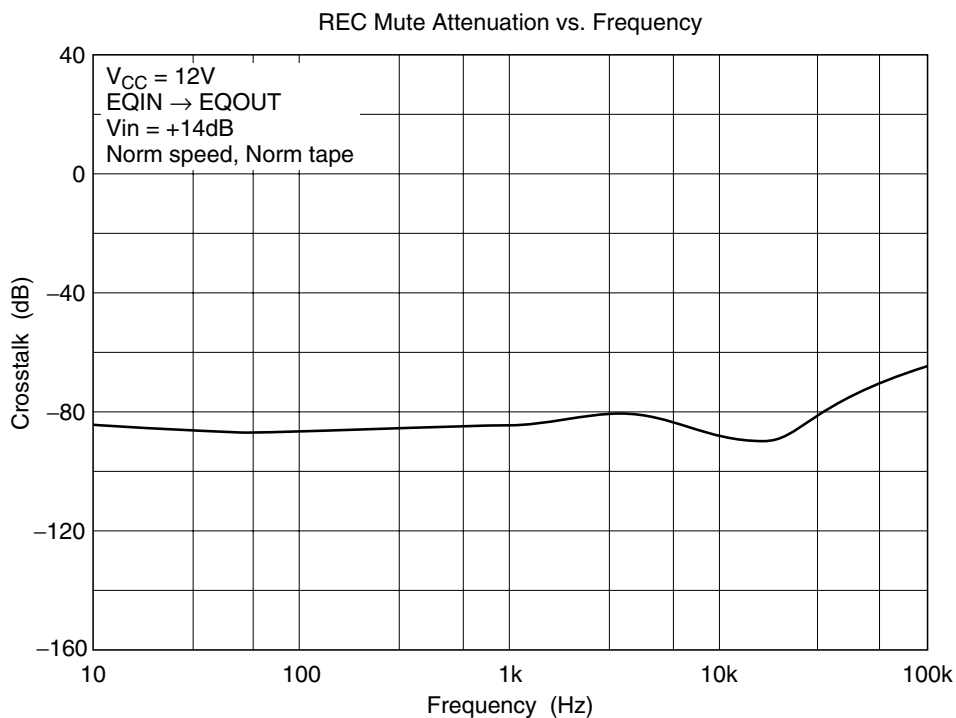
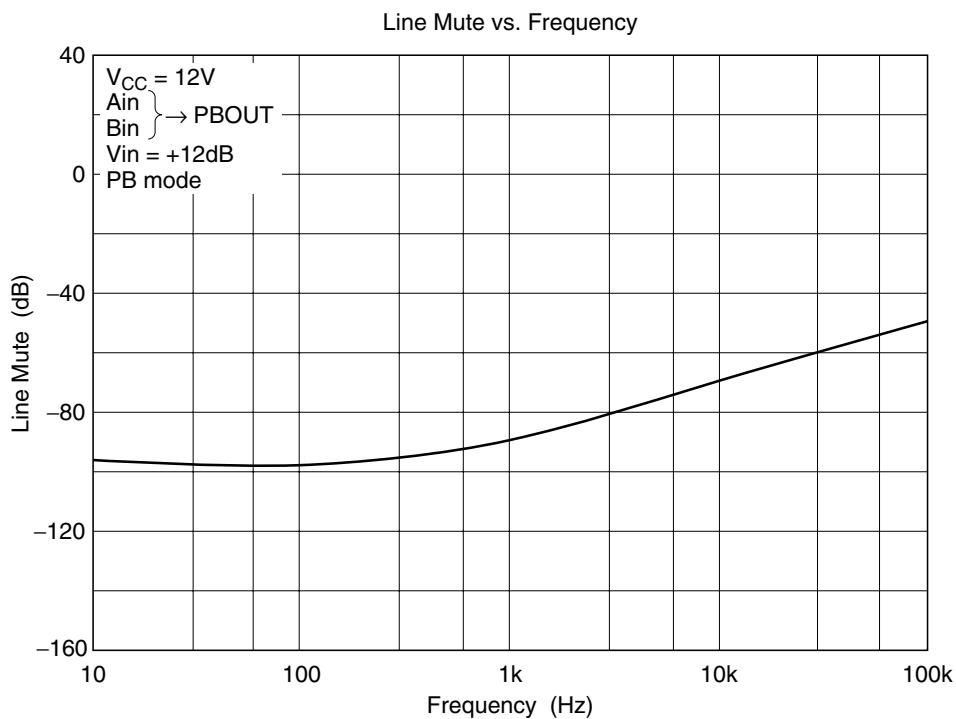

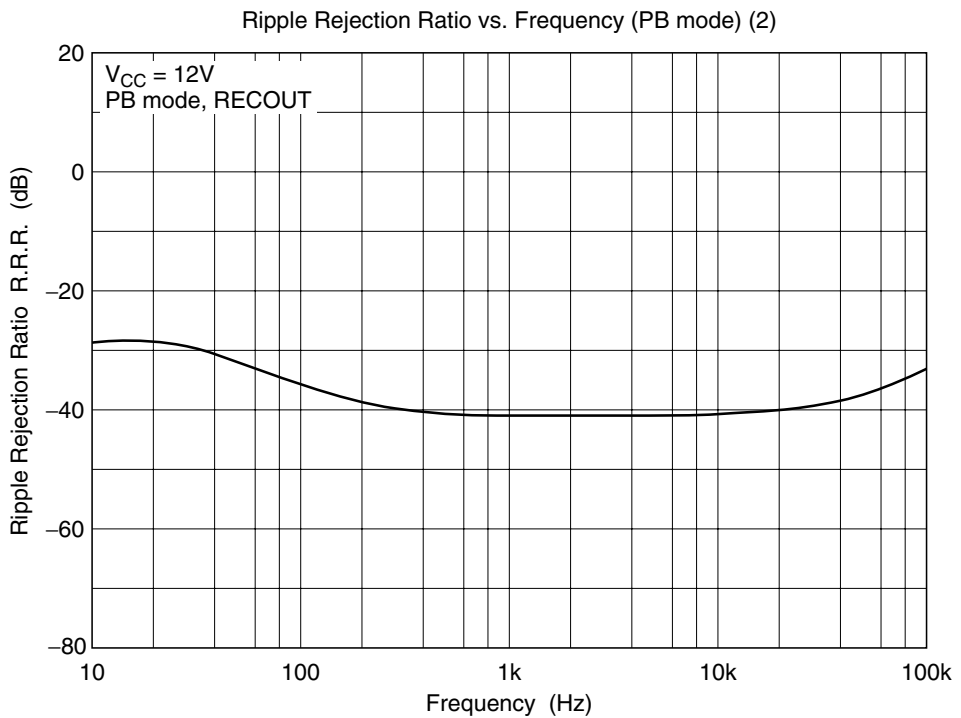
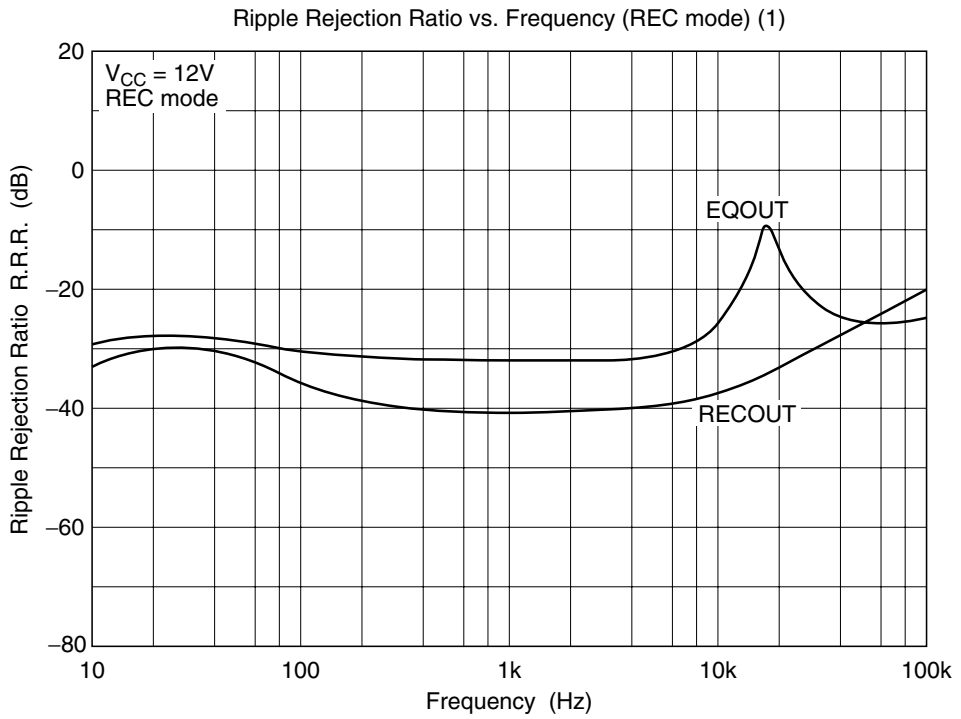

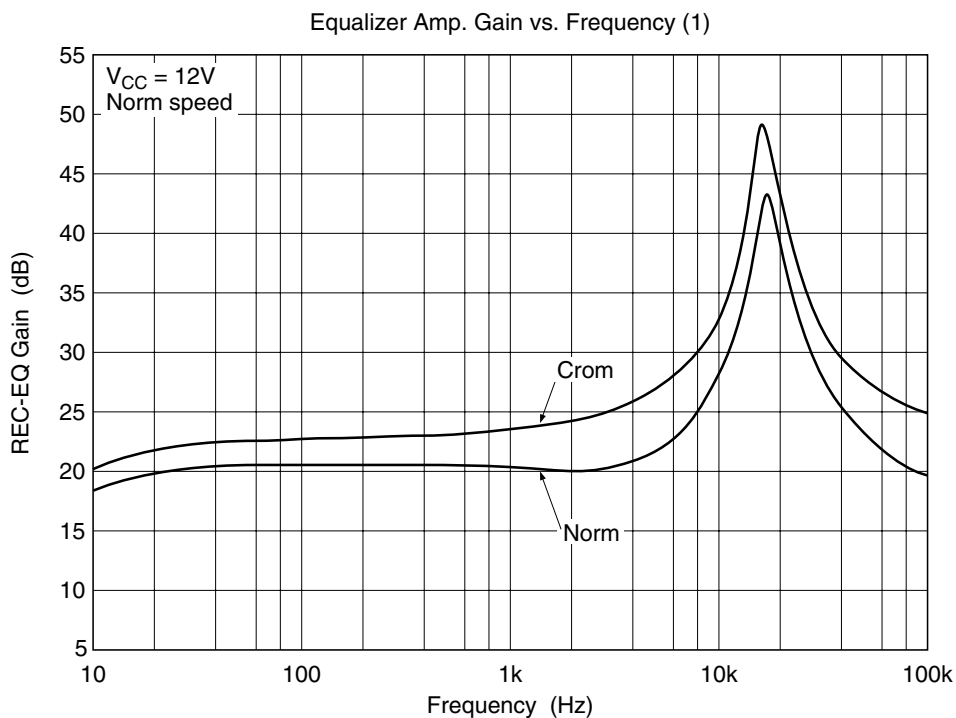
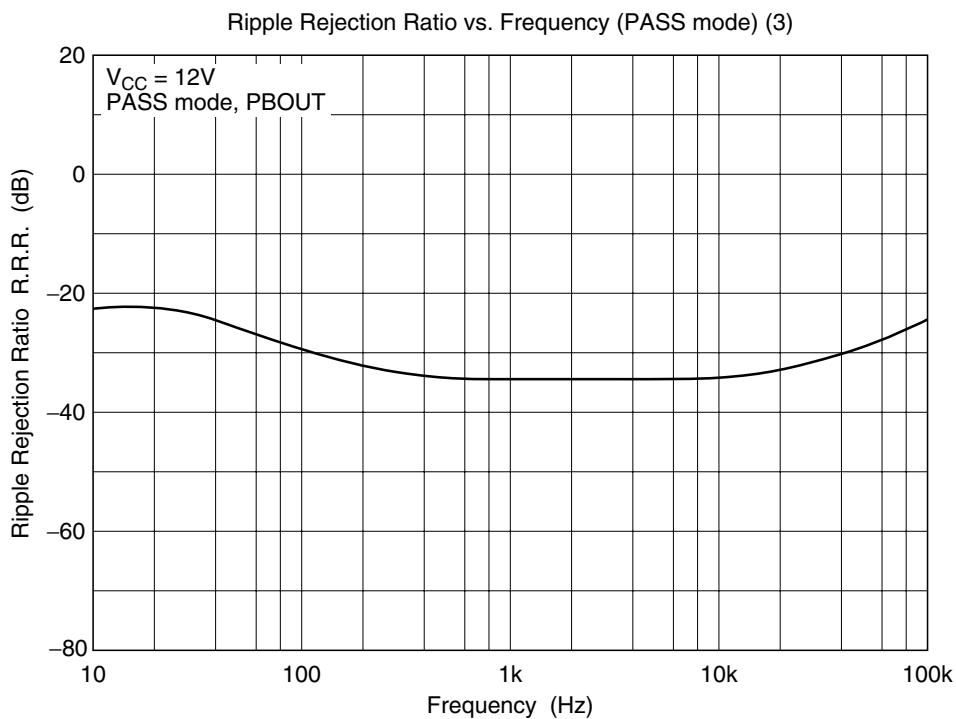

Equalizer Amp. Gain vs. Frequency (2)

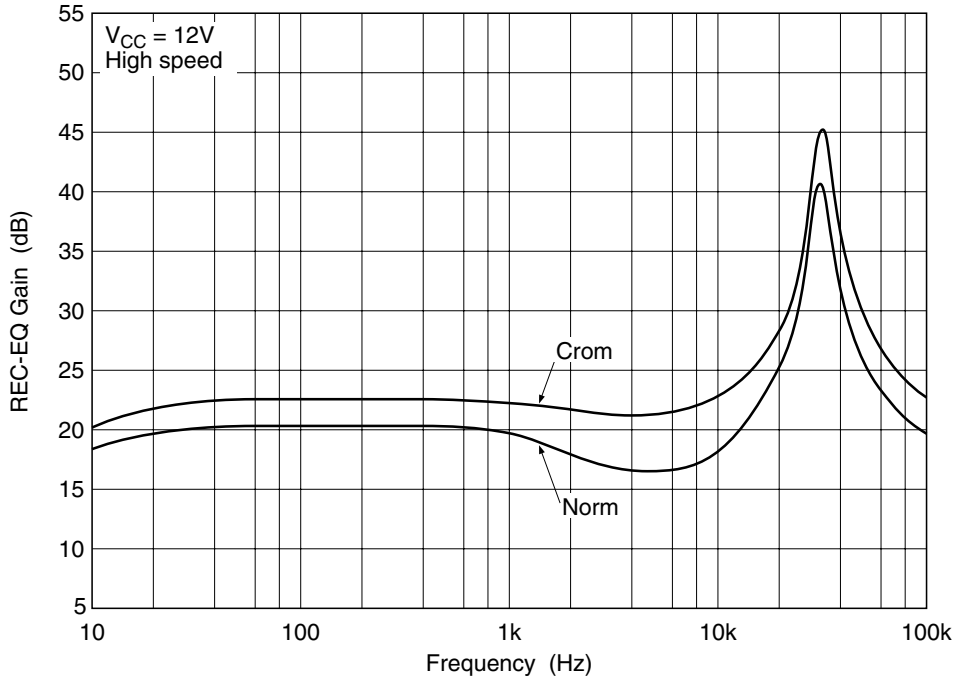

Equalizer Amp. Gain vs. Frequency (REC-cal)

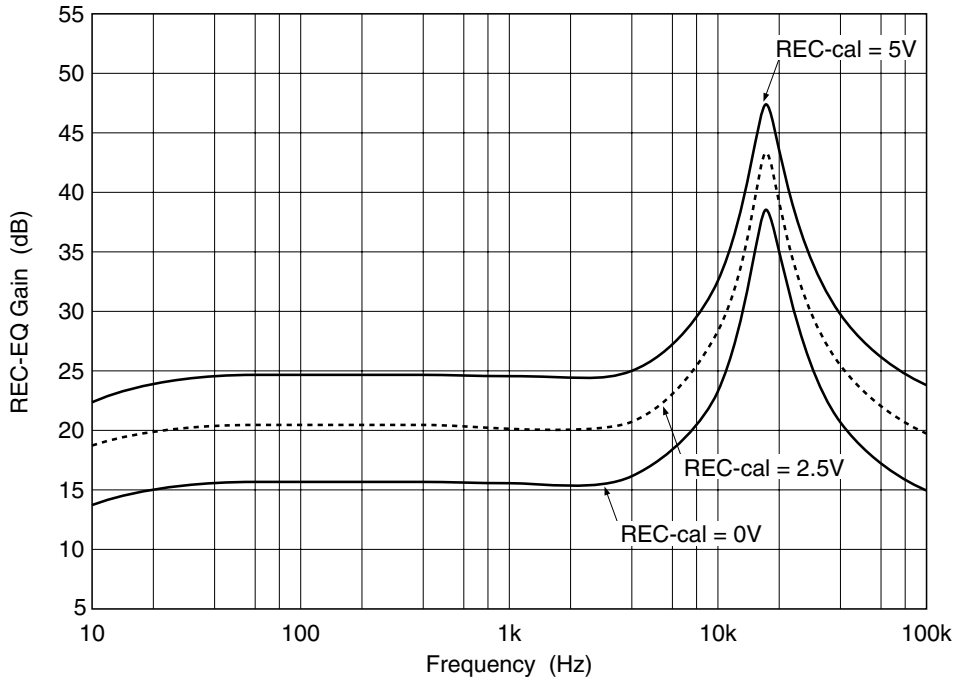

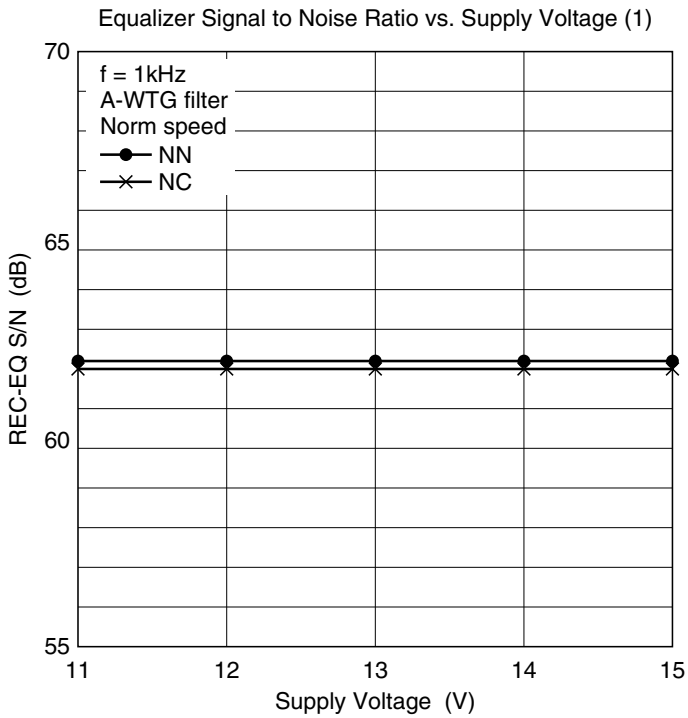
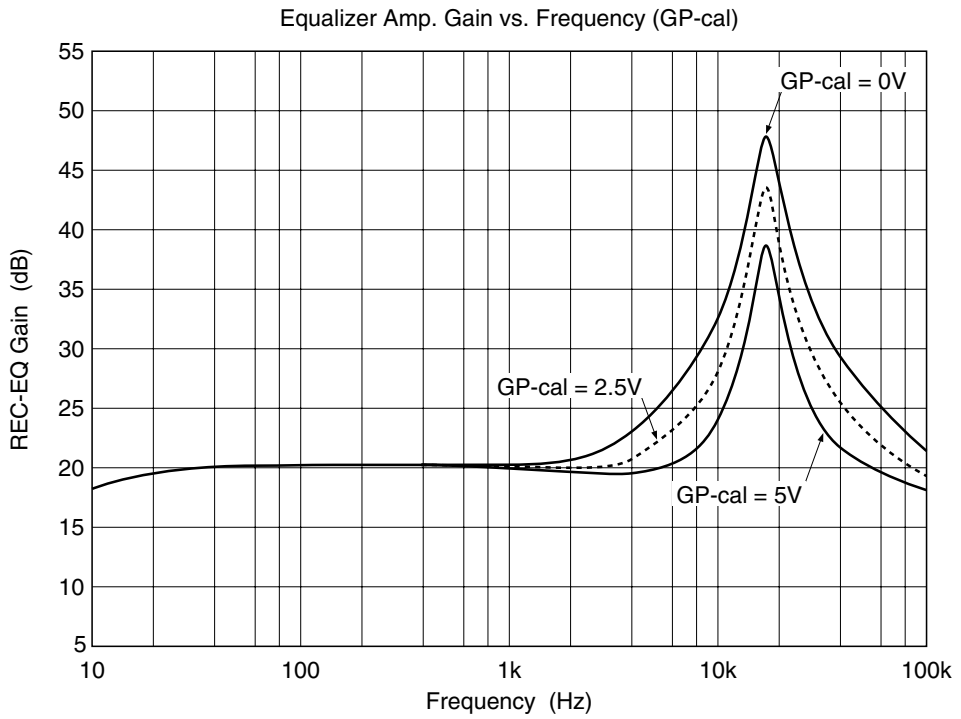

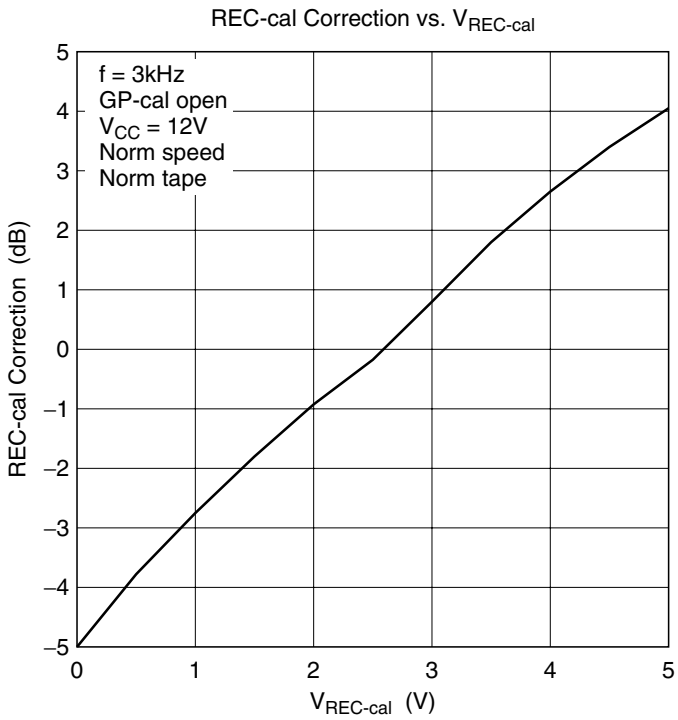
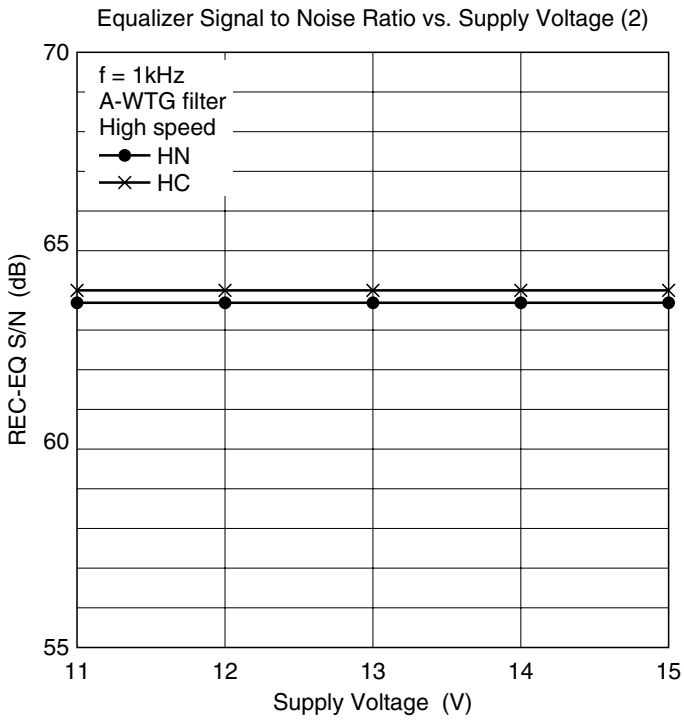

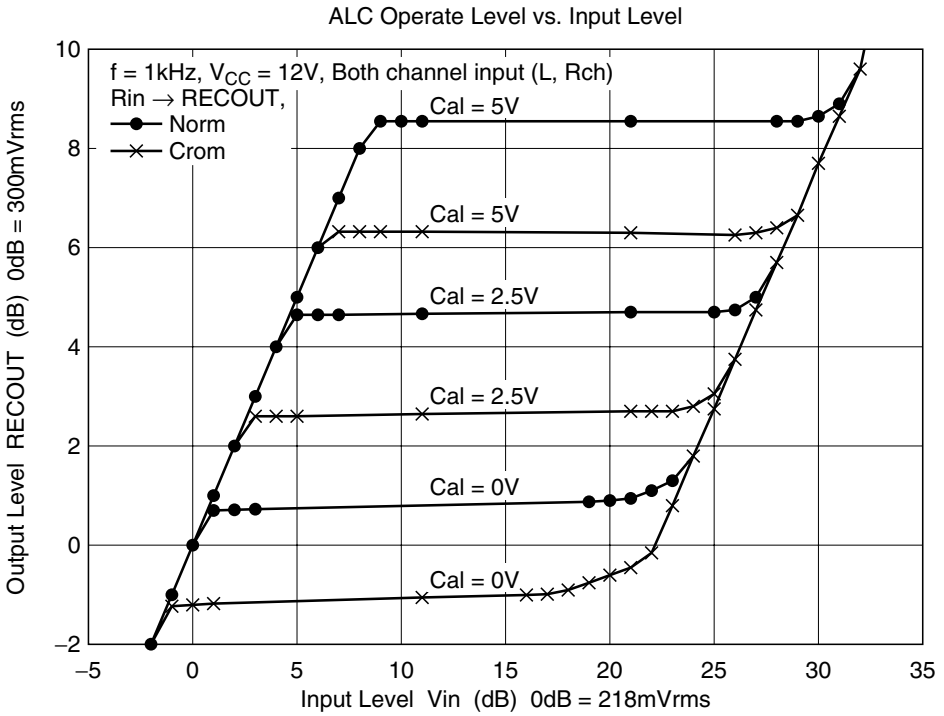
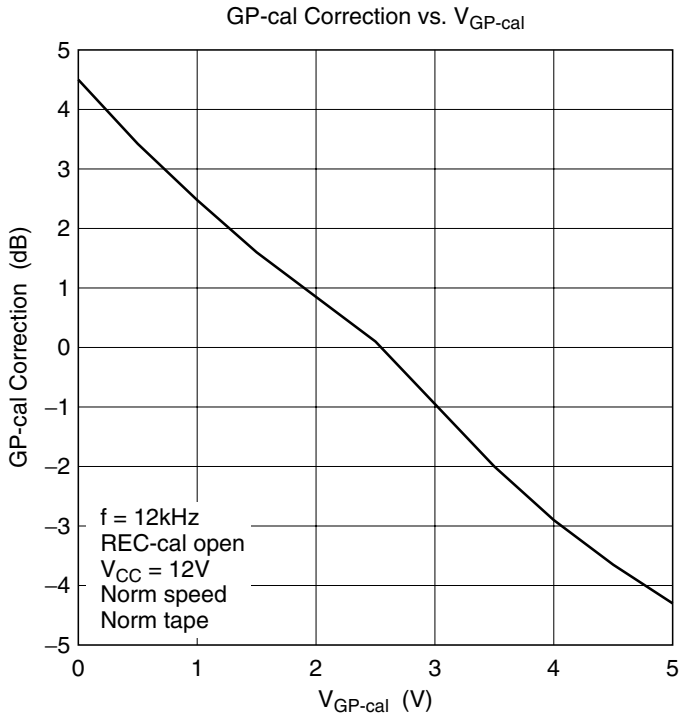

ALC Total Harmonic Distortion vs. Input Level (1)

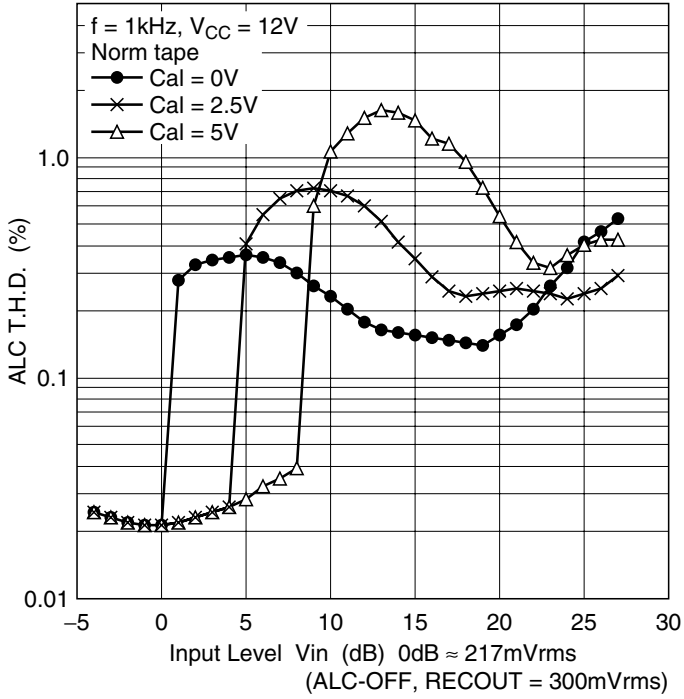

ALC Total Harmonic Distortion vs. Input Level (2)

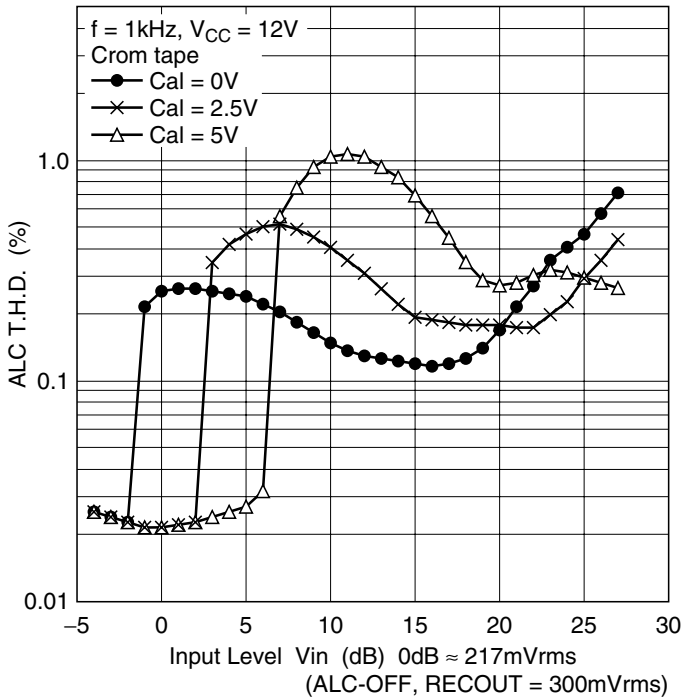

ALC Operate Level vs. Frequency

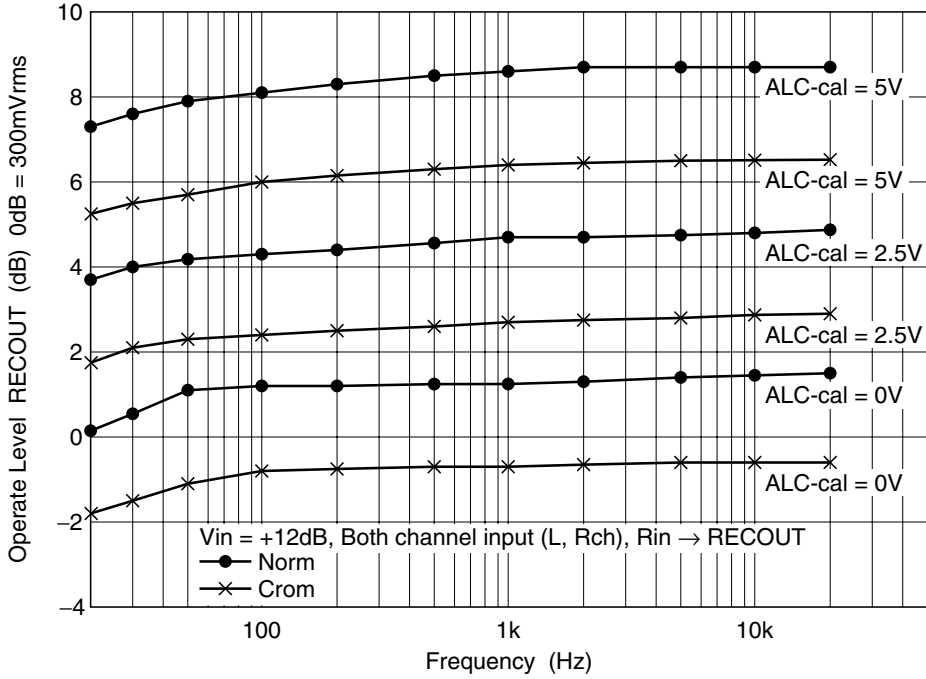

Bias Output Voltage vs. Load Current

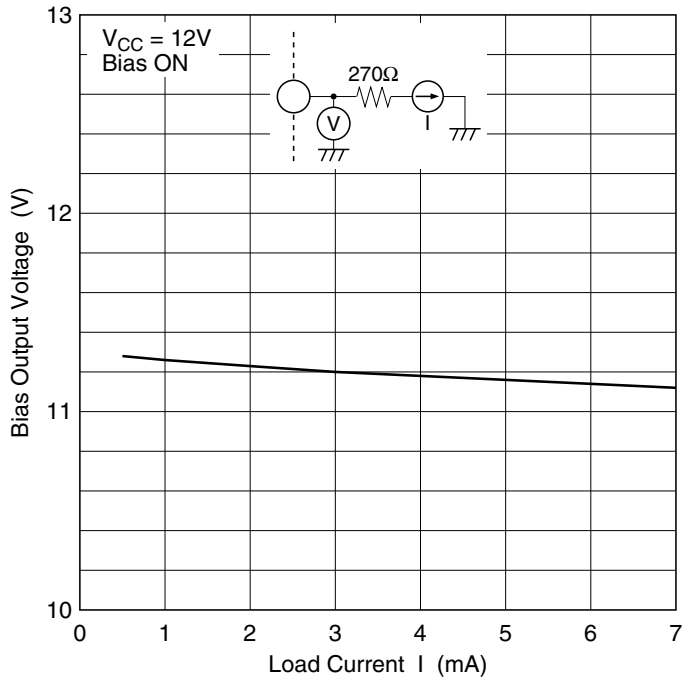

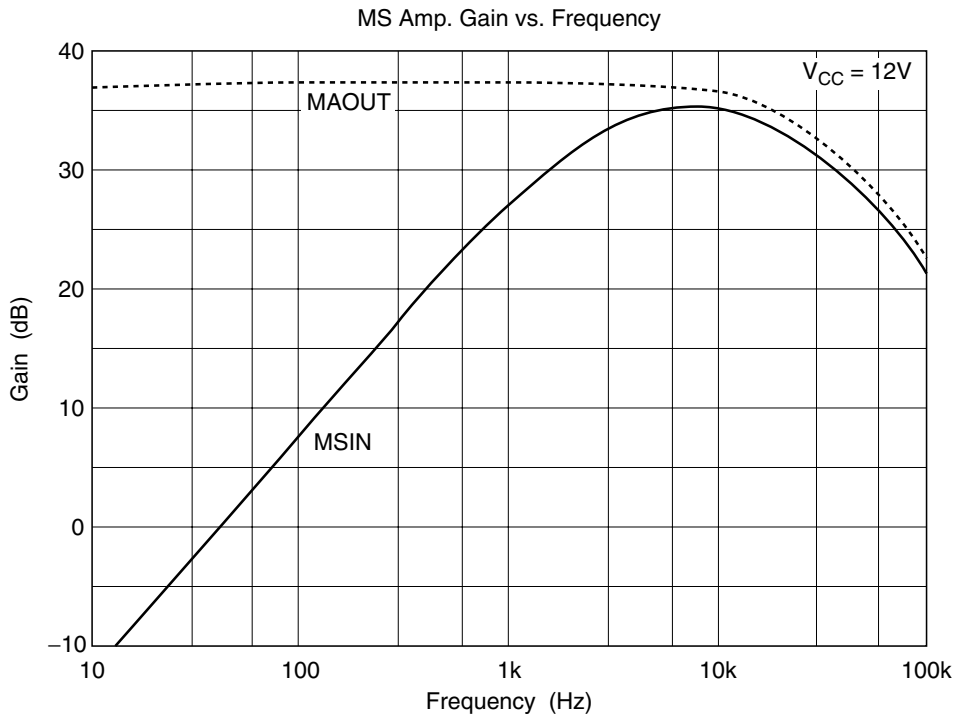
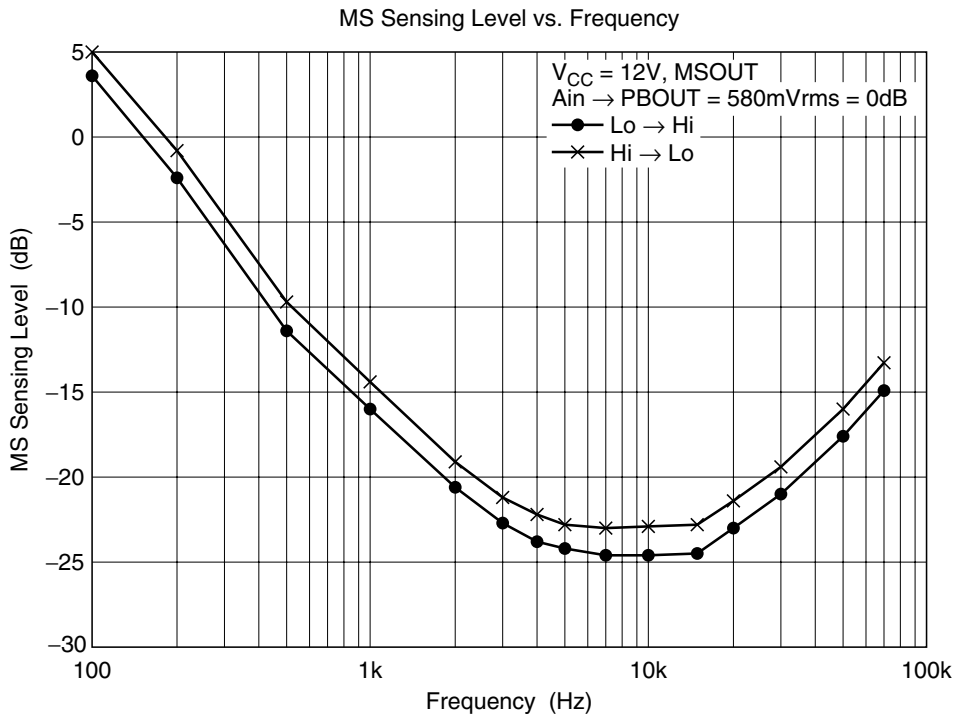

No-Signal Sensing Time vs. Resistance

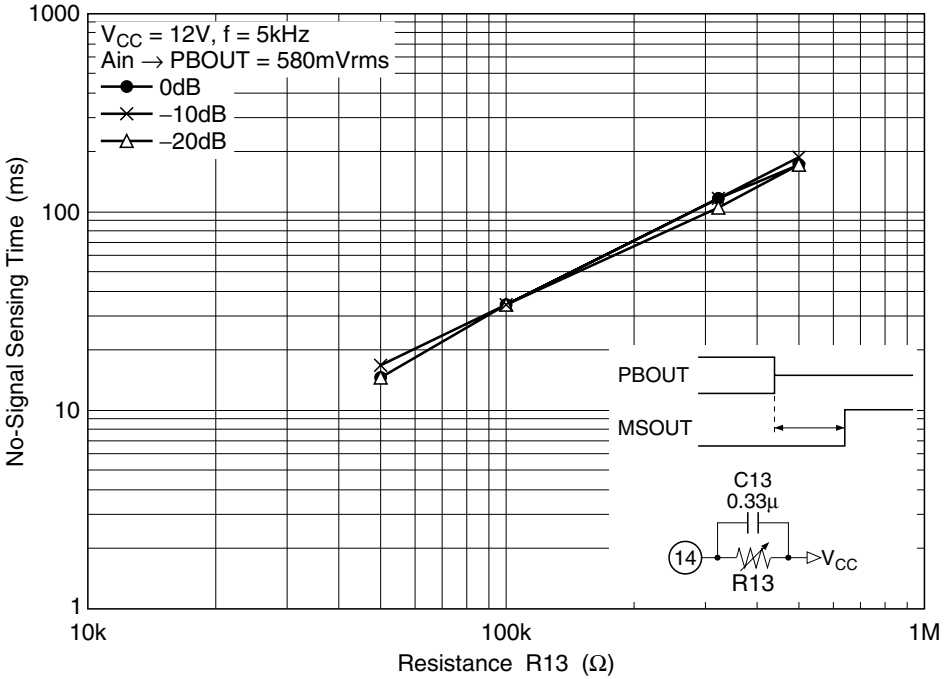

Signal Sensing Time vs. Capacitance

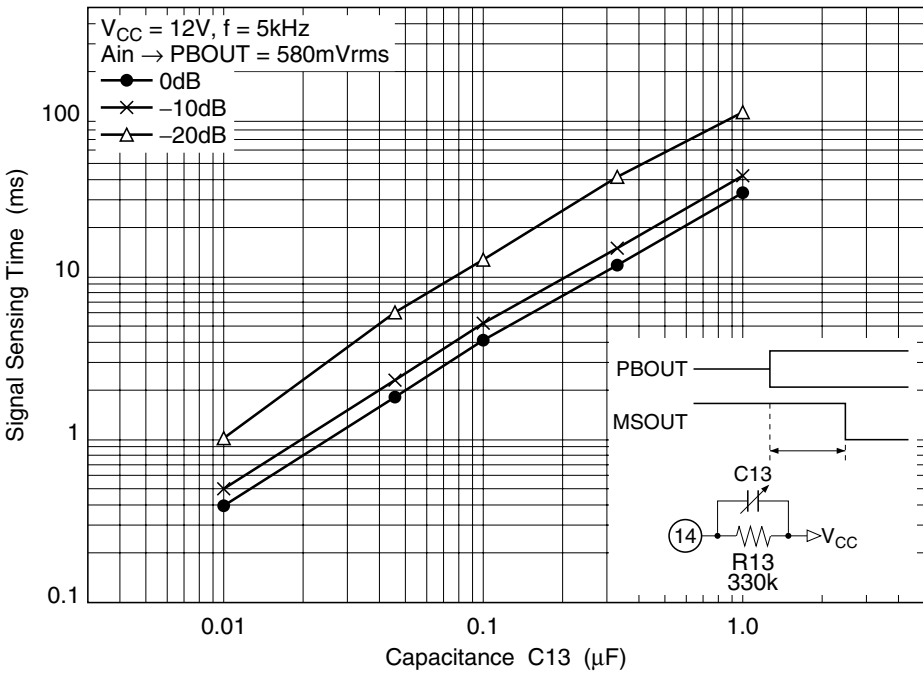

Package Dimensions

Unit: mm

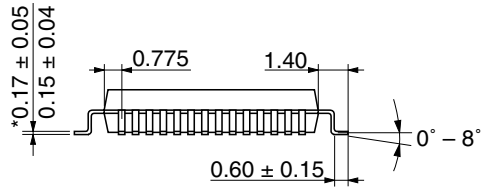
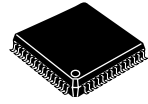
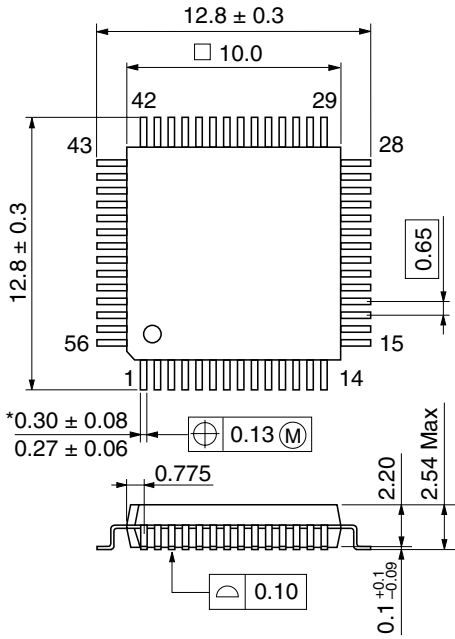

*Dimension including the plating thickness
Base material dimension

Hitachi Code	FP-56A
JEDEC	—
EIAJ	—
Mass (reference value)	0.5 g

Disclaimer

1. Hitachi neither warrants nor grants licenses of any rights of Hitachi's or any third party's patent, copyright, trademark, or other intellectual property rights for information contained in this document. Hitachi bears no responsibility for problems that may arise with third party's rights, including intellectual property rights, in connection with use of the information contained in this document.
2. Products and product specifications may be subject to change without notice. Confirm that you have received the latest product standards or specifications before final design, purchase or use.
3. Hitachi makes every attempt to ensure that its products are of high quality and reliability. However, contact Hitachi's sales office before using the product in an application that demands especially high quality and reliability or where its failure or malfunction may directly threaten human life or cause risk of bodily injury, such as aerospace, aeronautics, nuclear power, combustion control, transportation, traffic, safety equipment or medical equipment for life support.
4. Design your application so that the product is used within the ranges guaranteed by Hitachi particularly for maximum rating, operating supply voltage range, heat radiation characteristics, installation conditions and other characteristics. Hitachi bears no responsibility for failure or damage when used beyond the guaranteed ranges. Even within the guaranteed ranges, consider normally foreseeable failure rates or failure modes in semiconductor devices and employ systemic measures such as fail-safes, so that the equipment incorporating Hitachi product does not cause bodily injury, fire or other consequential damage due to operation of the Hitachi product.
5. This product is not designed to be radiation resistant.
6. No one is permitted to reproduce or duplicate, in any form, the whole or part of this document without written approval from Hitachi.
7. Contact Hitachi's sales office for any questions regarding this document or Hitachi semiconductor products.

Sales Offices

HITACHI

Hitachi, Ltd.

Semiconductor & Integrated Circuits.

Nippon Bldg., 2-6-2, Ohte-machi, Chiyoda-ku, Tokyo 100-0004, Japan

Tel: Tokyo (03) 3270-2111 Fax: (03) 3270-5109

URL	NorthAmerica	: http://semiconductor.hitachi.com/
	Europe	: http://www.hitachi-eu.com/hel/ecg
	Asia	: http://sicapac.hitachi-asia.com
	Japan	: http://www.hitachi.co.jp/Sicd/indx.htm

For further information write to:

Hitachi Semiconductor
(America) Inc.
179 East Tasman Drive,
San Jose, CA 95134
Tel: <1> (408) 433-1990
Fax: <1> (408) 433-0223

Hitachi Europe GmbH
Electronic Components Group
Dornacher Straße 3
D-85622 Feldkirchen, Munich
Germany
Tel: <49> (89) 9 9180-0
Fax: <49> (89) 9 29 30 00

Hitachi Europe Ltd.
Electronic Components Group.
Whitebrook Park
Lower Cookham Road
Maidenhead
Berkshire SL6 8YA, United Kingdom
Tel: <44> (1628) 585000
Fax: <44> (1628) 585160

Hitachi Asia Ltd.
Hitachi Tower
16 Collyer Quay #20-00,
Singapore 049318
Tel: <65>-538-6533/538-8577
Fax: <65>-538-6933/538-3877
URL: <http://www.hitachi.com.sg>

Hitachi Asia Ltd.
(Taipei Branch Office)
4/F, No. 167, Tun Hwa North Road,
Hung-Kuo Building,
Taipei (105), Taiwan
Tel: <886>-(2)-2718-3666
Fax: <886>-(2)-2718-8180
Telex: 23222 HAS-TP
URL: <http://www.hitachi.com.tw>

Hitachi Asia (Hong Kong) Ltd.
Group III (Electronic Components)
7/F., North Tower,
World Finance Centre,
Harbour City, Canton Road
Tsim Sha Tsui, Kowloon,
Hong Kong
Tel: <852>-(2)-735-9218
Fax: <852>-(2)-730-0281
URL: <http://www.hitachi.com.hk>

Copyright © Hitachi, Ltd., 2000. All rights reserved. Printed in Japan.
Colophon 2.0