

CobraNet™

Programmer's Reference

Version 2.1

Replaces DS651PM20

Preliminary Product Information

This document contains information for a new product.
Cirrus Logic reserves the right to modify this product without notice.

Features

Digital Audio Networking Processor

CobraNet

- Real-time Digital Audio Distribution via Ethernet
- No Overall Limit on Network Channel Capacity
- Supports Switched and Repeater Fast Ethernet Networks
- Fully IEEE 802.3 Ethernet Standards Compliant
- Fiber Optic and Gigabit Ethernet Variants Supported
- Ethernet infrastructure can be used simultaneously for audio and data communications.
- Free *CobraCAD*™ Audio Network Design Tool
- High-quality Audio Sample Clock Delivery Over Ethernet
- Uncompressed 16-, 20-, and 24-bit Audio Transport
- Professional 48-kHz and 96-kHz Sample Rate
- Low (1-1/3 ms) Latency
- Flexible Many-to-many Network Audio Routing Capabilities
- Available in a family of modules and low cost devices, most without licensing fees or royalties.

CobraNet Interface

- Auto-negotiating, 100-Mbit, Full-duplex Ethernet Connections
- Up to 64 Audio Channel I/O Capability
- Implements CobraNet protocol for real-time transport of audio over ethernet.
- Local Management via 8-bit Parallel Host Port
- UDP/IP Network Stack with Dynamic IP Address Assignment via BOOTP or RARP
- Remote Management via Simple Network Management Protocol (SNMP)
- Available module form factor allows for flexible integration into audio products.
- 100-MIPS Digital Signal Processor
- Non-volatile Storage of Configuration Parameters
- Safely Upgrade Firmware over Ethernet Connection
- LED Indicators for Ethernet Link Activity, Conductor Status, and Fault Annunciation
- Watchdog Output for System Integrity Assurance
- Comprehensive Power-on Self Test (POST)
- Error and Fault Reporting and Logging Mechanisms

Host Interface

- 8-bit Data, 3- or 4-bit Address
- Virtual 24- or 32-bit Data and Addressing
- Polled, Interrupt, and DMA Modes of Operation
- Configure and Monitor CobraNet Interface
- Transmit and Receive Ethernet Packets at 100-Mbit Wire Speed

Asynchronous serial interface

- Full-duplex Capable
- 8- and 9-bit Data Formats
- Standard Baud Rates up to 115.2 kbps
- Transmitter Tri-state Control for Multi-drop Networking

Synchronous Serial audio Interface

- 4 Bi-directional Interfaces Supporting Up to 64 Channels of Audio I/O
- 48- and 96-kHz Sample Rates
- 64FS, 128FS, and 256FS Bit Rates Supported
- Supports numerous synchronous serial formats including I²S
- Up to 32-bit Data Resolution

Audio clock interface

- 4 Host Audio Clocking Modes for Maximum Flexibility in Digital Audio Interface Design
- Low-jitter, 512FS (24.576 MHz) Master Clock Oscillator
- Synchronize to Supplied Master and/or Sample Clock
- Sophisticated jitter attenuation assures network perturbations do not affect audio performance.

Audio routing and processing

- Single-channel Granularity in Routing from Synchronous Serial Audio Interface to CobraNet Network
- Two levels of audio routing indirection absorbs any quirks in audio I/O interface design in host system.
- Local Audio Loopback and Output Duplication Capability
- Peak-reading Audio Metering with Ballistics

General Description

CobraNet is a combination of hardware (the CobraNet interface), network protocol, and firmware. CobraNet operates on a switched Ethernet network or on a dedicated Ethernet repeater network. CobraNet provides the following additional communications services for an Ethernet network.

- *Isynchronous Audio Data Transport*
- *Sample Clock Distribution*
- *Control and Monitoring Data Transport*

The CobraNet interface performs synchronous-to-isochronous and isochronous-to-synchronous

Digital Audio Networking Processor

conversions as well as the data formatting required for transporting real-time digital audio over the network.

The CobraNet interface utilizes standard Ethernet. It has the added capability to carry and utilize other Ethernet and IP compatible protocols for control and monitoring such as Simple Network Management Protocol (SNMP) and User Datagram Protocol (UDP) through the same network connection. This capability is shown below as unregulated traffic. Data communications and CobraNet applications can coexist on the same physical network in most cases.

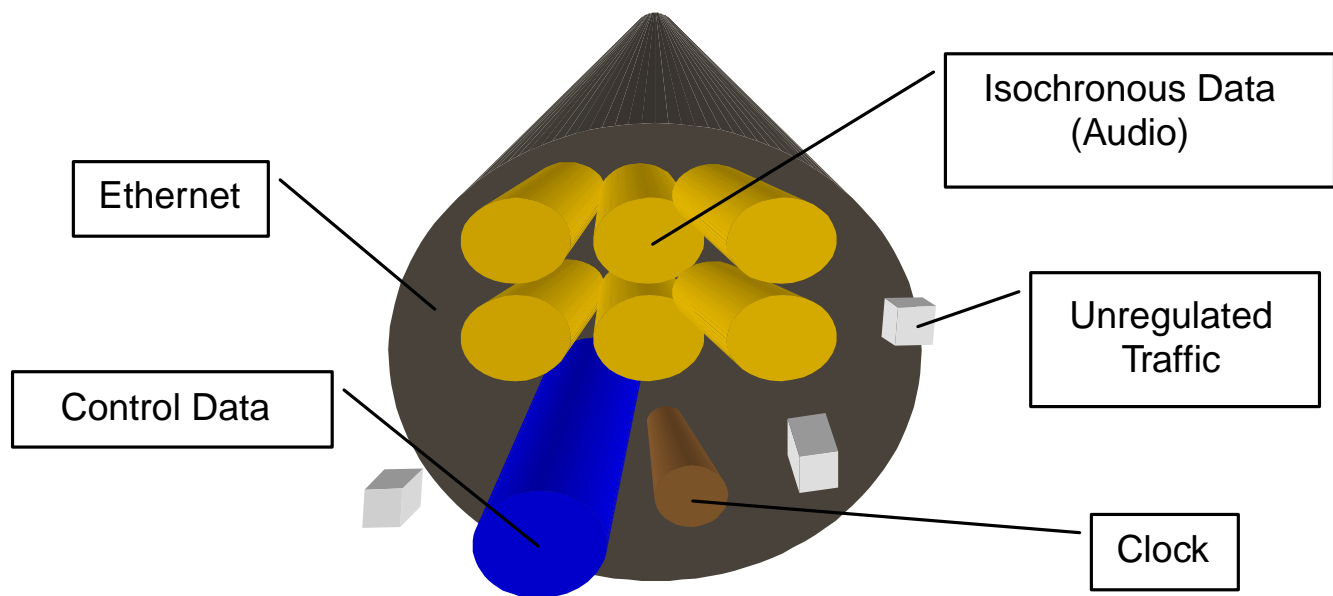

Figure 1. Digital Audio Distribution via Ethernet

- NOTES -

Table of Contents

Features	2
General Description	3
1. Overview	7
1.1 CobraNet Terminology	7
1.2 Protocol	8
1.2.1 Beat Packet	8
1.2.2 Isochronous Data Packet (or Bundle)	8
1.2.3 Reservation Packet	9
1.2.4 Serial Bridge Packet	9
1.3 Timing and Performance	9
1.4 Bundle Addressing types	9
2. Control Communications	11
2.1 Serial Bridge	11
2.2 Packet Bridge	12
2.2.1 Packet Bridge Buffer Data Format	12
Processor-dependent Layout of Packet Bridge Buffers	12
24-bit HMI Packet Bridge Buffer Data Format	13
32-bit HMI Packet Bridge Buffer Data Format	13
2.2.2 Packet Bridge Receive Filtering	14
3. Synchronization	16
3.3 CobraNet Audio Clock Block Diagram	16
3.4 Synchronization Modes	16
3.4.1 Internal	17
3.4.2 Internal with External Sample Synchronization	17
3.4.3 External Word Clock	17
3.4.4 External Master Clock	17
3.4.5 External Master Clock with External Sample Synchronization	18
4. Network Stack	19
4.1 CobraNet Audio	19
4.2 Serial Bridge	19
4.3 Packet Bridge	19
4.4 BOOTP	19
4.5 RARP (partial support)	20
4.6 ICMP (partial support)	20
4.7 ARP	20
4.8 IP	20
4.9 UDP	21
4.10 TFTP	21
4.11 SNMP	21
5. Audio Paths	22
5.1 Audio Routing Channels	23
5.2 Bundle Transmitters	23
5.3 Bundle Receivers	23
5.4 Loopback	23
5.5 Output Channel Duplication	24
5.6 Meters	24
5.7 Low-latency Audio Support	24
5.8 96-kHz Sample Rate Support	26
6. Management Interface	28
6.1 Flash	28
6.2 Persistence	29
6.3 Watch Dog	29
6.4 SNMP Extension Agent	30

7. Management Interface Variable Reference	31
7.1 Legend	31
7.2 Data Types	31
7.2.1 DisplayString	31
7.2.2 OID	32
7.2.3 IpAddress	32
7.2.4 PhysAddress	32
7.2.5 TimeTicks	33
7.2.6 Counter	34
7.2.7 Counter2	34
7.2.8 Integer	34
7.2.9 Integer16	34
7.2.10 Integer48	35
7.3 MIB-II Variables	36
7.3.1 System	36
7.3.2 Interface	40
7.3.3 Address Translation	48
7.3.4 IP	49
7.3.5 UDP	56
7.3.6 SNMP	58
7.4 CobraNet Variables	68
7.4.1 Firmware	68
7.4.2 Hardware Identification	71
7.4.3 Flash	73
7.4.4 Errors	78
7.4.5 Conductor	81
7.4.6 Packet Bridge	83
7.4.7 Serial Bridge	88
7.4.8 Interrupt Control	91
7.4.9 Audio	94
7.4.10 Receivers	103
7.4.11 Transmitters	107
7.4.12 Synchronization	112
7.4.13 SNMP Monitor	115
7.4.14 MI Monitor	116
7.4.15 IP Monitor	117
7.4.16 IF Monitor	118
8. Recommended User Interface Practices	120
8.1 Channel Assignments and Labeling	120
8.1.1 Audio I/O Map	120
8.1.2 Bundle Assignments	120
8.2 Conductor Priority	121
8.3 Name	121
9. Error Reporting	122
9.1 Recoverable Errors	122
9.1.1 Receive and Transmit Errors	122
9.1.2 Faults	122
9.2 Unrecoverable Errors	122
9.2.1 Fatal Faults	122
9.2.2 POST Failure	123
10. Error Code Reference	124
10.1 Legend	124
10.2 Error Code Interpretation	124
10.2.1 Extraction of Byte Code for 32-bit Interfaces	124
10.2.2 Optional Extraction of Byte Code for 24-bit Interfaces	125
10.3 Error Codes Listing	125
11. Legal Notice	139

1. Overview

1.1 CobraNet Terminology

CobraNet is a technology that combines state of the art audio and communications technologies. While each have their own terminology, the following terms are used to refer to elements specific to CobraNet.

Audio Channel—A CobraNet digital audio channel operates with a sample rate 48 kHz or 96 kHz and a sample size of 16, 20, or 24 bits.

Bundle—A Bundle* is the basic CobraNet audio routing element and can carry 0 to 8 audio channels. Bundles are assigned a number which determines both which interface the Bundle is routed to and in what manner. The range within which the Bundle number falls determines whether it is routed as a *multicast*, *unicast*, or *private* type. Bundles are numbered 1 through 65535. CobraNet interfaces are capable of sending and receiving multiple bundles simultaneously. Bundle numbers are described in more detail in [Table 2., "Bundle Numbering"](#) .

*Bundles were formerly referred to as channels or network channels and may be seen represented as such in some SNMP variable names and older documentation.

CobraNet Device—A CobraNet device is any equipment containing one or more CobraNet interfaces.

CobraNet Interface—The CobraNet interface is the hardware (or hardware design) and software supplied by Cirrus Logic to manufacturers of CobraNet enabled equipment. Several generations of the CobraNet interface exist and will interoperate with each other:

CS181xx - A family of CobraNet chips containing one or more 32-bit, 100 MIPS DSP cores, RAM and audio I/O circuitry.

CM-2 - A modular CobraNet interface based on a CS181xx chip family.

CM-1 - A modular CobraNet interface based on a 24-bit, 100 MIPS DSP.

CS18101 Reference Design - A CobraNet design based on the CS18101. This is essentially a CM-2 without the modular circuit board and host interface connector.

24-bit Platform - CobraNet interfaces based on 24-bit DSPs: Reference design, CM-1.

32-bit Platform - CobraNet interfaces based on 32-bit DSPs: CS181xx, CM-2.

Reference Design - A CobraNet interface design based on a 24-bit, 40 MIPS DSP.

Conductor—The conductor is the CobraNet interface elected to provide master clock and transmission arbitration for the network. The role of the conductor and the means for selecting a conductor are described elsewhere in this document. All CobraNet devices other than the conductor operate in a **performer** role.

Isochronous cycle - One or more CobraNet bundles are transmitted each isochronous cycle. The period of an isochronous cycle is 750 Hz or 1-1/3 mS

Host Management Interface (HMI) - The hardware (8-bit bi-directional parallel interface) and protocol for accessing MI variables locally. The HMI is described in detail in the CS181xx Hardware Manual and CM-1 Hardware Manual.

Management Interface (MI) - The set of variables used to control and monitor the CobraNet interface. MI variables are accessible both locally through the *Host Management Interface (HMI)* and over the network using *Simple Network Management Protocol (SNMP)*. MI variables are described in detail in [Section 7. "Management Interface Variable Reference" on page 31](#).

Packet Bridge - A function provided by the CobraNet protocol which allows a CobraNet interface to send and receive raw Ethernet packets over the same Ethernet media used for audio transmission.

Performer - A CobraNet interface which receives its transmission permissions and master clock from a conductor. In the event a conductor fails, the CobraNet protocol will automatically promote a performer to become the new conductor.

Receiver - A logical entity within the CobraNet interface capable of receiving one Bundle.

Serial Bridge - A function provided by the CobraNet protocol which allows a CobraNet interface to send and receive asynchronous (i.e. RS-232) data over the same Ethernet media used for audio transmission.

Transmitter - A logical entity within the CobraNet interface capable of transmitting one Bundle.

1.2 Protocol

The CobraNet protocol operates at the Data Link Layer also referred to as OSI Layer 2 or MAC layer. CobraNet uses four basic packet types described below. All CobraNet packets are identified with a unique Ethernet protocol identifier (0x8819) assigned to Cirrus Logic. As CobraNet is a Local Area Network (LAN) technology and not a Wide Area Network (WAN) technology, CobraNet does not utilize Internet Protocol (IP) to transport audio. Packet Bridge packets are generic packets and are not identified as CobraNet packets. Packet bridging is discussed in more detail in [Section 2.2 "Packet Bridge" on page 12](#).

1.2.1 Beat Packet

A multicast packet with an address of 01:60:2B:FF:FF:00 and which contains network operating parameters, clock and transmission permissions. The beat packet is transmitted from a single CobraNet device on the network (the conductor) and indicates the start of an isochronous cycle. Since the beat packet carries the clock for the network, it is sensitive to delay variation. If the delay variation specification shown in [Table 1 on page 9](#) is not met, CobraNet devices may not be able to lock their local sample clocks to the network clock. The beat packet is typically small (on the order of 100 bytes) but can be large on a network with numerous active bundles.

1.2.2 Isochronous Data Packet (or Bundle)

A multicast or unicast packet. The size of the packet/bundle is dependent on the number and format of the audio channels contained in the bundle. Because CobraNet devices buffer isochronous data packets, out-of-order delivery of data packets is acceptable as long as the packet forwarding delay specifications in [Table 1 on page 9](#) are not exceeded.

1.2.3 Reservation Packet

A multicast packet with an address of 01:60:2B:FF:FF:01 used by the CobraNet protocol to allocate bandwidth and establish connections between CobraNet interfaces. CobraNet devices transmit reservation packets as needed or typically once per second at minimum.

1.2.4 Serial Bridge Packet

A multicast or unicast packet used to bridge asynchronous serial data between CobraNet interfaces. Serial bridging is discussed in more detail in [Section 2.1 "Serial Bridge" on page 11](#).

1.3 Timing and Performance

CobraNet provides real-time audio delivery and requires real-time performance from the network on which it is deployed. The best means of insuring a network will deliver the performance required by CobraNet is to verify the design using Cirrus Logic's CobraCAD CobraNet modeling software (available for download at www.cirrus.com). The design check feature in CobraCAD assures that the performance requirements shown in Table 1 are met and that the network is capable of delivering the bandwidth required to support the modeled application.

Table 1. Network Performance Requirements

Parameter	Maximum	Comments ^a
Beat Packet Delay Variation	250µs	If delivery of beat packets periodically varies from the nominal delay by more than this value, then the Receivers may lose sample lock or fail to meet clock delivery specifications
Forwarding Delay towards achieving 5-1/3ms audio propagation delay in 5-1/3ms operating mode.	400µs	Forwarding delay is the sum of store forward, queuing and propagation delays. Forwarding delay includes delay variation i.e. 150µs forwarding delay + 250µs delay variation = 400µs. Thus tolerance of forwarding delay is reduced in the presence of delay variation. Additional audio latency is added to the audio in increments of 64 sample periods (1-1/3ms) if the forwarding delay specification is violated.
Forwarding Delay	3800µs	Audio cannot be delivered at any latency with extreme forwarding delays.

- a. With the exception of the reservation packet, any dropped packet will cause an interruption in service. Dropped isochronous data packet(s) will affect only the associated bundle(s). Dropped beat packets may affect the entire network.

1.4 Bundle Addressing types

Multicast bundles represent a least common denominator for audio interoperability in CobraNet networks. Bundles sent with multicast destination addresses are delivered indiscriminately to all CobraNet interfaces and thus have the potential of overloading a network. Care should be taken to insure that an excessive number of multicast bundles are not used. See *Bundle Assignments in CobraNet Systems* (available for download at www.cirrus.com) for a discussion of issues associated with multicast bundles.

Unicast bundles are sent to only one destination on a network. However, in the event that more than one CobraNet interface is set to receive the same bundle number, the CobraNet protocol may, according to rules governed by the *txUniCastMode* and *txMaxUnicast* variables, cause unicast bundles to be sent as multicast or multi-unicast when necessary. Multi-unicast will use unicast addressing to send up to four copies of the

same bundle to different CobraNet interfaces. The default configuration for *txUnicastMode* insures that unicast bundles are never multicast.

Private bundles are a special case of unicast or multicast bundles. The transmitter's MAC address, in addition to the bundle number, is required to fully qualify a private channel at the receiver. Like unicast bundles, these may be either unicast or multicast based on *txUnicastMode*.

Note: Transmitted bundles must have a unique bundle number assigned to them. More than one transmitting interface cannot use the same bundle number. Multiple receiving interfaces can receive the same bundles.

Table 2. Bundle Numbering

Hexadecimal Bundle Number	Decimal Bundle Number	Designation	Usage	Transmission Addressing	Transmission Mode
0	0	Null	Unused bundle. Disables transmission/reception when selected.	Never transmitted.	Never transmitted.
1-0xFF	1-255	Multicast	Transmitted by a single CobraNet interface and received by any number of interfaces.	Always multicast	Always transmitted.
0x100-0xFEFF	256-65279	Unicast	Transmitted by a single CobraNet interface. Dependent on <i>txUnicastMode</i> and <i>txMaxUnicast</i> settings may be received at a single (default case), a few (multiple unicast case) or a large number (multicast case) of interfaces.	Generally unicast but may multicast if <i>txUnicastMode</i> variable is adjusted.	Only transmitted when at least one receiver is identified via reverse reservation.
0xFF00-0xFFFF	65280-65535	Private	Individual transmitters locally allocate private channels. The bundle number is conditioned on the transmitter's MAC address. There are 256 of these bundles per transmitter thus the total number of private bundles is virtually unlimited as the bundle numbers are unique to a particular MAC address.	Generally unicast but may multicast if <i>txUnicastMode</i> variable is adjusted.	Only transmitted when at least one receiver is identified via reverse reservation.

2. Control Communications

2.1 Serial Bridge

Asynchronous serial data may be bridged across the network using the serial bridge hardware and software. The CobraNet interface has a two wire logic-level asynchronous interface. Characters received on the interface are buffered and placed in the payload of a special serial bridge Ethernet packet. The packet is then transmitted onto the network with unicast or multicast addressing as configured. It is received at the destination CobraNet interface where the data in the packet is re-serialized and presented on the serial interface. Many standard asynchronous serial formats are supported. With proper physical interface circuitry, this port can be made to support RS-232, RS-422 or RS-485 standards. Multi-drop two-wire interfaces are also supported.

The bridging feature can be useful in a CobraNet product as either an internal or external control interface. Used externally, the appropriate transceiver, such as an RS-232 driver chip, is connected to the logic-level pins and in turn connected to a standard connector, such as a DB-9 or DB-25, on the back panel. This allows control of external serial interfaced devices remotely over Ethernet.

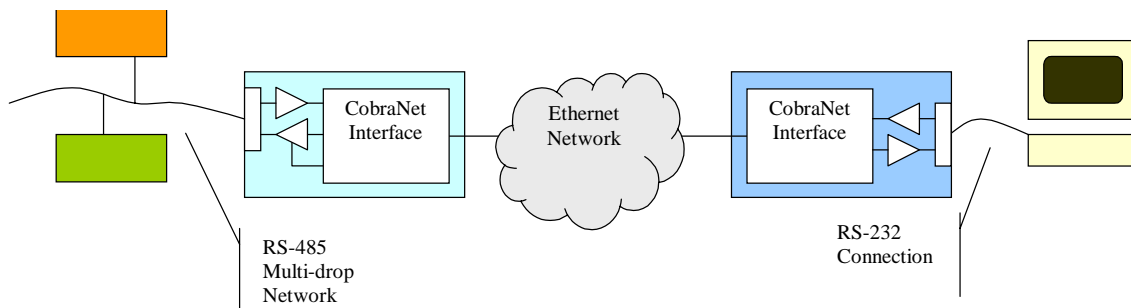

Figure 2. Serial Bridging, External Application

Internal application of the serial bridge allows serial communications over the network between host processors which are incorporated into CobraNet devices. Using this communication scheme reduces engineering effort in integrating CobraNet into audio products that already accomplish control communications via serial link.

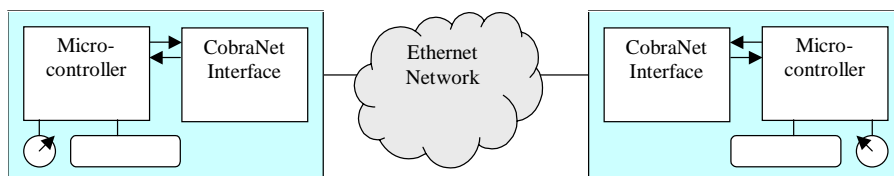

Figure 3. Serial Bridging, Internal Application

Although the serial bridging feature strives to transmit data at wire speed, delays are introduced by the process of serializing, de-serializing, and prioritizing the serial bridge packets. These delays are typically on the order of 10ms or less.

See [Table 7.4.7 on page 88](#) for details on the MI variables used to control serial bridging.

2.2 Packet Bridge

The packet bridge provides a means for using the CobraNet interface as if it were an Ethernet controller by providing a basic capability to send and receive raw Ethernet packets. A CobraNet device utilizing a host processor with network stack can use this feature to transmit and receive both control and audio data over the same network connection.

In the simplest implementation, the host sees the packet bridge as several control variables, a receive buffer, and a transmit buffer which are accessed via the HMI interface. Ethernet data packets are transferred in both directions over the host port using the same HMI semantics used to read and write other MI variables.

More advanced implementations can take advantage of interrupt and DMA modes of HMI operation as well as some HMI operations specifically tailored to packet bridge functions.

Refer to [Table 7.4.6 on page 83](#) for details on the MI variables used to control packet bridging.

2.2.1 Packet Bridge Buffer Data Format

Packets are transmitted by writing raw packet data to *bridgeTxPktBuffer*. Packets are received by reading *bridgeRxPktBuffer*. Data in both buffers shares the same format. The first word of the buffer specifies the byte length of the data that follows. Byte length includes the 14-byte Ethernet header. The Frame Check Sequence (FCS) is automatically appended to transmitted packets and automatically checked and stripped from received packets. The FCS is not included in the packet data or byte length specification. Byte length should be in the range 14 to 1514.

2.2.1.1 Processor-dependent Layout of Packet Bridge Buffers

Refer to [Table 3](#) and [Table 4 on page 13](#) for organization of data within bridge buffers for 24- and 32-bit platforms. All data marked as *unused/0* will be received as 0 and must be set to 0 when writing the buffer prior to transmission.

For both platforms, requested transmissions shorter than the 60-byte Ethernet packet minimum will be padded to 60 bytes with indeterminate data.

Table 3. Packet Bridge Buffer Layout, 24-bit Platforms

	MS	Middle	LS
Word 1	Packet byte length MS	Packet byte length LS	unused/0
Word 2	Destination MAC byte 2	Destination MAC byte 3	unused/0
Word 2	Destination MAC byte 4	Destination MAC byte 3	unused/0
Word 3	Destination MAC byte 6	Destination MAC byte 5	unused/0
Word 4	Source MAC byte 2	Source MAC byte 1	unused/0
Word 5	Source MAC byte 4	Source MAC byte 3	unused/0
Word 6	Source MAC byte 6	Source MAC byte 5	unused/0
Word 7	Protocol identifier LS	Protocol identifier MS	unused/0
Word 8	Payload byte 2	Payload byte 1	unused/0
...	unused/0
Word n	Payload byte n	Payload byte n-1	unused/0

2.2.1.2. 24-bit HMI Packet Bridge Buffer Data Format

Packet byte length is specified in the two MS bytes of the first word. The LS bytes will read 0 on receipt and must be set to 0 for transmit. Transmit byte length is rounded up to the nearest even multiple of 4. Receive byte length indicates the actual number of bytes received.

2.2.1.3. 32-bit HMI Packet Bridge Buffer Data Format

Packet data begins with the second word. Transmission order of each word is MH, MS, LS, ML.

Table 4. Packet Bridge Buffer Layout, 32-bit Platforms

	MS	MH	ML	LS
Word 1	Byte length MS	Byte length LS	unused/0	unused/0
Word 2	Destination MAC byte 2	Destination MAC byte 1	Destination MAC byte 4	Destination MAC byte 3
Word 3	Destination MAC byte 6	Destination MAC byte 5	Source MAC byte 1	Source MAC byte 2
Word 4	Source MAC byte 4	Source MAC byte 3	Source MAC byte 6	Source MAC byte 5
Word 5	Protocol identifier LS	Protocol identifier MS	Payload byte 2	Payload byte 1
Word 6	Payload byte 4	Payload byte 3	Payload byte 6	Payload byte 5
...
Word n	Payload byte n-2	Payload byte n-3	Payload byte n	Payload byte n-1

2.2.2 Packet Bridge Receive Filtering

The packet bridge can allow *only selected* packets to be passed to the bridge buffer or allow *copies* of packets to be sent to the bridge buffer. The value of the *bridgeRxFilter* variable controls the filter mode. With *bridgeRxFilter* = 0x10 or 0x01 the packet bridge sends selected packets of unknown protocol to the HMI interface via the packet bridge buffer. With *bridgeRxFilter* = 0x02 or 0x08, copies of selected packets are passed both to the packet bridge *and* are processed by the CobraNet interface. The packet bridge never passes audio data packets or beat packets to the host. The operation of packet bridge filtering is shown in Figure 4 below.

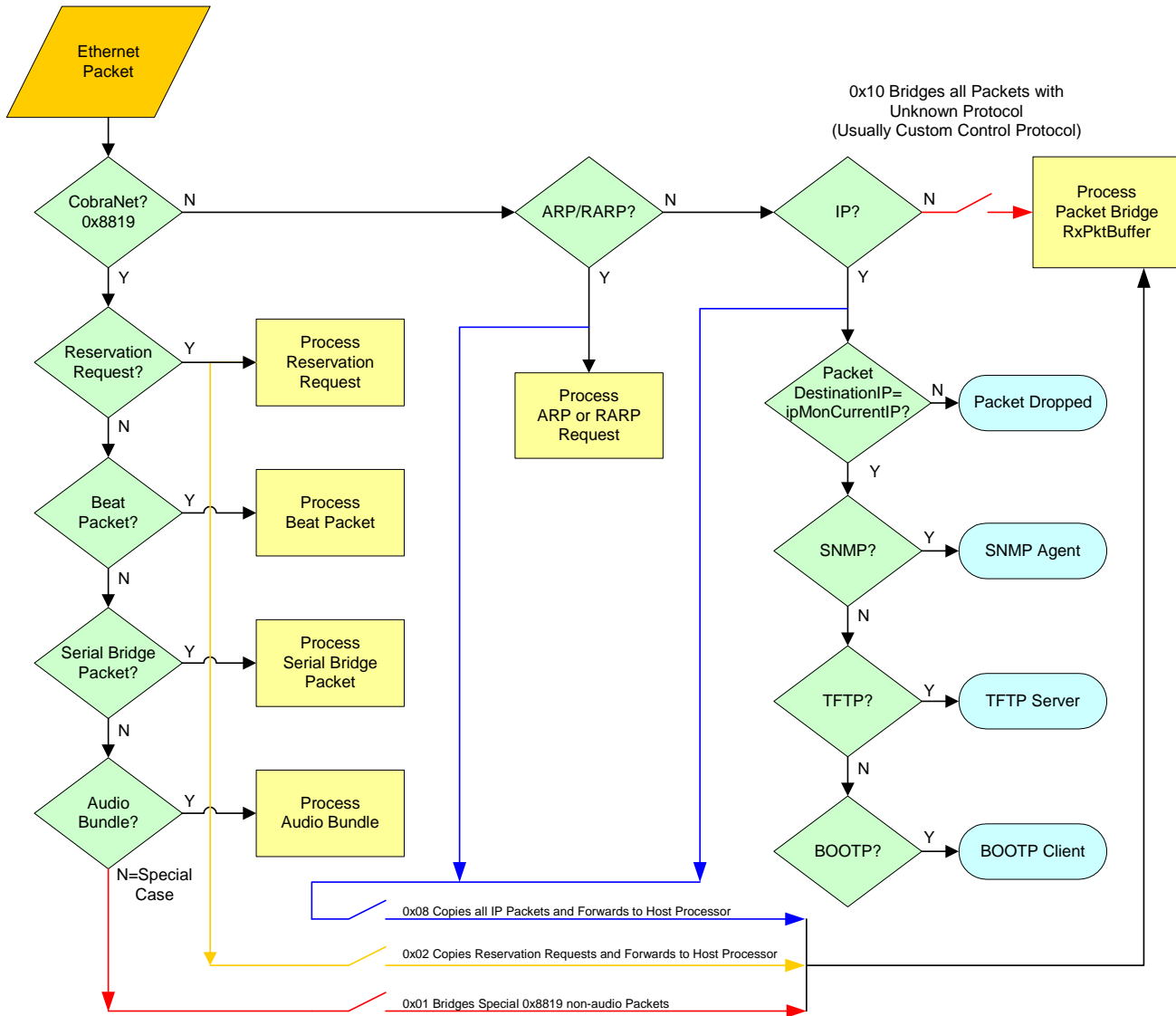

Figure 4. Packet Bridge Receive Filtering

The default value of *BridgeRxFilter* is 0x01. When *BridgeRxFilter* is set to 0x08 and/or 0x02, the CobraNet interface and the host processor can independently process the same packets. The Host processor can use 0x08 in order to respond to packets with IP addresses other than the address assigned to the CobraNet interface. Care must be taken in the host processor software when using these modes to ensure that the CobraNet interface and Host Processor do not both respond to the same packets.

3. Synchronization

3.3 CobraNet Audio Clock Block Diagram

This diagram shows clock-related circuits on the CobraNet interface. This circuitry allows the synchronization modes documented below to be achieved. Modes are distinguished by different settings of the multiplexors and software elements.

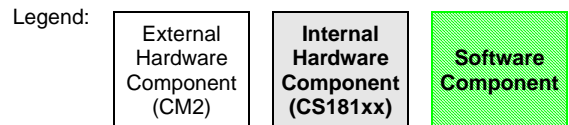
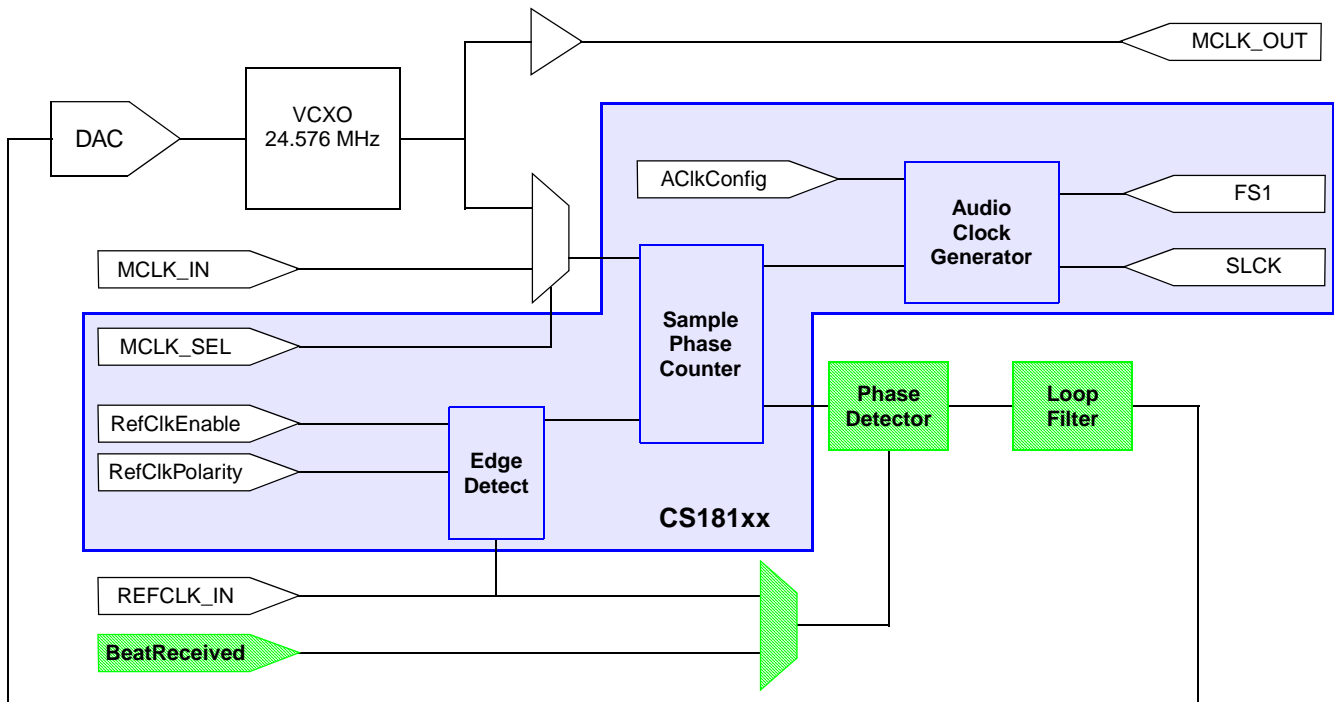

Figure 5. Audio Clock Sub-system

3.4 Synchronization Modes

Although the clocking architecture of CobraNet interfaces is very flexible, the standard internal synchronization mode will function well for most applications. Other modes accommodate specific system needs. CobraNet clock synchronization modes are set independently for conductor and performer roles via the *syncConductorClock* and *syncPerformerClock* MI variables. Refer to [Figure 5 on page 16](#) for a graphical representation of the clocking architecture. The role (conductor vs. performer) is determined by the network environment including both the conductor priority (*condPriority*) of the device and of other devices on the network. See [Section 1.1 "CobraNet Terminology" on page 7](#) and [Section 8.2 "Conductor Priority" on page 121](#) for definitions of conductor and performer roles.

3.4.1 Internal

All CobraNet clocks are derived from the onboard Voltage Controlled Crystal Oscillator (VCXO). The master clock generated by the VCXO is available to external circuits via MCLK_OUT.

Conductor—The VCXO frequency can be adjusted by the *syncClockTrim* setting. Clock trim adjustments are not necessary in most cases. The default *syncClockTrim* setting is appropriate.

Performer—The VCXO frequency is steered to match the clock transmitted by the conductor.

3.4.2 Internal with External Sample Synchronization

This mode is identical to internal mode except it allows synchronization of audio clocks (FS1, SCLK) to an external source via REFCLK_IN. This additional functionality is useful when adapting the CobraNet interface to a device that contains circuitry for generating these audio clocks from the master clock (MCLK_OUT).

Conductor—The VCXO frequency can be adjusted by the *syncClockTrim* setting.

Performer—The VXCO is steered to match the clock transmitted by the conductor.

3.4.3 External Word Clock

All CobraNet clocks are derived from an onboard VCXO which is steered from an external clock supplied to REFCLK_IN. The clock supplied can be any integral factor of the sample clock in the range of 750 Hz to 48 kHz.

External synchronization lock range: $\pm 5\mu\text{s}$. This specification indicates possible drift or wander plus error between the supplied clock and the generated clocks.

Conductor—This mode gives a means for synchronizing an entire CobraNet network to an external clock.

Performer—The interface will disregard the fine timing information delivered over the network from the conductor. Fine timing information will instead be supplied by REFCLK_IN. REFCLK_IN must be synchronous with the network conductor. This mode may be useful in installations where a house sync source is readily available.

3.4.4 External Master Clock

The VCXO is disabled and MCLK_IN is used as the master clock for the interface. This is a “hard” synchronization mode. The supplied clock is used directly by the CobraNet interface for all timing. The supplied clock must be 24.576 MHz for CobraNet modules and CS181xx or 12.288 MHz for Reference Design hardware.

Conductor—The entire network is synchronized to the supplied clock.

Performer—The interface will initially lock to the network clock and will “jam sync” via the supplied master clock. The external clock source must be synchronous with the network conductor. This mode is primarily useful for CobraNet devices containing multiple CobraNet interfaces.

3.4.5 External Master Clock with External Sample Synchronization

This mode is identical to External Master Clock mode except that it allows synchronization of the audio clocks (FS1, SLCLK) to an external source via REFCLK_IN. This additional functionality is useful when using the CobraNet interface with a device that contains circuitry for generating these clocks from the master clock (MCLK_OUT).

Conductor—The entire network is synchronized to the supplied clock.

Performer—The interface will initially lock to the network clock and will “jam sync” via the supplied master clock. The external clock source must be synchronous with the network conductor. This mode is useful for devices with multiple CobraNet interfaces.

4. Network Stack

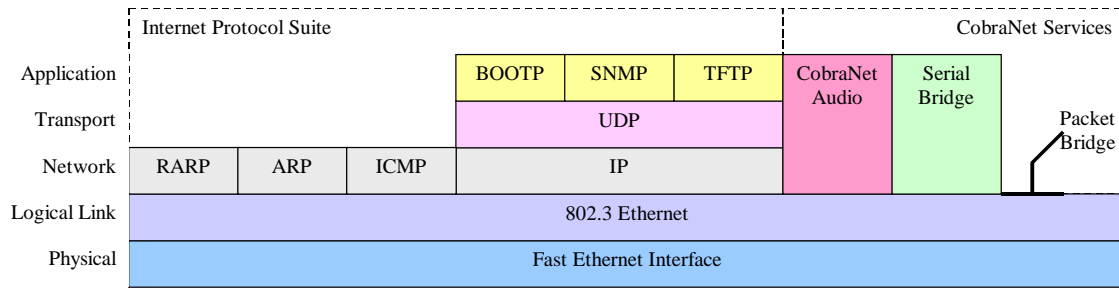

Figure 6. CobraNet Network Stack

4.1 CobraNet Audio

This includes transmission and reception of audio data packets and reservation requests, implementation of conductor arbitration, and the ability to serve in either conductor or performer roles. CobraNet audio is a self-contained service that spans from Logical Link (2) to Application (7) layers.

4.2 Serial Bridge

This service provides bridging of asynchronous serial streams over the Ethernet network. This self-contained service spans from the logical link to the Application layer. The serial bridge service is discussed in [Section 2.1 "Serial Bridge" on page 11](#).

4.3 Packet Bridge

This service simply allows the CobraNet interface to operate as an Ethernet controller for a connected host. This service works at the logical link layer and provides access to the network without providing any actual network services. The packet bridge feature is discussed in [Section 2.2 "Packet Bridge" on page 12](#).

4.4 BOOTP

The boot protocol (BOOTP) is supported as specified in RFCs 951 and 1542. Network clients use BOOTP to receive an IP address from a BOOTP server.

Clients needing an IP address will broadcast a BOOTP request packet. A BOOTP server on the network will respond with a BOOTP response containing the preferred IP address for the client to use. Use of BOOTP simplifies the error-prone task of assigning unique IP addresses to devices on a large network. BOOTP is carried via UDP/IP and, as such, is able to pass through properly configured routers.

BOOTP requests are transmitted by the CobraNet interface on a randomized schedule as recommended in the RFCs. Requests are sent out frequently at startup and then taper

down to an approximate 2-per-minute minimum rate. Two conditions must be met before a CobraNet device will send out BOOTP requests:

- The device must not already have an IP address. Apart from BOOTP, there are two other means for a CobraNet interface to obtain an IP address - RARP and the *ipMonitor* variables.
- The device must be attached to a switched network. In order to avoid producing unregulated traffic, BOOTP requests are not transmitted on a repeater network.

Upon receipt of a valid BOOTP response, a CobraNet device will change its IP address to the IP address indicated by the BOOTP response. It is not necessary for a response to be paired with a specific request to be considered valid.

4.5 RARP (partial support)

RFC 903 defines reverse address resolution protocol (RARP). Network clients use RARP to receive an IP address from a central server. RARP differs from BOOTP in that it is carried at the logical link layer (Layer 2) and thus cannot pass through IP routers.

RARP is comprised of request and response packet types. Upon receipt of a valid RARP response packet, a CobraNet device will change its IP address to the IP address indicated by the RARP response. The CobraNet network stack does not transmit RARP request packets.

RARP is the means used by the CobraNet Discovery application (Disco) and CNDisco object for IP address assignment.

4.6 ICMP (partial support)

Internet control message protocol (ICMP) is an administrative protocol defined in RFC 972.

CobraNet devices which have been assigned an IP address will respond to ICMP echo (commonly referred to as 'ping') requests. No other ICMP support is implemented in the CobraNet network stack.

4.7 ARP

Address resolution protocol (ARP) is used by the IP protocol to translate IP addresses to MAC addresses according to RFC 826.

A host seeking a MAC address associated with an IP address broadcasts an ARP request. The device using the specified IP address replies with an ARP response packet. In this way the requesting host obtains the MAC address for the target device.

The CobraNet interface responds to ARP requests when appropriate. CobraNet will not generate ARP requests. For this reason the CobraNet can only respond to IP messages and cannot initiate IP communications.

4.8 IP

The internet protocol (IP) is defined in RFC 791. IP is a network protocol (layer 3 of the OSI 7-layer networking model) responsible for routing of packets and segmentation and reassembly of packets.

The CobraNet implementation of IP has the following limitations:

- Segmentation and reassembly is not supported. Segmentation is primarily utilized by stream based TCP protocols that can generate large data packets. Reassembly capability can be necessary on heterogeneous networks (those comprising multiple network technologies such as Ethernet, FDDI, and ISDN).
- Cannot initiate IP communications; can only respond to incoming messages. The CobraNet implementation does not support net mask and default gateway concepts required to initiate communications to other subnets. Furthermore, CobraNet's implementation of ARP does not support generation of ARP requests.

4.9 UDP

User datagram protocol (UDP) is defined in RFC 768. UDP is a transport protocol (layer 4 of the OSI 7-layer networking model) responsible for maintaining the integrity of data. UDP is an extremely simple protocol which, by design, defers the data integrity problem to application protocols in higher network layers.

CobraNet fully supports UDP.

4.10 TFTP

Trivial file transfer protocol (TFTP) is defined in RFC 783. TFTP supports file read and write via a UDP/IP transport. The CobraNet implementation of TFTP supports only binary reads and writes to a specific set of files. This is the mechanism used to update firmware in a CobraNet interface. The TFTP file names correspond to the different sectors of the FLASH memory and can differ in name and size for different revisions of CobraNet interface hardware.

Firmware update is a complex process best accomplished by use of an encapsulated software module, such as the PACNFirm object library, or by use of the CobraNet Discovery program which are aware of the data structures and protocol utilized.

4.11 SNMP

Version 1 of the simple network management protocol (SNMP) is defined in RFC 1157. The CobraNet SNMP interface is version 1 compliant.

A management information base (MIB) is associated with any SNMP implementation. CobraNet supports the standard MIB for network devices as defined in RFC 1213 "MIB-II" in addition to its own MIB for CobraNet-specific objects.

The CobraNet MIB file is available for public download in order to facilitate full use of the CobraNet SNMP interface via SNMPv1 compliant applications.

5. Audio Paths

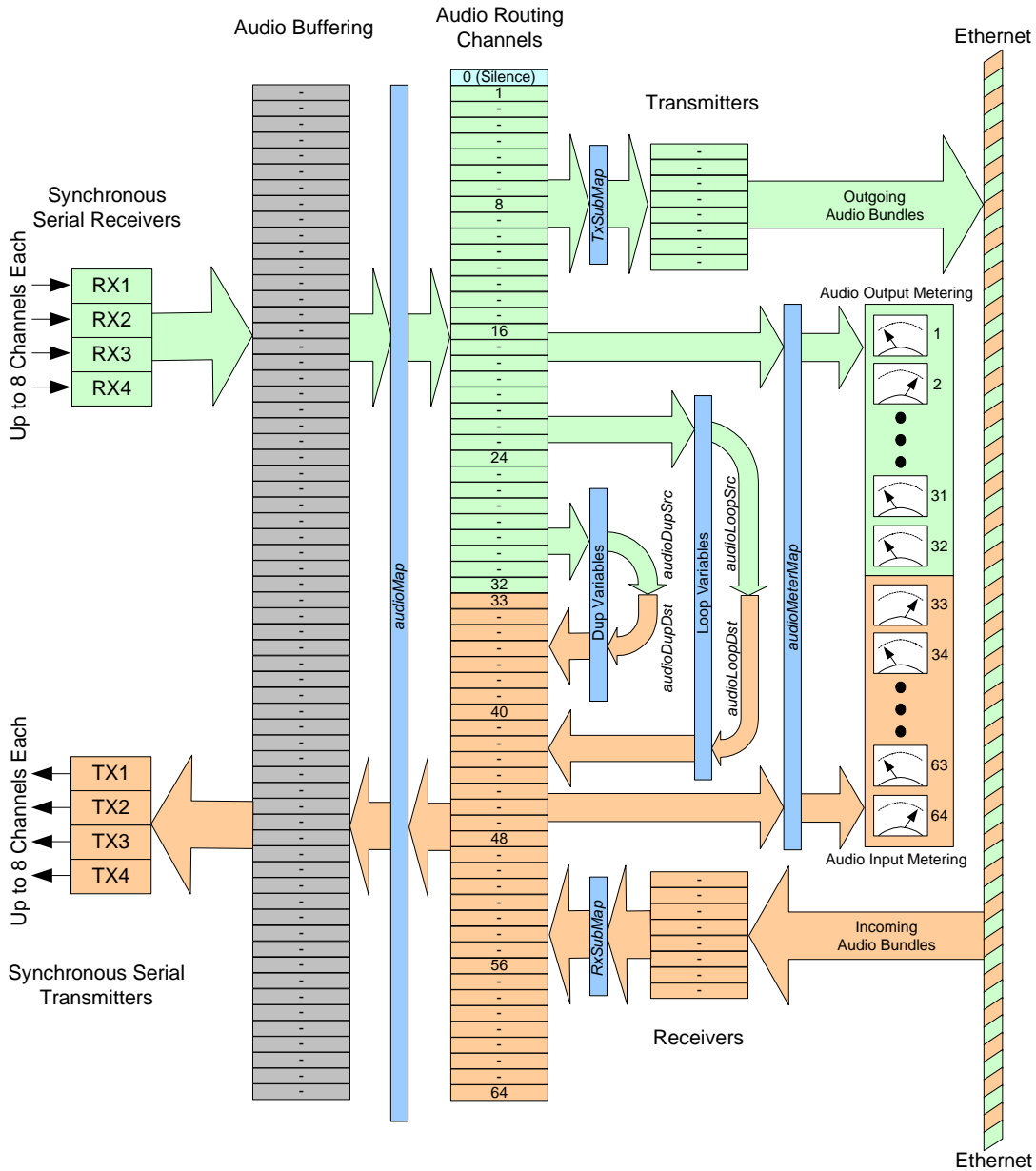

NOTES: 1. Do not alter audioMap, use txSubMap and rxSubMap to control routing to/from Bundles and SSI.
 2. The number of transmitters and receivers may vary depending on the implementation.

Figure 7. CobraNet Interface Audio Model

5.1 Audio Routing Channels

There are 65 audio routing channels within a CobraNet interface numbered from 0 to 64. Channels 1 through 32 are used to route audio from the Synchronous Serial Interface (SSI) to the network transmitters. Channels 33 through 64 are used to route audio from the network receivers to the SSI outputs. Routing channel 0 is a special logical channel used to supply silence to a transmitted channel or serve as a “bit bucket” when receiving from the network.

Audio arrives and leaves the interface through the SSI receivers and transmitters. As each sample arrives it is buffered. The mapping of audio input and output channels to audio I/O buffer offsets is fixed (and non-intuitive). To accommodate channel numbering differences of different CobraNet devices, the *audioMap* variables allow a mapping from audio I/O buffer offsets to routing channel numbers. This mapping is preset by the manufacturer and should never need to be altered.

5.2 Bundle Transmitters

A Transmitter is a logical entity within the CobraNet interface capable of transmitting one bundle of up to 8 audio channels. Input audio routing channels (0, 1 through 32) are mapped into Bundles associated with a particular transmitter via the *txSubMap* variables associated with that transmitter. There are 8 *txSubmap* variables associated with each transmitter, each of which can be set to a particular routing channel number. The first *txSubMap* variable sets the routing channel that will be transmitted in the first audio channel in the bundle. The second *txSubmap* variable selects the source for the second audio channel to be transmitted in the bundle...and so on.

Audio resolution (sample size) and sample rate (48 kHz or 96 kHz) are determined by other transmitter parameters discussed in this document.

5.3 Bundle Receivers

A Receiver is a logical entity within the CobraNet interface capable of receiving one bundle of up to 8 audio channels. Output audio routing channels (0, 33 through 64) are mapped from the receiver via the *rxSubMap* variables. There are 8 *rxSubMap* variables associated with each receiver, each of which can be set to a particular routing channel number. The first *rxSubMap* variable selects the routing channel that will receive the first audio channel in the bundle. The second *rxSubMap* variable specifies mapping the second audio channel in the bundle...and so on.

5.4 Loopback

The loopback object provides a means for the interface to transfer audio channels internally. Loopback overcomes the limitation that a device cannot receive its own transmission and also allows the audio I/O system to be tested locally.

The *audioLoopSource* and *audioLoopDest* variables control this feature.

5.5 Output Channel Duplication

The audio routing channel mapping facilities allow a single routing channel to be mapped to any number of audio channels in any number of network transmitters (Bundles). It is, however, not possible to direct an audio channel in a network receiver to multiple audio routing channels for output through multiple SSI channels or ports.

Output channel duplication allows output routing channels to be copied to other output routing channels. This feature is implemented as a separate set of “dup” paths controlled by *audioDupSource* and *audioDupDest* variables. An output can be specified as the source for a duplication by multiple “dup” paths. Output duplication is accomplished without incurring additional audio latency. See [Section 7.4.9 "Audio" on page 94](#) for more information.

5.6 Meters

Metering is provided for all 64 audio routing channels. The first 32 meters can be mapped to the 32 input routing channels. The second 32 meters are used to meter the output routing channels. Mapping is controlled by the *audioMeterMap* variable.

Metering is disabled by default to conserve processing cycles. Meters are peak detecting with simple first-order decay ballistics. Ballistics are comprised of an instantaneous attack and exponential decay time programmable via *audioMeterDecay* variable. Ballistics are adjusted globally for all meters. All level measurements are peak level (as opposed to RMS, for instance). Level is indicated in 24- or 32-bit positive signed values. A cumulative peak hold element on each meter allows accurate detection of any clipping condition. See [Section 7.4.9 "Audio" on page 94](#) for more information.

5.7 Low-latency Audio Support

Low-latency modes are supported on CobraNet interfaces without need for hardware changes to the CobraNet interface or CobraNet Device. The default mode of operation is 5-1/3 mS latency at 48-kHz sample rate.

Running in low-latency mode requires more processing power, implying a trade-off between the number of channels supported and reduction of latency. Some reference-design-based products need to operate at reduced channel count to support lower latency. Depending on selected sample size, sample rate, and latency, newer CobraNet interfaces may be subject to some limitation in channel capacity, number of transmitters and receivers, and multiple unicast transmission count.

The following table shows CM-1 channel capacity for several latency and sample rate operating modes. Eight-channel bundles with 20-bit resolution, unicast to a single destination or multicast is assumed.

Low-latency modes also place additional demands on network performance. Specifically, in order to achieve the desired latency, forwarding delay across the network needs to be reduced by approximately the same factor that audio latency is reduced. These requirements bring into play new network design rules.

Lower latency is achieved by transmitting smaller audio packets at a higher rate. A restriction on the number of audio channels allowed in a bundle is due to a restriction on

the maximum size of an Ethernet packet. Therefore Lower-latency modes have relaxed restrictions in this area. Audio channel count restrictions are summarized below.

Table 5. Bundle Capacity Limits as a Function of Ethernet Packet Size

Latency	Channels per Bundle					
	16 bit, 48 kHz	20 bit, 48 kHz	24 bit, 48 kHz	16 bit, 96 kHz	20 bit, 96 kHz	24 bit, 96 kHz
5-1/3 ms	8	8	7	5	4	3
2-2/3 ms	8	8	8	8	8	7
1-1/3 ms	8	8	8	8	8	8

Bundle capacity or maximum channel count may be limited in some cases by both the allowable Ethernet packet size and by the processor bandwidth required to handle lower latency and/or higher sample rate modes. Limitations imposed by packet size are illustrated in [Table 5](#). Limitations imposed by additional bandwidth requirements are discussed in the Hardware Reference Manual applicable to the particular CobraNet Interface.

A CobraNet interface operates at a single latency and sample rate mode as specified by the *modeRateControl* variable. This latency mode applies to all incoming and outgoing audio at the interface.

Table 6. *txSubFormat* and *rxSubFormat*¹ Values²

<i>txSubFormat</i> Value	Resolution	Sample Rate	Latency
0	No Signal		
0x044000	16 bit	48 kHz	5-1/3 ms
0x054000	20 bit	48 kHz	5-1/3 ms
0x064000	24 bit	48 kHz	5-1/3 ms
0x148000	16 bit	96 kHz	5-1/3 ms
0x158000	20 bit	96 kHz	5-1/3 ms
0x168000	24 bit	96 kHz	5-1/3 ms
0x042000	16 bit	48 kHz	2-2/3 ms
0x052000	20 bit	48 kHz	2-2/3 ms
0x062000	24 bit	48 kHz	2-2/3 ms
0x144000	16 bit	96 kHz	2-2/3 ms
0x154000	20 bit	96 kHz	2-2/3 ms
0x164000	24 bit	96 kHz	2-2/3 ms
0x041000	16 bit	48 kHz	1-1/3 ms
0x051000	20 bit	48 kHz	1-1/3 ms
0x061000	24 bit	48 kHz	1-1/3 ms
0x142000	16 bit	96 kHz	1-1/3 ms
0x152000	20 bit	96 kHz	1-1/3 ms
0x162000	24 bit	96 kHz	1-1/3 ms

¹*rxSubFormat* is a read only variable indicating the format of the audio data being received and decoded. It will have the same value as *txSubFormat* with the exception of the least-significant bit. i.e. 16-bit, 48-kHz sample rate, 5 1/3-mS latency = 0x44001 when the data is being successfully decoded.

²*modeRateControl* must also be set to the correct value necessary to support the mode selected by *txSubFormat*.

5.8 96-kHz Sample Rate Support

A CobraNet interface may operate at either 48 kHz or 96 kHz but not both rates simultaneously. A device operating at 48 kHz cannot receive audio from a device operating at 96 kHz and vice versa. However, CobraNet interfaces operating at 96 kHz and 48 kHz audio may co-exist on the same network.

CS181xx, CM-2, and CM-1 based interfaces are required for 96-kHz sample rate operation. No hardware changes are required to support the increased sample rate on these platforms. 96 kHz is not supported in the legacy CobraNet Reference Design.

Sample rate is selected by the *modeRateControl* variable. *modeRateControl* selects both sample rate and audio latency. 96-kHz sample rate and low-latency modes can be used together.

rxSubFormat indicates the type and status of audio data being received. The LS bit of this variable indicates whether data in the sub channel is being decoded. A value of 0 indicates inability of the interface to decode the received data. An interface operating at 48 kHz cannot decode 96-kHz audio. An interface operating at 96 kHz cannot decode 48-kHz audio.

Processing 96-kHz audio requires twice the bandwidth. At 5-1/3 ms latency, all of the data is transmitted in one packet and thus the number of channels that can be transferred per bundle may be reduced. Lower latency modes can support more channels at 96 kHz, as the data is distributed across 4 packets at 1-1/3 mS and 2 packets at 2-2/3 ms latency. See [Table 5., "Bundle Capacity Limits as a Function of Ethernet Packet Size"](#) for more detail on this topic.

When operating in 96-kHz mode, the Master Clock remains at the standard 24.576 MHz. However, in 96-kHz mode, the Sample Clock Output (FS1) will change to support a 96-kHz signal. If a sample clock cascade and/or reference clock input is supplied, this signal may be either 48 kHz or 96 kHz in 96-kHz mode but must be 48 kHz in 48-kHz mode.

Table 7. Bit Clock Rates

Synchronous Serial Port Operating Mode	48-kHz SCK Rate	96-kHz SCK Rate
64Fs (2 channels x 4 interfaces)	3.072 MHz	6.144 MHz
128Fs (4 channels x 4 interfaces)	6.144 MHz	12.288 MHz
256Fs (8 channels x 4 interfaces)	12.288 MHz	24.576 MHz

6. Management Interface

The Management Interface (MI) is the means by which the CobraNet interface is controlled and monitored. Integral to the management interface are the MI variables. The MI variables are read and written via the Host Management Interface (HMI) or remotely over the audio network via SNMP. Both methods operate on the same common set of MI variables. The CobraNet device is configured in real time as the variables are changed.

Variables may have read-only, read/write, or read/write-persistent attributes. All variables are given an initial value at startup. The value of all variables can be read. Read/write and Read/write-persistent variable types can be both read and written. The value of persistent variables is saved in flash memory and the variable is restored at startup to the last value written. See [Section 6.2 "Persistence" on page 29](#) for more detail on persistent variables. All MI variables are documented in the [Section 7. "Management Interface Variable Reference" on page 31](#).

MI variables fall into three classes. CobraNet-specific variables allow for configuration and monitoring of CobraNet functionality such as audio transmission and reception. A second class of variables known as SNMP MIB-II variables provides a uniform means of monitoring a network device. These variables are primarily concerned with performance and configuration of the network interface and associated protocols. A third class of product-specific variables may exist when a manufacturer makes use of SNMP extension agent capabilities. This third class of variables is used for controlling and monitoring product-specific features and functions.

6.1 Flash

Flash memory may be updated via TFTP or through HMI. The HMI flash memory access mechanism allows flash contents to be read and written via the host port. This provides functionality for the HMI similar to that which TFTP provides via the network.

The mechanism cannot allow direct access to the flash memory. Instead a request to read or write flash is performed by supplying the flash address (*flashTAddress*), byte length (*flashTLength*), transfer direction (*flashTDirection*), and data (*bridgeTxPktBuffer*). The request is then initiated by writing to *flashTRequest*.

The flash memory is a byte-wide device. On 24-bit CobraNet platforms, the transmit buffer is comprised of 3-byte words. The mapping between the byte-wide flash data and the wider buffer memory is as follows.

Table 8. Flash Layout, 24-bit Platforms

	MS	Middle	LS
First Word	Byte 3	Byte 2	Byte 1
Second Word	Byte 6	Byte 5	Byte 4

On 32-bit CobraNet platforms, the transmit buffer is comprised of 4-byte words. The mapping between the byte-wide flash data and the wider buffer memory is as follows.

Table 9. Flash Layout, 32-bit Platforms

	MS	MH	ML	LS
First Word	Byte 4	Byte 3	Byte 2	Byte 1
Second Word	Byte 8	Byte 7	Byte 6	Byte 5

6.2 Persistence

The persistence feature causes values written to Read/write-persistent type variables to be written to flash and for these stored values to be restored during startup. With the persistence feature disabled, Read/write and Read/write-persistent variables behave identically. Persistence is enabled by setting the *flashPersistEnable* variable.

With persistence enabled, values written to Read/write-persistent variables are written to flash by a background task according to a schedule designed to prevent excessive write cycles on the memory and to avoid interference with other critical functions. In extreme cases it can take up to 1 minute to store changed values. However, the persistence feature is implemented such that it is safe to remove power at any time with the caveat that the values recalled may not include changes made immediately prior to removal of power. Variable values will never become corrupted due to unexpected loss of power or network connection.

flashPersistAck can be used to ensure that variables have been stored to non-volatile memory prior to removal of power.

6.3 Watch Dog

The watch dog is a digital signal from the CobraNet interface provided to allow fault detection. The watch dog signal is toggled periodically by firmware to indicate normal operation. The toggle rate may drop to as low as 5 Hz on occasion, depending on processor load. Actual minimum, maximum, and nominal toggle rates can be found in the Hardware Reference Manual applicable to the particular CobraNet interface. The watch dog signal will stop toggling following detection and reporting of a fatal error condition. The interface should be reset and re-initialized when absence of the watchdog signal is detected.

Use of the watchdog requires external hardware and/or software. A hardware solution may be implemented with a "microprocessor manager" chip such as the DS1236 from Dallas/Maxim. A software solution could involve wiring the watch dog signal to an I/O port, timer, or interrupt on the host processor and then wiring the CobraNet reset signal to a general purpose output. Software on the host processor would monitor the interval between watch dog transitions and assert the reset signal if the interval exceeds the maximum period.

Implementation of the watch dog feature is not mandatory but is recommended. ESD, EMI, and power fluctuation events are not uncommon in audio installations and the ability to survive and recover from such conditions is a prerequisite for passing many electrical certification programs.

6.4 SNMP Extension Agent

CobraNet's SNMP agent feature allows the CobraNet interface to be monitored and configured over the Ethernet network by an SNMP manager (or managers). An enhancement of this capability is the SNMP extension agent which allows these monitoring and control capabilities to be extended to product-specific features and functionality.

SNMP extensions require use of a host processor attached to the CobraNet interface. The extension agent appears to the processor as additional product-specific variables in the HMI memory space. For status reporting, the host microcontroller writes updated values to the associated HMI locations. SNMP requests can then be used to read these values at any time. Extension values can also be written via SNMP and monitored by the host processor in order to provide a control path to the host processor via SNMP.

Extensions implemented along with the appropriate hardware and host software can be used to control and monitor many useful functions. For example, extension variables can be used to remotely monitor metrics such as gain, clipping and temperature. They can also be used to control functions such as gain, noise gates, and compression. The system will also benefit from the persistence feature, allowing settings for the entire product, not just the CobraNet interface, to be retained through a power-cycle.

By using the extension agent, the entire product may be made SNMP manageable without need for the host processor to be burdened with the complexity of running a network stack and SNMP agent.

7. Management Interface Variable Reference

CobraNet interfaces are configured and monitored by reading and writing Management Interface variables. MI variables may be accessed directly via a processor attached to the Host Management Interface or via the network using SNMP. The method of using the HMI is similar for all CobraNet interfaces but may require specific semantics and may have different word sizes depending on the actual implementation. The HMI interface is described in more detail in the Hardware Reference Manual applicable to the particular CobraNet Interface. Following are detailed descriptions of the size, contents, and effects of the MI variables as well as their HMI addresses and SNMP Object Identifier numbers. All MI variables can be accessed via the HMI but some variable properties render them inappropriate for accessing via SNMP. These exceptions are noted in the variable descriptions where applicable.

7.1 Legend

Name - Name of variable as seen in CobraNet MIB and cobrami.h header file.

Description - Description of the variable including allowed values and usage discussion.

Host Address - HMI addresses are used to access variables via the host port. HMI addresses have a 24-bit range on both 24- and 32-bit platforms.

SNMP Object ID (OID)- The Object Identifier is the numeric name assigned to a variable according to the SNMP protocol.

Size - Size is indicated for varying-length data types such as *DisplayString* and *OID*. Size is not indicated for fixed types whose size is implied by their data type. Note that for fixed types, the word size may differ depending on the processor type.

Count - Number of entries for array or buffer-type variables. Absence of a *Count* specification implies a single instance variable, and thus a *Count* of 1.

Type - Data type of the variable. The options and format of data types are described below in detail.

Attributes - **Read-only** variables can only be read and can not be modified. **Read/Write** variables can be read and written. **Read/Write - Persistent** variables can be read and written. If the persistence feature is enabled, values of these variables will automatically be written to flash for recall at startup.

Default - Value assigned to the variable at startup when persistence is disabled. The values of some Read-only variables reflect system conditions and thus may not have a default value.

Version - Firmware version in which the variable was first introduced. Unless otherwise noted in this field, one can assume variables will be available in the version indicated and all subsequent versions.

7.2 Data Types

7.2.1 *DisplayString*

A *DisplayString* is an ASCII string comprised entirely of printable characters.

24-bit HMI: The first word indicates the length of the string in characters. Data is stored three characters per 24-bit word. Character order is MS, Middle, LS. For *DisplayString* variables, documented *Size* indicates the largest possible word size of the variable. *Size* includes the length field. The maximum allowable characters for a *DisplayString* variable is $(Size-1) \times 3$.

32-bit HMI: The first word indicates the length of the string in characters. Data is stored four characters per 32-bit word. Character order is MS, MH, ML, LS. For *DisplayString* variables, documented *Size* indicates the largest possible word size of the variable. *Size* includes the length field. The maximum allowable characters for a *DisplayString* variable is $(Size-1) \times 4$.

7.2.2 OID

An SNMP object identifier is the numeric name of an SNMP variable. OIDs are also used for other purposes including system-unique identifiers.

24-bit HMI: OIDs are presented in their native BER encoding. The first word indicates the length of the encoding in bytes. Data is stored three octets per 24-bit word. Character order is MS, Middle, LS. For *OID* variables documented *Size* indicates the largest possible word size for the variable. *Size* includes the length field. The maximum number of octets for the *OID* variable encoding is $(Size-1) \times 3$.

32-bit HMI: OIDs are presented in their native BER encoding. The first word indicates the length of the encoding in bytes. Data is stored four octets per 32-bit word. Character order is MS, MH, ML, LS. For *OID* variables documented *Size* indicates the largest possible word size for the variable. *Size* includes the length field. The maximum number of octets for the *OID* variable encoding is $(Size-1) \times 4$.

7.2.3 IpAddress

An *IpAddress* is a 32-bit internet protocol (IP) address.

24-bit HMI: Data is stored in the most-significant 16 bits of 2 consecutive 24-bit words as shown in [Table 10](#). The least-significant 8 bits of each location are read as zero and *must* be written as zero.

Table 10. IP address Layout, 24-bit Platforms

	MS	Middle	LS
Word 1	IP address byte 2	IP address byte 1	0
Word 2	IP address byte 4	IP address byte 3	0

32-bit HMI: Data is stored in a single 32-bit word as illustrated below.

Table 11. IP address Layout, 32-bit Platforms

MS	MH	ML	LS
IP address byte 2	IP address byte 1	IP address byte 4	IP address byte 3

7.2.4 PhysAddress

A 48-bit Ethernet media access control (MAC) address.

24-bit HMI: Data is stored in the most-significant 16 bits of 3 consecutive memory locations as illustrated below. The least-significant 8 bits of each location are read as zero and *must* be written as zero.

Table 12. MAC address Layout, 24-bit Platforms

	MS	Middle	LS
Word 1	MAC byte 2	MAC byte 1	0
Word 2	MAC byte 4	MAC byte 3	0
Word 3	MAC byte 6	MAC byte 5	0

32-bit HMI: Data is stored in two consecutive words as shown below. A third word is unused and reserved for addressing compatibility with 24-bit platforms.

Table 13. MAC address Layout, 32-bit Platforms

	MS	MH	ML	LS
Word 1	MAC byte 2	MAC byte 1	MAC byte 4	MAC byte 3
Word 2	MAC byte 6	MAC byte 5	unused	unused
Word 3	unused	unused	unused	unused

7.2.5 TimeTicks

TimeTicks is an integer encoding for time durations in units of 100ths of a second.

24-bit HMI: An unsigned timer value is available in two successive 24-bit words. A 32-bit timer value and 15-bit fractional extension are available as shown below. The fractional extension may be used to gain additional accuracy. It may be safely ignored for most applications.

Table 14. TimeTicks Layout, 24-bit Platforms

	MS	Middle	LS
Word 1	Timer MS	Timer MH	Timer ML
Word 2	Timer LS	Fractional LS	Fractional MS

32-bit HMI: *TimeTicks* value is available as two successive 32-bit words. A 32-bit timer value, a 16-bit rollover, and 16-bit fractional extension are available as shown below. The fractional extension may be used to gain additional accuracy. The rollover extension may be used to extend the useful range of the timer. Both may be safely ignored for most applications.

Table 15. TimeTicks Layout, 32-bit Platforms

	MS	MH	ML	LS
Word 1	Rollover MS	Rollover LS	Timer MS	Timer MH
Word 2	Timer ML	Timer LS	Fractional LS	Fractional MS

SNMP: *TimeTicks* is reported as a 32-bit integer in units of 100ths of a second. For example, a reported value of 1000 indicates a 10-second timer reading. As seen through SNMP, *TimeTicks* variables roll over after 2^{32} 100ths of a second (42,949,672.96 seconds - over one year).

7.2.6 Counter

Counters are never writable and cannot be reset. They indicate the count value since the interface was last restarted (*sysUpTime* = 0). Counters roll over to zero after reaching their maximum value of 2^{24} (16,777,216) on 24-bit platforms and 2^{32} (4,294,967,296) on 32-bit platforms.

24-bit HMI: Counter value is represented as a single 24-bit word.

32-bit HMI: Counter value is represented as a single 32-bit word.

7.2.7 Counter2

Counter2 is specific to 24-bit platforms and is a 48-bit unsigned event counter. *Counter2* rolls over after 2^{48} counts. Counters are never writable. **On 32-bit platforms *Counter2* is identical to the *Counter* type.**

24-bit HMI: The counter value is stored in two successive memory locations. The most-significant word appears first. It is suggested that one read the MS word followed by LS word followed by a second read of the MS word and verify that the MS word has not changed during the LS read (if so, start over).

32-bit HMI: Counter value is represented in the same single 32-bit word used for the *Counter* type.

SNMP: Only the least-significant 32-bits of the counter value are reported. The counter appears to wrap at 2^{32} and conforms to the expected behavior for the standard SNMP *Counter* data type.

7.2.8 Integer

A single-precision, signed integer. Valid range is -2^{23} (-8,388,608) to $2^{23}-1$ (8,388,607) on 24-bit platforms and -2^{31} (-2,147,483,648) to $2^{31}-1$ (2,147,483,647) on 32-bit platforms.

HMI: Signed data is represented in a single word in 2's complement form.

SNMP: On 24-bit platforms, *Bad Value* error may be reported if the value magnitude exceeds the 24-bit signed integer range on a set operation.

7.2.9 Integer16

A signed, 16-bit integer. Valid range is -2^{15} (-32,768) to $2^{15}-1$ (32,767).

24-bit HMI: Signed data is represented in 2's complement form. *The most significant 16 bits of the 24-bit host data contain the significant bits.* The LS 8 bits are read as zero and must be written as zero.

32-bit HMI: Same as 32-bit *Integer* type with useful values less than 2^{16} (65,536).

SNMP: *Bad Value* may be reported if value magnitude exceeds 2^{16} on a set operation.

7.2.10 Integer48

Integer48 is specific to 24-bit platforms. This type is a signed, 48-bit integer. **On 32-bit platforms *Integer48* is identical to the *Integer* type.**

24-bit HMI: Data is stored in 2 consecutive memory locations. The most significant word appears first. Signed data is represented in 2's complement form.

32-bit HMI: Signed data is represented as the single word in 2's complement form used for the *Integer* type.

SNMP: Only the least-significant 32-bits of the value is reported.

7.3 MIB-II Variables

These variables are common to all SNMP implementations. This common set of management variables is defined in the Internet Engineering Task Force (IETF) standards document RFC 1213.

7.3.1 System

Name	sysDescr
Description	<p>Describes type of interface as ASCII text.</p> <p>Format for 24-bit platforms: <product specific description> CobraNet version <protocol version>.<major version>.<minor version>[.<manufacturer version>] <hardware platform> rev <hardware rev></p> <p>Format for 32-bit platforms: <product specific description> CobraNet version <protocol version>.<major version>.<minor version>[.<manufacturer version>] <hardware platform><hardware rev></p> <p>Format for RAVE platforms: <product specific description> CobraNet version <protocol version>.<major version>.<minor version>[.<manufacturer version>]</p> <p>NOTE: [.<manufacturer version>] is an additional manufacturer-specific string that can be optionally added to the firmware by Cirrus Logic for 24-bit platforms or added by the OEM using the <i>CNCustom</i> program for 32-bit platforms. Example for CS18101: Cirrus Logic EV-2/CM-2 (CM18101) CobraNet version 2.10.5 CS181012</p>
Host Address	0x100000
SNMP Object ID	1.3.6.1.2.1.1.1
Size	78 characters for 24-bit platforms. 80 characters for CS181xx-based platforms.
Type	DisplayString
Attributes	Read-only
Default Value	"[manufacturer name] [product name] CobraNet firmware [protocol version].[major version].[minor version].[manufacturer's version (optional, see note above)]"
Implemented Version	2.9.10, 2.10.5

Name	sysObjectID
Description	The vendor's authoritative identification of the network management subsystem contained in the entity. This value is allocated within the SMI enterprise sub-tree (1.3.6.1.4.1) and provides an easy and unambiguous means for determining `what kind of box' is being managed. For example, if vendor `Cirrus Logic' was assigned the sub-tree 1.3.6.1.4.1.2680, the identifier `CM-2' could be assigned to 1.3.6.1.4.1.2680.1.2.1.1
Host Address	0x100100
SNMP Object ID	1.3.6.1.2.1.1.2
Size	60 characters
Type	OID
Attributes	Read-only
Default Value	1.3.6.1.4.1.2680.1.2.(CobraNet manufacturer ID).(manufacturer product ID)
Implemented Version	2.6.3

Name	sysContact
Description	The identification of the contact person for this managed node, together with information on how to contact this person.
Host Address	0x100200
SNMP Object ID	1.3.6.1.2.1.1.4
Size	60 characters
Type	DisplayString
Attributes	Read/write - Persistent
Default Value	Zero length string
Implemented Version	2.6.3

Name	sysName
Description	A name assigned to this managed node. By convention, this is the node's fully qualified domain name.
Host Address	0x100300
SNMP Object ID	1.3.6.1.2.1.1.5
Size	60 characters
Type	DisplayString
Attributes	Read/write - Persistent
Default Value	Product specific
Implemented Version	2.6.3

Name	sysLocation
Description	The physical location of this node (e.g., "telephone closet, 3rd floor")
Host Address	0x100400
SNMP Object ID	1.3.6.1.2.1.1.6
Size	60 characters
Type	DisplayString
Attributes	Read/write - Persistent
Default Value	Zero length string
Implemented Version	2.6.3

Name	sysUpTime
Description	Time in 100ths of a second since the network management portion of the system was last re-initialized.
Host Address	0x100500
SNMP Object ID	1.3.6.1.2.1.1.3
Type	TimeTicks
Attributes	Read-only
Default Value	0
Implemented Version	2.6.3

Name	sysServices
Description	A value which indicates the set of services supported by this entity. The value is a sum. This sum initially takes the value zero, For each layer, L, in the range 1 through 7, that this node performs transactions for, 2 raised to (L - 1) is added. For example, a node which performs primarily routing functions would have a value of 4 which is equal to $(2^{(3-1)})$. A node which is a host offering application services would have a value of 72 or $(2^{(4-1)} + 2^{(7-1)})$. In the context of the Internet suite of protocols, the following service layers are commonly supported: 1 physical (e.g., repeaters), 2 datalink/subnetwork (e.g., bridges), 3 internet (e.g., IP gateways), 4 end-to-end (e.g., IP hosts), 7 applications (e.g., mail relays). For systems including OSI protocols, layers 5 and 6 may also be counted.
Host Address	0x100502
SNMP Object ID	1.3.6.1.2.1.1.7
Type	Integer
Attributes	Read-only
Default Value	72
Implemented Version	2.6.3

7.3.2 Interface

Name	ifNumber
Description	The number of network interfaces (regardless of their current state) present on this system.
Host Address	0x110000
SNMP Object ID	1.3.6.1.2.1.2.1
Type	Integer
Attributes	Read-only
Default Value	1
Implemented Version	2.1.0

Name	ifDescr
Description	A string containing information about the interface. This string should include the name of the manufacturer, the product name and the version of the hardware interface.
Host Address	0x110001
SNMP Object ID	1.3.6.1.2.1.2.2.1.2
Size	Up to 60 characters.
Type	DisplayString
Attributes	Read-only
Default Value	"CobraNet"
Implemented Version	2.1.0

Name	ifType
Description	The type of interface, distinguished according to the physical/link protocol(s) immediately 'below' the network layer in the protocol stack. Reference RFC 1213 for all type identifiers
Host Address	0x11000A
SNMP Object ID	1.3.6.1.2.1.2.2.1.3
Type	Integer
Attributes	Read-only
Default Value	7
Implemented Version	2.1.0

Name	ifMtu
Description	The size of the largest datagram or 'packet' that can be sent/received by the interface, specified in octets. For interfaces that are used for transmitting network datagrams, this is the size of the largest network datagram that can be sent on the interface.
Host Address	0x11000B
SNMP Object ID	1.3.6.1.2.1.2.2.1.4
Type	Integer
Attributes	Read-only
Default Value	1500
Implemented Version	2.1.0

Name	ifSpeed
Description	An estimate of the interface's current bandwidth in bits per second or Mbits per second (see Notes below). For interfaces which do not vary in bandwidth or for those where no accurate estimation can be made, this object should contain the nominal bandwidth.
Host Address	0x11000C
SNMP Object ID	1.3.6.1.2.1.2.2.1.5
Type	Integer
Attributes	Read-only
Default Value	100
Implemented Version	2.1.0, corrected is 2.6.5 (see Notes below)
Notes	Prior to CobraNet firmware version 2.6.5, <i>ifSpeed</i> was incorrectly reported via SNNP in Mbit/second units (100Mbit interface <i>ifSpeed</i> reported as "100"). 2.6.5 correctly reports <i>ifSpeed</i> in bits per second units via SNMP but due to space constraints, <i>ifSpeed</i> is still reported in Mbit per second units via HMI on 24-bit platforms. <i>ifSpeed</i> is reported consistently in bits per second units on 32-bit platforms.

Name	ifPhysAddress
Description	The interface's address at the protocol layer immediately 'below' the network layer in the protocol stack.
Host Address	0x11000D
SNMP Object ID	1.3.6.1.2.1.2.2.1.6
Type	PhysAddress
Attributes	Read-only
Default Value	n.a.
Implemented Version	2.1.0

Name	ifAdminStatus
Description	The desired state of the interface. The testing(3) state indicates that no operational packets can be passed up(1) -- ready to pass packets down(0)
Host Address	0x111000
SNMP Object ID	1.3.6.1.2.1.2.2.1.7
Type	Integer
Attributes	Read/Write
Default Value	1
Implemented Version	2.1.0

Name	ifOperStatus
Description	The current operational state of the interface. The testing(3) state indicates that no operational packets can be passed. up(1) - ready to pass packets down(0)
Host Address	0x112000
SNMP Object ID	1.3.6.1.2.1.2.2.1.8
Type	Integer
Attributes	Read-only
Default Value	1
Implemented Version	2.1.0

Name	ifLastChange
Description	The value of <i>sysUpTime</i> at the time the interface entered its current operational state. If the current state was entered prior to the last re- initialization of the local network management subsystem, then this object contains a zero value.
Host Address	0x112001
SNMP Object ID	1.3.6.1.2.1.2.2.1.9
Type	TimeTicks
Attributes	Read-only
Default Value	n.a.
Implemented Version	2.1.0

Name	ifInOctets
Description	The total number of octets received on the interface, including framing characters.
Host Address	0x112016
SNMP Object ID	1.3.6.1.2.1.2.2.1.10
Type	Counter48
Attributes	Read-only
Default Value	0
Implemented Version	2.1.0

Name	ifInUcastPkts
Description	The number of subnetwork-unicast packets delivered to a higher-layer protocol.
Host Address	0x112018
SNMP Object ID	1.3.6.1.2.1.2.2.1.11
Type	Counter
Attributes	Read-only
Default Value	0
Implemented Version	2.1.0

Name	ifInNUcastPkts
Description	The number of non-unicast (i.e., subnetwork- broadcast or subnetwork-multicast) packets delivered to a higher-layer protocol.
Host Address	0x112019
SNMP Object ID	1.3.6.1.2.1.2.2.1.12
Type	Counter
Attributes	Read-only
Default Value	0
Implemented Version	2.1.0

Name	ifInDiscards
Description	The number of inbound packets which were chosen to be discarded even though no errors had been detected to prevent their delivery to a higher-layer protocol. One possible reason for discarding such a packet could be lack of buffer space.
Host Address	0x11201A
SNMP Object ID	1.3.6.1.2.1.2.2.1.13
Type	Counter
Attributes	Read-only
Default Value	0
Implemented Version	2.1.0

Name	ifInErrors
Description	The number of inbound packets that contained errors preventing delivery to a higher-layer protocol.
Host Address	0x11201B
SNMP Object ID	1.3.6.1.2.1.2.2.1.14
Type	Counter
Attributes	Read-only
Default Value	0
Implemented Version	2.1.0

Name	ifInUnknownProtos
Description	The number of packets received which were discarded due to an unknown or unsupported protocol.
Host Address	0x11201C
SNMP Object ID	1.3.6.1.2.1.2.2.1.15
Type	Counter
Attributes	Read-only
Default Value	0
Implemented Version	2.1.0

Name	ifOutOctets
Description	The total number of octets transmitted by the interface, including framing characters.
Host Address	0x11201D - 0x11201E
SNMP Object ID	1.3.6.1.2.1.2.2.1.16
Type	Counter48
Attributes	Read-only
Default Value	0
Implemented Version	2.1.0

Name	ifOutUcastPkts
Description	The total number of packets that higher-level protocols requested be transmitted to a subnetwork-unicast address, including those that were discarded or not sent.
Host Address	0x11201F
SNMP Object ID	1.3.6.1.2.1.2.2.1.17
Type	Counter
Attributes	Read-only
Default Value	0
Implemented Version	2.1.0

Name	ifOutNUcastPkts
Description	The total number of packets that higher-level protocols requested be transmitted to a non-unicast (i.e., a subnetwork-broadcast or subnetwork-multicast) address, including those that were discarded or not sent.
Host Address	0x112020
SNMP Object ID	1.3.6.1.2.1.2.2.1.18
Type	Counter
Attributes	Read-only
Default Value	0
Implemented Version	2.1.0

Name	ifOutDiscards
Description	The number of outbound packets which were chosen to be discarded even though no errors had been detected to prevent their transmission. One possible reason for discarding such a packet could be to free up buffer space.
Host Address	0x112021
SNMP Object ID	1.3.6.1.2.1.2.2.1.19
Type	Counter
Attributes	Read-only
Default Value	0
Implemented Version	2.1.0

Name	ifOutErrors
Description	The number of outbound packets that could not be transmitted due to errors.
Host Address	0x112022
SNMP Object ID	1.3.6.1.2.1.2.2.1.20
Type	Counter
Attributes	Read-only
Default Value	0
Implemented Version	2.1.0

Name	ifOutQLen
Description	The length of the output packet queue (in packets)
Host Address	0x112023
SNMP Object ID	1.3.6.1.2.1.2.2.1.21
Type	Integer
Attributes	Read-only
Default Value	n.a.
Implemented Version	2.6.1

Name	ifSpecific
Description	A reference to MIB definitions specific to the particular media being used to implement the interface. For example, if the interface is implemented by Ethernet, then the value of this object refers to a document defining objects specific to Ethernet. If this information is not present, its value should be set to the OBJECT IDENTIFIER { 0 0 }, which is a syntactically valid object identifier, and any conformant implementation of ASN.1 and BER must be able to generate and recognize this value.
Host Address	0x112024
SNMP Object ID	1.3.6.1.2.1.2.2.1.22
Size	2
Type	OID
Attributes	Read-only
Default Value	0.0
Implemented Version	2.6.1

7.3.3 Address Translation

The Address Translations are deprecated. These variables are no longer available via SNMP.

Name	atIfIndex
Description	The interface on which this entry's equivalence is effective. The interface identified by a particular value of this index is the same interface as identified by the same value of <i>ifIndex</i> .
Host Address	0x120000
SNMP Object ID	Not available via SNMP
Type	Integer
Attributes	Read-only
Default Value	1
Implemented Version	2.1.0

Name	atPhysAddress
Description	MAC address of the device. Use of <i>ifPhysAddress</i> is preferred for determining the MAC address.
Host Address	0x120001
SNMP Object ID	Not available via SNMP
Type	PhysAddress
Attributes	Read-only
Default Value	As assigned by manufacturer
Implemented Version	2.1.0

Name	atNetAddress
Description	IP address of the device. Obtaining the IP address via SNMP should not be a necessary operation - you need to know the IP address in order to send the query. Via HMI, the IP address may be monitored and manipulated via the IP Monitor variables.
Host Address	0x120004
SNMP Object ID	Not available via SNMP
Type	IpAddress
Attributes	Read-only
Default Value	As assigned by RARP, BOOTP or IP monitor variables.
Implemented Version	2.1.0

7.3.4 IP

Name	ipForwarding
Description	The indication of whether this entity is acting as an IP gateway to forward of datagrams received by, but not addressed to, this entity. IP gateways forward datagrams. IP hosts do not (except those source-routed via the host).
Host Address	0x130000
SNMP Object ID	1.3.6.1.2.1.4.1
Type	Integer
Attributes	Read/Write
Default Value	Always reads 2
Implemented Version	2.6.0

Name	ipDefaultTTL
Description	The default value inserted into the Time-To-Live field of the IP header of datagrams originated at this entity when a TTL value is not supplied by the transport layer protocol.
Host Address	0x130001
SNMP Object ID	1.3.6.1.2.1.4.2
Type	Integer
Attributes	Read/Write
Default Value	128
Implemented Version	2.6.0

Name	ipInReceives
Description	The total number of input datagrams received, including those received in error.
Host Address	0x131000
SNMP Object ID	1.3.6.1.2.1.4.3
Type	Counter
Attributes	Read-only
Default Value	0
Implemented Version	2.6.0

Name	ipInHdrErrors
Description	The number of input datagrams discarded due to errors in their IP headers, including bad checksums, version number mismatch, other format errors, time-to-live exceeded, errors discovered in processing their IP options, etc.
Host Address	0x131001
SNMP Object ID	1.3.6.1.2.1.4.4
Type	Counter
Attributes	Read-only
Default Value	0
Implemented Version	2.6.0

Name	ipInAddrErrors
Description	The number of input datagrams discarded because the IP address in the IP header's destination field was not a valid address to be received at this entity. This count includes invalid addresses (e.g., 0.0.0.0) and addresses of unsupported Classes (e.g., Class E). For entities which are not IP Gateways and therefore do not forward datagrams, this counter includes datagrams discarded because the destination address was not a local address.
Host Address	0x131002
SNMP Object ID	1.3.6.1.2.1.4.5
Type	Counter
Attributes	Read-only
Default Value	0
Implemented Version	2.6.0

Name	ipForwDatagrams
Description	The number of input datagrams for which this entity was not the final IP destination, as a result of which an attempt was made to find a route to forward them to the final destination. In entities which do not act as IP Gateways, this counter will include only those packets which were Source-Routed via this entity, and the Source-Route option processing was successful.
Host Address	Not available
SNMP Object ID	1.3.6.1.2.1.4.6
Type	Counter
Attributes	Read-only
Default Value	0
Implemented Version	2.6.0

Name	ipInUnknownProtos
Description	The number of locally-addressed datagrams received successfully but discarded because of an unknown or unsupported protocol.
Host Address	0x131003
SNMP Object ID	1.3.6.1.2.1.4.7
Type	Counter
Attributes	Read-only
Default Value	0
Implemented Version	2.6.0

Name	ipInDiscards
Description	The number of IP datagrams received successfully but which were discarded (e.g., for lack of buffer space). Note that this counter does not include datagrams discarded while awaiting re-assembly.
Host Address	0x131004
SNMP Object ID	1.3.6.1.2.1.4.8
Type	Counter
Attributes	Read-only
Default Value	0
Implemented Version	2.6.0

Name	ipInDelivers
Description	The total number of input datagrams successfully delivered to IP user-protocols (including ICMP)
Host Address	0x131005
SNMP Object ID	1.3.6.1.2.1.4.9
Type	Counter
Attributes	Read-only
Default Value	0
Implemented Version	2.6.0

Name	ipOutRequests
Description	The total number of IP datagrams which local IP user-protocols (including ICMP) supplied to IP in requests for transmission. Note that this does not include datagrams counted in <i>ipForwDatagrams</i> .
Host Address	0x131006
SNMP Object ID	1.3.6.1.2.1.4.10
Type	Counter
Attributes	Read-only
Default Value	0
Implemented Version	2.6.0

Name	ipOutDiscards
Description	The number of IP datagrams for which no problem existed to prevent their transmission, but which were discarded (e.g., for lack of buffer space). Note that this counter would include datagrams counted in <i>ipForwDatagrams</i> if any such packets met this (discretionary) discard criterion.
Host Address	Not available
SNMP Object ID	1.3.6.1.2.1.4.11
Type	Counter
Attributes	Read-only
Default Value	0
Implemented Version	2.6.0

Name	ipOutNoRoutes
Description	The number of IP datagrams discarded because no route could be found to transmit them to their destination. Note that this counter includes packets counted in <i>ipForwDatagrams</i> which meet this 'no-route' criterion. This includes any datagrams which cannot route because all of its default gateways are down.
Host Address	Not available
SNMP Object ID	1.3.6.1.2.1.4.12
Type	Counter
Attributes	Read-only
Default Value	0
Implemented Version	2.6.0

Name	ipReasmTimeout
Description	The maximum number of seconds which received fragments are held while they are awaiting reassembly.
Host Address	Not available
SNMP Object ID	1.3.6.1.2.1.4.13
Type	Integer
Attributes	Read-only
Default Value	0
Implemented Version	2.6.0

Name	ipReasmReqds
Description	The number of IP fragments received which needed to be reassembled.
Host Address	0x131007
SNMP Object ID	1.3.6.1.2.1.4.14
Type	Counter
Attributes	Read-only
Default Value	0
Implemented Version	2.6.0

Name	ipReasmOKs
Description	The number of IP datagrams successfully re-assembled.
Host Address	Not available
SNMP Object ID	1.3.6.1.2.1.4.15
Type	Counter
Attributes	Read-only
Default Value	0
Implemented Version	2.6.0

Name	ipReasmFails
Description	The number of failures detected by the IP re-assembly algorithm (for whatever reason: timed out, errors, etc). Note that this is not necessarily a count of discarded IP fragments since some algorithms (notably the algorithm in RFC 815) can lose track of the number of fragments by combining them as they are received. This value will always increment on receipt of a fragmented packet as CobraNet does not support packet re-assembly
Host Address	0x131007 (same as ipReasmReqs)
SNMP Object ID	1.3.6.1.2.1.4.16
Type	Counter
Attributes	Read-only
Default Value	0
Implemented Version	2.6.0

Name	ipFragOKs
Description	The number of IP datagrams that have been successfully fragmented at this entity. The CobraNet interface does not support fragmentation. This variable will always read 0.
Host Address	Not available
SNMP Object ID	1.3.6.1.2.1.4.17
Type	Counter
Attributes	Read-only
Default Value	0
Implemented Version	2.6.0

Name	ipFragFails
Description	The number of IP datagrams that have been discarded because they needed to be fragmented at this entity but could not be, e.g., because their Don't Fragment flag was set. The CobraNet interface does not support fragmentation. This variable will always read 0.
Host Address	Not available
SNMP Object ID	1.3.6.1.2.1.4.18
Type	Counter
Attributes	Read-only
Default Value	0
Implemented Version	2.6.0

Name	ipFragCreates
Description	The number of IP datagram fragments that have been generated as a result of fragmentation at this entity. The CobraNet interface does not support fragmentation. This variable will always read 0.
Host Address	Not available
SNMP Object ID	1.3.6.1.2.1.4.19
Type	Counter
Attributes	Read-only
Default Value	0
Implemented Version	2.6.0

Name	ipRoutingDiscards
Description	The number of routing entries which were chosen to be discarded even though they are valid. One possible reason for discarding such an entry could be to free-up buffer space for other routing entries. The CobraNet interface does not support routing. This variable will always read 0.
Host Address	Not available
SNMP Object ID	1.3.6.1.2.1.4.23
Type	Counter
Attributes	Read-only
Default Value	0
Implemented Version	2.6.0

7.3.5 UDP

Name	udpInDatagrams
Description	The total number of UDP datagrams delivered to UDP users.
Host Address	0x140000
SNMP Object ID	1.3.6.1.2.1.7.1
Type	Counter
Attributes	Read-only
Default Value	0
Implemented Version	2.6.0

Name	udpNoPorts
Description	The total number of received UDP datagrams for which there was no application at the destination port.
Host Address	0x140001
SNMP Object ID	1.3.6.1.2.1.7.2
Type	Counter
Attributes	Read-only
Default Value	0
Implemented Version	2.6.0

Name	udpInErrors
Description	The number of received UDP datagrams that could not be delivered for reasons other than lack of an application at the destination port.
Host Address	0x140002
SNMP Object ID	1.3.6.1.2.1.7.3
Type	Counter
Attributes	Read-only
Default Value	0
Implemented Version	2.6.0

Name	udpOutDatagrams
Description	The total number of UDP datagrams sent from this entity.
Host Address	0x140003
SNMP Object ID	1.3.6.1.2.1.7.4
Type	Counter
Attributes	Read-only
Default Value	0
Implemented Version	2.6.0

Name	udpLocalAddress
Description	The local IP address for this UDP listener. In the case of a UDP listener which is willing to accept datagrams for any IP interface associated with the node, the value 0.0.0.0 is used.
Host Address	N.A.
SNMP Object ID	N.A.
Type	IpAddress
Attributes	Read-only
Default Value	N.A.
Implemented Version	Not supported

Name	udpLocalPort
Description	The local port number for this UDP listener.
Host Address	N.A.
SNMP Object ID	N.A.
Type	Integer16
Attributes	Read-only
Default Value	N.A.
Implemented Version	Not supported

7.3.6 SNMP

Name	snmpInPkts
Description	The total number of SNMP Messages received from the transport service
Host Address	0x150000
SNMP Object ID	1.3.6.1.2.1.11.1
Type	Counter
Attributes	Read-only
Default Value	0
Implemented Version	2.6.0

Name	snmpOutPkts
Description	The total number of SNMP Messages passed to the transport service.
Host Address	0x150001
SNMP Object ID	1.3.6.1.2.1.11.2
Type	Counter
Attributes	Read-only
Default Value	0
Implemented Version	2.6.0

Name	snmpInBadVersions
Description	The total number of SNMP Messages received which were for an unsupported SNMP version.
Host Address	0x150002
SNMP Object ID	1.3.6.1.2.1.11.3
Type	Counter
Attributes	Read-only
Default Value	0
Implemented Version	2.6.0

Name	snmpInBadCommunityNames
Description	The total number of SNMP Messages received which used an unknown community name.
Host Address	0x150003
SNMP Object ID	1.3.6.1.2.1.11.4
Type	Counter
Attributes	Read-only
Default Value	0
Implemented Version	2.6.0

Name	snmpInBadCommunityUses
Description	The total number of SNMP Messages received for which an operation was not allowed by the SNMP community named in the Message.
Host Address	0x150004
SNMP Object ID	1.3.6.1.2.1.11.5
Type	Counter
Attributes	Read-only
Default Value	0
Implemented Version	2.6.0

Name	snmpInASNParseErrs
Description	The total number of ASN.1 or BER errors encountered when decoding received SNMP Messages.
Host Address	0x150005
SNMP Object ID	1.3.6.1.2.1.11.6
Type	Counter
Attributes	Read-only
Default Value	0
Implemented Version	2.6.0

Name	snmpInTooBig
Description	The total number of SNMP PDUs received for which the value of the error-status field was `tooBig`.
Host Address	Not available
SNMP Object ID	1.3.6.1.2.1.11.8
Type	Counter
Attributes	Read-only
Default Value	Always reads 0
Implemented Version	2.6.0

Name	snmpInNoSuchNames
Description	The total number of SNMP PDUs received for which the value of the error-status field was `noSuchName`.
Host Address	Not available
SNMP Object ID	1.3.6.1.2.1.11.9
Type	Counter
Attributes	Read-only
Default Value	Always reads 0
Implemented Version	2.6.0

Name	snmpInBadValues
Description	The total number of SNMP PDUs received for which the value of the error-status field was `badValue`.
Host Address	Not available
SNMP Object ID	1.3.6.1.2.1.11.10
Type	Counter
Attributes	Read-only
Default Value	Always reads 0
Implemented Version	2.6.0

Name	snmplnReadOnlys
Description	The total number of valid SNMP PDUs received for which the value of the error-status field was `readOnly`. Note that it is a protocol error to generate an SNMP PDU which contains the value `readOnly` in the error-status field. This object is provided as a means of detecting incorrect implementations of SNMP.
Host Address	Not available
SNMP Object ID	1.3.6.1.2.1.11.11
Type	Counter
Attributes	Read-only
Default Value	Always reads 0
Implemented Version	2.6.0

Name	snmplnGenErrs
Description	The total number of SNMP PDUs received for which the value of the error-status field was `genErr`.
Host Address	Not Available
SNMP Object ID	1.3.6.1.2.1.11.12
Type	Counter
Attributes	Read-only
Default Value	Always reads 0
Implemented Version	2.6.0

Name	snmplnTotalReqVars
Description	The total number of MIB objects which have been retrieved successfully as a result of receiving valid SNMP Get-Request and Get-Next PDUs.
Host Address	0x150006
SNMP Object ID	1.3.6.1.2.1.11.13
Type	Counter
Attributes	Read-only
Default Value	0
Implemented Version	2.6.0

Name	snmplnTotalSetVars
Description	The total number of MIB objects which have been altered successfully as a result of receiving valid SNMP Set-Request PDUs.
Host Address	0x150007
SNMP Object ID	1.3.6.1.2.1.11.14
Type	Counter
Attributes	Read-only
Default Value	0
Implemented Version	2.6.0

Name	snmplnGetRequests
Description	The total number of SNMP Get-Request PDUs which have been accepted and processed.
Host Address	0x150008
SNMP Object ID	1.3.6.1.2.1.11.15
Type	Counter
Attributes	Read-only
Default Value	0
Implemented Version	2.6.0

Name	snmplnGetNexts
Description	The total number of SNMP Get-Next PDUs which have been accepted and processed.
Host Address	0x150009
SNMP Object ID	1.3.6.1.2.1.11.16
Type	Counter
Attributes	Read-only
Default Value	0
Implemented Version	2.6.3

Name	snmpInSetRequests
Description	The total number of SNMP Set-Request PDUs which have been accepted and processed.
Host Address	0x15000A
SNMP Object ID	1.3.6.1.2.1.11.17
Type	Counter
Attributes	Read-only
Default Value	0
Implemented Version	2.6.3

Name	snmpInGetResponses
Description	The total number of SNMP Get-Response PDUs which have been accepted and processed.
Host Address	Not available
SNMP Object ID	1.3.6.1.2.1.11.18
Type	Counter
Attributes	Read-only
Default Value	Always reads 0
Implemented Version	2.6.3

Name	snmpInTraps
Description	The total number of SNMP Trap PDUs which have been accepted and processed.
Host Address	Not available
SNMP Object ID	1.3.6.1.2.1.11.19
Type	Counter
Attributes	Read-only
Default Value	Always reads 0
Implemented Version	2.6.3

Name	snmpOutTooBig
Description	The total number of SNMP PDUs generated for which the value of the error-status field was 'tooBig.'
Host Address	0x15000B
SNMP Object ID	1.3.6.1.2.1.11.20
Type	Counter
Attributes	Read-only
Default Value	0
Implemented Version	2.6.3

Name	snmpOutNoSuchNames
Description	The total number of SNMP PDUs generated for which the value of the error-status was 'noSuchName'.
Host Address	0x15000C
SNMP Object ID	1.3.6.1.2.1.11.21
Type	Counter
Attributes	Read-only
Default Value	0
Implemented Version	2.6.3

Name	snmpOutBadValues
Description	The total number of SNMP PDUs generated for which the value of the error-status field was 'badValue'.
Host Address	0x15000D
SNMP Object ID	1.3.6.1.2.1.11.22
Type	Counter
Attributes	Read-only
Default Value	0
Implemented Version	2.6.3

Name	snmpOutGenErrs
Description	The total number of SNMP PDUs generated for which the value of the error-status field was 'genErr'.
Host Address	0x15000E
SNMP Object ID	1.3.6.1.2.1.11.24
Type	Counter
Attributes	Read-only
Default Value	0
Implemented Version	2.6.3

Name	snmpOutGetRequests
Description	The total number of SNMP Get-Request PDUs generated.
Host Address	Not available
SNMP Object ID	1.3.6.1.2.1.11.25
Type	Counter
Attributes	Read-only
Default Value	Always reads 0
Implemented Version	2.6.3

Name	snmpOutGetNexts
Description	The total number of SNMP Get-Next PDUs generated.
Host Address	Not available
SNMP Object ID	1.3.6.1.2.1.11.26
Type	Counter
Attributes	Read-only
Default Value	Always reads 0
Implemented Version	2.6.3

Name	snmpOutSetRequests
Description	The total number of SNMP Set-Request PDUs generated.
Host Address	Not available
SNMP Object ID	1.3.6.1.2.1.11.27
Type	Counter
Attributes	Read-only
Default Value	Always reads 0
Implemented Version	2.6.3

Name	snmpOutGetResponses
Description	The total number of SNMP Get-Response PDUs generated.
Host Address	0x150001 (same as <i>snmpOutPackets</i>)
SNMP Object ID	1.3.6.1.2.1.11.28
Type	Counter
Attributes	Read-only
Default Value	0
Implemented Version	2.6.3

Name	snmpOutTraps
Description	The total number of SNMP Trap PDUs generated.
Host Address	Not available
SNMP Object ID	1.3.6.1.2.1.11.29
Type	Counter
Attributes	Read-only
Default Value	Always reads 0
Implemented Version	2.6.3

Name	snmpEnableAuthenTraps
Description	Indicates whether the SNMP agent process is permitted to generate authentication-failure traps. The value of this object overrides any configuration information. It provides a means to disable all authentication-failure traps.
Host Address	0x15000F
SNMP Object ID	1.3.6.1.2.1.11.30
Type	Integer
Attributes	Read-only
Default Value	Always reads 2
Implemented Version	2.6.0

Name	snmpSilentDrops
Description	The total number of GetRequest-PDUs, GetNextRequest-PDUs, GetBulkRequest-PDUs, SetRequest-PDUs, and InformRequest-PDUs received which were silently dropped because the size of a reply containing an alternate Response-PDU with an empty variable-bindings field was greater than either a local constraint or the maximum message size associated with the originator of the request.
Host Address	Not available
SNMP Object ID	1.3.6.1.2.1.11.31
Type	Counter
Attributes	Read-only
Default Value	Always reads 0
Implemented Version	2.6.3

Name	snmpProxyDrops
Description	The total number of GetRequest-PDUs, GetNextRequest-PDUs, GetBulkRequest-PDUs, SetRequest-PDUs, and InformRequest-PDUs received which were silently dropped because the transmission of the (possibly translated) message to a proxy target failed in a manner (other than a time-out) such that no Response-PDU could be returned.
Host Address	Not available
SNMP Object ID	1.3.6.1.2.1.11.32
Type	Counter
Attributes	Read-only
Default Value	Always reads 0
Implemented Version	2.6.3

7.4 CobraNet Variables

7.4.1 Firmware

Name	firmwareProtocolVersion
Description	Highest CobraNet protocol version supported by firmware. Current protocol version is 2. A protocol version of 0 indicates an unsupported test version of firmware.
Host Address	0x0
SNMP Object ID	1.3.6.1.4.1.2680.1.1.1.1
Type	Integer
Attributes	Read-only
Implemented Version	2.1.0

Name	firmwareMajorVersion
Description	CobraNet firmware major revision number.
Host Address	0x1
SNMP Object ID	1.3.6.1.4.1.2680.1.1.1.2
Type	Integer
Attributes	Read-only
Implemented Version	2.1.0

Name	firmwareMinorVersion
Description	CobraNet firmware minor revision number.
Host Address	0x2
SNMP Object ID	1.3.6.1.4.1.2680.1.1.1.3
Type	Integer
Attributes	Read-only
Implemented Version	2.1.0

Name	firmwareBootVersion
Description	Configuration record revision number. The configuration record contains the MAC address for the interface and other permanent initialization parameters.
Host Address	0x3
SNMP Object ID	1.3.6.1.4.1.2680.1.1.1.4
Type	Integer
Attributes	Read-only
Implemented Version	2.1.0

Name	firmwareMfgId
Description	Identifies the manufacturer of the CobraNet device. 0 represents unknown.
Host Address	0x4
SNMP Object ID	1.3.6.1.4.1.2680.1.1.1.5
Type	Integer
Attributes	Read-only
Implemented Version	2.1.0

Name	firmwareMfgProductId
Description	Identifies product type per manufacturer. Product identifiers are unique per manufacturer identifier. 0 represents unknown product.
Host Address	0x5
SNMP Object ID	1.3.6.1.4.1.2680.1.1.1.6
Type	Integer
Attributes	Read-only
Implemented Version	2.1.0

Name	firmwareMfgVersion
Description	A manufacturer assigned minor revision number for firmware. A non-zero value indicates manufacturer has made some modification to the standard firmware as released by Cirrus Logic.
Host Address	0x6
SNMP Object ID	1.3.6.1.4.1.2680.1.1.1.7
Type	Integer
Attributes	Read-only
Implemented Version	2.1.0

Name	firmwareRestart
Description	<p>Reboots the interface when set to a non-zero value. Invoking this function will cause loss of communications. The interface will attempt to send a response to an SNMP set request before restarting. Due to the nature of SNMP, receipt of such a response by the manager is not guaranteed. Invoking this feature via HMI will cause the HMI to become inoperable until the interface has completed re-initialization. A successful restart can be verified by reading the <i>sysUpTime</i> variable. <i>sysUpTime</i> returns to 0 following a restart.</p> <p>A restart via SNMP may adversely affect an HMI connected host processor. Care should be taken to insure that a host processor attempting to communicate via HMI during reset can recover from the HMI's failure to respond and, further, that the host processor will continue to function properly following reinitialization of the MI variables to their default or persistent values.</p>
Host Address	0x100
SNMP Object ID	1.3.6.1.4.1.2680.1.1.1.8
Type	Integer
Attributes	Read/Write
Default Value	0
Implemented Version	2.6.3. Not implemented on CS18xx-based platforms.

7.4.2 Hardware Identification

Different platforms and hardware version have different channel and processing capacities. By recognizing the capabilities of the interface, the host may optimize the configuration to take advantage of the capabilities.

Before the introduction of the variables documented below, the host could use sysDescr, sysObjectID and firmwareVersion* to determine the capabilities. With the introduction of the CM-1 rev F, these variables no longer fully characterize the interface. CM-1 rev F features a memory speed increase and thus a capacity improvement over CM-1 rev E and previous revisions.

Name	firmwareHardwarePlatform
Description	CobraNet interface hardware platform. 1 - RAVE 2 - Reference design 3 - High capacity reference design 4 - CM-1 with AMD flash memory (alternate supplier) 5 - CM-1 with Micron flash memory (standard supplier) 18100 - CS18100 18101 - CS18101 18102 - CS18102 18110 - CS18110 18111 - CS18111 18112 - CS18112
Host Address	0x7
SNMP Object ID	1.3.6.1.4.1.2680.1.1.1.9
Type	Integer
Attributes	Read-only
Implemented Version	2.9.10, 2.10.5

Name	firmwareHardwareVersion
Description	Version number specific to platform. 1 - Reported for all RAVE and reference design hardware as these platforms lack hardware version identification feature: CM-1 rev A-C (95Mhz) and CS18101 rev 1 (prototypes). 2 - CM-1 rev C-E (100 MHz-capable) and CS181xx rev 2 3 - CM-1 rev F (1 WS-capable)
Host Address	0x8
SNMP Object ID	1.3.6.1.4.1.2680.1.1.1.10
Type	Integer
Attributes	Read-only
Implemented Version	2.9.10, 2.10.5

7.4.3 Flash

Name	flashTotalSize
Description	Total flash memory size in bytes.
Host Address	0x1000
SNMP Object ID	1.3.6.1.4.1.2680.1.1.2.1
Type	Integer
Attributes	Read-only
Implemented Version	2.1.0

Name	flashSectorSize
Description	Largest flash sector size in bytes. Sector size is visible via TFTP where each sector is presented as a system file. Some flash memories have sectors that vary in size and it is not safe to use this variable to determine sector size. The safe way to determine sector size is to read each sector via TFTP. The amount of data returned will indicate the sector size.
Host Address	0x1001
SNMP Object ID	1.3.6.1.4.1.2680.1.1.2.2
Type	Integer
Attributes	Read-only
Implemented Version	2.1.0

Name	flashPersistSequence
Description	Sequence number for persistence storage. This gives an approximate indication of the wear on the flash memory from persistent stores. The sequence number is incremented each time a sector is erased to make room for a persistent store. Typically two sectors are used for persistent storage. The sequence number divided by the number of sectors used for persistence yields the approximate erase cycle count each sector has experienced. Flash memory is typically rated for no less than 100,000 erase cycles.
Host Address	0x1002
SNMP Object ID	1.3.6.1.4.1.2680.1.1.2.3
Type	Counter
Attributes	Read-only
Implemented Version	2.8.1

Name	flashPersistType
Description	Indicates the type identifier for the persistent store dataset. If firmware is updated to a version that uses a different dataset type (or different size), persistent settings will be lost.
Host Address	0x1003
SNMP Object ID	1.3.6.1.4.1.2680.1.1.2.4
Type	Integer
Attributes	Read-only
Implemented Version	2.8.1

Name	flashPersistSize
Description	Size in words of the persistent store dataset. If firmware is updated to a version that uses a different dataset size (or different type), persistent settings will be lost.
Host Address	0x1004
SNMP Object ID	1.3.6.1.4.1.2680.1.1.2.5
Type	Integer
Attributes	Read-only
Implemented Version	2.8.1

Name	flashPersistStores
Description	The number of times variables have been written to flash during <i>sysUpTime</i> . Use of <i>flashPersistAck</i> is preferred to determine completion of a persistent save operation.
Host Address	0x1005
SNMP Object ID	1.3.6.1.4.1.2680.1.1.2.6
Type	Counter
Attributes	Read-only
Default Value	0
Implemented Version	2.8.1

Name	flashTacknowledge
Description	A semaphore variable updated to the value of <i>flashTRequest</i> on completion of a flash write.
Host Address	0x1006
SNMP Object Identifier	Not available via SNMP
Type	Integer
Attributes	Read-only
Implemented Version	2.8.6

Name	flashPersistEnable
Description	Non-zero value enables variable persistence feature. Read/write - Persistent type variables will be automatically written to non-volatile memory when changed. Values will be restored on power-up.
Host Address	0x1100
SNMP Object ID	1.3.6.1.4.1.2680.1.1.2.7
Type	Integer
Attributes	Read/write - Persistent
Default Value	0
Implemented Version	2.8.1

Name	flashPersistAck
Description	Forces a write of variables to non-volatile memory when set to a non-zero value. Value returns to zero when write has completed. This value will not change if persistence is disabled. This feature is recommended for use during factory configuration where writing and confirmation of success must be done in a timely manner. In normal use it is best to let the interface schedule writes to non-volatile memory. Over-use of this feature can result in excessive wear on the flash device.
Host Address	0x1200
SNMP Object ID	1.3.6.1.4.1.2680.1.1.2.8
Type	Integer
Attributes	Read/Write
Default Value	0
Implemented Version	2.8.1

Name	flashTRequest
Description	When changed, causes data transfer to begin between flash memory and <i>bridgeTxPktBuffer</i> . Transfer begins when set to a value different than <i>flashTAcknowledge</i> .
Host Address	0x1201
SNMP Object Identifier	Not available via SNMP
Type	Integer
Attributes	Read/Write
Implemented Version	2.8.6

Name	flashTAddress
Description	Specifies the source (read) or destination (write) address in flash memory. This address is a byte offset into flash memory. For an erase operations this variable can be set to any address within the sector to be erased. Following read and write operations <i>flashTAddress</i> is incremented by <i>flashTLength</i> ($flashTAddress += flashTLength$)
Host Address	0x1202
SNMP Object Identifier	Not available via SNMP
Type	Integer
Attributes	Read/Write
Implemented Version	2.8.6

Name	flashTLength
Description	Specifies the number of bytes to be transferred between flash and transmit buffer. This value should never exceed the byte size of <i>bridgeTxPktBuffer</i> . A flash operation is not allowed to straddle a sector boundary. This variable is ignored for erase operations.
Host Address	0x1203
SNMP Object Identifier	Not available via SNMP
Type	Integer
Attributes	Read/Write
Implemented Version	2.8.6

Name	flashTDirection
Description	Specifies whether the transaction is a flash sector read, write or erase. 0 - Read flash to transmit buffer 1 - Write flash from transmit buffer 2 - Erase flash sector
Host Address	0x1204
SNMP Object Identifier	Not available via SNMP
Type	Integer
Attributes	Read/Write
Implemented Version	2.8.6

7.4.4 Errors

Name	errorPOSTResults
Description	Power on self-test results. 0 - no errors detected. Currently the CobraNet interface does not recover from a POST failure. This variable will always report 0. A POST failure is reported by the indicator LED's. A self-reset will be attempted following the error report.
Host Address	0x2000
SNMP Object ID	1.3.6.1.4.1.2680.1.1.3.1
Type	Integer
Attributes	Read-only
Default Value	0
Implemented Version	2.1.0

Name	errorIndicators
Description	This value is a sum of exclusive binary values which can be OR'd to represent multiple errors. 0x01 - Fault 0x04 - Receive error 0x08 - Transmit error 0x10000 - Audio mute (audio output may be corrupt) 0x20000 - BuddyLink output disabled (fault or lost contact with the network) 0x40000 - Unexpected system error (diagnostic information on firmware fault may be available in <i>errorDisplay</i>)
Host Address	0x2001
SNMP Object ID	1.3.6.1.4.1.2680.1.1.3.2
Type	Integer
Attributes	Read-only
Implemented Version	2.1.0

Name	errorCode
Description	Last error code reported. On 24-bit platforms, error code is a byte in MS byte position of this variable. On 32-bit platforms, error code is a byte in LS byte position of this variable. Some values are warnings and will not affect <i>errorIndicators</i> . See error table. Note: this variable has also been referred to as <i>errorLast</i> in older documentation and MIB files.
Host Address	0x2002
SNMP Object ID	1.3.6.1.4.1.2680.1.1.3.3
Type	Integer
Attributes	Read-only
Default Value	0
Implemented Version	2.1.0

Name	errorCount
Description	Number of errors reported during <i>sysUpTime</i> . Some errors are warnings and do not affect <i>errorIndicators</i> .
Host Address	0x2003
SNMP Object ID	1.3.6.1.4.1.2680.1.1.3.4
Type	Counter
Attributes	Read-only
Default Value	0
Implemented Version	2.1.0

Name	errorDisplay
Description	Error code to display on a user interface. Error codes are displayed for serious and unexpected error conditions. A value of 0 indicates there is no error code to display.
Host Address	0x2004
SNMP Object ID	1.3.6.1.4.1.2680.1.1.3.5
Type	Integer
Attributes	Read-only
Default Value	0
Implemented Version	2.1.0

Name	modeRateStatus
Description	Indicates the latency and sample rate operating mode currently in effect for the interface. <i>modeRateStatus</i> and <i>modeRateControl</i> will differ if an unsupported mode value is written to <i>modeRateControl</i>
Host Address	0x2005
SNMP Object ID	1.3.6.1.4.1.2680.1.1.3.6.2
Type	Integer
Attributes	Read-only
Implemented Version	2.9.0

Name	modeRateControl
Description	Selects latency and sample rate mode for the interface. The following modes are supported: 0x701 - 5-1/3 ms latency, 96-kHz sample rate 0x600 - 5-1/3 ms latency, 48-kHz sample rate 0x601 - 2-2/3 ms latency, 96-kHz sample rate 0x500 - 2-2/3 ms latency, 48-kHz sample rate 0x501 - 1-1/3 ms latency, 96-kHz sample rate 0x400 - 1-1/3 ms latency, 48-kHz sample rate
Host Address	0x2100
SNMP Object ID	1.3.6.1.4.1.2680.1.1.3.6.1
Type	Integer
Attributes	Read/write - Persistent
Default Value	0x600
Implemented Version	2.9.0

7.4.5 Conductor

These variables determine the values transmitted in the header of the Beat Packet when the CobraNet interface is acting as the network conductor.

Name	conductorCycleRate
Description	Number of isochronous cycles per second as a 16.16 fixed point number. This is a legacy variable. It always reports default value and should not be changed.
Host Address	0x10000
SNMP Object ID	1.3.6.1.4.1.2680.1.1.4.1
Type	Integer48
Attributes	Read/write - Persistent
Default Value	750
Implemented Version	2.2.0

Name	conductorPriority
Description	Specifies the conductor priority for a CobraNet device. The device with the highest priority will become the conductor for the network. MS byte must be 0. 0 - Never Conduct 0x1 - Lowest conductor priority 0xFF - highest conductor priority
Host Address	0x10002
SNMP Object ID	1.3.6.1.4.1.2680.1.1.4.2
Type	Integer16
Attributes	Read/write - Persistent
Default Value	0x20 for reference design, 0x30 for CM-1 and CS181xx.
Implemented Version	2.2.0

Name	conductorGaps
Description	These timing specifications are applicable only to repeater networks and therefore do not apply to most CobraNet applications. This variable is changed on the active conductor in order to reduce the probability of collisions. In most cases the default value works well. Useful values other than the default are dependant on the specific network topology used. Channel Gap in LS byte - Larger channel gaps allow greater network diameter. Packet Gap in MS byte - Larger packet gaps increase resilience to unregulated traffic.
Host Address	0x10003
SNMP Object ID	1.3.6.1.4.1.2680.1.1.4.3
Type	Integer16
Attributes	Read/write - Persistent
Default Value	0x0306
Implemented Version	2.2.0

Name	conductorStatus
Description	Conductor status: 0 - This interface is not the conductor 1 - This interface is the conductor
Host Address	0x11000
SNMP Object ID	1.3.6.1.4.1.2680.1.1.4.4
Type	Integer
Attributes	Read-only
Implemented Version	2.1.0

7.4.6 Packet Bridge

Name	bridgeTxPkt
Description	Variable is used in conjunction with <i>bridgeTxDone</i> . If <i>bridgeTxPkt</i> and <i>bridgeTxDone</i> are equal, then it is permitted to write new packet data to <i>bridgeTxPktBuffer</i> . Setting <i>bridgeTxPkt</i> different than <i>bridgeTxDone</i> will cause the contents of the packet buffer to be transmitted. Upon transmit completion, <i>bridgeTxDone</i> will be updated to match <i>bridgeTxPkt</i> . Packet transmission can also be initiated by issuing a Packet Transmit command via HMI.
Host Address	0x20000
SNMP Object ID	Not available via SNMP
Type	Integer
Attributes	Read/Write
Default Value	0
Implemented Version	2.2.0

Name	bridgeRxPkt
Description	This variable is used in conjunction with <i>bridgeRxReady</i> . If values of <i>bridgeRxPkt</i> and <i>bridgeRxReady</i> differ, then <i>bridgeRxPktBuffer</i> contains received data and may be read by the host. Setting <i>bridgeRxPkt</i> equal to <i>bridgeRxReady</i> will release the buffer to the CobraNet interface so that the next packet can be received.
Host Address	0x20001
SNMP Object ID	Not available via SNMP
Type	Integer
Attributes	Read/Write
Default Value	0
Implemented Version	2.2.0

Name	bridgeMMAC
Description	Specifies the source multicast MAC address of packets to be received via the packet bridge. To receive multicast addressed packets, it is necessary to compute and load a multicast hash filter table into <i>bridgeHashBuffer</i> .
Host Address	0x20002 - 0x20004
SNMP Object ID	Not available via SNMP
Type	PhysAddress
Attributes	Read/Write
Default Value	00:00:00:00:00:00
Implemented Version	2.2.0

Name	bridgeCalcMMACHash
Description	This variable is used to calculate a hash value based on the address in <i>bridgeMMAC</i> . Writing a value different than <i>bridgeMMACHashDone</i> to this variable causes the calculation to begin. When complete, <i>bridgeMMACHashDone</i> will be updated with the value written here and <i>bridgeMACHashBuf</i> will contain the new hash value. Folding <i>bridgeMACHashBuf</i> results into <i>bridgeHashBuf</i> will then allow receipt of packets from the multicast address specified in <i>bridgeMMAC</i> .
Host Address	0x20005
SNMP Object ID	Not available via SNMP
Type	Integer
Attributes	Read/Write
Default Value	0
Implemented Version	2.2.0

Name	bridgeMMACHashBuffer
Description	This is the calculated hash value for the MAC address entered in <i>bridgeMMAC</i> .
Host Address	0x20006 - 0x20009
SNMP Object ID	Not available via SNMP
Size	4 words
Type	Octet String
Attributes	Read/Write
Default Value	0
Implemented Version	2.2.0

Name	bridgeHashBuffer
Description	This is the value loaded to the hash table of the Ethernet controller which determines the range of multicast addresses the host will receive.
Host Address	0x2000A - 0x2000D
SNMP Object ID	Not available via SNMP
Size	4 words
Type	Octet String
Attributes	Read/Write
Default Value	0
Implemented Version	2.2.0

Name	bridgeRxFilter
Description	<p>Selects which types of received packets will be passed to the host via the packet bridge. The following values may be ORed together. See Figure 4 on page 14.</p> <p>0x1 - bridge unprocessed CobraNet packets 0x2¹ - bridge all CobraNet reservation packets 0x8¹ - bridge all IP packets (IP, ARP and RARP) 0x10 - bridge all packets with unknown protocol identifier</p> <p>¹Copies of packets are passed to the packet bridge and the originals are still processed by the CobraNet interface. Care must be taken that redundant replies are not generated.</p>
Host Address	0x2000E
SNMP Object ID	Not available via SNMP
Type	Integer
Attributes	Read/Write
Default Value	1
Implemented Version	2.6.9

Name	bridgeTxPktBuffer
Description	<p>Buffer for bridge packet transmission. The first word contains the length of the packet in bytes exclusive of the length field itself. Ethernet packet data, including complete header and payload, follows the length. The FCS field is computed and appended by the Ethernet controller and is not included as part of the packet data or length.</p> <p>See Section 2.2 "Packet Bridge" on page 12 for more information on the format and use of this buffer</p>
Host Address	0x21000
SNMP Object ID	Not available via SNMP
Count	758 on 24-bit platforms, 380 on 32-bit platforms.
Type	Integer16
Attributes	Read/Write
Implemented Version	2.2.0

Name	bridgeRxPktBuffer
Description	Buffer to read received packet. The data format for packet data is the same as used in <i>bridgeTxPktBuffer</i> .
Host Address	0x22000
SNMP Object ID	Not available via SNMP
Count	1 + actual packet size in words.
Type	Integer16
Attributes	Read/Write
Implemented Version	2.2.0

Name	bridgeTxDone
Description	Please refer to <i>bridgeTxPkt</i> documentation. This variable is used in conjunction with <i>bridgeTxPkt</i> .
Host Address	0x23000
SNMP Object ID	Not available via SNMP
Type	Integer
Attributes	Read-only
Default Value	0
Implemented Version	2.2.0

Name	bridgeRxReady
Description	Please refer to <i>bridgeRxPkt</i> documentation. This variable is used in conjunction with <i>bridgeRxPkt</i> .
Host Address	0x23001
SNMP Object ID	Not available via SNMP
Type	Integer
Attributes	Read-only
Default Value	0
Implemented Version	2.2.0

Name	bridgeMMACHashDone
Description	Refer to <i>bridgeCalcMMACHash</i> documentation. This variable is used in conjunction with <i>bridgeCalcMMACHash</i> .
Host Address	0x23002
SNMP Object ID	Not available via SNMP
Type	Integer
Attributes	Read-only
Default Value	0
Implemented Version	2.2.0

Name	bridgeRxDropped
Description	Counts the number of received packet bridge packets dropped due to the receive buffer being unavailable. Packets which could be received via the packet bridge will be dropped if the host has ownership of the receive buffer (<i>bridgeRxPktBuffer</i>).
Host Address	0x23003
SNMP Object ID	Not available via SNMP
Type	Counter
Attributes	Read-only
Default Value	0
Implemented Version	2.5.7

7.4.7 Serial Bridge

Name	serialFormat
Description	<p>This variable is used to enable or disable the Serial Communications Interface (a.k.a SCI or Serial Bridge) and to set the data format for both transmit and receive directions. Format may only be changed while the SCI is disabled (LS bit = 0). It is recommended to set <i>serialFormat</i> to 0, wait at least 100ms then set <i>serialFormat</i> to the desired value with the enable bit set. The SCI can take up to 100ms to recognize a change. This procedure insures that the change is recognized and the port is properly configured. The following values may be OR'd together:</p> <p>0x01 - Enable serial bridging. TXD pin is tri-stated when disabled.</p> <p>0x02 - Use nine-bit data format. The 9th data bit is bridged over the Ethernet along with the standard 8 data bits. 9 bit format is appropriate for the following standard serial data formats: N,9,1 E,8,1 O,8,1 M,8,1 S,8,1 N,7,2. The 8 bit data format supports the following standard serial data formats: N,8,1 E,7,1 O,7,1 M,7,1 S,7,1. If the 8th or 9th bit is used as a parity bit, it is simply bridged across the network and must be generated and/or checked by the device connected to the bridge interface. <u>CS181xx-based hardware does not support 9-bit format; this bit is ignored.</u></p> <p>0x04 - Use SCI_SCLK to control transmit enable for multi-drop (RS485) operation. SCI_SCLK is an active high signal; transmitter should be enabled when SCI_SCLK is high. <u>CS181xx firmware does not currently support tri-state control format; this bit is ignored.</u></p> <p>0x08 - Enable local loopback. This feature is intended primarily for factory test. SCI bridging must also be enabled for loopback to operate. When loopback is enabled, received characters are directed to the SCI transmitter instead of to the network. <i>serialRxMAC</i> should be set to 00:00:00:00:00:00 to avoid transmitter contention when loopback is enabled.</p> <p>0x10 - Accept properly unicast addressed data in addition to data addressed in accordance to serialRxMAC setting.</p>
Host Address	0x24000
SNMP Object ID	1.3.6.1.4.1.2680.1.1.10.1.1
Type	Integer
Attributes	Read/write - Persistent
Default Value	0
Implemented Version	2.4.7. Available via SNMP in 2.6.4. Accept unicast (0x10 bit) implemented in 2.8.8.

Name	serialBaud
Description	Baud rate for transmission and reception. The baud rate is specified in bits per second. The minimum baud rate is 600 baud. Maximum baud rate is 57,600. CS181xx-based interfaces will support baud rates up to 115,200
Host Address	0x24001
SNMP Object ID	1.3.6.1.4.1.2680.1.1.10.1.2
Type	Integer
Attributes	Read/write - Persistent
Default Value	19200
Implemented Version	2.4.7 (available via SNMP in 2.6.4)

Name	serialPPeriod
Description	<p>Time in 256ths of a millisecond before a character received at the SCI port is placed in a packet and transmitted. Shorter periods to achieve lower latency are appropriate for real time connections such as MIDI. With higher settings more characters can be packed into a packet before it is transmitted resulting in increased efficiency. Higher settings are recommended for bulk data transfer applications.</p> <p>The isochronous cycle period (1-1/3 mS) determines the minimum <i>serialPPeriod</i>. Setting <i>serialPPeriod</i> below the isochronous cycle rate does not further improve responsiveness. The upper limit of responsiveness can also be affected by control channel accessibility and pipeline delays. The depth of the receive SCI character queue in combination with the baud rate determines the maximum allowed setting. The character buffer can accommodate 100 characters. This allows for operation at the default 10ms period at a baud rate of 57,600. At this baud rate, larger settings will result in buffer overflow and loss of data.</p>
Host Address	0x24002
SNMP Object ID	1.3.6.1.4.1.2680.1.1.10.1.3
Type	Integer
Attributes	Read/write - Persistent
Default Value	2560 (10ms)
Implemented Version	2.4.7 (available via SNMP in 2.6.4)

Name	serialRxMAC
Description	<p>MAC address of the CobraNet Interface from which SCI data will be accepted. This may be any multicast address though 01:60:2B:FD:00:00 through 01:60:2B:FD:FF:FF have been reserved by Cirrus Logic for use as "asynchronous global channels." <i>ifPhysAddress</i> is the only usable unicast address (CobraNet does not support Ethernet promiscuous mode).</p>
Host Address	0x24003
SNMP Object ID	1.3.6.1.4.1.2680.1.1.10.1.4
Type	PhysAddress
Attributes	Read/write - Persistent
Default Value	01:60:2B:FD:00:00
Implemented Version	2.4.7 (available via SNMP in 2.6.4)

Name	serialTxPriority
Description	<p>Serial bridging bundle priority in MS byte. Higher priority bundles are transmitted earlier in the isochronous cycle and are thus less susceptible to dropouts in the event network bandwidth is exhausted. Request priority in LS byte. Contention for transmission on a bundle is resolved via request priority.</p> <p>This variable has no effect when <i>serialTxBundle</i> is 0.</p> <p><i>The reference design, CM-1, CM-2 and CS181xx-based designs do not support isochronous transmission of serial data and ignore settings for serialTXBundle and serialTxPriority.</i></p>
Host Address	0x24006
SNMP Object ID	1.3.6.1.4.1.2680.1.1.10.1.5
Type	Integer16
Attributes	Read/write - Persistent
Default Value	0x0110
Implemented Version	2.4.7 (available via SNMP in 2.6.4)

Name	serialTxBundle
Description	<p>On legacy repeater Ethernet networks and CobraNet interface hardware, serialTXBundle is used to specify a bundle number for use in transmitting serial data reliably over CobraNet's isochronous audio transport service. Specifying bundle 0 causes serial data to be delivered normally via the asynchronous transport. This is the default and recommended setting.</p> <p><i>The reference design, CM-1, CM-2 and CS181xx-based designs do not support isochronous transmission of serial data and ignore settings for serialTXBundle and serialTxPriority.</i></p>
Host Address	0x24007
SNMP Object ID	1.3.6.1.4.1.2680.1.1.10.1.6
Type	Integer16
Attributes	Read/write - Persistent
Default Value	0
Implemented Version	2.4.7 (available via SNMP in 2.6.4)

Name	serialTxMAC
Description	MAC address of the CobraNet interface to which serial data is sent. May be any multicast or unicast address.
Host Address	0x24100
SNMP Object ID	1.3.6.1.4.1.2680.1.1.10.1.7
Type	PhysAddress
Attributes	Read/write - Persistent
Default Value	01:60:2B:FD:00:00
Implemented Version	2.4.7 (available via SNMP in 2.6.4)

7.4.8 Interrupt Control

Name	hackEnable
Description	Enable conditions for asserting HACK. HACK is de-asserted by issuing an Interrupt Acknowledge HMI command. The following values may be OR'ed together 0x4 - Activate HACK on bridge packet receipt (change in <i>bridgeRxReady</i>). 0x8 - Activate HACK on bridge packet transmission complete (change in <i>bridgeTxDone</i>). 0x10 - Activate HACK on HMI address translation completion (change in <i>hackTranslations</i>). 0x20 - Activate HACK on MI variable change via SNMP (change in <i>miMonSNMPDirty</i> or <i>hackSNMPModify</i>). 0x40 - Enable HACK Timer.
Host Address	0x25000
SNMP Object ID	Not available via SNMP
Type	Integer
Attributes	Read/Write
Default Value	0
Implemented Version	2.10.4

Name	hackTimerInterval
Description	A mask defining which bits of the network time should be locked to generate a HACK timer interrupt. The hackTimerInterval variable will be limited to powers of 2, in units of isochronous cycle intervals. The isochronous cycle interval is 1-1/3 ms. The correct mask value will be a power of 2 minus one. For example, a value of 0xffff will generate an interrupt every $256 * 1 - 1/3 = 341.33$ ms.
Host Address	0x25001
SNMP Object ID	Not available via SNMP
Type	Integer
Attributes	Read/Write
Default Value	0xffffffff
Implemented Version	2.10.4

Name	hackStatus
Description	Indicates the source of a HACK assertion requiring acknowledge. The following values may be OR'd together. Undocumented bits should be ignored: 0x01 - A new receive packet is available in the receive buffer. Host should read packet data from receive buffer and then acknowledge receipt. 0x02 - No transmission in progress. Host may write transmit packet data into the transmit buffer. On 32-bit platforms, these bits may also be read in the HMI status register <i>Received packet available</i> and <i>Packet transmission complete</i> .
Host Address	0x25100
SNMP Object ID	Not available via SNMP
Type	Integer
Attributes	Read-only
Implemented Version	2.8.5

Name	hackTranslations
Description	Incremented when a translate address command completes. On 32-bit platforms, this information is also available through the <i>Translation Complete</i> bit in the HMI status register.
Host Address	0x25101
SNMP Object ID	Not available via SNMP
Type	Counter
Attributes	Read-only
Implemented Version	2.8.5

Name	hackSNMPModify
Description	Copy of <i>miMonSNMPDirty</i> .
Host Address	0x25102
SNMP Object ID	Not available via SNMP
Type	Counter
Attributes	Read-only
Implemented Version	2.8.5

Name	hackReadLength
Description	Size of readable area in words for the last address traslation. 0 if read permission is denied (invalid address). This variable is updated upon completion of a translate address operation. On 32-bit platforms, this information is also available through the <i>Region length</i> field in the status register.
Host Address	0x25103
SNMP Object ID	Not available via SNMP
Type	Integer
Attributes	Read-only
Implemented Version	2.8.5

Name	hackWriteLength
Description	Size of writable area in words for the last address traslation. 0 if write permission is denied (invalid address or read only region). This variable is updated upon completion of a translate address operation. On 32-bit platforms, this information is also available through the <i>Region length</i> field in the status register.
Host Address	0x25104
SNMP Object ID	Not available via SNMP
Type	Integer
Attributes	Read-only
Implemented Version	2.8.5

Name	hackNTime
Description	CobraNet network time - a copy of <i>syncNTime</i> . CS181xx only.
Host Address	0x25105
SNMP Object ID	Not available via SNMP
Type	Integer
Attributes	Read-only
Implemented Version	2.9.9, 2.10.4

7.4.9 Audio

Name	audioMeterDropouts
Description	This counter is incremented each isochronous cycle that metering is not performed. Metering may be skipped when processor cycles are in high demand on the interface.
Host Address	0x30000
SNMP Object ID	1.3.6.1.4.1.2680.1.1.5.1
Type	Counter
Attributes	Read-only
Default Value	0
Implemented Version	2.2.0

Name	audioAllowedChannels
Description	Number of audio channels this CobraNet interface is licensed to handle. <i>AudioAllowedChannels</i> < <i>audioRxChannels</i> + <i>audioTxChannels</i> indicates a licensing violation. <u><i>There are NO license fees on CS181xx-based interfaces. Channel accounting is not implemented. On CS181xx, audioAllowedChannels, audioRxChannels and audioTxChannels always read 0.</i></u>
Host Address	0x30001
SNMP Object ID	1.3.6.1.4.1.2680.1.1.5.6
Type	Integer
Attributes	Read-only
Default Value	Read from flash configuration record.
Implemented Version	2.8.3.

Name	audioRxChannels
Description	Number of unique audio channels currently being received from the network. <u><i>On CS181xx-based interfaces this variable always reads 0.</i></u>
Host Address	0x30002
SNMP Object ID	1.3.6.1.4.1.2680.1.1.5.7
Type	Integer
Attributes	Read-only
Default Value	0
Implemented Version	2.8.3.

Name	audioTxChannels
Description	Number of unique audio channels currently being transmitted to the network. <i>On CS181xx this variable always reads 0.</i>
Host Address	0x30003
SNMP Object ID	1.3.6.1.4.1.2680.1.1.5.8
Type	Integer
Attributes	Read-only
Default Value	0
Implemented Version	2.8.3.

Name	audioMeterDecay
Description	Decay time constant for <i>audioMeters</i> . Meters have an instantaneous attack time that cannot be adjusted. This constant can be computed from the desired decay time (t) as: 24-bit platforms: $0x800000 \times ((1 - \tan(1/(1500 \times t))) / (1 + \tan(1/(1500 \times t))))$ 32-bit platforms: $0x80000000 \times ((1 - \tan(1/(1500 \times t))) / (1 + \tan(1/(1500 \times t))))$ For reasonably large decay times (>50ms) this can be approximated as: 24-bit platforms: $0x800000 \times (((1500 \times t) - 1) / ((1500 \times t) + 1))$ 32-bit platforms: $0x80000000 \times (((1500 \times t) - 1) / ((1500 \times t) + 1))$ Example decay settings: 0 - Instantaneous 8170671 (0x7CACAF) 24-bit, 2091691776 (0x7CACAF00) 32-bit - 50ms 8333053 (0x7F26FD) 24-bit, 2133261568 (0x7F26FD00) 32-bit - 200ms 8377430 (0x7FD456) 24-bit, 2144622080 (0x7FD45600) 32-bit - 1 second 8388235 (0x7FFE86) 24-bit, 2147388160 (0x7FFE8600) 32-bit - 30 seconds
Host Address	0x30100
SNMP Object ID	1.3.6.1.4.1.2680.1.1.5.5
Type	Integer
Attributes	Read/write - Persistent
Default Value	0
Implemented Version	2.6.9

Name	audioMeterMap
Description	Maps audio routing channels to audio metering. Meters 0-31 are designated for metering audio inputs. Meters 32-63 are designated for metering outputs. The first unassigned (null or unconnected routing channel) in each section terminates meter processing. It is not possible to activate meter 3 without first activating meter 2, for instance.
Host Address	0x31000
SNMP Object ID	1.3.6.1.4.1.2680.1.1.5.2.1.2
Count	64
Type	Integer
Attributes	Read/write - Persistent
Default Value	0
Implemented Version	2.2.0

Name	audioMeterPeaks
Description	The peak level is the highest level recorded since the last time the meters were reset. Level is represented as a 24- of 32-bit positive value. 0 indicating the absence of signal and 0x7FFFFF or 0x7FFFFFFF indicating a full-scale signal. Reset is accomplished by writing 0 to the peak level. It is not possible to determined if a peak level is missed between the time the variable is read and when it is cleared. Also it should be recognised that it is possible for another manager to clear this variable. There is no way of determining when this has happened.
Host Address	0x32000
SNMP Object ID	1.3.6.1.4.1.2680.1.1.5.2.1.3
Count	64
Type	Integer
Attributes	Read/write
Default Value	0
Implemented Version	2.1.0

Name	audioMeters
Description	Allows reading current audio levels. Ballistics for metering comprise an instantaneous attack and exponential decay time programmable via <i>audioMeterDecay</i> . All level measurements are peak level (as opposed to RMS). Level is reported as a 24- or 32-bit positive value. 0 indicates the complete absence of signal and 0x7FFFFFFF or 0x7FFFFFFFFF indicates a full-scale signal.
Host Address	0x33000
SNMP Object ID	1.3.6.1.4.1.2680.1.1.5.2.1.4
Count	64
Type	Integer
Attributes	Read-only
Implemented Version	2.1.0

Name	audioMeterPeakRaw
Description	Efficiently retrieve allaudioMeterPeaks values in a single Get operation. On 24-bit platforms, audioMeterPeakRaw and audioMeterRaw values are packed in 3 octet words. On CS181xx-based platforms the values are packed in 4 octet words. Byte ordering for 24-bit platforms is MS, Middle, LS. Byte ordering for 32-bit platforms is MS, Middle High, Middle Low, LS.
Host Address	0x32000
SNMP Object ID	1.3.6.1.4.1.2680.1.1.5.2.1.5
Count	64
Type	Integer
Attributes	Read/write
Default Value	0
Implemented Version	2.10.4

Name	audioMeterRaw
Description	Efficiently retrieve allaudioMeters values in a single Get operation. On 24-bit platforms, audioMeterPeakRaw and audioMeterRaw values are packed in 3 octet words. On CS181xx-based platforms the values are packed in 4 octet words. Byte ordering for 24-bit platforms is MS, Middle, LS. Byte ordering for 32-bit platforms is MS, Middle High, Middle Low, LS.
Host Address	0x32000
SNMP Object ID	1.3.6.1.4.1.2680.1.1.5.2.1.6
Count	64
Type	Integer
Attributes	Read/write
Default Value	0
Implemented Version	2.10.4

Name	audioLoopSrc
Description	Describes source audio routing channels for performing a local audio loopback function. The first unassigned (null or unconnected routing channel) loopback entry terminates loopback processing. It is not possible to activate loopback element 3 without first activating loopback 2, for instance.
Host Address	0x34000
SNMP Object ID	1.3.6.1.4.1.2680.1.1.5.3.1.2
Count	8 in standard firmware build.
Type	Integer
Attributes	Read/write - Persistent
Default Value	0
Implemented Version	2.1.0

Name	audioLoopDst
Description	Describes destination audio routing channels for performing a local audio loopback function. See <i>audioLoopSrc</i> for a complete description.
Host Address	0x35000
SNMP Object ID	1.3.6.1.4.1.2680.1.1.5.3.1.3
Count	8 in standard firmware build
Type	Integer
Attributes	Read/write - Persistent
Default Value	0
Implemented Version	2.1.0

Name	audioOutputs
Description	List of audio output routing channels. Audio output data must be cleared to silence if data is not received over the network for the channels. By default 33 - 64 are used as outputs but these variables may be configured by the manufacturer according to the audio I/O configuration of the hardware. The user should not change these values.
Host Address	0x36000
SNMP Object ID	1.3.6.1.4.1.2680.1.1.5.4.1.2
Count	32
Type	Integer
Attributes	Read/write - Persistent
Default Value	{33, 34, 35, 36, 37, 38, 39, 40, 41, 42, 43, 44, 45, 46, 47, 48, 49, 50, 51, 52, 53, 54, 55, 56, 57, 58, 59, 60, 61, 62, 63, 64}
Implemented Version	2.1.0

Name	audioMap
Description	Audio routing channel to synchronous serial audio channel mapping. Each entry specifies an SSI audio buffer offset corresponding to a routing channel. The first <i>audioMap</i> entry corresponds to routing channel 1. These variables are configured by the manufacturer according to the audio I/O configuration of the hardware. Cirrus Logic can assist manufacturers in determining proper configuration of these variables to match audio I/O hardware. The user should not change these values.
Host Address	0x37000
SNMP Object ID	1.3.6.1.4.1.2680.1.1.5.2.1.5
Count	64
Type	Integer
Attributes	Read/write - Persistent
Default Value	Product specific
Implemented Version	2.1.0

Name	audioDupSrc
Description	A vector used to specify the source audio routing channels used in audio channel duplication. Each audioDupSrc vector member will have a corresponding audioDupDst member corresponding to each available duplication channel. AudioDupSrc will contain the source audio routing channel number and audioDupDst will contain the corresponding destination audio routing channel. The audio routing channel chosen as either a source or destination must be an output channel (i.e. appear in audioOutputs which, by default, consists of audio routing channels 33-64). The first unassigned entry (null or unconnected routing channel for either source or destination) terminates dup processing. For instance, it is not possible to specify dup channel 3 without first specifying dup channel 2.
Host Address	0x38000
SNMP Object ID	1.3.6.1.4.1.2680.1.1.5.9.1.2
Count	0 in standard CM-1 firmware, 8 in CS181xx firmware.
Type	Integer
Attributes	Read/Write
Implemented Version	2.8.5

Name	audioDupDst
Description	A vector used to specify the source audio routing channels used in audio channel duplication. See audioDupSrc.
Host Address	0x39000
SNMP Object ID	1.3.6.1.4.1.2680.1.1.5.9.1.3
Count	0 in standard CM-1 firmware, 8 in CS181xx firmware.
Type	Integer
Attributes	Read/Write
Implemented Version	2.8.5

Name	audioMeterPeaksRaw
Description	Efficiently retrieve all <i>audioMeterPeaks</i> values in a single Get operation. 24-bit platforms: values are packed in 3 octet words. Byte ordering is Most Significant, Middle, Least Significant. 32-bit platforms: values are packed in 4 octet words. Byte ordering is Most Significant, Middle High, Middle Low, Least Significant.
Host Address	Not available via HMI
SNMP Object ID	1.3.6.1.4.1.2680.1.1.5.10
Type	Octet string
Attributes	Read-only
Implemented Version	2.9.3, 2.10.5

Name	audioMetersRaw
Description	Efficiently retrieve all <i>audioMeters</i> values in a single Get operation. 24-bit platforms: values are packed in 3 octet words. Byte ordering is Most Significant, Middle, Least Significant. 32-bit platforms: values are packed in 4 octet words. Byte ordering is Most Significant, Middle High, Middle Low, Least Significant.
Host Address	Not available via HMI
SNMP Object ID	1.3.6.1.4.1.2680.1.1.5.11
Type	Octet string
Attributes	Read-only
Implemented Version	2.9.3, 2.10.5

Name	audioSSIFormat
Description	Format of SSI channel data. 0 - Normal Mode 1 - I2S Mode 2 - Standard Mode Default is Normal Mode See Hardware User's Manual for SSI mode descriptions.
Host Address	0x30004
SNMP Object ID	1.3.6.1.4.1.2680.1.1.5.12
Type	Integer
Attributes	Read-only
Implemented Version	2.9.10, 2.10.5

7.4.10 Receivers

Name	rxStatus
Description	Indicates bundle reception. Bundle reception does not necessarily indicate audio reception. Consult <i>rxSubFormat</i> variables for audio reception status. 0 - Bundle is not being received 1 - Bundle is being received
Host Address	0x4n000 (n is 0 based receiver number)
SNMP Object ID	1.3.6.1.4.1.2680.1.1.6.1.1.6.n (n is 1 based receiver number)
Type	Integer
Attributes	Read-only
Implemented Version	2.1.0

Name	rxDropouts
Description	Counts number of times bundle reception has been interrupted. Interruptions can be caused by transmitter failure or by reconfiguring the receiver. This variable is implemented by counting transitions to 0 of <i>rxStatus</i> .
Host Address	0x4n001 (n is 0 based receiver number)
SNMP Object ID	1.3.6.1.4.1.2680.1.1.6.1.1.7.n (n is 1 based receiver number)
Type	Counter
Attributes	Read-only
Default Value	0
Implemented Version	2.1.0

Name	rxDelay
Description	Indicates additional group delay imposed on the received audio due to network forwarding delays. Delay is expressed in units of audio transmission cycles (1-1/3ms for standard 5-1/3ms latency mode, 2/3ms for 2-2/3ms latency mode and 1/3ms for 1-1/3ms latency mode). Forwarding delay is continuously monitored by the receiver. If forwarding delay changes due to a network reconfiguration or change in <i>rxBundle</i> , the receiver delay will adapt to the new conditions. A discontinuity in the audio stream will be experienced whenever the receiver delay is adjusted in this manner. Normal propagation delay is 4 isochronous cycle periods. This normal condition is indicated by a 0 reading in <i>rxDelay</i> . A reading of 1 indicates an additional isochronous cycle period delay (for a total of 5 cycles) has been inserted due to network forwarding delay.
Host Address	0x4n002 (n is 0 based receiver number)
SNMP Object ID	1.3.6.1.4.1.2680.1.1.6.1.1.8.n (n is 1 based receiver number)
Type	Integer16
Attributes	Read-only
Implemented Version	2.6.3

Name	rxMinDelay
Description	Selects a minimum additional delay imposed on the received audio. Delay is expressed in units of isochronous cycles (1-1/3ms for standard 5-1/3ms latency mode, 2/3ms for 2-2/3ms latency mode and 1/3ms for 1-1/3ms latency mode). This variable is designed to allow configuration of a deterministic common delay for all CobraNet interfaces in larger network installations. <i>rxDelay</i> will never be reduced below this setting. This variable is <u>not</u> designed for actively delaying audio for architectural applications. The maximum setting for <i>rxMinDelay</i> is determined by the amount of Ethernet packet buffering available on the interface. Excessive settings will result in ERROR_RXBUFFER_OVERFLOW errors and accompanying audio dropouts.
Host Address	0x4n106 (n is 0 based receiver number)
SNMP Object ID	1.3.6.1.4.1.2680.1.1.6.1.1.9.n (n is 1 based receiver number)
Type	Integer16
Attributes	Read/write - Persistent
Default Value	0
Implemented Version	2.8.3

Name	rxSubFormat
Description	Vector of received audio format for each sub-channel. See Table 6 on page 26 for a complete listing of valid format values. The least significant bit of these variables is set when the received format is supported for reception by the CobraNet interface. A test of this least significant bit can be used to determine correct reception on a per audio channel basis. All entries in this vector will be 0 if <i>rxStatus</i> is zero.
Host Address	0x4n30m (n is 0 based receiver number, m is 0 based audio channel number)
Count	8
SNMP Object ID	1.3.6.1.4.1.2680.1.1.6.2.1.3.n.m (n is 1 based receiver number, m is the 1 based sub-channel number)
Type	Integer
Attributes	Read-only
Implemented Version	2.2.0

Name	rxBundle
Description	Receive bundle assignment.
Host Address	0x4n100 (n is 0 based receiver number)
SNMP Object ID	1.3.6.1.4.1.2680.1.1.6.1.1.2.n (n is 1 based receiver number)
Type	Integer16
Attributes	Read/write - Persistent
Default Value	0
Implemented Version	2.1.0

Name	rxSourceMAC
Description	Source MAC address for private channel reception. Must be set to 00:00:00:00:00:00 for public and broadcast channel reception.
Host Address	0x4n101 - 0x4n103 (n is 0 based receiver number)
SNMP Object ID	1.3.6.1.4.1.2680.1.1.6.1.1.3.n (n is 1 based receiver number)
Type	PhysAddress
Attributes	Read/write - Persistent
Default Value	00:00:00:00:00:00
Implemented Version	2.1.0

Name	rxPriority
Description	Suggested channel priority in MS byte. Transmitter may use this suggestion when submitting forward reservations. Request priority in LS byte. If a transmitter is able to service a limited number of receivers due to <i>txUnicastMode</i> selection, the request priority determines which receivers are serviced.
Host Address	0x4n104 (n is 0 based receiver number)
SNMP Object ID	1.3.6.1.4.1.2680.1.1.6.1.1.4.n (n is 1 based receiver number)
Type	Integer16
Attributes	Read/write - Persistent
Default Value	0x1010
Implemented Version	2.4.8

Name	rxBuddyExclude
Description	Controls BuddyLink operation for this receiver: 0 - Reverse reservations for this receiver are suspended when BuddyLink signal is detected. i.e. the interface will not be able to receive audio bundles when BuddyLink signal is detected. 1 - Reverse reservations are never suspended. Also see <i>syncBuddyLinkControl</i> .
Host Address	0x4n105 (n is 0 based receiver number)
SNMP Object ID	1.3.6.1.4.1.2680.1.1.6.1.1.5.n (n is 1 based receiver number)
Type	Integer
Attributes	Read/write - Persistent
Default Value	0
Implemented Version	2.5.0

Name	rxSubMap
Description	Audio routing channel destinations for each audio channel in a received bundle.
Host Address	0x4n20m (n is 0 based receiver number, m is 0 based audio channel number)
Count	8
SNMP Object ID	1.3.6.1.4.1.2680.1.1.6.2.1.2.n.m (n is 1 based receiver number, m is the 1 based audio channel number)
Type	Integer
Attributes	Read/write - Persistent
Default Value	First receiver {33, 34, 35, 36, 37, 38, 39, 40} Second receiver {41, 42, 43, 44, 45, 46, 47, 48} Third receiver {49, 50, 51, 52, 53, 54, 55, 56} Fourth receiver {57, 58, 59, 60, 61, 62, 63, 64}
Implemented Version	2.1.0

7.4.11 Transmitters

Name	txDropouts
Description	Count of times channel transmission has been interrupted. Interruptions can be caused by loss of transmit permission from conductor or by changes to <i>txBundle</i> . Implemented by counting transitions to 0 of <i>txPosition</i> .
Host Address	0x5n000 (n is 0 based transmitter number)
SNMP Object ID	1.3.6.1.4.1.2680.1.1.7.1.1.7.n (n is 1 based transmitter number)
Type	Counter
Attributes	Read-only
Default Value	0
Implemented Version	2.1.0

Name	txPosition
Description	Transmission permission position. 0 indicates no transmission either because the conductor has not granted permission (due to bandwidth constraints or bundle conflict) or <i>txBundle</i> is set to 0. Valid values are 0 through the number of bundles active on the network. A value of 1 indicates the transmitter has the highest priority on the network and will be the last to be dropped if bandwidth is exhausted.
Host Address	0x5n001 (n is 0 based transmitter number)
SNMP Object ID	1.3.6.1.4.1.2680.1.1.7.1.1.8.n (n is 1 based transmitter number)
Type	Integer
Attributes	Read-only
Default Value	0
Implemented Version	2.1.0

Name	txReceivers
Description	Number of receivers requesting this bundle. This may not be valid for multicast bundles as receivers of multicast bundles are not required to issue a reverse reservation although all receivers currently do. A transmitter will track no more than 4 receivers. <i>txReceivers</i> will never exceed 4.
Host Address	0x5n002 (n is 0 based transmitter number)
SNMP Object ID	1.3.6.1.4.1.2680.1.1.7.1.1.9.n (n is 1 based transmitter number)
Type	Integer
Attributes	Read-only
Implemented Version	2.5.7

Name	txBundle
Description	Transmit bundle assignment.
Host Address	0x5n100 (n is 0 based transmitter number)
SNMP Object ID	1.3.6.1.4.1.2680.1.1.7.1.1.2.n (n is 1 based transmitter number)
Type	Integer16
Attributes	Read/write - Persistent
Default Value	0
Implemented Version	2.1.0

Name	txDestinationMAC
Description	This variable is unused and should not be changed from its default value.
Host Address	0x5n101 (n is 0 based transmitter number)
SNMP Object ID	1.3.6.1.4.1.2680.1.1.7.1.1.3.n (n is 1 based transmitter number)
Type	PhysAddress
Attributes	Read/write - Persistent
Default Value	00:00:00:00:00:00
Implemented Version	2.2.0

Name	txPriority
Description	<p>This is a two part variable used to set the preferred time within an isochronous cycle that a bundle is sent and also the priority this bundle should be given in the event that more than one interface is attempting to transmit using the same bundle number.</p> <p>MS byte: Bundle priority. Higher priority bundles are transmitted earlier in the cycle. This can be reflected in <i>txPosition</i>. On a repeater network, and to some extent on a switched network, bundles transmitted earlier may be less susceptible to dropouts in the event network bandwidth is exhausted.</p> <p>LS byte: Request priority. Only one transmitter is permitted per bundle. If two transmitters attempt to transmit using the same bundle number, request priority is used to resolve the contention. If request priority is the same for both transmitters, contention resolution is first-come-first-serve.</p>
Host Address	0x5n104 (n is 0 based transmitter number)
SNMP Object ID	1.3.6.1.4.1.2680.1.1.7.1.1.4.n (n is 1 based transmitter number)
Type	Integer16
Attributes	Read/write - Persistent
Default Value	0x1010
Implemented Version	2.2.0

Name	txSubCount
Description	Number of audio channels to transmit in a bundle. Valid values are 0 through 8. Reducing <i>txSubCount</i> is the preferred means for transmitting bundles with less than the maximum 8 audio channels. Short bundles may also be transmitted by setting <i>txSubFormat</i> or <i>txSubMap</i> entries to 0.
Host Address	0x5n105 (n is 0 based transmitter number)
SNMP Object ID	1.3.6.1.4.1.2680.1.1.7.1.1.5.n (n is 1 based transmitter number)
Type	Integer
Attributes	Read/write - Persistent
Default Value	8
Implemented Version	2.1.0

Name	txBuddyExclude
Description	Control BuddyLink operation on this channel: 0 - Transmission suspended when BuddyLink signal is detected. 1 - Transmission is never suspended. Also see <i>syncBuddyLinkControl</i>
Host Address	0x5n106 (n is 0 based transmitter number)
SNMP Object ID	1.3.6.1.4.1.2680.1.1.7.1.1.6.n (n is 1 based transmitter number)
Type	Integer
Attributes	Read/write - Persistent
Default Value	0
Implemented Version	2.5.0

Name	txUnicastMode
Description	<p>Specifies the number of unicast destinations served before automatically switching to multicast bundle transmission. Multicast transmission is useful for efficient point to multipoint routing. However, multicast addressing consumes bandwidth on all ports on a switched network. This variable allows control of multicast traffic from transmitters.</p> <p>0 - Multicast addressing used at all times. Note: multicast bundles do not transmit data until a receiver is assigned to the same bundle number.</p> <p>1 - Unicast addressing used to single receiver. Multicast addressing used for multiple receivers.</p> <p>0x7FFFFF - Multicast addressing is never used. Maximum number of unicast destinations is set by <i>txMaxUnicast</i>. Receiver request priority is used to determine which receivers are serviced if multiple receivers are assigned to this bundle.</p>
Host Address	0x5n107 (n is 0 based transmitter number)
SNMP Object ID	1.3.6.1.4.1.2680.1.1.7.1.1.10.n (n is 1 based transmitter number)
Type	Integer
Attributes	Read/write - Persistent
Default Value	0x7FFFFF
Implemented Version	2.6.3

Name	txMaxUnicast
Description	<p>Specifies maximum number of unicast destinations supported simultaneously by the transmitter. Receivers in excess of this setting will not receive the bundle.</p> <p>A transmitter can service up to 4 receivers. The number of unicast destinations transmitted to will never exceed this internal capacity limitation.</p> <p>If <i>txUnicastMode</i> is set lower than <i>txMaxUnicast</i>, the bundle will switch to multicast before the limitation on unicast destinations is reached.</p>
Host Address	0x5n108 (n is 0 based transmitter number)
SNMP Object ID	1.3.6.1.4.1.2680.1.1.7.1.1.11.n (n is 1 based transmitter number)
Type	Integer
Attributes	Read/write - Persistent
Default Value	1
Implemented Version	2.8.3

Name	txSubMap
Description	Transmit audio channel (channel within bundle) to audio routing channel (channel of SSI) mapping. This vector contains the routing channel source specifiers per audio channel in the transmitted bundle.
Host Address	0x5n20m (n is 0 based transmitter number, m is 0 based sub-channel number)
Count	8
SNMP Object ID	1.3.6.1.4.1.2680.1.1.7.2.1.2.n .m (n is 1 based transmitter number, m is 1 based audio channel)
Type	Integer
Attributes	Read/write - Persistent
Default Value	First transmitter {1, 2, 3, 4, 5, 6, 7, 8} Second transmitter {9, 10, 11, 12, 13, 14, 15, 16} Third transmitter {17, 18, 19, 20, 21, 22, 23, 24} Fourth transmitter {25, 26, 27, 28, 29, 30, 31, 32}
Implemented Version	2.1.0

Name	txSubFormat
Description	Specifies data format for each sub-channel in the transmitted bundle. Please see Table 6 on page 26 for a complete list of valid format values. <i>modeRateControl</i> must also be set correctly to support the configured format.
Host Address	0x5n30m - 0x5n30m (n is 0 based transmitter number, m is 0 based sub-channel number)
Count	8
SNMP Object ID	1.3.6.1.4.1.2680.1.1.7.2.1.3.n .m (n is 1 based transmitter number, m is 1 based sub-channel number)
Type	Integer
Attributes	Read/write - Persistent
Default Value	0x54000
Implemented Version	2.2.0

7.4.12 Synchronization

Name	syncConductorClock
Description	<p>Selects sample clock source when acting as network conductor.</p> <p>0x0 - Internal mode. See Section 3.4.1 "Internal" on page 17</p> <p>0x1 - External Word Clock mode. See Section 3.4.3 "External Word Clock" on page 17</p> <p>0x4 - External Master Clock mode. See Section 3.4.4 "External Master Clock" on page 17</p> <p>0x10 - Internal with External Sample Synchronization mode. See Section 3.4.2 "Internal with External Sample Synchronization" on page 17</p> <p>0x14 - External Master Clock with External Sample Synchronization mode. See Section 3.4.5 "External Master Clock with External Sample Synchronization" on page 18</p> <p><i>Reference design only:</i> add 0x40 to the clock selection value for hardware utilizing an external clock selection multiplexor.</p>
Host Address	0x60000
SNMP Object ID	1.3.6.1.4.1.2680.1.1.8.1
Type	Integer
Attributes	Read/write - Persistent
Default Value	0
Implemented Version	2.2.1

Name	syncPerformerClock
Description	<p>Selects sample clock source when acting as a performer. Values are the same as documented above for <i>syncConductorClock</i>. External clocks applied must be externally synchronized to the conductor.</p>
Host Address	0x60001
SNMP Object ID	1.3.6.1.4.1.2680.1.1.8.2
Type	Integer
Attributes	Read/write - Persistent
Default Value	0
Implemented Version	2.2.1

Name	syncClockTrim
Description	<p>Allows fine control of clock rate when acting as a network conductor in internal synchronization mode (syncConductorClock = 0x00). Range of control is on the order +/-37PPM A trim value of 0xFFFFFFFF is sufficient for most applications.</p> <p>0xFFFFFFFF - normal 0x800000 - minimum frequency 0x7FFFFFFF - maximum frequency</p> <p>For RAVE only: 0x500000 - normal 0x7FFFFFFF - minimum frequency 0 - maximum frequency</p>
Host Address	0x60002
SNMP Object ID	1.3.6.1.4.1.2680.1.1.8.3
Type	Integer
Attributes	Read/write - Persistent
Default Value	Read from flash configuration record.
Implemented Version	2.2.1

Name	syncBuddyLinkControl
Description	<p>BuddyLink allows two CobraNet interfaces to operate as a redundant pair with fail-over capability. The BuddyLink signal must be synthesized in hardware by ANDing together the FS1 clock and MUTE signals from the primary interface. Presence of this gated clock signal at the REFCLK_IN input of the Secondary unit indicates proper operation of the Primary unit. Mute is asserted (dropped) when a fault is detected by the primary, which then gates off the clock signal to the secondary. As long as the BuddyLink signal is detected by the secondary unit, it will send empty reservation requests preventing the unit from transmitting and, in most cases, receiving audio. When absence of the clock is detected, the secondary will begin transmitting valid reservation packets, thus allowing it to process bundles. An idle secondary unit may still receive multicast bundles. The following values may be OR'd together:</p> <p>0x2 - Disable reference clock input. This master disable feature should be invoked on designs where the reference clock input is not connected. Disabling the reference clock input prevents noise from interfering with operation of the interface.</p> <p>0x4 - Enable BuddyLink. Presence of a clock at REFCLK_IN will disable network transmitters and receivers.</p> <p>0x8 - Force Buddy Link presence. Applicable in secondary BuddyLink interfaces to simulate failure of a primary BuddyLink partner. Enable BuddyLink bit is overridden.</p>
Host Address	0x60003
SNMP Object ID	1.3.6.1.4.1.2680.1.1.8.4
Type	Integer
Attributes	Read/write - Persistent
Default Value	2
Implemented Version	2.4.7

Name	syncStatus
Description	Indicates current audio clock synchronization status. The following values may be ORed together: Unspecified bits should be ignored. 0x01 - Locked to external or network clock reference. 0x02 - Valid clock present at REFCLK_IN. 0x04 - MUTE is not asserted. Indicates proper operation of CobraNet interface as MUTE is asserted on detection of a fault condition or loss of connection to the network.
Host Address	0x61000
SNMP Object ID	1.3.6.1.4.1.2680.1.1.8.5
Type	Integer
Attributes	Read-only
Default Value	n.a.
Implemented Version	Variable implemented 2.5.9. EXTWRDCLKOUT presence indication added 2.6.4.

Name	syncCounter
Description	Incremented each time network sync is lost.
Host Address	0x61001
SNMP Object ID	1.3.6.1.4.1.2680.1.1.8.6
Type	Counter
Attributes	Read-only
Default Value	0
Implemented Version	2.6.5

Name	syncNTime
Description	CobraNet network time. Advances 256 every 1-1/3ms. Network time rolls over after reaching 0xFFFF00 (16,776,960) on 24- and 32-bit platforms.
Host Address	0x61002
SNMP Object ID	1.3.6.1.4.1.2680.1.1.8.7
Type	Integer (Only lower 24 bits are valid. Upper byte is always zero.)
Attributes	Read-only
Implemented Version	2.9.9, 2.10.4

7.4.13 SNMP Monitor

Name	snmpWriteEnable
Description	This variable enables write access to all read-write SNMP variables. 0 - all SNMP variables read-only; write disabled non-zero - writes enabled for read-write SNMP variables
Host Address	0x70000
SNMP Object ID	Not available via SNMP
Type	Integer
Attributes	Read/write - Persistent
Default Value	1
Implemented Version	2.6.3

Name	snmpROCommunity
Description	The community name the SNMP agent requires for reading variables (get and get-next SNMP requests).
Host Address	0x70001
SNMP Object ID	Not available via SNMP
Size	60 characters
Type	DisplayString
Attributes	Read/write - Persistent
Default Value	"public"
Implemented Version	2.6.3

Name	snmpRWCommunity
Description	The community name the SNMP agent requires for writing variables (set SNMP requests). Reading of variables is also allowed using this community name.
Host Address	0x70017
SNMP Object ID	Not available via SNMP
Size	60 characters
Type	DisplayString
Attributes	Read/write - Persistent
Default Value	"private"
Implemented Version	2.6.3

7.4.14 MI Monitor

Name	miMonDirty
Description	Incremented when a management interface variable is modified either via SNMP or HMI. Multiple modifications may result in a single increment of this counter. The act of writing a variable, even if written with its current value, is considered a modification for the purposes of this counter.
Host Address	0x71000
SNMP Object ID	1.3.6.1.4.1.2680.1.1.9.1.1
Type	Counter
Attributes	Read-only
Default Value	0
Implemented Version	2.6.3 (available via SNMP in 2.6.4)

Name	miMonSNMPDirty
Description	Incremented if a management interface variable is modified through SNMP. The counter is intended to allow detection of variable modification by any SNMP manager. Multiple modifications may result in a single increment of this variable. The act of setting a variable, even if set to its current value, is considered a modification for the purposes of this counter.
Host Address	0x71001
SNMP Object ID	1.3.6.1.4.1.2680.1.1.9.1.2
Type	Counter
Attributes	Read-only
Default Value	0
Implemented Version	2.6.5

Name	miMonHMIDirty
Description	Incremented if a management interface variable is modified through HMI. The counter is intended to allow detection of variable modification by a local manager. Multiple modifications may result in a single increment of this variable. The act of writing a variable, even if written with its current value, is considered a modification for the purposes of this counter.
Host Address	0x71002
SNMP Object ID	1.3.6.1.4.1.2680.1.1.9.1.3
Type	Counter
Attributes	Read-only
Default Value	0
Implemented Version	2.6.5

7.4.15 IP Monitor

Name	ipMonCurrentIP
Description	The current IP address for the CobraNet interface. Changing the current IP address has an immediate effect on IP communications. A value of 0.0.0.0 indicates no IP address assignment for the interface. An IP address can be assigned (or reassigned) to the interface by any of the following means: A value loaded from <i>ipMonStaticIP</i> during power-up. A host processor writing to <i>pMonCurrentIP</i> via the HMI. Receipt of a BOOTP response packet (typically in response to a transmitted BOOTP request) Receipt of a RARP response packet (RARP requests are not transmitted)
Host Address	0x72000
SNMP Object ID	1.3.6.1.4.1.2680.1.1.9.2.2
Type	IpAddress
Attributes	Read/Write
Default Value	ipMonStaticIP
Implemented Version	2.6.3

Name	ipMonStaticIP
Description	A power-up static IP address assignment for the interface. A value of 0.0.0.0 indicates no power-up IP address assignment.
Host Address	0x72002
SNMP Object ID	1.3.6.1.4.1.2680.1.1.9.2.1
Type	IpAddress
Attributes	Read/write - Persistent
Default Value	0.0.0.0
Implemented Version	2.8.2

7.4.16 IF Monitor

MI interface for monitoring redundant Ethernet connection (Dual Link) feature. These variables are only available on the CM-1, CM-2 and CS181xx-based hardware.

Name	ifmCurrentIf
Description	Index of the current, active Ethernet connection. 1 - Primary 2 - Secondary On platforms with only one interface, this value will always be one.
Host Address	0x73000
SNMP Object ID	1.3.6.1.4.1.2680.1.1.9.3.1
Type	Integer
Attributes	Read Only
Implemented Version	TBD

Name	ifmLastChange
Description	The value of <i>sysUpTime</i> at the time the <i>ifmCurrentIf</i> was established. If the current state was entered prior to or concurrent with the last re-initialization of the local network management subsystem, then this value will be zero. On platforms with only one interface, this value will always be zero.
Host Address	0x73001
SNMP Object ID	1.3.6.1.4.1.2680.1.1.9.3.2
Type	Time Ticks
Attributes	Read Only
Implemented Version	TBD

Name	ifmSwitchMode
Description	Controls DualLink behavior. This variable applies only to interfaces which support two Ethernet ports. 0 - Automatic switchover to secondary on failure of primary. 1 - Always use primary port. 2 - Always use secondary port. 3 - If one port is working properly and the other has failed, switch to the port that is working properly. If both are working properly or both have failed, do not change ports. On boot, start with the primary port. On platforms with only one interface, a value of "3" is ignored.
Host Address	0x73100
SNMP Object ID	1.3.6.1.4.1.2680.1.1.9.3.4
Type	Integer
Attributes	Read/Write
Implemented Version	2.9.9

Name	ifmtStatus
Description	Status of Ethernet connection. The following values may be OR'd together: 1 - Ethernet link established 2 - Connection is full-duplex 4 - Ethernet packets being received at a rate of at least 1 packet every two seconds.
Host Address	0x74n00 where: n = 0 = primary Ethernet interface n = 1 = secondary Ethernet interface
SNMP Object ID	1.3.6.1.4.1.2680.1.1.9.3.3.1.2.n
Count	2
Type	Integer
Attributes	Read Only
Implemented Version	2.9.9

Name	ifmtLastChange
Description	The value of <i>sysUpTime</i> at the time <i>ifmtStatus</i> was established. If the current state was entered prior to or concurrent with the last re-initialization of the local network management subsystem, then this object contains a zero value.
Host Address	0x74n01 where: n = 0 = primary Ethernet interface n = 1 = secondary Ethernet interface
SNMP Object ID	1.3.6.1.4.1.2680.1.1.9.3.3.1.3.n
Count	2
Type	Time Ticks
Attributes	Read Only
Implemented Version	2.9.9

8. Recommended User Interface Practices

8.1 Channel Assignments and Labeling

There are at least five layers where audio channels are numbered:

- User labels on the back panel of a device.
- As synchronous serial time slot and interface assignments. This is determined by how the audio I/O is physically connected and multiplexed.
- As audio buffer offsets within the CobraNet interface. There is a fixed mapping between the time slot and interface assignments and the audio buffer offsets for each basic CobraNet I/O configuration supported.
- As audio routing channels within the CobraNet interface. Valid routing channels are in the range 1-64. Channel 0 is reserved to indicate an unused channel. The mapping between I/O indices and audio buffer offsets is determined by the *audioMap* MI variable.
- As bundle and audio channel assignments. Valid bundle numbers are 1-65535. Bundle 0 indicates an unused transmitter or receiver. A bundle may carry up to 8 audio channels. Routing channels are assigned to bundles through the *txSubMap* and *rxSubMap* MI variables.

8.1.1 Audio I/O Map

The *audioMap* variables may need to be set up by the manufacturer. Audio inputs starting from the channel labeled 1 should be assigned starting at routing channel 1. Audio outputs starting from the channel labeled 1 should be assigned starting at routing channel 33. The *audioMap* values may be initialized through firmware customization or the HMI.

8.1.2 Bundle Assignments

It is recommended that all front panel interfaces allow selection of multicast bundles in the range 1-255 and unicast bundles in the range 256-65279. We recommend against allowing private bundle assignments from a front panel user interface since these are conditioned on a 48-bit MAC address. Private bundle assignments are best left to a central graphical user interface operating via SNMP.

Transmitters—Audio channels are transmitted in groups of up to 8 onto the network via a bundle. It is an advisable policy to pack as many audio channels into a bundle as possible as this improves network efficiency. This does strategy does not necessarily limit routing flexibility as complex routing functionality can be readily accomplished at the receiver side. At a minimum, user control of bundle assignments per network transmitter should be provided. Optional user interface control of transmitter functionality may include any combination of the following:

- Audio Resolution on a per-audio-channel Basis
- Audio Source Channel Mapping per Transmitter Audio Channel
- Number of Audio Channels to Include in Bundle Transmission
- Bundle and Request Priority

Receivers—The receiver can extract up to 8 audio channels from a bundle. The receiver decodes the data according to the tags attached to the bundle by the transmitter. At a minimum, user control of the bundle assignment per network receivers should be

provided. Optional user interface control of receiver functionality may include any combination of the following:

- Audio destination channel mapping per receiver audio channel
- Bundle and request priority

8.2 Conductor Priority

It is not necessary to give users the ability to change conductor priority via a front panel interface. If manipulation of conductor priority is desired, allowing three options with regard to conductor priority selection is recommended:

- Never - conductorPriority = 0
- Normal - conductorPriority = 32
- High - conductorPriority = 128

8.3 Name

Users should be able to either select and display or simply display a network name for the device. This network name is stored in the `sysName` management variable as an ASCII string that is 4 to 16 characters in length. a-z, A-Z, 0-9 and - [hyphen] are allowed characters. Names are not case sensitive. A name may be as simple as 4 numeric characters. A set of thumb wheel switches can be used to provide a unique numerical name. Names containing only 0's (zeros) and "NONAME" are reserved names indicating that no name has been assigned to the unit.

9. Error Reporting

9.1 Recoverable Errors

Recoverable errors are indicated by an increment of *errorCount*, update of *errorCode*, *errorIndicators* and illumination of the TX error, RX error and/or Fault indicators, if available. Note that some CobraNet devices do not present all indicators to the user. For example, the CM-1 provides only the Fault indicator. There are numerous recoverable error conditions that can cause an error indication. It is possible to determine the exact cause of the most recently reported error conditions by reading the *errorCode* variable through the management interface.

9.1.1 Receive and Transmit Errors

Receive and transmit errors illuminate the RX Error and/or TX Error indicators. These errors are reported with respect to the Ethernet interface. An RX error indicates trouble receiving audio or control data from the network. A TX error indicates trouble transmitting audio or control data onto the network. These errors may originate at peripherals attached to the CobraNet interface. A framing error detected at the asynchronous serial port is reported as a TX error because an inability to correctly receive asynchronous serial data means that it can't be properly *transmitted* onto the Ethernet. Difficulty locking to the conductor clock is reported by simultaneous illumination of the RX error and TX error indicators as a failure to lock affects both transmission and reception.

9.1.2 Faults

Illumination of the Fault indicator indicates detection of an unexpected condition. Some fault conditions will also light the RX error and/or TX error indicators to give more specific indication if the unexpected condition is in the receive or transmit processes.

9.2 Unrecoverable Errors

9.2.1 Fatal Faults

A fatal fault halts the CobraNet interface. Audio and control data delivery is suspended while an error code is displayed as a flashing pattern on the Fault indicator. Once the code has been displayed several times, the interface will automatically attempt to reset itself.

The fatal fault code is displayed as a repeating set of three flash sequences. These three flash sequences represent three digits of an octal error code. A single flash represents a 0 digit and 8 flashes represent a 7 digit. The three digits are delivered least significant first. Convert from octal to decimal and divide by two to get the error code. Or the flash sequences may be looked up directly in the Error Codes section of this document

As an example, a repeating pattern of 5 flashes then 2 flashes followed by 3 flashes represents an octal code of 214. Converting to decimal and dividing by 2 yields error code 70.

9.2.2 POST Failure

Power on self-tests are performed during the boot process. If one of these tests fails, an error code is displayed as a flashing pattern on the Fault indicator. Once the code has been displayed, the interface is automatically attempt to reset itself. Typically the same test will fail again resulting in repeated display of the failing error code.

Table 16. POST Failure Error Codes

Number of Fault Indicator Flashes	Failed Test
1	Runtime code checksum error
2	Boot code checksum error
3	Xilinx configuration load failure
4	Error in MAC register access
5	Data error in PHY register access
6	Timeout error in PHY register access
8	SRAM error: bank 0 LS byte
9	SRAM error: bank 0 middle byte
10	SRAM error: bank 0 MS byte
11	SRAM error: bank 1 LS byte
12	SRAM error: bank 1 middle byte
13	SRAM error: bank 1 MS byte
14	Address or data bus data dependent failure
15	Ethernet loopback test failure
19	Unexpected interrupt occurred
20	Unexpected Xilinx configuration identification
21	Unexpected Xilinx configuration version
22	Sample clock range test failure
23	Sample clock not running

10. Error Code Reference

10.1 Legend

32-bit Code - Error code as reported on 32-bit platforms (CS181xx and CM-2)

24-bit Code - Error code as reported on 24-bit platforms (Reference designs and CM-1)

Flash Code - Code as reported in a fatal fault situation. Flash codes are typically only displayed for fatal errors.

Type - Classification and behavior of the error condition.

Table 17. Error Types

Type	Description
TX	Recoverable and expected transmit error
TXQUIET	Informative transmit incident
TXFAULT	Unexpected but recoverable transmit error
RX	Recoverable and expected receive error
RXQUIET	Informative receive incident
RXFAULT	Unexpected but recoverable receive error
TXRX	Recoverable and expected error simultaneously affecting transmit and receive
FAULT	Unexpected but recoverable error
FATAL	Unrecoverable error condition. Reported as a flash code on the fault indicator.

Name - Name assigned to the error by the firmware programmer.

Description - Description of the error condition.

Expected Conditions - Foreseeable conditions under which the error condition would occur on normally functioning and properly connected hardware.

Unexpected Conditions - Conditions indicating a hardware or firmware fault.

10.2 Error Code Interpretation

24-bit and 32-bit interfaces present their error codes differently. For 24-bit interfaces (reference design and CM-1) the decimal error code presented will fall within the ranges shown in the *24-bit Code* column of the *Error Codes* table and may be looked up directly.

For 32-bit interfaces (CM-2, CS181xx) the *Byte Code* must be extracted from the returned value. The same *Byte Code* is also valid for 24-bit interfaces but is extracted from the error code differently than for 32-bit interfaces.

10.2.1 Extraction of Byte Code for 32-bit Interfaces

- 1) Convert the decimal error code to Hexadecimal. This will yield a 3 or 4 digit value.
- 2) Use the 2 least significant digits to look up the code in the *Byte Code* column.

For example:, a returned code of 2133 = 0x855 in Hexadecimal. Looking up 0x55 Hexadecimal (0x55 Hex also equals 85 decimal) reveals that an Ethernet transmission error occurred where the interface failed to detect a carrier.

10.2.2 Optional Extraction of Byte Code for 24-bit Interfaces

- 1) Convert the decimal error code to Hexadecimal. When displayed, the value may be less than 6 Hex digits. Any missing leading digit is implied to equal zero.
- 2) Use the Most significant 2 digits, remembering that there could be an implied 0.

For example: A returned code of 262144 = 0x40000 in Hexadecimal. Taking the most significant 2 digits = 0x04. The leading 0 is implied as the Hexadecimal translation yields only 5 digits. Looking up 0x04 (0x04 Hex also equals 4 decimal) reveals that the Ethernet interface could not be accessed.

10.3 Error Codes Listing

Byte Code	24-bit Code	Flash Code	Type	Name	Description	Expected Conditions	Unexpected Conditions
0 0x00	0-65535	1,1,1	NONE	NO ERROR	No error has been reported.	-	-
1 0x01	65536-131071	1	POST	NO CODE	No valid runtime code to load from flash memory.	No code has ever been loaded in the flash.	Corrupted flash contents. Hardware failure in flash memory or address/data bus.
2 0x02	131072-196607	2	POST	BOOT CSUM	Bad boot sector checksum.	-	Corrupted flash contents. Hardware failure in flash memory or address/data bus.
3 0x03	196608-262143	3	POST	XILINX CONFIG	Xilinx configuration load failure.	-	Hardware problem with Xilinx PLD or configuration interface. Corrupted Xilinx configuration file in flash.
4 0x04	262144-327679	4	POST	POST MAC	Ethernet media access controller (MAC) register access failure.	-	Problem with Ethernet MAC or MAC <-> DSP interface.

Byte Code	24-bit Code	Flash Code	Type	Name	Description	Expected Conditions	Unexpected Conditions
5 0x05	327680- 393215	5	POST	POST PHY DATA	Ethernet physical interface (PHY) register access failure. Data read does not match data written.	-	Problem with PHY, Ethernet MAC or MAC <-> PHY interface (MII).
6 0x06	393216- 458751	6	POST	POST PHY TIMEOUT	PHY register access failure. PHY did not respond to read or write request.	-	Problem with PHY, MAC or MAC <-> PHY interface (MII).
8 0x08	524288- 589823	8	POST	POST B0L	Main memory failure; low byte, main bank.	-	Memory chip problem. Data bus problem. Address bus problem.
9 0x09	589824- 655359	9	POST	POST B0M	Memory failure; middle byte, main bank.	-	Memory chip problem. Data bus problem. Address bus problem.
10 0x0A	655360- 720895	10	POST	POST B0H	Memory failure; high byte, main bank.	-	Memory chip problem. Data bus problem. Address bus problem.
11 0x0B	720896- 786431	11	POST	POST B1L	Memory failure; low byte, high bank.	-	Memory chip problem. Data bus problem. Address bus problem.
12 0x0C	786432- 851967	12	POST	POST B1M	Memory failure; middle byte, high bank.	-	Memory chip problem. Data bus problem. Address bus problem.
13 0x0D	851968- 917503	13	POST	POST B1H	Memory failure; high byte, high bank.	-	Memory chip problem. Data bus problem. Address bus problem.
14 0x0E	917504- 983039	14	POST	POST BUS	Address/data bus test failure during bus stress test.	-	Address and/or data bus performance is marginal.
15 0x0F	983040- 1048575	15	POST	POST LOOPBACK	Ethernet physical interface (PHY) loopback test failure. Cannot transmit and receive packet correctly.	-	Problem with Ethernet controller (MAC or PHY). Problem with Ethernet DMA (PLD).

Byte Code	24-bit Code	Flash Code	Type	Name	Description	Expected Conditions	Unexpected Conditions
16 0x10	1048576- 1114111	1,5,1	FAULT	FLASH FAILURE	Failure during flash erase or write operation.	Flash device has fatigued due to excessive write/erase operations.	Problem with flash device or flash <-> DSP interface.
17 0x11	1114112- 1179647	3,5,1	FAULT	FLASH WRITE	Attempt to program flash location before erase.	-	Flash erase failure.
18 0x12	1179648- 1245183	5,5,1	FATAL	BAD CONFIG	Bad configuration record in flash	No configuration parameters specified during boot bank programming and an existing configuration record could not be found.	The configuration record does not match the main code. Either the flash is improperly programmed or there is a problem with the flash bank selection logic or other address decode logic.
19 0x13	1245184- 1310719	7,5,1	FAULT	INT UNEXPECTED	Interrupt occurred while interrupts were disabled.	-	-
20 0x14	1310720- 1376255	1,6,1	FATAL	XILINX ID	Xilinx does not report expected identification.	-	Problem with Xilinx PLD. Problem with Xilinx configuration file in flash.
21 0x15	1376256- 1441791	21	POST	XILINX VERSION	Reported Xilinx version not supported by boot code.	-	Mismatched files used during code build.
22 0x16	1441792- 1507327	22	POST	POST CLOCK RANGE	Sample clock pull range test failure. The voltage controlled sample clock crystal oscillator (VCXO) pull range does not meet minimum requirements.	-	The VCXO device does not meet specification. Problem with VCXO control voltage circuitry.
23 0x17	1507328- 1572863	23	POST	POST CLOCK STOPPED	Sample clock not running. Timeout waiting for measurement edge.	-	VCXO is not oscillating. Problem with FS1 circuitry or PLD.

Byte Code	24-bit Code	Flash Code	Type	Name	Description	Expected Conditions	Unexpected Conditions
24 0x18	1572864- 1638399	1,7,1	FATAL	UNUSED	-	-	-
26 0x1A	1703936- 1769471	5,7,1	FATAL	UNUSED	-	-	-
28 0x1C	1835008- 1900543	1,8,1	FATAL	UNUSED	-	-	-
30 0x1E	1966080- 2031615	5,8,1	FATAL	UNUSED	-	-	-
32 0x20	2097152- 2162687	1,1,2	TXRX	CYCLES	DSP processing cycles exhausted.	Broadcast storm in progress on network.	Processor running slow. Sample clock running fast. DMA controller malfunctioning. Unable to acknowledge an interrupt.
33 0x21	2162688- 2228223	3,1,2	RX	RX STORM	Broadcast storm detected.	Loop in network producing overwhelming amount of broadcast or multicast network traffic.	-
34 0x22	2228224- 2293759	5,1,2	RX	BEAT FLOODED	Beat packet received while previous beat packet still being processed.	Occurs normally while synchronizing to the network. Late collisions on an oversized (>200 meter) repeater network are occurring profusely. multiple units may be conducting in this scenario.	Conductor is misbehaving.
35 0x23	2293760- 2359295	7,1,2	TX	BAD HANDLE	Out of range permission handle received in beat packet.	-	Conductor is misbehaving.
36 0x24	2359296- 2424831	1,2,2	TX	TX TOO BIG	Attempt to generate an oversize outgoing packet.	Too many 24 bit audio channels specified for transmitter.	-
37 0x25	2424832- 2490367	3,2,2	FATAL	INTREENTER ED	Unexpected interrupt service routine reentry.	-	Processor running slow. Sample clock running fast.

Byte Code	24-bit Code	Flash Code	Type	Name	Description	Expected Conditions	Unexpected Conditions
38 0x26	2490368- 2555903	5,2,2	TX	ETXUNEXPEC TED	Unexpected Ethernet transmit complete interrupt; no transmit in progress.	Collisions occurring on repeater network.	-
39 0x27	2555904- 2621439	7,2,2	TXRX	LOST LOCK	Lost lock to network clock.	Initial synchronizati on to the network. Change of conductor. Conductor is attempting to synchronize to bad external reference clock.	Sample clock crystal of either this unit or the conductor does not meet specification.
40 0x28	2621440- 2686975	1,3,2	RX	EARLY PACKET	Received an audio packet with eager timestamp.	Excessive delay variation through the network.	-
41 0x29	2686976- 2752511	3,3,2	FAULT	FRAME ASSERTFAIL	Programmer assertion failed in frame.asm	-	-
42 0x2A	2752512- 2818047	5,3,2	TXFAULT	QUEUEPUT BEATDISCAR DS	Packet queue overflow discarding un- transmitted packets.	-	-
43 0x2B	2818048- 2883583	7,3,2	TX	QUEUEGET TXFREE	Free transmit buffers exhausted.	A unit is kept from transmitting because network bandwidth is exhausted.	-
44 0x2C	2883584- 2949119	1,4,2	FATAL	FLASHREQ ASSERTFAIL	Programmer assertion failed in flashreq.asm	-	-
45 0x2D	2949120- 3014655	3,4,2	RX	QUEUEPUT RXCONTROL	Too many control packets received.	Excessive broadcast control traffic on network.	-
46 0x2E	3014656- 3080191	5,4,2	RX	QUEUEPUT RX	Too much audio data received for a network isochronous channel.	-	Two devices are mistakenly transmitting onto the same bundle.
47 0x2F	3080192- 3145727	7,4,2	RX	QUEUEPUT RXPACKETS	Receive packets backlogged.	Excessive broadcast traffic on network.	-

Byte Code	24-bit Code	Flash Code	Type	Name	Description	Expected Conditions	Unexpected Conditions
48 0x30	3145728- 3211263	1,5,2	TX	QUEUEPUT TX	Packet queue overflow at bundle transmitter.	A unit is kept from transmitting because network bandwidth is exhausted.	-
49 0x31	3211264- 3276799	3,5,2	TXFAULT	QUEUEPUT TXFREE	Packet queue overflow while freeing a transmit buffer.	-	Freed a buffer twice.
50 0x32	3276800- 3342335	5,5,2	TXFAULT	QUEUEPUT TXPACKETS	Transmit packets backlogged.	-	-
51 0x33	3342336- 3407871	7,5,2	FAULT	IPBUF FREETWICE	Freed the same IP buffer twice.	-	-
52 0x34	3407872- 3473407	1,6,2	RX	RXBUFFER OVERFLOW	Receive buffers exhausted.	Excessive broadcast traffic on network. Setting of rxMinDelay is too high. Excessive delay variation through network.	-
53 0x35	3473408- 3538943	3,6,2	TXFAULT	SSIRX OVERRUN	Synchronous serial (SSI) audio data receive overrun.	-	Excessive interrupt latency.
54 0x36	3538944- 3604479	5,6,2	RXFAULT	SSITX UNDERRUN	Synchronous serial (SSI) audio data transmit underrun.	-	Excessive interrupt latency.
55 0x37	3604480- 3670015	7,6,2	FATAL	EXTSTACK OVER	Processor external stack overflow.	-	-
56 0x38	3670016- 3735551	1,7,2	FATAL	EXTSTACK UNDER	Processor external stack underflow.	-	-
57 0x39	3735552- 3801087	3,7,2	TX	TX CHANCOUNT	Unable to transmit all outbound audio packets within an isochronous cycle period.	Bandwidth is exhausted on a repeater network.	-
58 0x3A	3801088- 3866623	5,7,2	TXFAULT	QUEUEPUT ORDER	Queue overflow preparing packets for transmission.	-	-

Byte Code	24-bit Code	Flash Code	Type	Name	Description	Expected Conditions	Unexpected Conditions
59 0x3B	3866624- 3932159	7,7,2	FATAL	UNUSED	-	-	-
60 0x3C	3932160- 3997695	1,8,2	TXQUIET	TXAUDIO DROPOUT	Audio dropout occurred on transmission.	Conductor revoked permission, channel number changed or turned off by user. A beat packet did not arrive either due to a conductor change or a problem on the network.	-
61 0x3D	3997696- 4063231	3,8,2	RXQUIET	RXAUDIO DROPOUT	Audio dropout occurred on reception.	Conductor revoked permission, channel number changed or turned off by user. Audio packet was dropped by the network.	-
62 0x3E	4063232- 4128767	5,8,2	TXFAULT	TXFREE TWICE	A transmit buffer was freed twice.	-	-
63 0x3F	4128768- 4194303	7,8,2	RXFAULT	RXPACKET BOUNDS	DMA reports receiving an packet outside designated receive buffer address range.	-	DMA hardware is misbehaving.
64 0x40	4194304- 4259839	1,1,3	TX	QUEUEPUT SCICRX	Serial bridge can't packetize and transmit characters as fast as they're being received from the serial port.	serialPPeriod setting too high for selected baud rate.	-
65 0x41	4259840- 4325375	3,1,3	FATAL	IP ASSERTFAIL	Programmer assertion failure in ip.asm	-	-

Byte Code	24-bit Code	Flash Code	Type	Name	Description	Expected Conditions	Unexpected Conditions
66 0x42	4325376- 4390911	5,1,3	FATAL	QUEUEPUT FLASHREQ	Queue overflow initiating a flash read, write or erase.	-	A request has been resubmitted before it was completed. Flash request queue size needs to be increased due to software expansion.
67 0x43	4390912- 4456447	7,1,3	FATAL	PROCSTACK OVER	Processor internal stack overflow.	-	-
68 0x44	4456448- 4521983	1,2,3	FATAL	PROCSTACK UNDER	Processor internal stack underflow.	-	-
69 0x45	4521984- 4587519	3,2,3	TX	DUP MAC	Duplicate MACs detected on network detected during conductor arbitration. MAC addresses are supposed to be globally unique. The two (or more) units may not be able to resolve this conflict peacefully.	Loop in network resulting in broadcast storm and subsequent receipt of own beat packets.	-
70 0x46	4587520- 4653055	5,2,3	FATAL	STACK CORRUPT	Processor external stack corrupted.	-	-
71 0x47	4653056- 4718591	7,2,3	FATAL	UNUSED	-	-	-
72 0x48	4718592- 4784127	1,3,3	FATAL	TXFREE CORRUPT	A transmit buffer was modified after being freed.	-	-
73 0x49	4784128- 4849663	3,3,3	RX	QUEUEPUT SCITXC	Serial bridging received more characters from the network faster than it can transmit them out the serial port. from SCI.	Characters are being received simultaneously over the network from two transmitters. Baud rate at transmitter is set higher than at receiver.	-

Byte Code	24-bit Code	Flash Code	Type	Name	Description	Expected Conditions	Unexpected Conditions
74 0x4A	4849664- 4915199	5,3,3	RXQUIET	RXIDLE	Loss of receive activity detected.	There are no longer any other CobraNet devices on the network.	-
75 0x4B	4915200- 4980735	7,3,3	FATAL	UNUSED	-	-	-
77 0x4D	5046272- 5111807	3,4,3	FATAL	ILLEGAL INST	Illegal instruction encountered.	-	Hardware problem with main memory or address/ data busses.
78 0x4E	5111808- 5177343	5,4,3	FATAL	UNUSED	-	-	-
79 0x4F	5177344- 5242879	7,4,3	RX	ETHERRX OVERRUN	Could not keep up with Ethernet receive data transfer requirements.	Ethernet receive data transfers deferred by transmissions.	Problem with Ethernet receive DMA.
80 0x50	5242880- 5308415	1,5,3	RX	ETHERRX CRC	Corrupted Ethernet packet received (CRC error).	Late collisions on an oversized (>200 meter) repeater network. Cabling, equipment or electromagnetic interference problem on the network. A cut-through switch may convert collision fragments into packets with bad CRC.	Problem with Ethernet controller.
81 0x51	5308416- 5373951	3,5,3	RX	ETHERRX DRIBBLE	Received packet with incomplete last byte.	Cabling, equipment or electromagnetic interference problem on the network. Late collisions on an oversized (>200 meter) repeater network.	Problem with Ethernet controller.
82 0x52	5373952- 5439487	5,5,3	RX	ETHERRX BIGPACKET	Received an illegally large packet.	Equipment problem on the network.	-

Byte Code	24-bit Code	Flash Code	Type	Name	Description	Expected Conditions	Unexpected Conditions
83 0x53	5439488- 5505023	7,5,3	TX	ETHERTX UNDER	Could not keep up with Ethernet transmit data requirements.	Late collisions on an oversized (>200 meter) repeater network disrupt transmit in progress leading to this condition	Problem in Ethernet DMA.
84 0x54	5505024- 5570559	1,6,3	TX	ETHERTX 16COLL	16 successive collisions on transmission attempt; transmission aborted.	-	Repeater network is saturated with traffic. problem with collision detection mechanism in the Ethernet controller.
85 0x55	5570560- 5636095	3,6,3	TX	ETHERTX CRS	Ethernet carrier sense did not assert in response to transmission.	May be reported if transmission is in progress when Ethernet is disconnected.	-

Byte Code	24-bit Code	Flash Code	Type	Name	Description	Expected Conditions	Unexpected Conditions
86 0x56	5636096- 5701631	5,6,3	TXQUIET	ETHERTX LATECOLL	Late collision occurred during transmission.	Late collisions can occur on a repeater network if network diameter exceeds 200 m. CobraNet's collision avoidance mechanism for repeaters allows network diameters up to 2 km. On such networks, late collisions are expected in transmission of control data. This could indicate that the collision detection mechanism of a device is inoperative or a device is mistakenly manually configured for full-duplex operation on a repeater network.	-
87 0x57	5701632- 5767167	7,6,3	RXQUIET	ETHERRX SHORTPACKET	Received an illegally short Ethernet packet.	Collisions are occurring on the network.	A transmitter on the network is misbehaving. Problem with Ethernet controller.
88 0x58	5767168- 5832703	1,7,3	TX	SCI RXOVER	Asynchronous serial receive overrun error.	Bad serial baud rate selected.	-
89 0x59	5832704- 5898239	3,7,3	FATAL	UNUSED	-	-	-
90 0x5A	5898240- 5963775	5,7,3	TX	SCI RXFRAMING	Asynchronous serial receive framing error.	Wrong serial data format or baud rate selected.	-
91 0x5B	5963776- 6029311	7,7,3	FATAL	UNUSED	-	-	-
93 0x5D	6094848- 6160383	3,8,3	RXFAULT	RXPACKET TOOLONG	DMA reports receiving an illegally long packet.	-	Ethernet DMA misbehaving or incorrect handling of receive discard or late collision condition.

Byte Code	24-bit Code	Flash Code	Type	Name	Description	Expected Conditions	Unexpected Conditions
94 0x5E	6160384- 6225919	5,8,3	TX	TRANSMITTING	Attempt to transmit while we're already transmitting.	May be reported during synchronization to network conductor.	-
95 0x5F	6225920- 6291455	7,8,3	TXFAULT	UNPREPARED	Transmitted a packet before it was fully prepared.	-	-
96 0x60	6291456- 6356991	1,1,4	TXFAULT	ALREADY PREPARED	Prepared a packet for transmission that was already previously prepared.	-	-
97 0x61	6356992- 6422527	3,1,4	TXFAULT	ALREADY UNPREPARED	Unprepared a packet for transmission that was already Unprepared.	-	-
98 0x62	6422528- 6488063	5,1,4	TXFAULT	QUEUEPUT TXRECYCLE	Queue overflow discarding or recycling an un-transmitted packet.	-	-
99 0x63	6488064- 6553599	7,1,4	FATAL	BEAT ASSERTFAIL	Programmer assertion failed in beat.asm	-	-
100 0x64	6553600- 6619135	1,2,4	FATAL	UNUSED	-	-	-
102 0x66	6684672- 6750207	5,2,4	TX	BEAT BUSY	Beat packet is still being updated when it is time to transmit it.	Transmission is protracted on loss of link.	A task is not running or processor cycles exhausted.
103 0x67	6750208- 6815743	7,2,4	FATAL	SNMP ASSERTFAIL	Programmer assertion failed in snmp.a	-	-
104 0x68	6815744- 6881279	1,3,4	FATAL	UNUSED	-	-	-
106 0x6A	6946816- 7012351	5,3,4	FATAL	UNUSED	-	-	-
108 0x6C	7077888- 7143423	1,4,4	FATAL	UNUSED	-	-	-
110 0x6E	7208960- 7274495	5,4,4	FATAL	UNUSED	-	-	-
111 0x6F	7274496- 7340031	7,4,4	FAULT	ORDER MISMATCH	Inconsistency detected in transmission queues.	-	-

Byte Code	24-bit Code	Flash Code	Type	Name	Description	Expected Conditions	Unexpected Conditions
112 0x70	7340032- 7405567	1,5,4	FATAL	UNUSED	-	-	-
114 0x72	7471104- 7536639	5,5,4	RX	NO BEAT HEADER	Could not find header section in beat packet.	-	Conductor has transmitted an ill formed beat packet.
115 0x73	7536640- 7602175	7,5,4	RX	NO ISO HEADER	Could not find header section in isochronous data packet.	Device has transmitted an ill formed isochronous data packet	-
116 0x74	7602176- 7667711	1,6,4	FATAL	UNUSED	-	-	-
117 0x75	7667712- 7733247	3,6,4	TX	BRIDGE TX SIZE	Packet bridge transmission is too big (>1514 bytes) or too small (<14 bytes).	Host processor has specified a size out of range.	-
118 0x76	7733248- 7798783	5,6,4	TXQUIET	HMI ADDRESS INVALID	Invalid host MI address specified.	Host processor lost its mind or assumes a different MI version.	-
119 0x77	7798784- 7864319	7,6,4	TXFAULT	QUEUEPUT TXCONTROL	Queue overflow transmitting control packets.	-	-
120 0x78	7864320- 7929855	1,7,4	FAULT	SSIPTR SLIP	Unexpected audio DMA pointer location.	-	Problem with audio DMA. Problems with audio clocks. Possible contention of clock signals with external connections.
121 0x79	7929856- 7995391	3,7,4	RX	SCIDATA MISSING	Serial bridge packet contained no data section.	-	Malformed packet transmitted by another station or packet was truncated on receipt.
122 0x7A	7995392- 8060927	5,7,4	FAULT	FRAME FLOODED	Frame advance processing not completed before beginning of next frame.	-	-
123 0x7B	8060928- 8126463	7,7,4	TX	ORDER LOCKED	Transmit packets not available at transmission time.	Synchronizatio n to network scenario.	-

Byte Code	24-bit Code	Flash Code	Type	Name	Description	Expected Conditions	Unexpected Conditions
124 0x7C	8126464- 8191999	1,8,4	FATAL	UNUSED	-	-	-
126 0x7E	8257536- 8323071	5,8,4	RX	SECTIONLEN GTH UNEXPECTED	Unexpected packet structure encountered.	Defective transmitter may spew corrupt packets	-
127 0x7F	8323072- 8388607	7,8,4	RXFAULT	ETHERRX ABORT	Unexpected packet receipt aborted; receive abort mechanism unimplemented	-	-
128 0x80	8388608- 8454143	1,1,5	RX	ETHERRX INTERNAL	Internal receive error reported Ethernet controller (MAC).	Accompanies receiver data overrun in some cases. Ethernet receive data transfers deferred by transmissions.	Problem in Ethernet receive DMA.
129 0x81	8454144- 8519679	3,1,5	RX	IP DROPPED	IP packet dropped on receive.	IP packets arriving more frequently than they can be processed.	-
130 0x82	8519680- 8585215	5,1,5	FATAL	UNUSED	-	-	-
131 0x83	8585216- 8650751	7,1,5	RX	SNMP NOPARSE	Unable to parse SNMP packet.	Ill-formed SNMP packet transmitted by a manager.	-
170 0xAA	11141120- 11206655	5,3,6	TXFAULT	PROTOCOL INCOMPATIBL E	Incompatible CobraNet protocol version detected on network.	At least one version 1 CobraNet protocol device on network.	-

Contacting Cirrus Logic Support

For all product questions and inquiries contact a Cirrus Logic Sales Representative.
To find the one nearest to you go to www.cirrus.com

IMPORTANT NOTICE

"Preliminary" product information describes products that are in production, but for which full characterization data is not yet available. Cirrus Logic, Inc. and its subsidiaries ("Cirrus") believe that the information contained in this document is accurate and reliable. However, the information is subject to change without notice and is provided "AS IS" without warranty of any kind (express or implied). Customers are advised to obtain the latest version of relevant information to verify, before placing orders, that information being relied on is current and complete. All products are sold subject to the terms and conditions of sale supplied at the time of order acknowledgment, including those pertaining to warranty, patent infringement, and limitation of liability. No responsibility is assumed by Cirrus for the use of this information, including use of this information as the basis for manufacture or sale of any items, or for infringement of patents or other rights of third parties. This document is the property of Cirrus and by furnishing this information, Cirrus grants no license, express or implied under any patents, mask work rights, copyrights, trademarks, trade secrets or other intellectual property rights. Cirrus owns the copyrights associated with the information contained herein and gives consent for copies to be made of the information only for use within your organization with respect to Cirrus integrated circuits or other products of Cirrus. This consent does not extend to other copying such as copying for general distribution, advertising or promotional purposes, or for creating any work for resale.

CERTAIN APPLICATIONS USING SEMICONDUCTOR PRODUCTS MAY INVOLVE POTENTIAL RISKS OF DEATH, PERSONAL INJURY, OR SEVERE PROPERTY OR ENVIRONMENTAL DAMAGE ("CRITICAL APPLICATIONS"). CIRRUS PRODUCTS ARE NOT DESIGNED, AUTHORIZED OR WARRANTED FOR USE IN AIRCRAFT SYSTEMS, MILITARY APPLICATIONS, PRODUCTS SURGICALLY IMPLANTED INTO THE BODY, LIFE SUPPORT PRODUCTS OR OTHER CRITICAL APPLICATIONS (INCLUDING MEDICAL DEVICES, AIRCRAFT SYSTEMS OR COMPONENTS AND PERSONAL OR AUTOMOTIVE SAFETY OR SECURITY DEVICES). INCLUSION OF CIRRUS PRODUCTS IN SUCH APPLICATIONS IS UNDERSTOOD TO BE FULLY AT THE CUSTOMER'S RISK AND CIRRUS DISCLAIMS AND MAKES NO WARRANTY, EXPRESS, STATUTORY OR IMPLIED, INCLUDING THE IMPLIED WARRANTIES OF MERCHANTABILITY AND FITNESS FOR PARTICULAR PURPOSE, WITH REGARD TO ANY CIRRUS PRODUCT THAT IS USED IN SUCH A MANNER. IF THE CUSTOMER OR CUSTOMER'S CUSTOMER USES OR PERMITS THE USE OF CIRRUS PRODUCTS IN CRITICAL APPLICATIONS, CUSTOMER AGREES, BY SUCH USE, TO FULLY INDEMNIFY CIRRUS, ITS OFFICERS, DIRECTORS, EMPLOYEES, DISTRIBUTORS AND OTHER AGENTS FROM ANY AND ALL LIABILITY, INCLUDING ATTORNEYS' FEES AND COSTS, THAT MAY RESULT FROM OR ARISE IN CONNECTION WITH THESE USES.

Cirrus Logic, Cirrus, the Cirrus Logic logo designs, CobraNet, and CobraCAD are trademarks of Cirrus Logic, Inc. All other brand and product names in this document may be trademarks or service marks of their respective owners.

I²C is a registered trademark of Philips Semiconductor. Purchase of I²C Components of Cirrus Logic, Inc., or one of its sublicensed Associated Companies conveys a license under the Philips I²C Patent Rights to use those components in a standard I²C system.