

---

**MSM9000B-xx**

---

**DOT MATRIX LCD CONTROLLER**

---

**GENERAL DESCRIPTION**

The MSM9000B-xx is a dot-matrix LCD control driver which has functions of displaying 12 (5 x 7 dots) characters (2 lines) and 120-dot arbitrators.

The MSM9000B-xx is provided with a 16-dot common driver, 60-dot segment driver, Display Data RAM (DDRAM), and Character Generator ROM (CGROM).

This device can be controlled with commands entered through the serial interface or parallel interface.

The font data in the CGROM can be changed by mask option.

Since the MSM9000B-xx has an LCD driving bias generator circuit, LCD bias voltages can be obtained by merely providing a required capacitance externally.

The MSM9000B-xx is applicable to a variety of LCD panels by controlling the contrast.

**FEATURES**

- Logic voltage( $V_{DD}$ ): 2.5 to 3.3 V
- LCD driving voltage( $V_{BI}$ ): 3.0 to 5.5 V
- Low current consumption: 35  $\mu$ A max.(operating)
- Switchable between 8-bit serial interface and 8-bit parallel interface
- Contains a 16-dot common driver and a 60-dot segment driver
- Contains CGROM with character fonts of (5 x 7 dots) x 256
- Built-in bias voltage generator circuit
- Built-in contrast adjusting circuit
- Built-in 32.768 kHz crystal oscillator circuit
- Provided with 120 dot arbitrators
- 1/9 duty mode (1 line : characters, 2 lines : arbitrators)  
1/16 duty mode (2 lines : characters, 2 lines : arbitrators)
- Character blink operation can be switched between all-character lighting-on mode and all-character lighting-off mode.
- Package:  
TCP mounting with 35 mm wide film ; Tin-plated (Product name: MSM9000B-xx AV-Z-xx)  
Chip (Product name : MSM9000B-xx)  
xx indicates code number.

**BLOCK DIAGRAM**

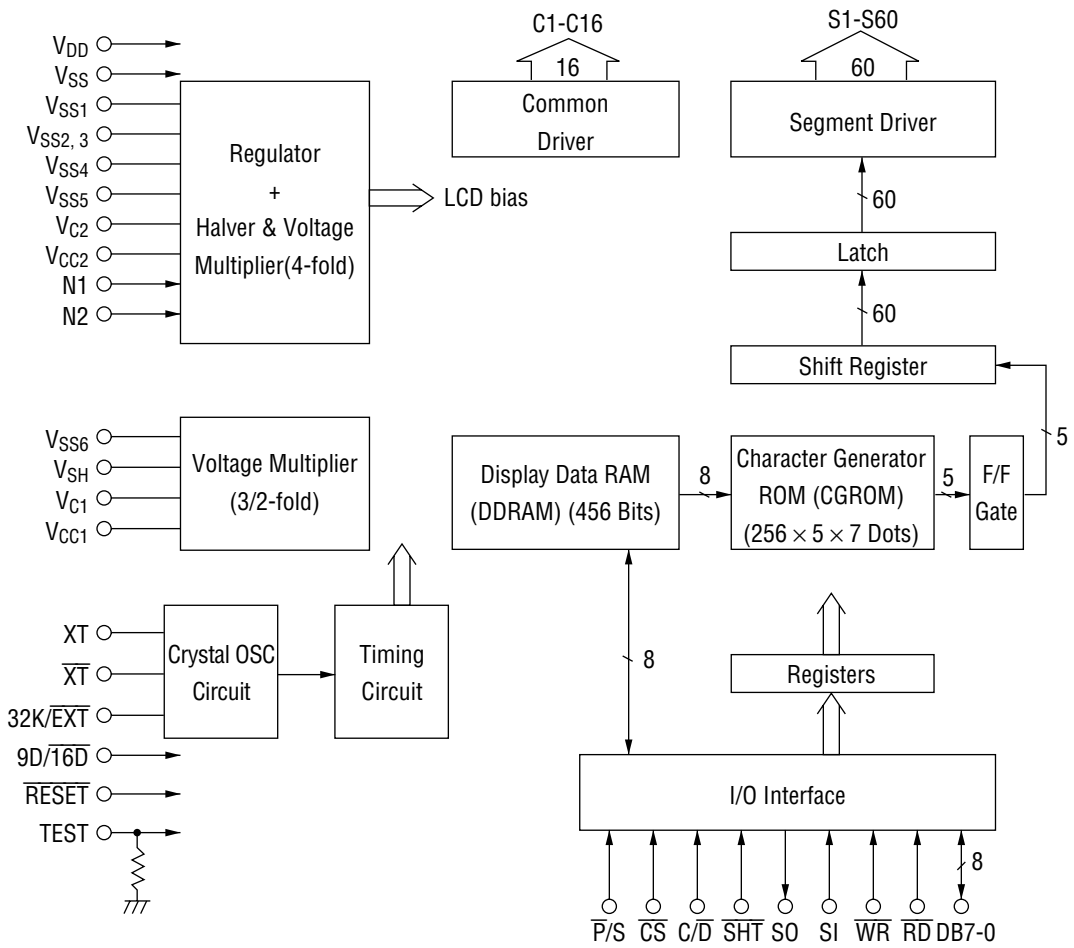

**PIN CONFIGURATION**

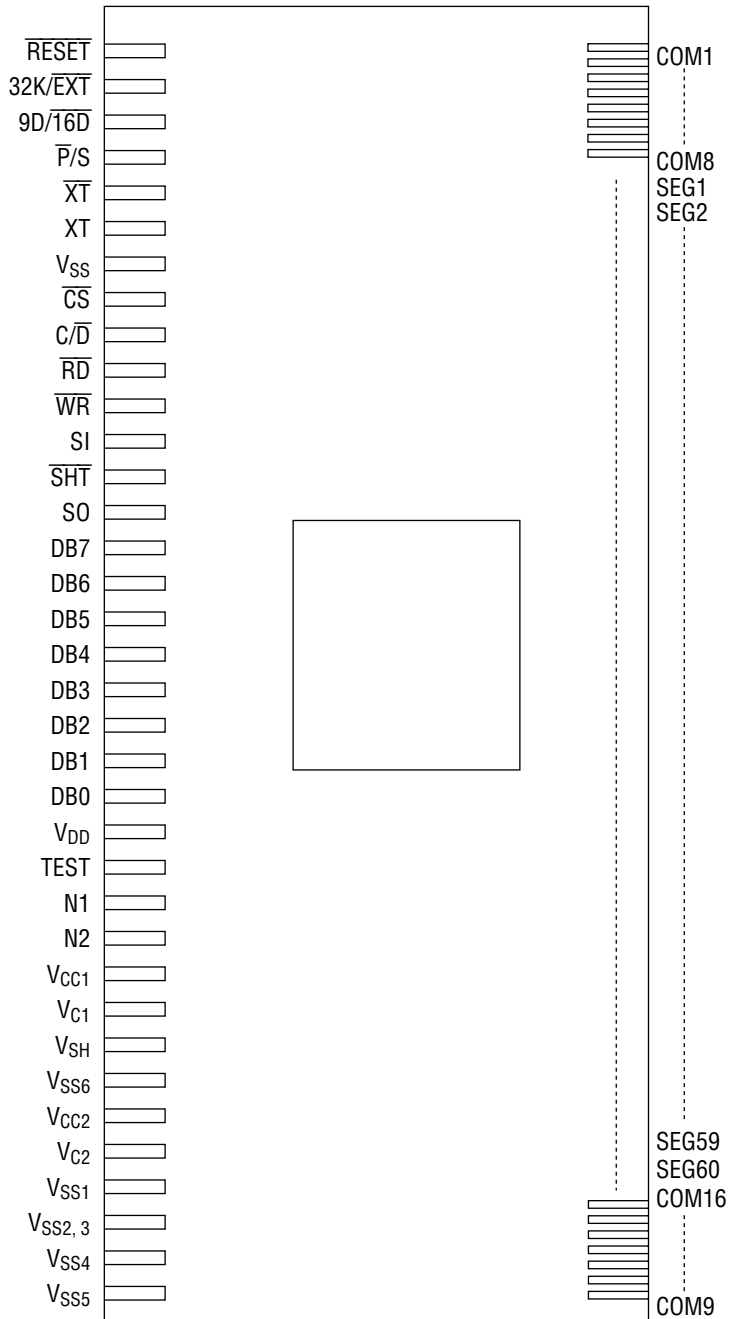

**Pin Configuration Viewed From Pattern**

**PIN DESCRIPTIONS**

Function	Symbol	Number of Pins	Type	Description
CPU Interface	$\overline{CS}$	1	I	Chip select input signal
	$\overline{WR}$	1	I	Write enable signal, latch for serial interface
	$\overline{RD}$	1	I	Read enable signal
	$C/\overline{D}$	1	I	Command/Data select input signal
	DB0-7	8	I/O	8-bit parallel data inputs/outputs
	SI	1	I	Serial data input
	SO	1	O	Serial data output
	$\overline{SHT}$	1	I	Shift clock input for data input in serial interface mode
Oscillation	XT	1	I	Crystal oscillation input, clock input
	$\overline{XT}$	1	O	Crystal oscillation output
Control Signal	$\overline{P/S}$	1	I	Parallel/Serial interface switching signal input
	$9D/\overline{16D}$	1	I	Duty select signal input
	$32K/\overline{EXT}$	1	I	Clock select signal input
	$\overline{RESET}$	1	I	Reset is performed by setting the $\overline{RESET}$ input to "L" level
	N1, N2	2	I	Contrast control signal input
	TEST	1	I	Test signal input. Fix to "L" Level or leave open
LCD Driving Output	SEG1-SEG60	60	O	Segment outputs for LCD driving
	COM1-COM16	16	O	Common outputs for LCD driving
Power Supply	$V_{DD}$	1	—	Positive + power supply pin for LOGIC
	$V_{SS}$	1	—	GND pin
	$V_{SS1}, V_{SS2}, 3$	4	—	Boosted voltage output pins & bias power supply pins
	$V_{SS4}, V_{SS5}$			
	$V_{SS6}$	1	—	Voltage multiplier output pin (3-/2-fold)
	$V_{SH}$	1	—	Haver output pin
	$V_{C1}, V_{CC1}$	2	—	Voltage multiplier (3-/2-fold)
	$V_{C2}, V_{CC2}$	2	—	Voltage multiplier (4-fold)
	Total	112		

**ABSOLUTE MAXIMUM RATINGS**

Parameter	Symbol	Condition	Rating	Unit	Applicable pin
Power supply voltage	$V_{DD}$	$T_a=25^{\circ}\text{C}$ , $V_{DD}-V_{SS}$	-0.3 to +4.6	V	$V_{DD}$ , $V_{SS}$
Bias voltage	$V_{BI}$	$T_a=25^{\circ}\text{C}$ , $V_{DD}-V_{SS5}$	-0.3 to +7	V	$V_{DD}$ , $V_{SS5}$
Input voltage	$V_I$	$T_a=25^{\circ}\text{C}$	-0.3 to $V_{DD} + 0.3$	V	All input pins
Storage temperature	$T_{STG}$	Chip	-55 to +150	°C	—
		TCP	-30 to +85		

$T_a$ : Ambient temperature

**RECOMMENDED OPERATING CONDITIONS**

Parameter	Symbol	Condition	Range	Unit	Applicable pin
Power supply voltage	$V_{DD}$	$V_{DD}-V_{SS}$	2.5 to 3.3	V	$V_{DD}$ , $V_{SS}$
Bias voltage	$V_{BI}$	*1, $V_{DD}-V_{SS5}$	3 to 5.5	V	$V_{DD}$ , $V_{SS5}$
IC source oscillation	$f_{int}$	*2	26 to 47	kHz	*3
Operating temperature	$T_{op}$	—	-30 to +85	°C	—

\*1  $V_{DD}$  is the highest pin and  $V_{SS5}$  the lowest for the bias voltage.

\*2 Connect the specified capacitors to the voltage doubler and LCD bias generator.

\*3 Make sure that the crystal oscillation frequency or the divided clock frequency falls within this range.

Note 1: Ensure the chip is not exposed to any light.

Note 2: The bias voltage may exceed 5.5 V at some contrast stages. Adjust the stage with software so that the bias voltage does not exceed 5.5 V.

## ELECTRICAL CHARACTERISTICS

## DC Characteristics (1)

(V<sub>DD</sub> = 2.5 to 3.3 V, V<sub>BI</sub> = 3 to 5.5 V, T<sub>a</sub> = -30 to +85°C)

Parameter	Symbol	Condition	Min.	Typ.	Max.	Unit	Applicable pin
Input high voltage 1	V <sub>IH1</sub>	—	V <sub>DD</sub> -0.25	—	V <sub>DD</sub>	V	XT
Input high voltage 2	V <sub>IH2</sub>	—	0.8V <sub>DD</sub>	—	V <sub>DD</sub>	V	Other inputs
Input low voltage 1	V <sub>IL1</sub>	—	0	—	0.55	V	XT
Input low voltage 2	V <sub>IL2</sub>	—	0	—	0.2V <sub>DD</sub>	V	Other input pins
Input high current 1	I <sub>IH1</sub>	V <sub>I</sub> =V <sub>DD</sub>	—	—	1	μA	Input pins other than XT and TEST
Input high current 2	I <sub>IH2</sub>	V <sub>I</sub> =V <sub>DD</sub>	10	—	60	μA	TEST (pull-down resistor)
Input low current 1	I <sub>IL1</sub>	V <sub>I</sub> =0 V	-1	—	—	μA	Input pins other than XT and TEST
Off leakage current	I <sub>off</sub>	V <sub>I</sub> =V <sub>DD</sub> /0 V	-1	—	1	μA	SO and DB0 to DB7
Output high voltage 1	V <sub>OH</sub>	I <sub>O</sub> =-500 μA	0.9V <sub>DD</sub>	—	—	V	SO and DB0 to DB7
Output low voltage 1	V <sub>OL1</sub>	I <sub>O</sub> =500 μA	—	—	0.1V <sub>DD</sub>	V	SO and DB0 to DB7
COM output resistance	R <sub>C</sub>	I <sub>O</sub> =±50 μA	—	—	10	kΩ	COM1 to COM16
SEG output resistance	R <sub>S</sub>	I <sub>O</sub> =±20 μA	—	—	30	kΩ	SEG1 to SEG60
Drain current 1	I <sub>DD1</sub>	During operation *1 Crystal oscillation f = 32.768 kHz	—	15	35	μA	V <sub>DD</sub>
Drain current 2	I <sub>DD2</sub>	During operation *1 External clock f = 32 kHz	—	15	35	μA	V <sub>DD</sub>
Drain current 3	I <sub>DD3</sub>	During standby	—	—	7	μA	V <sub>DD</sub>

\*1 No output load

Note : The values in this table are assured when the chip is not exposed to light.

**DC Characteristics (2)**

( $V_{DD}=0\text{ V}$ ,  $V_{SS}=-3\text{ V}$ ,  $T_a=-30\text{ to }+85^\circ\text{C}$ )

Parameter	Symbol	Condition	Min.	Typ.	Max.	Unit	Applicable pin
Bias voltage 1	$-V_{SS1}$	$-V_{SS2,3} = "A"V$	$1/2A-0.1$	$1/2A$	$1/2A+0.1$	V	$V_{SS1}$
Bias voltages 2 and 3	$-V_{SS2,3}$	N1 = "L", N2 = "L" Contrast = "5"	1.9	2.2	2.5	V	$V_{SS2,3}$
Bias voltage 4	$-V_{SS4}$	$-V_{SS2,3} = "A"V$	$3/2A-0.1$	$3/2A$	$3/2A+0.1$	V	$V_{SS4}$
Bias voltage 5	$-V_{SS5}$	$-V_{SS2,3} = "A"V$	$2A-0.2$	$2A$	$2A+0.2$	V	$V_{SS5}$
Contrast pitch	$-V_{con}$	$V_{BI}$ for each stage	0.18	0.21	0.26	V	—

Note 1: Connect a 0.1  $\mu\text{F}$  capacitor to the LCD bias generator.

Note 2: The values in this table are assured when the chip is not exposed to light.

**AC Characteristics**

Parallel interface

( $V_{DD}=2.5\text{ to }3.3\text{ V}$ ,  $V_{BI}=3\text{ to }5.5\text{ V}$ ,  $T_a=-30\text{ to }+85^\circ\text{C}$ )

Parameter	Symbol	Condition	Min.	Max.	Unit
$\overline{RD}$ high-level width	$t_{WRH}$	—	200	—	ns
$\overline{RD}$ low-level width	$t_{WRL}$	—	200	—	ns
$\overline{WR}$ high-level width	$t_{WWH}$	—	200	—	ns
$\overline{WR}$ low-level width	$t_{WWL}$	—	200	—	ns
$\overline{WR}$ - $\overline{RD}$ high-level width	$t_{WWRH}$	—	200	—	ns
$\overline{CS}$ or $\overline{C/D}$ setup time	$t_{AS}$	—	50	—	ns
$\overline{CS}$ or $\overline{C/D}$ hold time	$t_{AH}$	—	0	—	ns
Write data setup time	$t_{DSW}$	—	50	—	ns
Write data hold time	$t_{DHW}$	—	50	—	ns
Read data output delay time	$t_{DDR}$	$C_L=50\text{ pF}$	—	200	ns
Read data hold time	$t_{DHR}$	—	20	—	ns
External clock high-level width	$t_{WCH}$	—	1	—	$\mu\text{s}$
External clock low-level width	$t_{WCL}$	—	1	—	$\mu\text{s}$
$\overline{RESET}$ pulse width	$t_{WRE}$	—	2.0	—	$\mu\text{s}$
Rise and fall time of external clock	$t_r, t_f$	—	—	100	ns

Note: The values in this table are assured when the chip is not exposed to light.

Serial interface

( $V_{DD} = 2.5$  to  $3.3$  V,  $V_{BI} = 3$  to  $5.5$  V,  $T_a = -30$  to  $+85^\circ\text{C}$ )

Parameter	Symbol	Condition	Min.	Max.	Unit
$\overline{CS}$ or $C/\overline{D}$ setup time	$t_{SAS}$	—	100	—	ns
$\overline{CS}$ or $C/\overline{D}$ hold time	$t_{SAH}$	—	20	—	ns
SI setup time	$t_{IS}$	—	100	—	ns
SI hold time	$t_{IH}$	—	20	—	ns
$\overline{SHT}$ high-level pulse width	$t_{WSHH}$	—	100	—	ns
$\overline{SHT}$ low-level pulse width	$t_{WSHL}$	—	100	—	ns
$\overline{SHT}$ clock cycle time	$t_{SYS}$	—	400	—	ns
SO ON delay time	$t_{ON}$	$C_L = 50$ pF	—	200	ns
SO output delay time	$t_{DS}$	$C_L = 50$ pF	0	200	ns
SO OFF delay time	$t_{OFF}$	—	—	100	ns
BUSY delay time	$t_{BUSY}$	$C_L = 50$ pF	—	200	ns
$\overline{WR}$ setup time	$t_{SHS}$	—	200	—	ns
$\overline{WR}$ low-level pulse width	$t_{WWL}$	—	120	—	ns
$\overline{RESET}$ pulse width	$t_{WRE}$	—	2.0	—	$\mu\text{s}$
Rise and fall time of external clock	$t_r, t_f$	—	—	100	ns

Note: The values in this table are assured when the chip is not exposed to light.





Timing Diagram for the Serial Interface

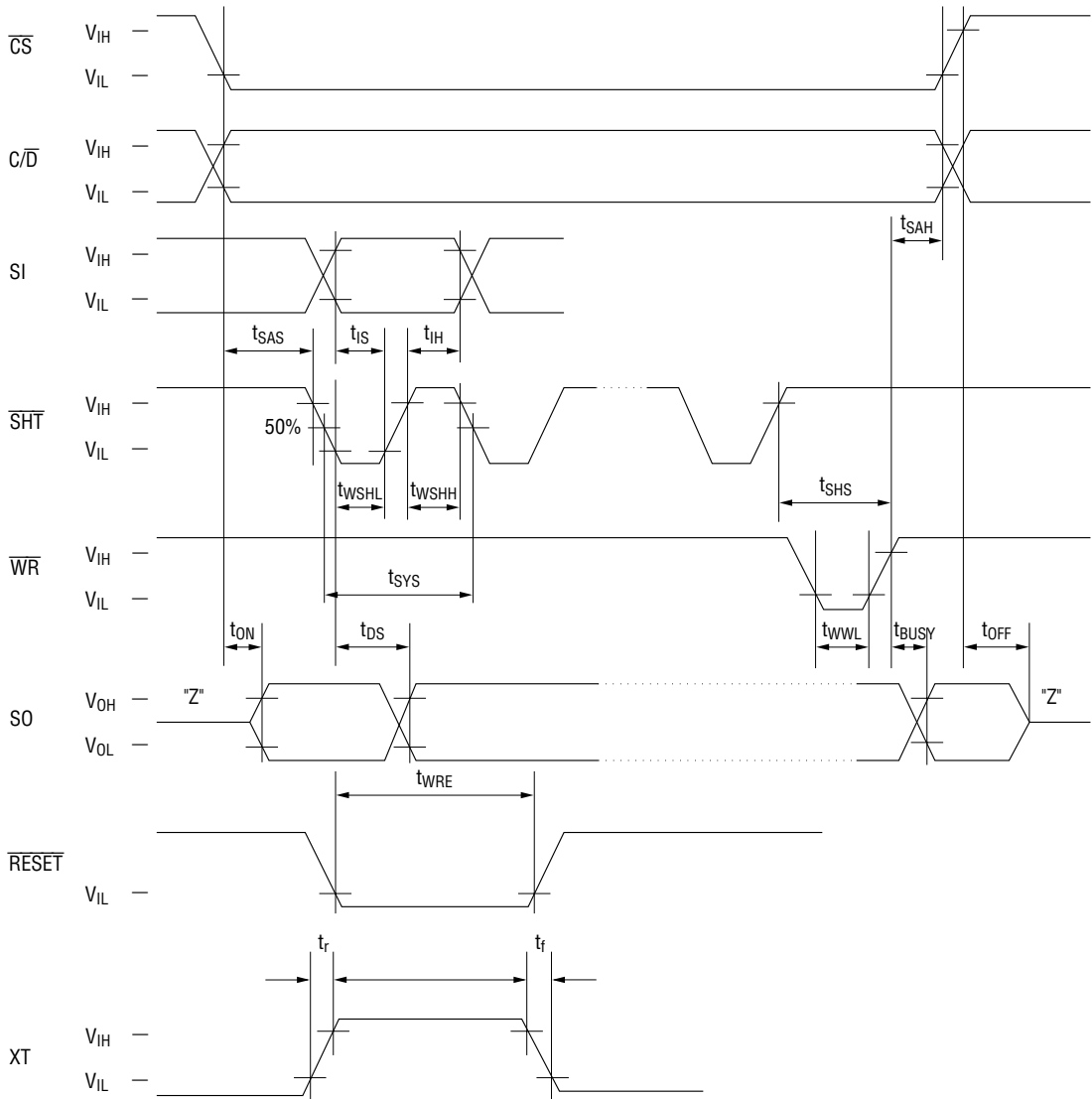

$V_{IH} = 0.8 V_{DD}$ ,     $V_{IL} = 0.2 V_{DD}$   
 $V_{OH} = 0.9 V_{DD}$ ,     $V_{OL} = 0.1 V_{DD}$

## FUNCTIONAL DESCRIPTION

### Pin Functional Description

- $\overline{\text{CS}}$  (Chip Select)  
Chip select input pin. A logic low on the  $\overline{\text{CS}}$  input selects the chip and a logic high on the CS input does not select the chip. Command and display data inputs can be enabled only when the chip is selected.  
When the input is high, the SO pin and DB0 to DB7 pins are in the high impedance state, causing  $\overline{\text{SHT}}$ ,  $\overline{\text{WR}}$  and  $\overline{\text{RD}}$  pins high level internally.
- $\overline{\text{WR}}$  (Write Enable)  
When the parallel interface is used, this pin is the write signal input. Data is written into the register at the rising edge of  $\overline{\text{WR}}$  pulse. When the serial interface is used, this pin is the latch signal input. This pin is normally high.
- $\overline{\text{RD}}$  (Read Enable)  
When the parallel interface is used, this pin is the read signal input. While the pulse is low, data can be read. The pin is normally high. When this pin is made low with  $\text{C}/\overline{\text{D}}$  set low, the display data pointed to by the address pointer is output from DB0 to DB7. When the pin is made low with  $\text{C}/\overline{\text{D}}$  set high, busy data is output from DB0 and low signals are output from DB1 to DB7. After the rising edge of  $\overline{\text{WR}}$ , busy data (H) is output. The data automatically changes to non-busy (L) after the specified time elapses.  
When the serial interface is used, fix this pin to "H" or "L".
- $\text{C}/\overline{\text{D}}$  (Command/Data Select)  
This input pin selects whether the data to be input to the SI pin and the DB7 to DB0 pins is handled as a command or display data, depending on the state of the pin at the rising edge of  $\overline{\text{WR}}$ . When the pin is H, the input data is handled as a command. When the pin is L, display data is input.
- DB0 to DB7 (Data Buses 0 to 7)  
Data input and output pins for the parallel interface. Normally data buses 0 to 7 are in high impedance, when  $\overline{\text{RD}}$  is driven low, display data and the busy signal are output.  
When the serial interface is used, leave this pin open.
- SI (Serial Data Input)  
Data input pin for the serial interface. Commands and display data are read at the rising edge of  $\overline{\text{SHT}}$  and written to registers at the rising edge of  $\overline{\text{WR}}$ . The eight-bit data immediately before the rising edge of  $\overline{\text{WR}}$  is valid.  
When the parallel interface is used, fix this pin to "H" or "L".
- SO (Serial Data Output)  
Data output pin for the serial interface. The display data pointed to by the address pointer is output at the rising edge of  $\overline{\text{SHT}}$ . After the rising edge of  $\overline{\text{WR}}$ , busy data (H) is output. The data automatically changes to non-busy (L) after the specified time elapses.  
When the parallel interface is used, this pin remains in the high impedance state.
- $\overline{\text{SHT}}$  (Shift Clock)  
Clock input pin to input and output serial interface data. Data input is synchronous with the rising edge of the clock, and the data output is synchronous with the falling edge of the clock. This pin is normally high.  
When the parallel interface is used, fix this pin to "H" or "L".

- XT (Crystal)

Input pin for crystal oscillation. By connecting a 32.768-kHz crystal and capacitors to this pin and the XT pin, a crystal oscillation circuit is formed. When an external clock is used, input the clock to the XT pin.

- $\overline{XT}$  (Crystal)

Output pin for crystal oscillation. By connecting a 32.768-kHz crystal and capacitors to this pin and the XT pin, a crystal oscillation circuit is formed. When the external clock is used, leave this pin open.

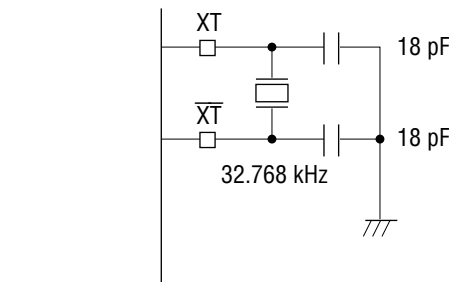

When forming a crystal oscillation circuit

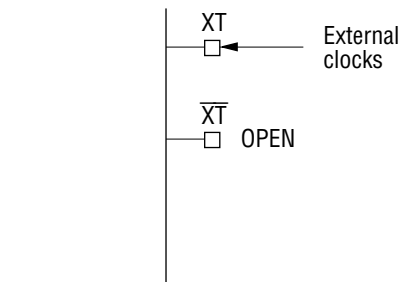

When inputting an external clock

### Oscillation circuit diagram

- $\overline{P/S}$  (Parallel/Serial Select)

Input pin to choose between the parallel interface and serial interface. To select the parallel interface, make this pin low. To select the serial interface, make this pin high. After power is turned on, do not change the setting of this pin.

- $9D/\overline{16D}$  (Duty Select)

Input pin to set a duty cycle. When this pin is set to "H", a duty cycle of 1/9 is selected. When the pin is set to "L", a duty cycle of 1/16 is selected. Choose either according to the panel to be used. When a duty cycle of 1/9 is chosen, leave common output pins COM10 to COM16 open.

- $32K/\overline{EXT}$  (Clock Select)

Input pin to choose crystal oscillation mode or external clock input mode. Leave this pin at a "L" level.

- $\overline{RESET}$  (Reset)

Reset signal input pin. Setting this pin to L results in the initial state. For modes and the display after a reset input, see "Mode Settings after a Reset Input".

- N1, N2 (Contrast Change)

Input pins that determine the voltages of  $V_{SS2}$  and  $V_{SS3}$  together with contrast adjustment by a command. The table below shows the relationships between pin states and contrast adjustment ranges.

N1	N2	Contrast adjustment range by command
L	L	0 to 7
L	H	1 to 8
H	L	2 to 9
H	H	3 to A

- TEST (Test Signal)  
Test signal input pin provided for test by the manufacturer. Fix this pin to L or leave it open.
- SEG1 to SEG60 (Segment 1 to Segment 60)  
Segment signal output pins to drive the LCD. Leave the unused pins open.
- COM1 to COM16 (Common 1 to Common 16)  
Common signal output pins to drive the LCD. When the duty cycle is 1/9, use COM1 to COM9 and leave COM10 to COM16 open.
- V<sub>DD</sub>  
Power supply pin to the logic section. Connect this pin to the positive terminal on the power supply.
- V<sub>SS</sub>  
Pin to be connected to the GND power supply.
- V<sub>SS1</sub>, V<sub>SS4</sub>, V<sub>SS5</sub>  
Pins for voltage multiplier outputs and LCD power supply. Connect capacitors of 0.1 μF between these pins and V<sub>DD</sub> for the charge distribution with V<sub>SS2,3</sub> capacitor and for voltage stabilization during generation of LCD bias voltages. The logical values of the LCD bias voltage are as follows:

$$\begin{aligned}
 &\text{Highest voltage: } V_{DD} \\
 &\quad V_{SS1} = V_{SS2,3} / 2 \\
 &\quad V_{SS2,3} \\
 &\quad V_{SS4} = V_{SS2,3} + V_{SS2,3} / 2 \\
 &\text{Lowest voltage: } V_{SS5} = V_{SS2,3} + V_{SS2,3} / 2 + V_{SS2,3} / 2
 \end{aligned}$$

For both the 1/9 and 1/16 duty, 1/4 bias is used.

- V<sub>SS2,3</sub>  
Voltage regulator output pin & LCD bias generator input used as a reference voltage for the LCD bias generator.  
Connect a capacitor of 0.1 μF between this pin and V<sub>DD</sub> for charge distribution among capacitors and voltage stabilization during generation of various LCD bias voltages.
- V<sub>SS6</sub>  
Pin to connect the capacitor to store the 3-/2-fold voltage. Connect a capacitor of 0.1μF or more between this pin and V<sub>DD</sub>.
- V<sub>SH</sub>  
Halves output pin for the voltage multiplier(3-/2-fold). Connect a 0.1 μF capacitor between this pin and V<sub>DD</sub>.

- $V_{C1}$ ,  $V_{CC1}$   
Pins to connect the charge distribution capacitor used for the voltage multiplier (3-/2-fold).  
Connect a 0.1  $\mu\text{F}$  capacitor between  $V_{C1}$  and  $V_{CC1}$ .
- $V_{C2}$ ,  $V_{CC2}$   
Pins to connect the capacitor for charge distribution to generate LCD bias voltages on the basis of  $V_{SS2, 3}$ . Connect a 0.1  $\mu\text{F}$  capacitor between  $V_{C2}$  and  $V_{CC2}$ .

**Parallel Interface Input-Output Timing**

Input timing diagram

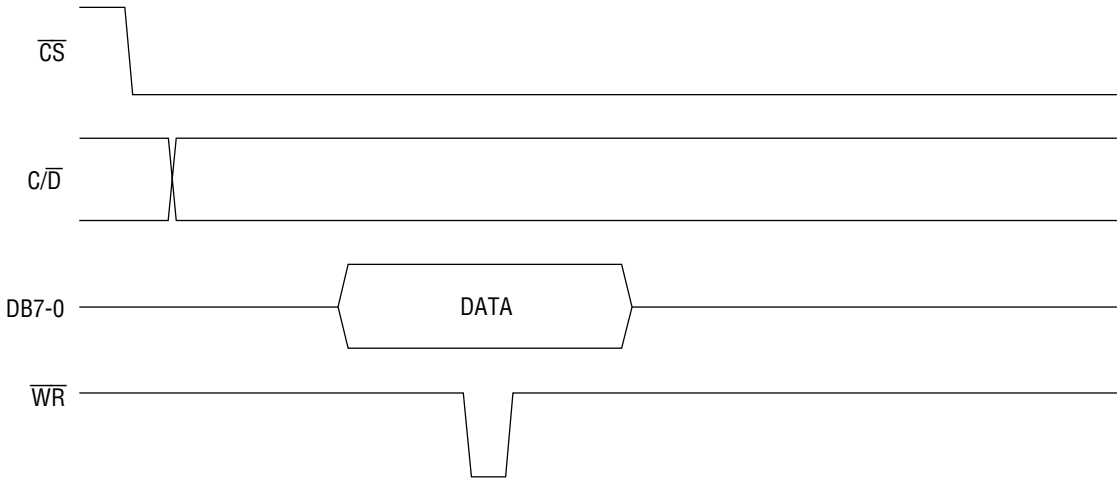

Output timing diagram

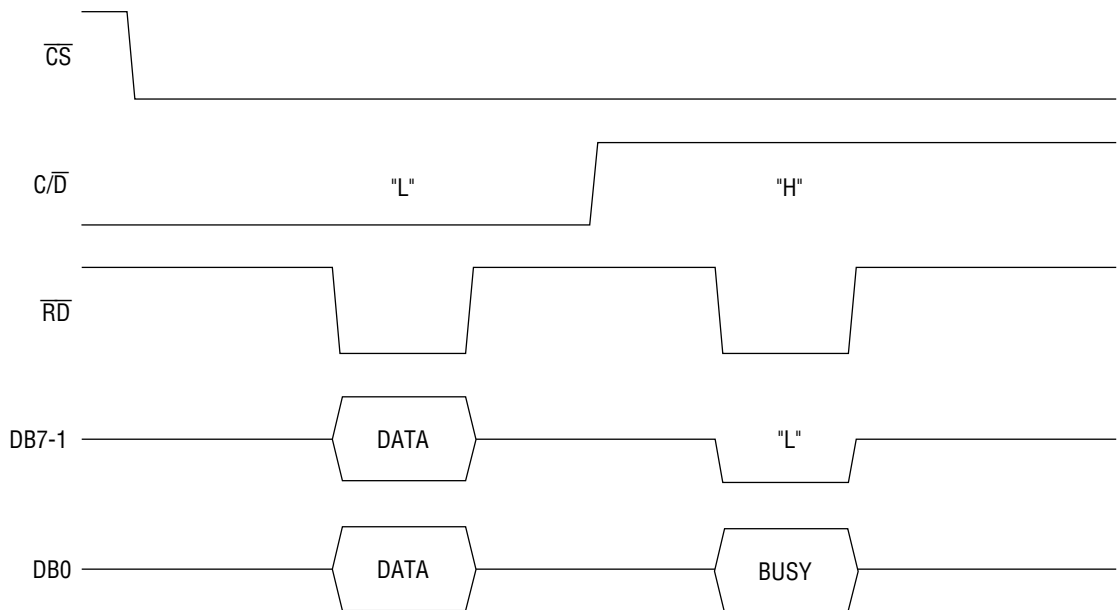

When  $C/\overline{D}$ ="L", RAM display data is output on DB7-0 pins.  
 When  $C/\overline{D}$ ="H" and  $DB7-1$ ="L", busy data is output on DB0 pin.

**I/O Timings on the Serial Interface**

Input timing diagram

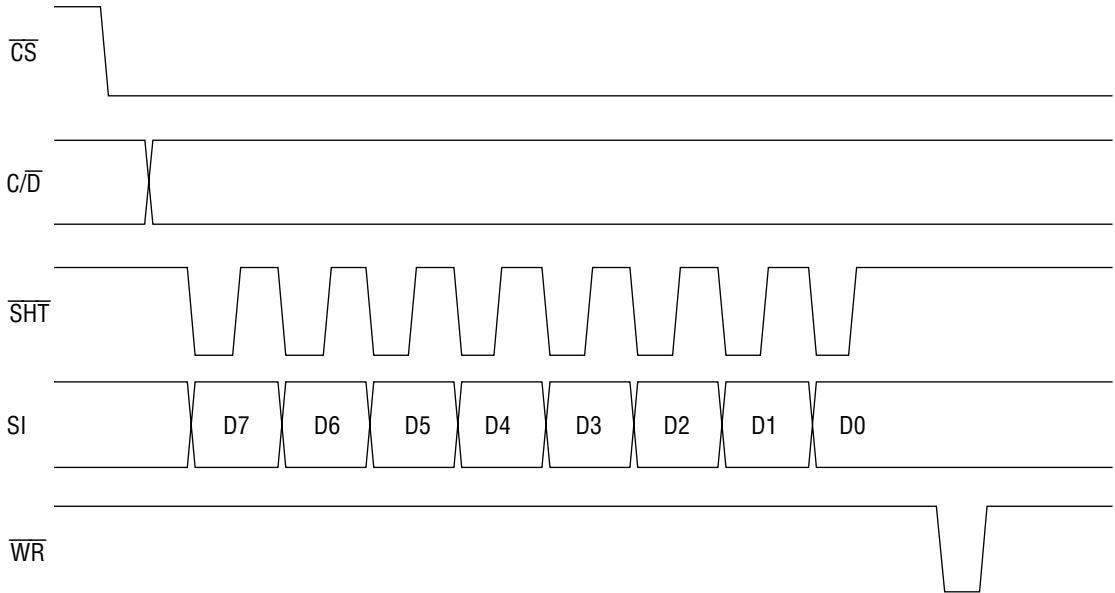

Output timing diagram

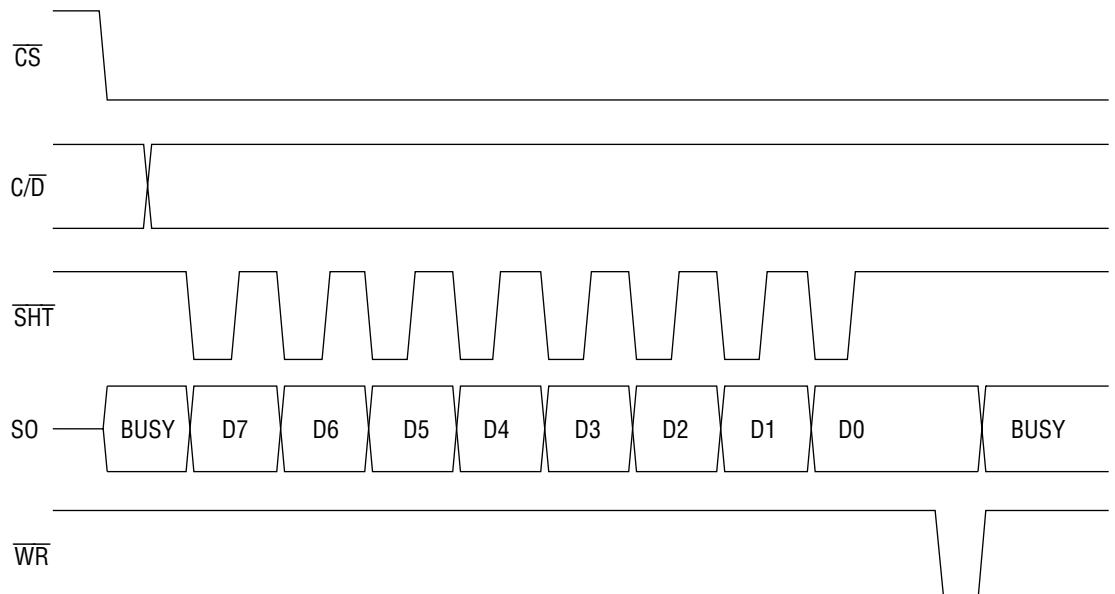

In  $SO$  output, the eight bits after the  $\overline{WR}$  pulse is input are valid.



**LIST OF COMMANDS**

\*: Don't Care

No	Mnemonics	Operation	D								Comments
			7	6	5	4	3	2	1	0	
1	LPA	Load Pointer Address	1	1	A5	A4	A3	A2	A1	A0	Addresses 0-11, 16-27 for characters and addresses 32-43, 48-59 for arbitrators
2	LOT	Load Option	1	0	1	1	*	*	I1	I0	Sets additional functions during execution of AINC.
3	SF	Set Frequency	1	0	1	0	*	*	F1	F0	Sets conditions on master frequency.
4	BKCG 1/0	Bank Change 1/0	1	0	0	*	0	0	0	1/0	Valid only in 1/9 duty. Changes display addresses 0-11, 16-27.
5	CONT U/D	Contrast Up/Down	1	0	0	*	0	0	1	1/0	Adjusts VLCD to 8 stages. Adjustment range is changed by setting N1 and N2 pins. Contrast level is up if D0="1". Contrast level is down if D0="0".
6	STOP	Set Stop Mode	1	0	0	*	0	1	0	0	This mode is cancelled if D0="1" irrespective of either "H" or "L" on C/D. Stops oscillation and performs operation equivalent to that of the DISP OFF command.
7	SOE/D	Serial Out Enable/Disable	1	0	0	*	0	1	1	1/0	Switches between output and high impedance of SO.
8	DISP	Display On/Off	1	0	0	1/0	1	0	0	1/0	Display is ON if D0="1". Display is OFF if D0=0. All commons and segments are at V <sub>DD</sub> level if display is OFF. Arbitrators alone are displayed if D4="1".
9	AINC	Address Increment	1	0	0	*	1	0	1	*	Pointer address is incremented by 1. But, this command is invalid to operations that are added by setting (I1, I0).
10	ABB	Arbitrator Blink	1	0	0	*	1	1	0	1/0	Data that is input after setting D0="1", is set as data for arbitrator blink (1-dot unit). This is cancelled by D0="0".
11	CHB	Character Blink	0	0	0	*	0	0	1/0	*	Controls blinking of character.
12	BPC	Blink Pattern Control	1	0	0	*	1	1	1	1/0	Sets blink patterns of characters. (□ : chara) if D0="1", (■ : chara) if D0="0".
13	ABLC	Arbitrator Line Change	0	1	1	*	*	*	L1	L0	Sets arbitrator display lines.

Notes :1 Pointer address is not changed even if commands numbers 1 to 8, 10, 12, 13 are entered.  
:2 Pointer address is automatically incremented by 1 when commands numbers 9, 11, display code data, and arbitrator data are entered.

• **LOT**

I1	I0	Additional function	Remarks
0	0	No additional function	
0	1	A blank code is written for each subsequent AINC.	Used to automatically clear RAM at power-on.
1	0	Blinking is canceled for each subsequent AINC.	
1	1	The above two functions are ORed.	

• **SF**

F1	F0	Frequency of source oscillation in the IC	Remarks
0	0	XT	Used to generate the optimum frequency when external clocks are input.
0	1	XT ÷ 2	
1	0	XT ÷ 4	
1	1	XT ÷ 8	

• **DISP**

D4	D0	Character	Arbitrator	Remarks
*	0	OFF	OFF	Used to turn on and off the display.
0	1	ON	ON	
1	1	OFF	ON	

\* : Don't care

• **ABLC (when the duty is 1/16)**

L1	L0	Arbitrator 1	Arbitrator 2	Remarks
0	0	COM1	COM2	Arbitrator 1 indicates display data at addresses 32 to 43, while arbitrator 2 indicates display data at addresses 48 to 59.
0	1	COM15	COM16	
1	*	COM16	COM1	

\* : Don't care

• **ABLC (when the duty is 1/9)**

L1	L0	Arbitrator 1	Arbitrator 2	Remarks
0	0	COM1	COM2	Arbitrator 1 indicates display data at addresses 32 to 43, while arbitrator 2 indicates display data at addresses 48 to 59.
0	1	COM8	COM9	
1	*	COM9	COM1	

\* : Don't care

**Explanation of Commands**

[D7, D6, D5, D4, D3, D2, D1, D0], X = Don't care

- LPA (Load Pointer Address)

[1, 1, A5, A4, A3, A2, A1, A0]

This command sets in the address pointer the address of the command to be executed or the address of the display data to be input. The settable addresses are inconsecutive addresses 00H to 0BH, 10H to 1BH, 20H to 2BH, 30H to 3BH represented by A5 to A0. When addresses 0CH to 0FH, 1CH to 1FH, 2CH to 2FH, or 3CH to 3FH are set, 00H is assumed.

After  $\overline{\text{RESET}} = "L"$ , the address is set to 00H.

- LOT (Load Option)

[1, 0, 1, 1, X, X, I1, I0]

This command executes the additional function specified by I1 and I0 to the display of the current address when the AINC command is executed. Additional functions are shown below.

After  $\overline{\text{RESET}} = "L"$ , both I1 and I0 are set to "0".

I1	I0	Additional function
0	0	None
0	1	After this command is executed, the blank code is writtern each time AINC is executed.
1	0	After this command is executed, blinking is canceled each time AINC is executed.
1	1	The above two additional functions are ORed.

- SF (Set Frequency)

[1, 0, 1, 0, X, X, F1, F0]

This command sets the number by which the external clock input from the XT pin is divided in order to get the source frequency inside the IC. This command is valid when  $32K/\overline{\text{EXT}}$  pin is "L". The dividing ratio is specified by F1 and F0 in the command. The table below lists the source oscillation frequencies in the IC.

After  $\overline{\text{RESET}} = "L"$ , both F1 and F0 are set to "0".

F1	F0	Frequency of source oscillation in the IC
0	0	XT
0	1	XT ÷ 2
1	0	XT ÷ 4
1	1	XT ÷ 8

- BKCG1/0 (Bank Change 1/0)

[1, 0, 0, X, 0, 0, 0, 1/0]

This command changes addresses (banks) to be displayed. The command is valid only when the duty is 1/9. When D0 is 0, addresses 0 to 11 (character 1), 32 to 43, and 48 to 59 (arbitrators 1 and 2) are displayed. When D0 is "1", addresses 16 to 27 (character 2), 32 to 43, and 48 to 59 (arbitrators 1 and 2) are displayed. The command and display data can be set regardless of the bank setting.

After  $\overline{\text{RESET}} = "L"$ , D1 is set to "0".

- CONT U/D (Contrast Up Down)

[1, 0, 0, X, 0, 0, 1, 1/0]

This command selects the voltage of  $V_{SS2,3}$  that is used as the reference voltage for the LCD bias. When the value of  $V_{SS2,3}$  is changed, the contrast is changed accordingly.

The contrast is controlled by the value of the 3-bit up/down counter so that eight stages are supported. The value of the up/down counter is incremented when "1" is entered by this command and decremented when "0" is entered. The counter changes within the range of 0 to 7.

When the counter reaches 7, it goes back to "0".

According to the settings of N1 and N2, the contrast stages can be changed to 1 to 8, 2 to 9, or 3 to A.

At stage 0, the bias voltage is minimized. The larger the contrast stage, the higher the bias voltage. At stage A, the bias voltage is maximized.

After a low  $\overline{\text{RESET}}$  is input, the counter is set to the minimum value specified by N1 and N2.

Example:  $\dots 6 \leftrightarrow 7 \leftrightarrow 0 \leftrightarrow 1 \leftrightarrow 2 \leftrightarrow 3 \leftrightarrow 4 \leftrightarrow 5 \leftrightarrow 6 \leftrightarrow 7 \leftrightarrow 0 \dots$

Note: At some contrast stages, the bias voltage may be increased to 5.5 V or higher. Adjust the stage so that the bias voltage does not exceed 5.5 V.

- STOP (Set Stop Mode)

[1, 0, 0, X, 0, 0, 1, 0]

This command sets standby mode. Specifically, the command stops the oscillation block to prevent current from flowing through the oscillation block and outputs the  $V_{DD}$  level to all LCD output pins. Standby mode is canceled when D0 is set to "1" regardless of the setting of the  $C/\overline{D}$  pin. When a command or data with D0 set to "1" is entered, the command is executed or the data is input. At the same time, standby mode is canceled.

After  $\overline{\text{RESET}} = "L"$ , standby mode is disabled.

- SOE/D (Serial Out Enable/Disable)

[1, 0, 0, X, 0, 1, 1, 1/0]

This command controls the impedance of the SO output pin. The command is valid only when the serial interface is used. When D0 is set to "0", the SO pin is set in the high impedance state. After  $\overline{\text{RESET}} = "L"$ , D0 is set to "0".

- DISP (Display On/Off)

[1, 0, 0, 1/0, 1, 0, 0, 1/0]

This command sets LCD display mode. When D0 is set to "1", the LCD is turned on. When D0 is set to "0", the LCD is turned off, in which case, the  $V_{DD}$  level is output to all segment and common pins. When the LCD is turned ON (D0="1"), and D4 is set to "1", only arbitrators are displayed and when D4 is set to "0", both characters and arbitrators are displayed. The table below lists display modes.

After  $\overline{\text{RESET}} = "L"$ , both D4 and D0 are set to "0".

D4	D0	Characters	Arbitrators
X	0	OFF	OFF
0	1	ON	ON
1	1	OFF	ON

- AINC (Address Increment)

[1, 0, 0, X, 1, 0, 1, X]

This command increments the value of the address pointer by one. Each time this command is input, the value is incremented by one. Addresses are increased as follows: 00 to 11 → 16 to 27 → 32 to 43 → 48 to 59 → 00 ... This cycle is repeated. The function specified by the LOT command is performed for the previous address before the address incremented by one every time this command is input.

- ABB (Arbitrator Blink)

[1, 0, 0, X, 1, 1, 0, 1/0]

This command turns arbitrator blinking on or off. Display data input after D0 is set to "1" is handled as arbitrator blink data. Input blink data corresponds to dots of the arbitrator at the same address on a one-to-one basis. When the dot is "1", blinking is enabled. When the dot is "0", blinking is disabled. While the dot is blinking, it is turned on and off repeatedly. Blinking can be specified for a dot for which enabling the arbitrator is not specified, but the dot does not blink.

Dummy data must be set for arbitrator data D5 to D7. Data cannot be written to addresses 00 to 31 and 44 to 47.

After  $\overline{\text{RESET}}$  = "L", D0 is set to "0".

- CHB (Character Blink)

[0, 0, 0, X, 0, 1, 1/0, X]

This command enables or disables character blinking. The command is executed for the address pointed to by the address pointer. When D1 is set to "1", blinking is enabled. When D1 is set to "0", blinking is disabled. During blinking, the turning on of all dots (5×7 dots) and character display are repeated. In another blinking pattern, the turning off of all dots and character display are repeated. Either pattern is selected by the BPC command.

After  $\overline{\text{RESET}}$  = "L", the value of the address pointer is automatically incremented by one.

- BPC (Blink Pattern Control)

[1, 0, 0, X, 1, 1, 1, 1/0]

This command selects a character blinking pattern. When D0 is set to "1", the turning on of all dots (5×7 dots) and character display are repeated. When D0 is set to "0", the turning off of all dots and character display are repeated.

When D0 is "1" but the character is a blank, the character does not blink visibly. When D0 is "0", the character does not blink visibly while all its dots are turned on.

After  $\overline{\text{RESET}}$  = "L", D0 is set to "0".



- ABLC (Arbitrator Line Change)  
[0, 1, 1, X, X, X, L1, L0]

This command selects a common line for arbitrator display, according to the settings of L1 and L0. The table below shows the relationships between L1 and L0 and displayed common lines, assuming that the display data at addresses 00 to 11 is character 1, the display data at addresses 16 to 27 is character 2, the display data at addresses 32 to 43 is arbitrator 1, and the display data at addresses 48 to 59 is arbitrator 2. Different common lines are displayed for 1/16 duty and 1/9 duty.

After a low  $\overline{\text{RESET}}$  is input, both L1 and L0 are set to "0".

Common lines displayed by the ABLC command are as follows:

When 1/16 duty is chosen

L1	L0	Character 1	Character 2	Arbitrator 1	Arbitrator 2
0	0	COM3 to 9	COM10 to 16	COM1	COM2
0	1	COM1 to 7	COM8 to 14	COM15	COM16
1	X	COM2 to 8	COM9 to 15	COM16	COM1

When 1/9 duty is chosen

L1	L0	Character 1	Character 2	Arbitrator 1	Arbitrator 2
0	0	COM3 to 9		COM1	COM2
0	1	COM1 to 7		COM8	COM9
1	X	COM2 to 8		COM9	COM1

Note: When 1/9 duty is chosen, characters 1 and 2 can be switched by changing the bank.

- Increment of the address pointer by one  
When display data or arbitrator blink data is input or the AINC or CHB command is executed, the address pointer is incremented by one.

### Mode Setting after a Reset Input

The table below lists the settings of individual modes during a  $\overline{\text{RESET}} = \text{L}$  input.

Command	Mode setting	Remarks
LPA	A5 to A0 = "0"	The address pointer is set to "00".
LOT	I1 = "0", I0 = "0"	Load Option command with no additional function.
SF	F1 = "0", F0 = "0"	The dividing ratio is set to 1.
BKCG 1/0	D0 = "0"	Display addresses 00 to 11 are set.
CONT U/D	—	The control counter is set to 0 (Stage 0).
STOP	—	Standby mode is disabled.
SOE/D	D0 = "0"	The SO pin is set to the high impedance state.
DISP	D4 = "0", D0 = "0"	Both characters and arbitators display mode is set, but the display is turned off.
ABB	D0 = "0"	Display data input mode is enabled.
BPC	D0 = "0"	Blink mode is such that the turning on of all dots and character display are repeated.
ABLC	L1 = "0", L0 = "0"	Arbitrator 1 corresponds to COM1, and arbitrator 2 corresponds to COM2.

- Even when a reset is input, display RAM is not initialized. To clear the display data, a blank code must be written. (This can be done with an additional function of the AINC command.)

### Mode Settings during Standby

The table below lists the settings of individual modes during standby.

Command	Mode setting	Remarks
LPA	A5 to A0 = "0"	The address pointer is set to "00".
LOT	No change	The setting before standby mode is retained.
SF		
BKCG 1/0		
CONT U/D	—	The count before standby mode is retained.
STOP	—	Standby state 10. No change.
SOE/D	D0 = "0"	The setting before standby mode is retained.
DISP	D4 = "0", D0 = "0"	Both character and arbitrator display mode is set, but the display is turned off.
ABB	No change	The setting before standby mode is retained.
BPC		
ABLC		

- Data before standby mode is retained in display RAM.

Display Screen and Memory Addresses

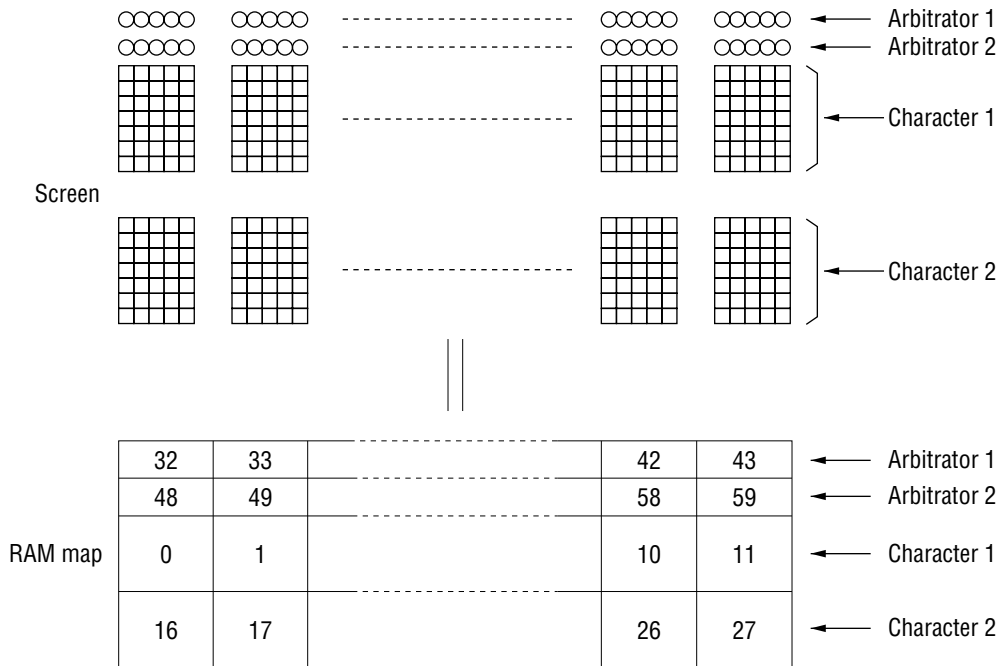

Note: Characters are input as codes. Arbitrators are displayed directly without intervening CG ROM. Input data is displayed as shown below.

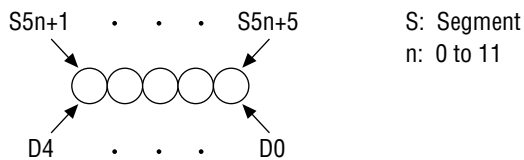

Dummy data must be set for input data D7 to D5. Either "1" or "0" can be input as input data of D7 to D5.



## Calculation Method of Various Kinds of Frequencies

- Frame frequency

For 1/16 duty

(Source clock cycle)  $\times$  (1/Dividing ratio)  $\times$  448 = Frame cycle  $\dots\dots$  (1)

For 1/9 duty

(Source clock cycle)  $\times$  (1/Dividing ratio)  $\times$  468 = Frame cycle  $\dots\dots$  (2)

Example

Source oscillation frequency = 32.768 kHz

Dividing ratio = 1/1

Specification: 1/16 Duty

Clock cycle  $T_s$  = 30.5  $\mu$ s

Under these conditions, the frame frequency can be calculated from expression (1) as follows:

Frame cycle  $T_f$  =  $30.5 \times 10^{-6} \times 1 \times 448 = 13.66$  ms

Therefore

Frame frequency = 73.2 Hz

- Calculating the blinking frequency

The blinking frequency can be calculated from the following expression:

Blinking frequency = (Source clock cycle)  $\times$  (1/Dividing ratio)  $\times 2^{15} \dots\dots$  (3)

Example

Source oscillation frequency = 32.768 kHz

Dividing ratio = 1/1

Clock cycle  $T_s$  = 30.5  $\mu$ s

Under these conditions, the blinking frequency can be calculated from expression (3) as follows:

Blinking cycle  $T_f$  =  $30.5 \times 10^{-6} \times 1 \times 2^{15} = 1$  s

Therefore

Blinking frequency = 1 Hz

- Source oscillation frequency and busy time

When data is written to or read from RAM or a command is input, data processing time (busy time) is taken. The maximum busy time is the source clock cycle multiplied by 10. The busy signal (not-busy = "L", busy = "H") is detected at the SO pin when the serial interface is used or at the DB0 pin when the parallel interface is used. When display data or commands are input consecutively, a wait must be inserted for the source clock cycle multiplied by 10. Another way is to detect busy signals and input data or commands during not-busy time only.

**Flowchart at Power-on (parallel interface)**

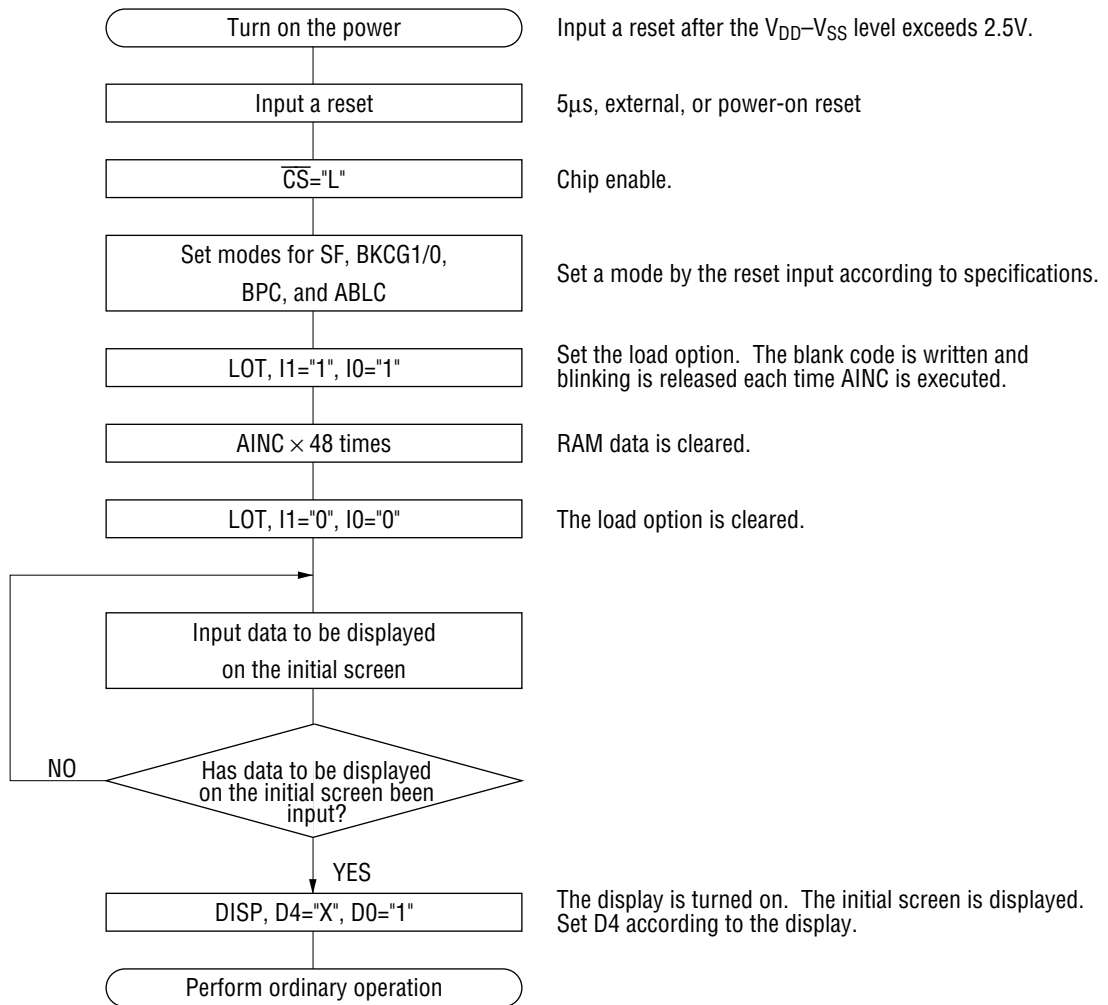

- When the stage to be selected is already determined, contrast can be adjusted before the display is turned on (for example, at the same time as when mode is set).
- After a command or display data is input, check for busy data. Make sure that the busy data ("H") has changed to not-busy data ("L") before making the next input.

**Flowchart at Power-on (serial interface)**

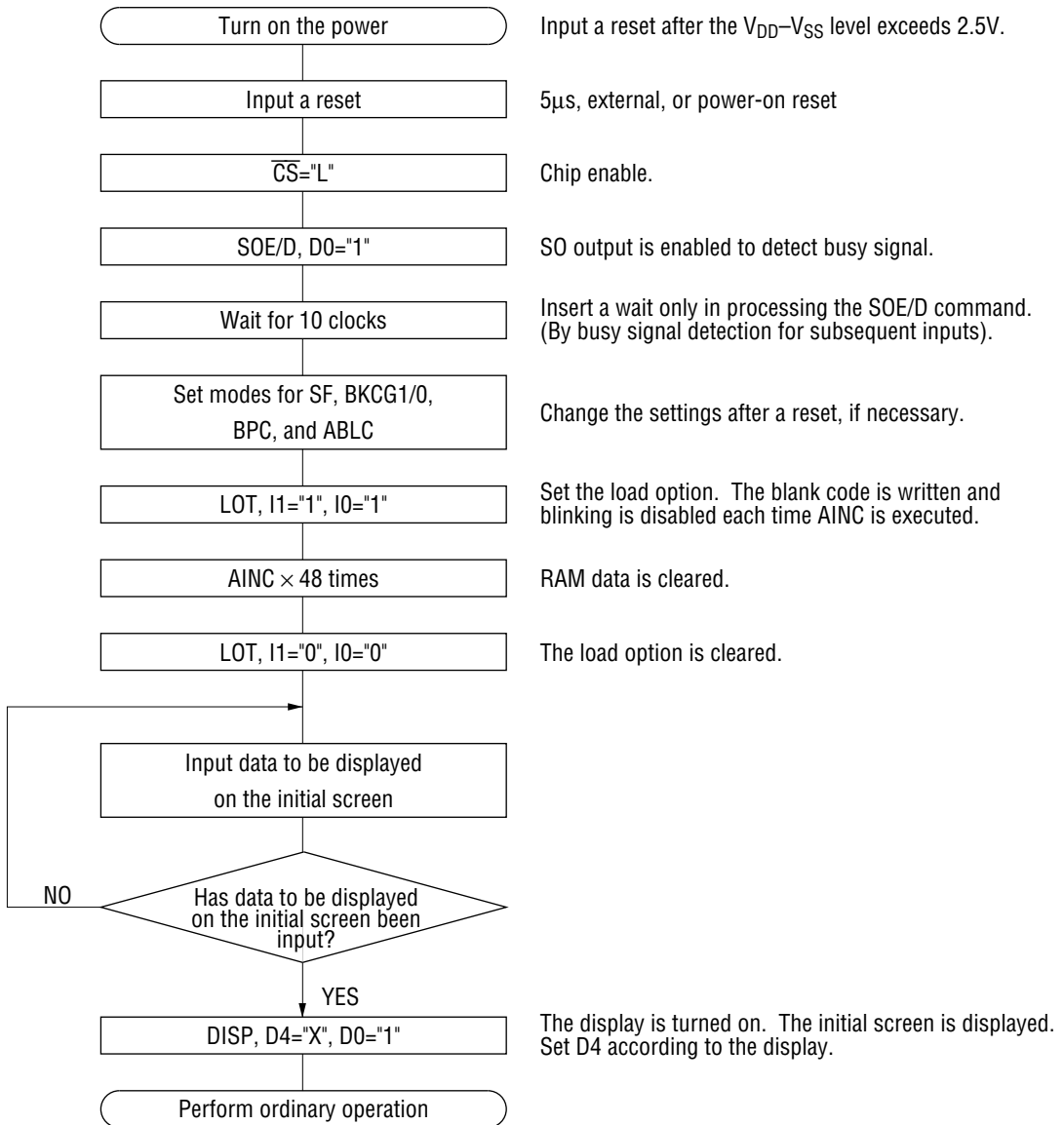

- When the stage to be selected is already determined, contrast can be adjusted before the display is turned on (for example, at the same time as when mode is set).
- After a command or display data is input, check for busy data. Make sure that the busy data ("H") has changed to not-busy data ("L") before making the next input.

### Flowcharts to Set and Cancel Standby Mode

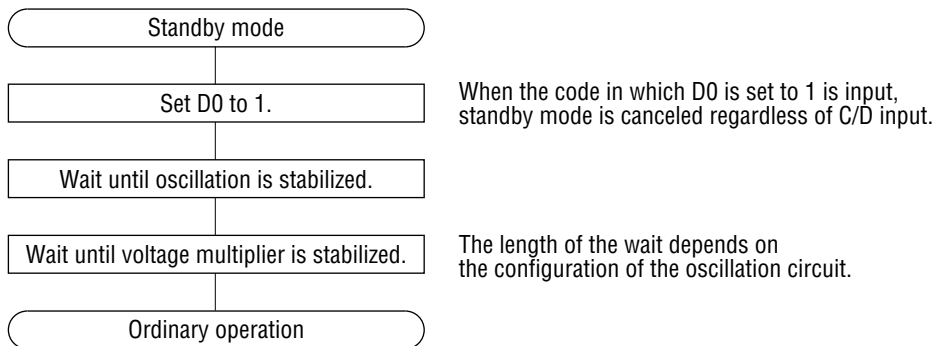
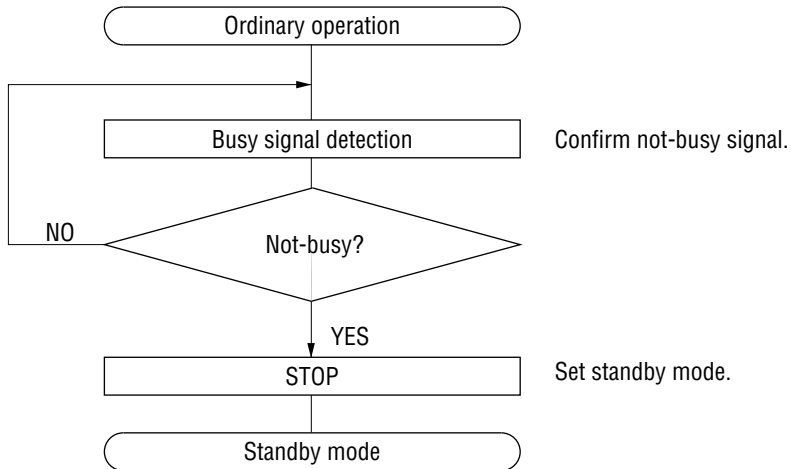





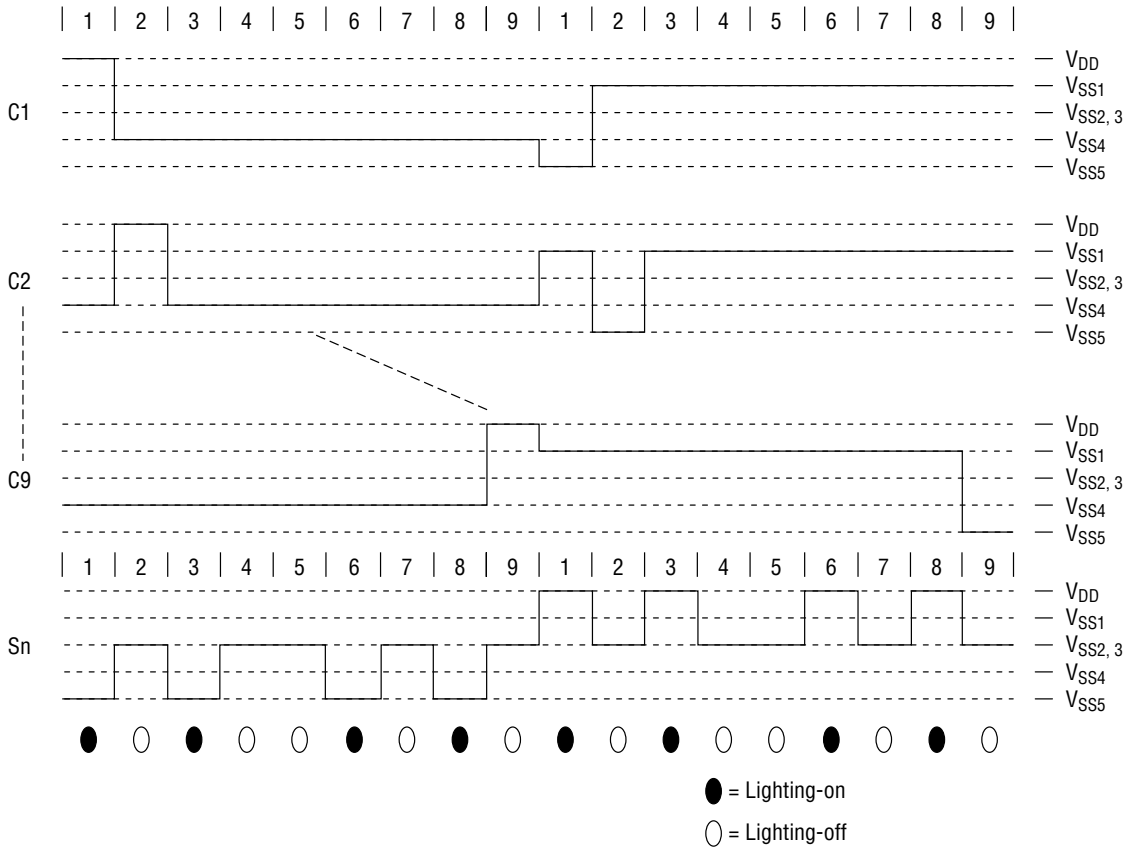



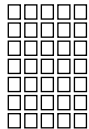
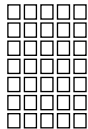
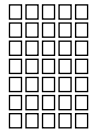
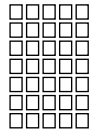
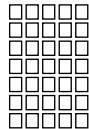
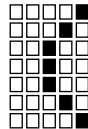
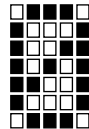

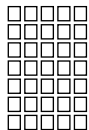
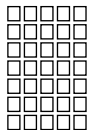
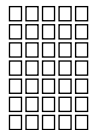
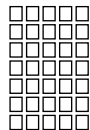
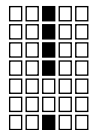
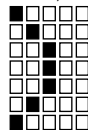
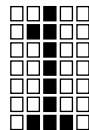

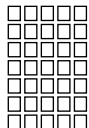
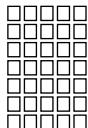
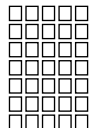
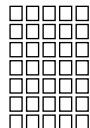
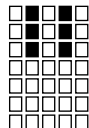
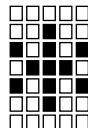
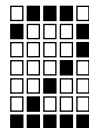
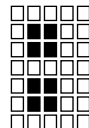
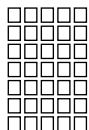
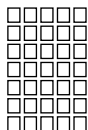
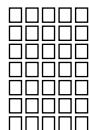
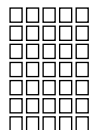
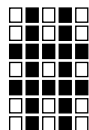
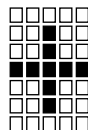
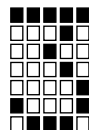
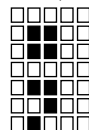
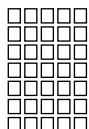
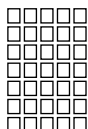
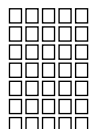
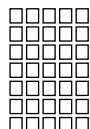
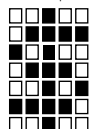
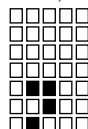

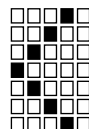
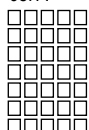
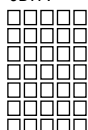
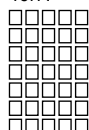
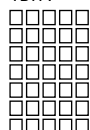
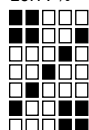
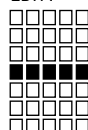
In 1/9 duty

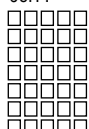
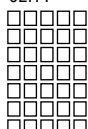
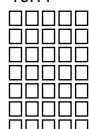
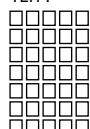
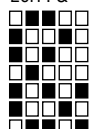
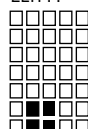

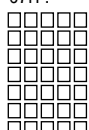
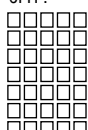
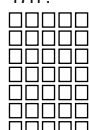
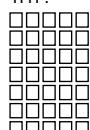
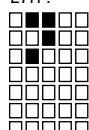
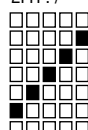
Codes and Character Fonts of Code -01

00H : 	08H : 	10H : 	18H : 	20H : SP 	28H : ( 	30H : 0 	38H : 8 
01H : 	09H : 	11H : 	19H : 	21H : ! 	29H : ) 	31H : 1 	00H : 9 
02H : 	0AH : 	12H : 	1AH : 	22H : " 	2AH : * 	32H : 2 	3AH : : 
03H : 	0BH : 	13H : 	1BH : 	23H : # 	2BH : + 	33H : 3 	3BH : ; 
04H : 	0CH : 	14H : 	1CH : 	24H : \$ 	2CH : , 	34H : 4 	3CH : < 
05H : 	0DH : 	15H : 	1DH : 	25H : % 	2DH : - 	35H : 5 	3DH : = 
06H : 	0EH : 	16H : 	1EH : 	26H : & 	2EH : . 	36H : 6 	3EH : > 
07H : 	0FH : 	17H : 	1FH : 	27H : ' 	2FH : / 	37H : 7 	3FH : ? 

40H : @ 	48H : H 	50H : P 	58H : X 	60H : ` (grave accent) 	68H : h 	70H : p 	78H : x 
41H : A 	49H : I 	51H : Q 	59H : Y 	61H : a 	69H : i 	71H : q 	79H : y 
42H : B 	4AH : J 	52H : R 	5AH : Z 	62H : b 	64H : j 	72H : r 	7AH : z 
43H : C 	4BH : K 	53H : S 	5BH : [ (left bracket) 	63H : c 	6BH : k 	73H : s 	7BH : { (left curly brace) 
44H : D 	4CH : L 	54H : T 	5CH : \ (backslash) 	64H : d 	6CH : l 	74H : t 	7CH :   (vertical bar) 
45H : E 	4DH : M 	55H : U 	5DH : ] (right bracket) 	65H : e 	6DH : m 	75H : u 	7OH : } (right curly brace) 
46H : F 	4EH : N 	56H : V 	5EH : ^ (circumflex) 	66H : f 	6EH : n 	76H : v 	7EH : ~ (tilde) 
47H : G 	4FH : O 	57H : W 	5FH : _ (underscore) 	67H : g 	6FH : o 	77H : w 	7FH : £ (pound sign) 



80H : Ä	88H : ä	90H : ñ	98H : !	A0H : ¥	A8H : イ	B0H : 一	B8H : ク
81H : Å	89H : å	91H : õ	99H : i	A1H : 。	49H : ウ	B1H : ア	B9H : ケ
82H : Æ	8AH : à	92H : Ù	9AH : ç	A2H : Γ	AAH : I	B2H : イ	BAH : コ
83H : Ç	8BH : á	93H : ü	9BH : §	A3H : J	ABH : オ	B3H : ウ	BBH : サ
84H : É	8CH : æ	94H : α	9CH : °	A4H : 、	aCH : ¥	B4H : エ	BCH : シ
85H : Ñ	8DH : ç	95H : β	9DH : ¨	A5H : ・	ADH : 1	B5H : オ	BDH : ス
86H : Ö	8EH : é	96H : Ø	9EH : °	A6H : ヲ	AEH : ヨ	B6H : カ	BEH : セ
87H : Û	8FH : è	97H : ø	9FH : ç	27H : ア	2FH : ツ	37H : キ	3FH : ソ

C0H: タ 	C8H: ネ 	D0H: ミ 	D8H: リ 	E0H: ▲ 	E8H: ↑ 	F0H: Γ 	F8H: ε 
C1H: チ 	C9H: ノ 	D1H: ム 	D9H: ル 	E1H: ▼ 	E9H: ↓ 	F1H: Δ 	F9H: λ 
C2H: ツ 	CAH: ハ 	D2H: メ 	DAH: レ 	E2H: 千 	EAH: 月 	F2H: θ 	FAH: π 
C3H: テ 	CBH: ヒ 	D3H: モ 	DBH: ロ 	E3H: 万 	EBH: 日 	F3H: ㊦ 	FBH: σ 
C4H: ト 	CCH: フ 	D4H: ヤ 	DCH: ワ 	E4H: 円 	ECH: II 	F4H: Σ 	FCH: ü 
C5H: ナ 	CDH: ベ 	D5H: ユ 	DDH: ン 	E5H: 〒 	EDH: III 	F5H: Φ 	FDH: 
C6H: ニ 	CEH: ホ 	D6H: ヨ 	DEH: ° 	E6H: → 	EEH: ≡ 	FEH: Ψ 	FEH: 
C7H: ヌ 	CFH: マ 	D7H: ラ 	DFH: ° 	E7H: ← 	EFH: ≡ 	F7H: Ω 	FFH: ■ 

APPLICATION CIRCUITS

Example 1

[1/16 duty, parallel interface, crystal oscillation circuit and bias voltage generator used]

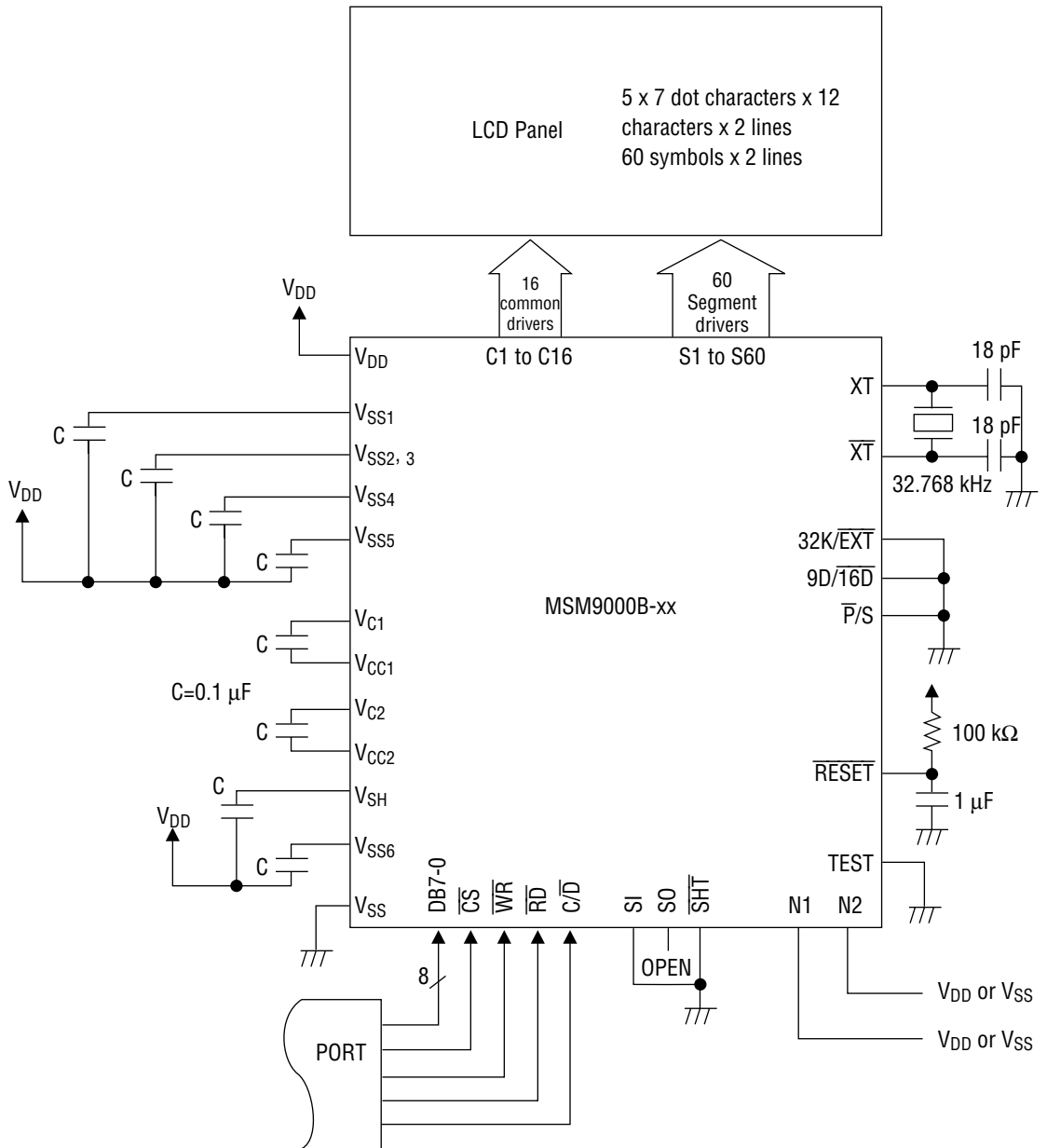

**Example 2**

[1/9 duty, serial interface, 32kHz external clock input and bias voltage generator used]

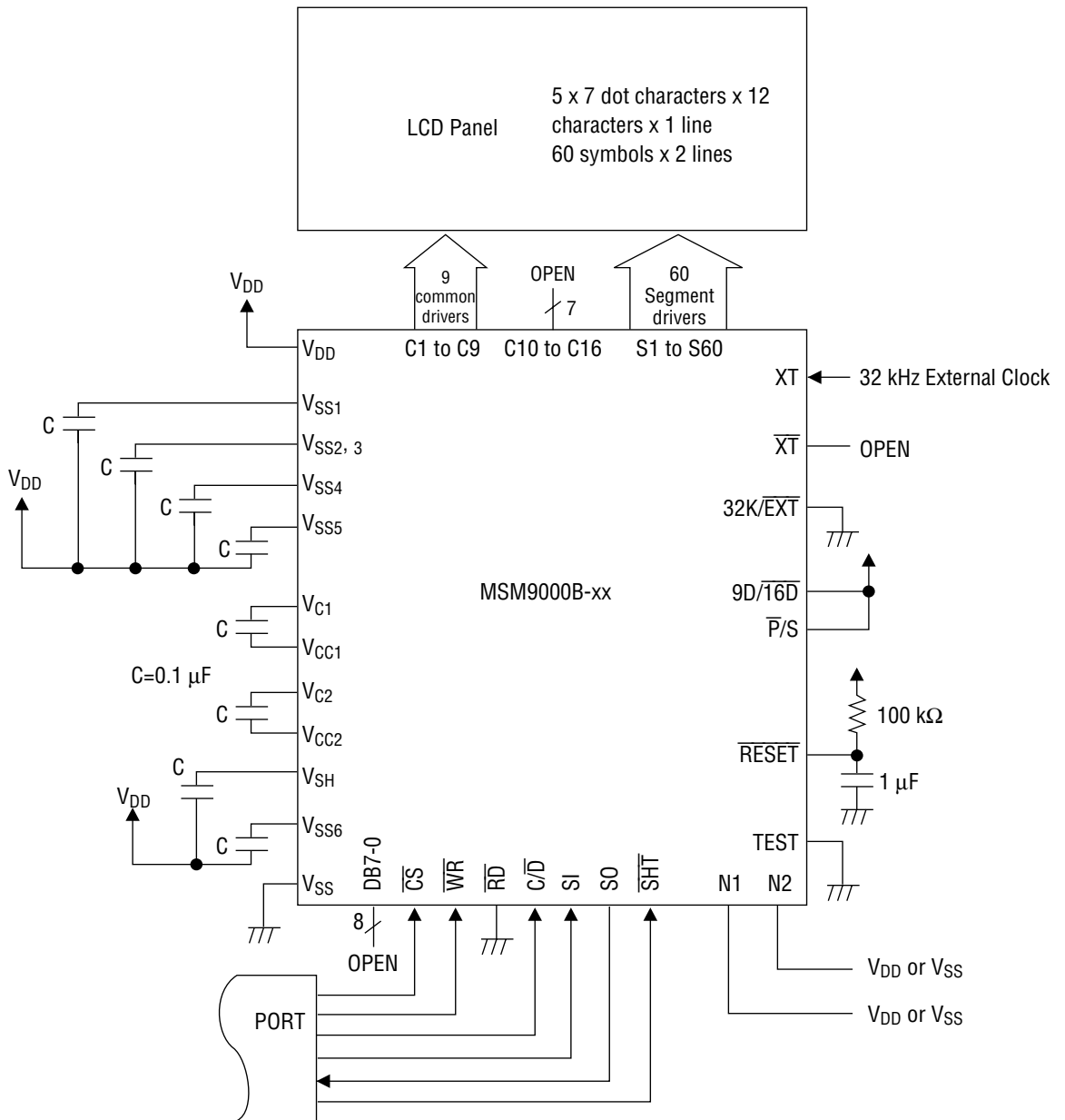

### PAD CONFIGURATION

#### Pad Layout

Chip size: 4.76 × 3.29 mm

Bump size: 78 × 100 μm

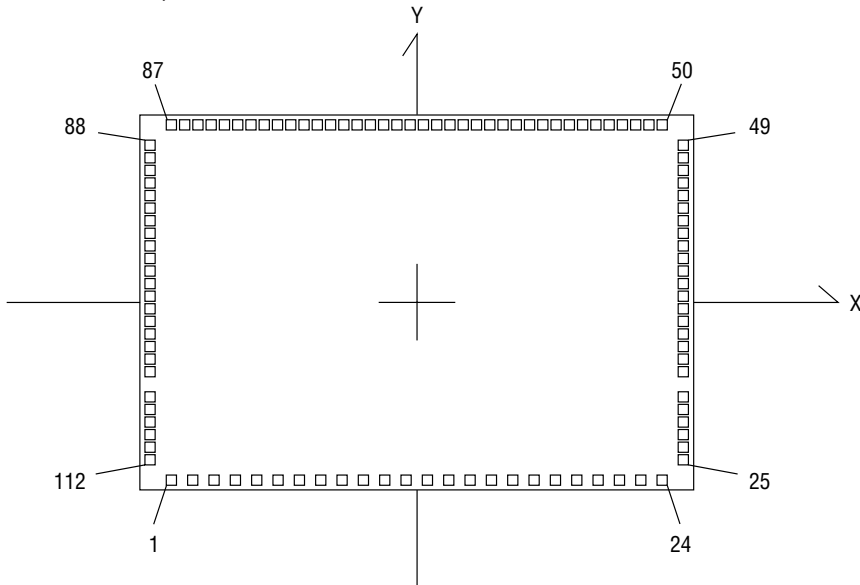

#### Pad Coordinates

Pad No.	Pad Name	X (μm)	Y (μm)	Pad No.	Pad Name	X (μm)	Y (μm)
1	V <sub>SS</sub>	-2012	-1508	21	V <sub>CC1</sub>	1487	-1508
2	$\overline{CS}$	-1837	-1508	22	V <sub>C1</sub>	1662	-1508
3	$\overline{C/D}$	-1662	-1508	23	V <sub>SH</sub>	1837	-1508
4	$\overline{RD}$	-1487	-1508	24	V <sub>SS6</sub>	2012	-1508
5	$\overline{WR}$	-1312	-1508	25	V <sub>CC2</sub>	2194	-1375
6	SI	-1137	-1508	26	V <sub>C2</sub>	2194	-1255
7	$\overline{SHT}$	-962	-1508	27	V <sub>SS1</sub>	2194	-1135
8	SO	-787	-1508	28	V <sub>SS2,3</sub>	2194	-1015
9	DB7	-612	-1508	29	V <sub>SS4</sub>	2194	-895
10	DB6	-437	-1508	30	V <sub>SS5</sub>	2194	-775
11	DB5	-262	-1508	31	COM9	2194	-605
12	DB4	-88	-1508	32	COM10	2194	-495
13	DB3	88	-1508	33	COM11	2194	-385
14	DB2	262	-1508	34	COM12	2194	-275
15	DB1	437	-1508	35	COM13	2194	-165
16	DB0	612	-1508	36	COM14	2194	-55
17	V <sub>DD</sub>	787	-1508	37	COM15	2194	55
18	TEST	962	-1508	38	COM16	2194	165
19	N1	1137	-1508	39	SEG60	2194	275
20	N2	1312	-1508	40	SEG59	2194	385

Pad No.	Pad Name	X ( $\mu\text{m}$ )	Y ( $\mu\text{m}$ )	Pad No.	Pad Name	X ( $\mu\text{m}$ )	Y ( $\mu\text{m}$ )
41	SEG58	2194	495	81	SEG18	-1337	1508
42	SEG57	2194	605	82	SEG17	-1444	1508
43	SEG56	2194	715	83	SEG16	-1552	1508
44	SEG55	2194	825	84	SEG15	-1659	1508
45	SEG54	2194	935	85	SEG14	-1765	1508
46	SEG53	2194	1045	86	SEG13	-1872	1508
47	SEG52	2194	1155	87	SEG12	-1980	1508
48	SEG51	2194	1265	88	SEG11	-2194	1375
49	SEG50	2194	1375	89	SEG10	-2194	1265
50	SEG49	1980	1508	90	SEG9	-2194	1155
51	SEG48	1872	1508	91	SEG8	-2194	1045
52	SEG47	1765	1508	92	SEG7	-2194	935
53	SEG46	1659	1508	93	SEG6	-2194	825
54	SEG45	1552	1508	94	SEG5	-2194	715
55	SEG44	1444	1508	95	SEG4	-2194	605
56	SEG43	1337	1508	96	SEG3	-2194	495
57	SEG42	1231	1508	97	SEG2	-2194	385
58	SEG41	1123	1508	98	SEG1	-2194	275
59	SEG40	1016	1508	99	COM8	-2194	165
60	SEG39	910	1508	100	COM7	-2194	55
61	SEG38	803	1508	101	COM6	-2194	-55
62	SEG37	695	1508	102	COM5	-2194	-165
63	SEG36	588	1508	103	COM4	-2194	-275
64	SEG35	482	1508	104	COM3	-2194	-385
65	SEG34	374	1508	105	COM2	-2194	-495
66	SEG33	267	1508	106	COM1	-2194	-605
67	SEG32	161	1508	107	$\overline{\text{RESET}}$	-2194	-775
68	SEG31	54	1508	108	32K/EXT	-2194	-895
69	SEG30	54	1508	109	9D/ $\overline{\text{T6D}}$	-2194	-1015
70	SEG29	-161	1508	110	$\overline{\text{P/S}}$	-2194	-1135
71	SEG28	-267	1508	111	$\overline{\text{XT}}$	-2194	-1255
72	SEG27	-374	1508	112	XT	-2194	-1375
73	SEG26	-482	1508				
74	SEG25	-588	1508				
75	SEG24	-695	1508				
76	SEG23	-803	1508				
77	SEG22	-910	1508				
78	SEG21	-1016	1508				
79	SEG20	-1123	1508				
80	SEG19	-1231	1508				