



# TN8R03 — ExPD (Excellent Power Device) Switching Regulator IC for RCC Method Power Supplies Applications

## Features

- Original control IC for Delay RCC-type.
- High voltage power MOSFET with current sense.
- Overload protection.
- Only few external components required.
- Small Full-Isolation package : TO-220FI5H.

## Specifications

### Absolute Maximum Ratings at Ta=25°C

Parameter	Symbol	Conditions	Ratings	Unit
Drain-to-Source Voltage	V <sub>DS</sub>		800	V
Drain Current (DC)	I <sub>D</sub>		4.5	A
Drain Current (Pulse)	I <sub>DP</sub>	PW≤10μs, duty cycle≤1%	13.5	A
IC Input Voltage	V <sub>IN</sub>		30	V
Allowable Power Dissipation	P <sub>D</sub>		2.0	W
		T <sub>c</sub> =25°C	35	W
Operating Temperature	T <sub>opr</sub>		-25 to +125	°C
Junction Temperature	T <sub>J</sub>		150	°C
Storage Temperature	T <sub>stg</sub>		-55 to +150	°C

### Electrical Characteristics at Ta=25°C

Parameter	Symbol	Conditions	Ratings			Unit
			min	typ	max	
[MOSFET]						
Drain-to-Source Breakdown Voltage	V <sub>(BR)DSS</sub>	I <sub>D</sub> =1mA, V <sub>DELAY</sub> =0	800			V
Zero-Gate Voltage Drain Current	I <sub>DSS</sub>	V <sub>DS</sub> =800V, V <sub>DELAY</sub> =0			1.0	mA
Cutoff Voltage	V <sub>GS(off)</sub>	V <sub>DS</sub> =10V, I <sub>D</sub> =1mA	3.0		4.0	V
Static Drain-to-Source On-State Resistance	R <sub>DS(on)</sub>	I <sub>D</sub> =2.3A, V <sub>DELAY</sub> =15V		1.75	2.3	Ω
Input Capacitance	C <sub>iss</sub>	V <sub>DS</sub> =20V, f=1MHz		1450		pF
Output Capacitance	C <sub>oss</sub>	V <sub>DS</sub> =20V, f=1MHz		220		pF
[IC]						
Restriction of Drive Voltage	V <sub>IN(OV)</sub>	I <sub>IN</sub> =1mA, V <sub>FB</sub> =0	30			V
Detection Voltage of Feedback and Overload Amplifier	V <sub>FB</sub>	V <sub>DELAY</sub> , V <sub>IN</sub> =10V, I <sub>IN</sub> =50mA		2.0		V

- Any and all SANYO products described or contained herein do not have specifications that can handle applications that require extremely high levels of reliability, such as life-support systems, aircraft's control systems, or other applications whose failure can be reasonably expected to result in serious physical and/or material damage. Consult with your SANYO representative nearest you before using any SANYO products described or contained herein in such applications.
- SANYO assumes no responsibility for equipment failures that result from using products at values that exceed, even momentarily, rated values (such as maximum ratings, operating condition ranges, or other parameters) listed in products specifications of any and all SANYO products described or contained herein.

# TN8R03

## Recommend Operating Conditions at Ta=25°C

Parameter	Symbol	Conditions	Ratings	Unit
IC Input Voltage	V <sub>IN</sub>		±10 to ±25	V
Operating Frequency	F <sub>OSC</sub>		20 to 200	kHz

## Package Dimensions

unit : mm

2226

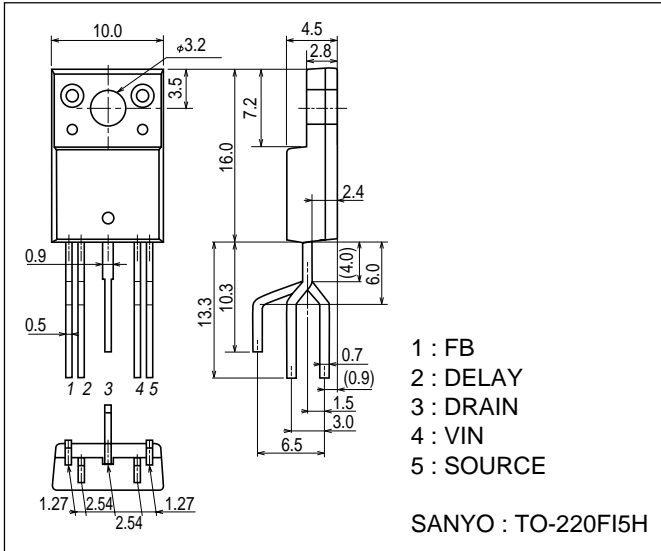

## Block Diagram

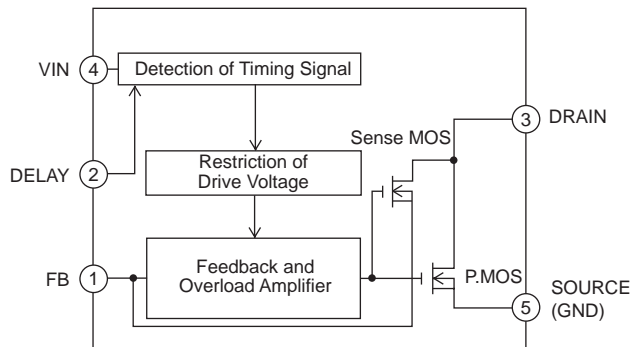

## Pin Definitions and Functions

Pin No.	Symbol	Function
1	FB	Input for feedback voltage and current sense
2	DELAY	Input for timing signal
3	DRAIN	Power MOSFET Drain
4	VIN	Input for Start-up voltage and drive voltage
5	SOURCE (GND)	Power MOSFET Source (Ground)

# TN8R03

## Circuit Function Diagram

[Feedback control]

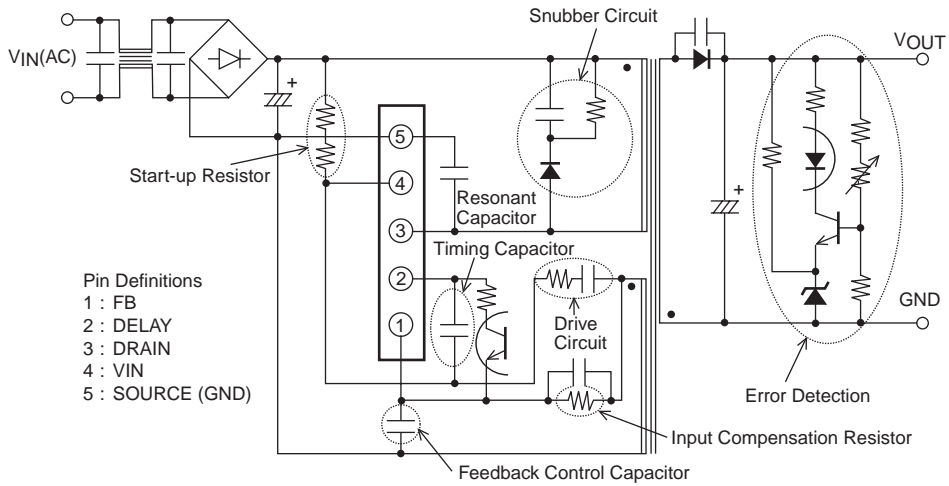

[Semi-regulated control]

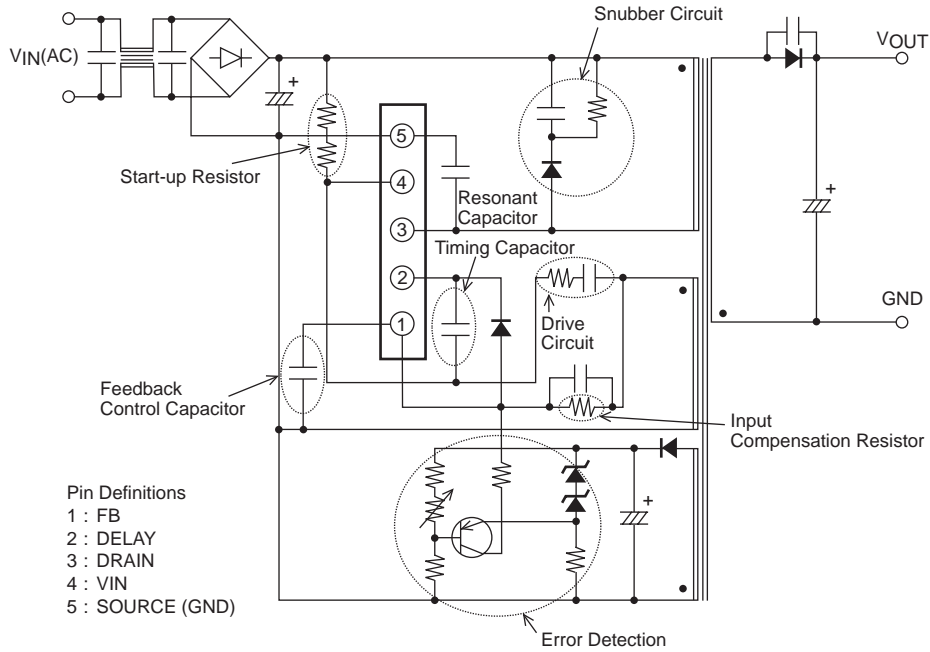

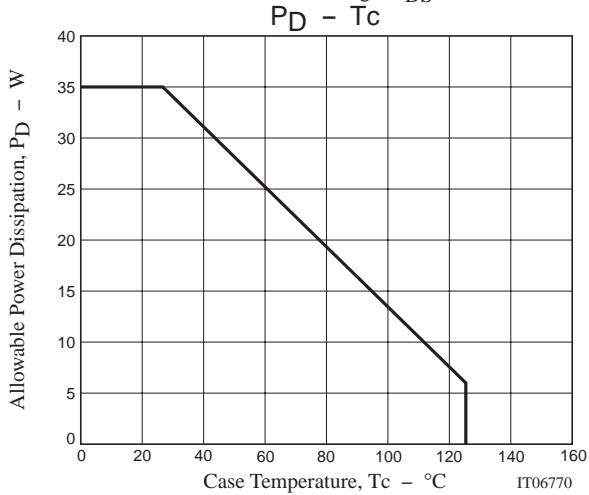
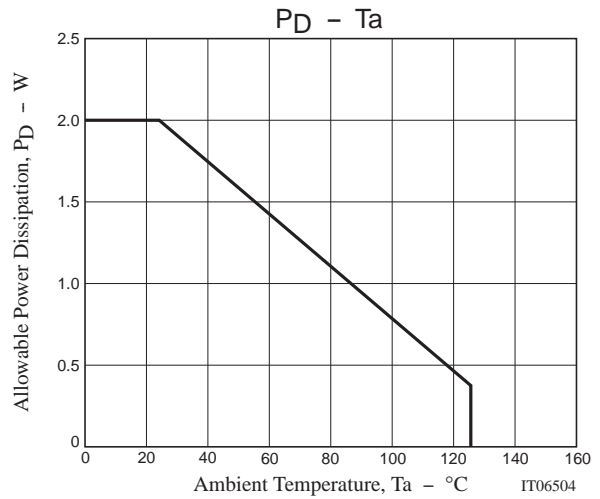
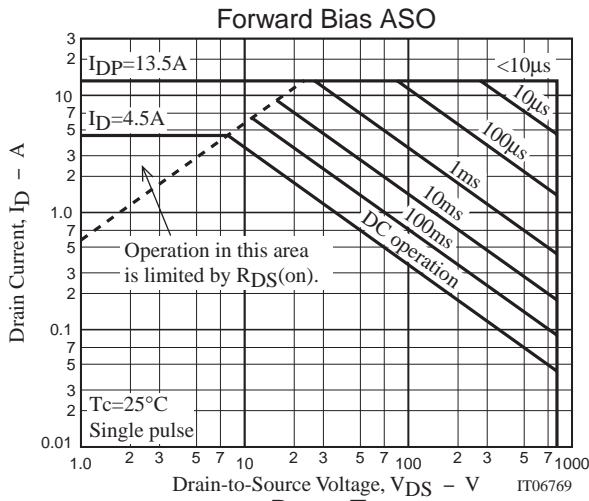

- Specifications of any and all SANYO products described or contained herein stipulate the performance, characteristics, and functions of the described products in the independent state, and are not guarantees of the performance, characteristics, and functions of the described products as mounted in the customer's products or equipment. To verify symptoms and states that cannot be evaluated in an independent device, the customer should always evaluate and test devices mounted in the customer's products or equipment.
- SANYO Electric Co., Ltd. strives to supply high-quality high-reliability products. However, any and all semiconductor products fail with some probability. It is possible that these probabilistic failures could give rise to accidents or events that could endanger human lives, that could give rise to smoke or fire, or that could cause damage to other property. When designing equipment, adopt safety measures so that these kinds of accidents or events cannot occur. Such measures include but are not limited to protective circuits and error prevention circuits for safe design, redundant design, and structural design.
- In the event that any or all SANYO products(including technical data, services) described or contained herein are controlled under any of applicable local export control laws and regulations, such products must not be exported without obtaining the export license from the authorities concerned in accordance with the above law.
- No part of this publication may be reproduced or transmitted in any form or by any means, electronic or mechanical, including photocopying and recording, or any information storage or retrieval system, or otherwise, without the prior written permission of SANYO Electric Co., Ltd.
- Any and all information described or contained herein are subject to change without notice due to product/technology improvement, etc. When designing equipment, refer to the "Delivery Specification" for the SANYO product that you intend to use.
- Information (including circuit diagrams and circuit parameters) herein is for example only ; it is not guaranteed for volume production. SANYO believes information herein is accurate and reliable, but no guarantees are made or implied regarding its use or any infringements of intellectual property rights or other rights of third parties.

This catalog provides information as of January, 2004. Specifications and information herein are subject to change without notice.