

DELPHI SERIES



FEATURES

- ◆ High Efficiency: 93.0% @ 12Vin, 5.0V/3A out
- ◆ Small size and low profile:
 - 0.80" x 0.45" x 0.27" (SMD)
 - 0.90" x 0.40" x 0.25" (SIP)
- ◆ Standard footprint and pinout
- ◆ Resistor-based trim
- ◆ Output voltage programmable from 0.75Vdc to 5.5Vdc via external resistors
- ◆ Pre-bias startup
- ◆ No minimum load required
- ◆ Fixed frequency operation
- ◆ Input UVLO, OCP
- ◆ Remote ON/OFF
- ◆ ISO 9001, TL 9000, ISO 14001, QS9000, OHSAS18001 certified manufacturing facility
- ◆ UL/cUL 60950 (US & Canada) Recognized, and TUV (EN60950) - pending
- ◆ CE mark meets 73/23/EEC and 93/68/EEC - pending

Delphi series DNT12 Non-Isolated Point of Load DC/DC Power Modules: 8.3~14Vin, 0.75~5.5Vo, 3A

The Delphi series DNT12, 8.3V~14V input, 3A single output, non-isolated point of load DC/DC converters are the latest offering from a world leader in power systems technology and manufacturing -- Delta Electronics, Inc. The DNT12, 3A series provides a programmable output voltage from 0.75V to 5.5V using external resistors. This product family is available in a surface mount or SIP package and provides up to 3A of current in an industry standard footprint. With creative design technology and optimization of component placement, these converters possess outstanding electrical and thermal performance and extremely high reliability under highly stressful operating conditions. The DNT12, 3A modules have excellent thermal performance and can provide full output current at up to 85°C ambient temperature with no airflow.

OPTIONS

- ◆ Positive on/off logic
- ◆ SIP package

APPLICATIONS

- ◆ Telecom/DataCom
- ◆ Distributed power architectures
- ◆ Servers and workstations
- ◆ LAN/WAN applications
- ◆ Data processing applications

TECHNICAL SPECIFICATIONS

($T_A = 25^\circ\text{C}$, airflow rate = 300 LFM, $V_{in} = 12\text{Vdc}$, nominal V_{out} unless otherwise noted.)

| PARAMETER | NOTES and CONDITIONS | DNT12S0A0S03NFA | | | |
|--|--|-----------------|-------------|--------------|------------------|
| | | Min. | Typ. | Max. | Units |
| ABSOLUTE MAXIMUM RATINGS | | | | | |
| Input Voltage (Continuous) | | 0 | | 15 | Vdc |
| Operating Temperature | Refer to Figure 28 for measuring point | -40 | | +125 | $^\circ\text{C}$ |
| Storage Temperature | | -55 | | +125 | $^\circ\text{C}$ |
| INPUT CHARACTERISTICS | | | | | |
| Operating Input Voltage | | 8.3 | 12 | 14 | V |
| Input Under-Voltage Lockout | | | | | |
| Turn-On Voltage Threshold | | | 7.90 | | V |
| Turn-Off Voltage Threshold | | | 7.70 | | V |
| Maximum Input Current | $V_{in}=8.3\text{V}$, $V_o=5\text{V}$, $I_o=3\text{A}$ | | | 2.2 | A |
| No-Load Input Current | $V_o=5\text{V}$ | | 50 | 70 | mA |
| Off Converter Input Current | | | 2 | 10 | mA |
| Inrush Transient | $V_{in} = V_{in,min}$ to $V_{in,max}$, $I_o = I_{o,min}$ to $I_{o,max}$ | | | 0.4 | A ^2S |
| Recommended Input Fuse | | | TBD | | A |
| OUTPUT CHARACTERISTICS | | | | | |
| Output Voltage Set Point | $V_{in}=12\text{V}$, $I_o=I_{o,max}$ | -2.0 | $V_{o,set}$ | +2.0 | % $V_{o,set}$ |
| Output Voltage Adjustable Range | | 0.7525 | | 5.5 | V |
| Output Voltage Regulation | | | | | |
| Over Line | $V_{in}=V_{in,min}$ to $V_{in,max}$ | | 0.3 | | % $V_{o,set}$ |
| Over Load | $I_o=I_{o,min}$ to $I_{o,max}$ | | 0.4 | | % $V_{o,set}$ |
| Over Temperature | $T_a = -40^\circ\text{C}$ to 85°C | | 0.4 | | % $V_{o,set}$ |
| Total Output Voltage Range | Over sample load, line and temperature | -3.0 | | +3.0 | % $V_{o,set}$ |
| Output Voltage Ripple and Noise | | | | | |
| Peak-to-Peak | 5Hz to 20MHz bandwidth $V_{in} = \text{min to max}$, $I_o = \text{min to max}$, 1 μF ceramic, 10 μF Tan | | 50 | 80 | mV |
| RMS | $V_{in} = \text{min to max}$, $I_o = \text{min to max}$, 1 μF ceramic, 10 μF Tan | | 20 | 30 | mV |
| Output Current Range | | 0 | | 3 | A |
| Output Voltage Over-shoot at Start-up | | | | | |
| Output DC Current-Limit Inception | | | 200 | | % I_o |
| Output Short-Circuit Current (Hiccup mode) | $I_o, s/c$ | | 1.5 | | Adc (rms) |
| DYNAMIC CHARACTERISTICS | | | | | |
| Dynamic Load Response | | | | | |
| Positive Step Change in Output Current | 10 μF Tan & 1 μF ceramic load cap, 2.5A/ μs 50% I_o , max to 100% I_o , max | | 200 | | mVpk |
| Negative Step Change in Output Current | 100% I_o , max to 50% I_o , max | | 200 | | mVpk |
| Setting Time to 10% of Peak Deviation | | | 25 | | μs |
| Turn-On Transient | | | | | |
| Start-Up Time, From On/Off Control | $I_o = I_{o,max}$ $V_{on/off}$, $V_o = 10\%$ of $V_{o,set}$ | | 7 | 10 | ms |
| Start-Up Time, From Input | $V_{in} = V_{in,min}$, $V_o = 10\%$ of $V_{o,set}$ | | 7 | 10 | ms |
| Maximum Output Startup Capacitive Load | | | | | |
| | Full load; ESR $\geq 1\text{m}\Omega$ | | | 1000 | μF |
| | Full load; ESR $\geq 10\text{m}\Omega$ | | | 3000 | μF |
| EFFICIENCY | | | | | |
| $V_o=0.75\text{V}$ | $V_{in}=12\text{V}$, $I_o=I_{o,max}$ | | 72.0 | | % |
| $V_o=1.2\text{V}$ | $V_{in}=12\text{V}$, $I_o=I_{o,max}$ | | 80.0 | | % |
| $V_o=1.5\text{V}$ | $V_{in}=12\text{V}$, $I_o=I_{o,max}$ | | 83.0 | | % |
| $V_o=1.8\text{V}$ | $V_{in}=12\text{V}$, $I_o=I_{o,max}$ | | 85.0 | | % |
| $V_o=2.5\text{V}$ | $V_{in}=12\text{V}$, $I_o=I_{o,max}$ | | 88.0 | | % |
| $V_o=3.3\text{V}$ | $V_{in}=12\text{V}$, $I_o=I_{o,max}$ | | 90.0 | | % |
| $V_o=5.0\text{V}$ | $V_{in}=12\text{V}$, $I_o=I_{o,max}$ | | 93.0 | | % |
| FEATURE CHARACTERISTICS | | | | | |
| Switching Frequency | | | | | |
| ON/OFF Control, (for Negative logic) | | | 300 | | kHz |
| Logic Low Voltage | | | | | |
| Logic Low Voltage | Module On, $V_{on/off}$ | -0.2 | | 0.3 | V |
| Logic High Voltage | Module Off, $V_{on/off}$ | 2.5 | | $V_{in,max}$ | V |
| Logic Low Current | | | | | |
| Logic Low Current | Module On, $I_{on/off}$ | | | 10 | μA |
| Logic High Current | Module Off, $I_{on/off}$ | | 0.2 | 1 | mA |
| ON/OFF Control, (for Positive logic) | | | | | |
| Logic High Voltage | | | | | |
| Logic High Voltage | Module On, $V_{on/off}$ | | | $V_{in,max}$ | V |
| Logic Low Voltage | Module Off, $V_{on/off}$ | -0.2 | | 0.3 | V |
| Logic High Current | | | | | |
| Logic High Current | Module On, $I_{on/off}$ | | | 10 | μA |
| Logic Low Current | Module Off, $I_{on/off}$ | | 0.2 | 1 | mA |
| GENERAL SPECIFICATIONS | | | | | |
| MTBF | $I_o=I_{o,max}$, $T_a=25^\circ\text{C}$ | | 38.29 | | M hours |
| Weight | | | 2.3 | | grams |



ELECTRICAL CHARACTERISTICS CURVES

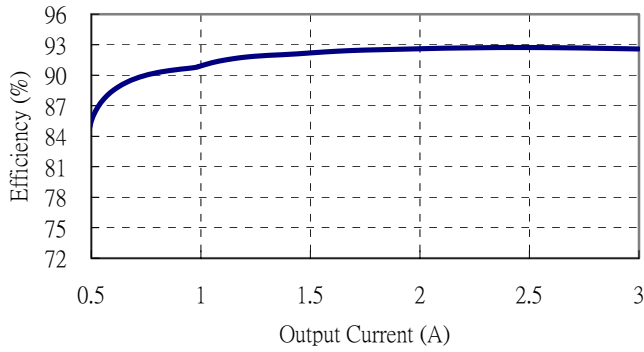

Figure 1: Converter efficiency vs. output current
(12V in, 5V output voltage)

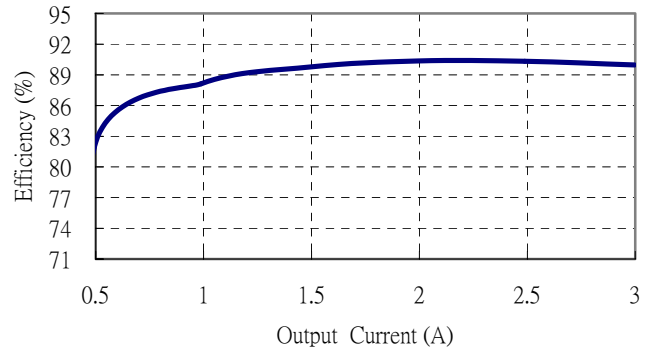

Figure 2: Converter efficiency vs. output current
(12V in, 3.3V output voltage)

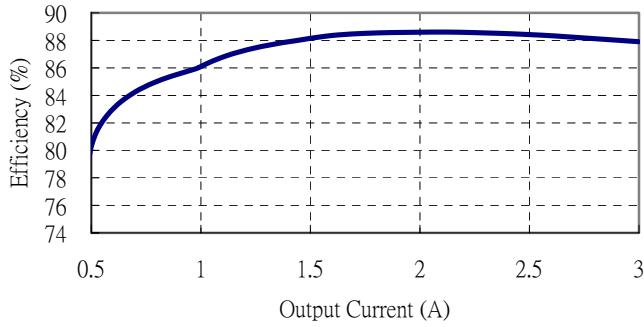

Figure 3: Converter efficiency vs. output current
(12V in, 2.5V output voltage)

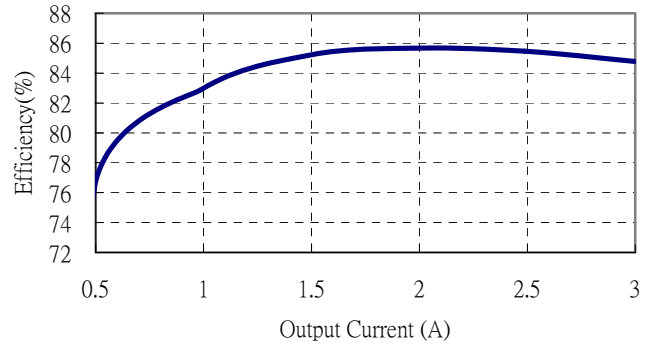

Figure 4: Converter efficiency vs. output current
(12V in, 1.8V output voltage)

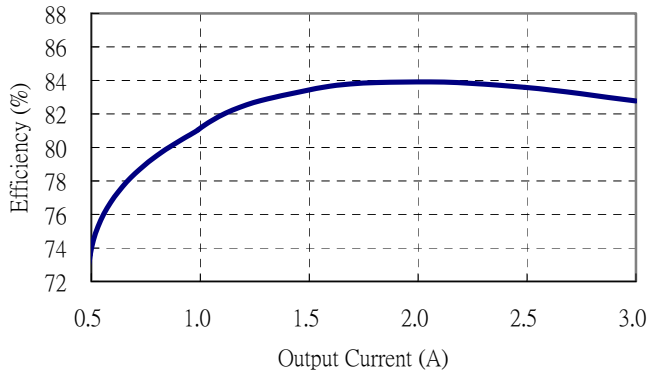

Figure 5: Converter efficiency vs. output current
(12V in, 1.5V output voltage)

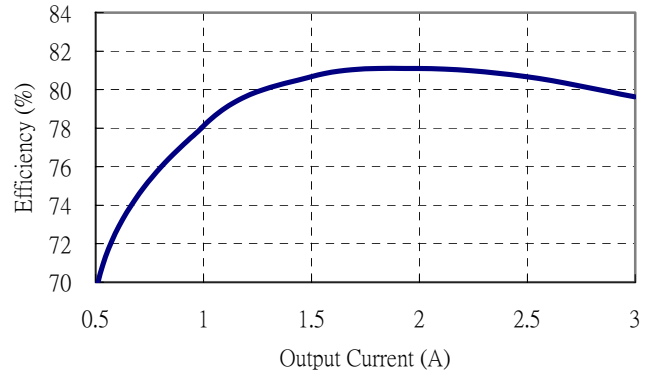

Figure 6: Converter efficiency vs. output current
(12V in, 1.2V output voltage)



ELECTRICAL CHARACTERISTICS CURVES

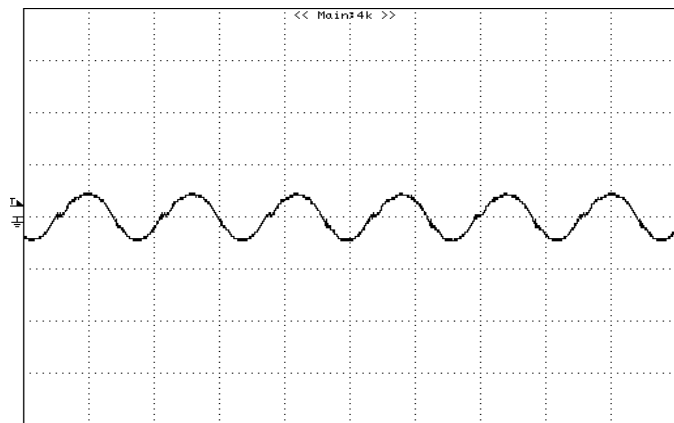

Figure 7: Output ripple & noise at 12Vin, 5.0V/3A out
pk-pk :45.8mV, rms :17.8mV (50mV/div,2uS/div)

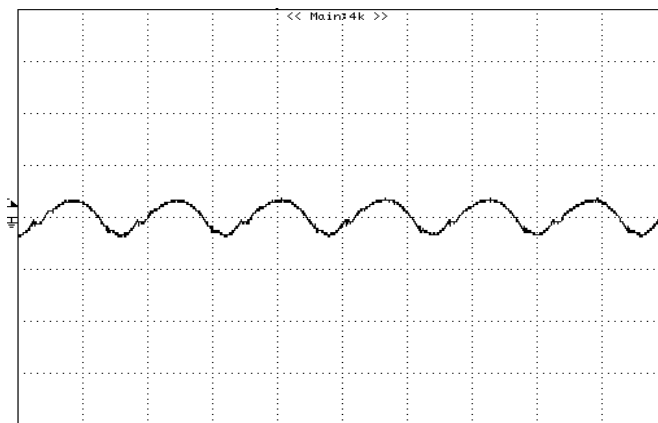

Figure 8: Output ripple & noise at 12Vin, 3.3V/3A out
pk-pk :37.5mV, rms :11.6mV (50mV/div,2uS/div)

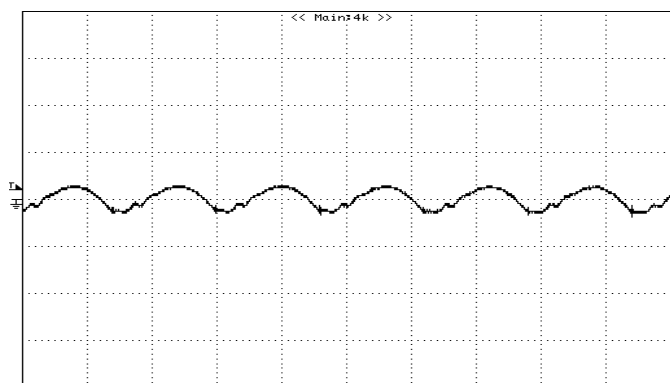

Figure 9: Output ripple & noise at 12Vin, 2.5V/3A out
pk-pk:33.3mV, rms:9.4mV (50mV/div, 2uS/div)

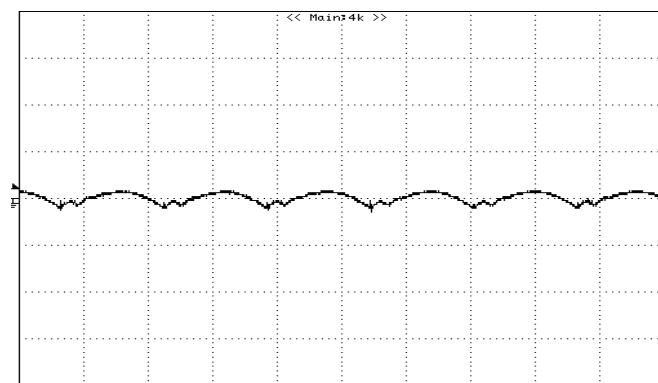

Figure 10: Output ripple & noise at 12Vin, 1.2V/3A out
pk-pk: 18.7mV, rms: 3.9mV (50mV/div, 2uS/div)

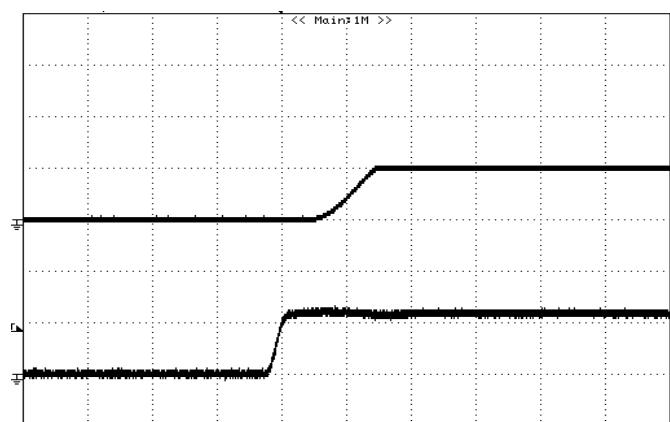

Figure 11: Turn on delay time at 12Vin, 5.0V/3A out
(5mS/div)
Top trace: Vout, 5V/div; Bottom trace: Vin, 10V/div

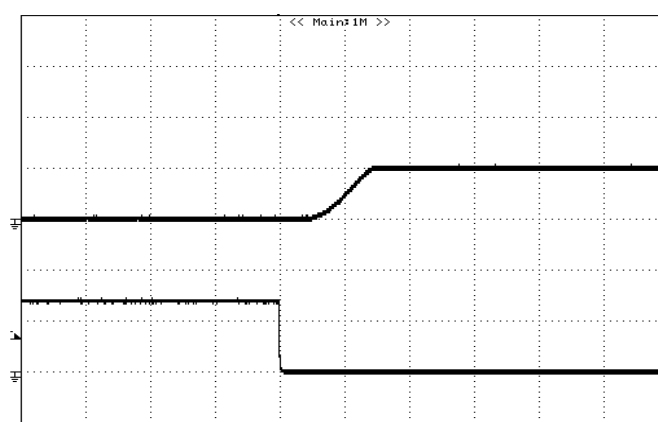

Figure 12: Turn on delay time at Remote On/Off, 5.0V/3A out
(5mS/div).
Top trace: Vout, 5V/div; Bottom trace: On/Off, 5.0V/div.



ELECTRICAL CHARACTERISTICS CURVES

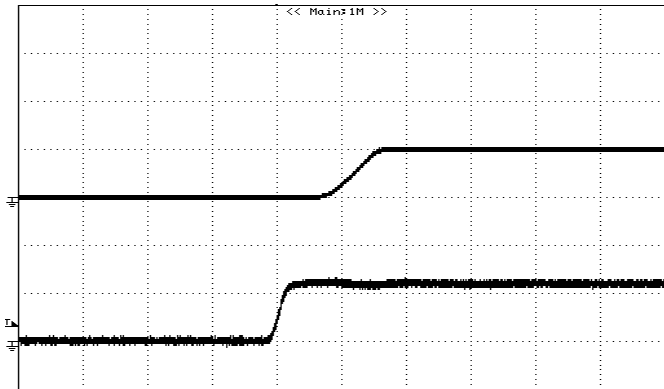

Figure 13: Turn on Using Remote On/Off with external capacitors ($C_o = 3000 \mu F$), 5.0V/3A out (resistive load) (5mS/div)
Top trace: Vout, 5V/div; Bottom trace: Vin, 10V/div

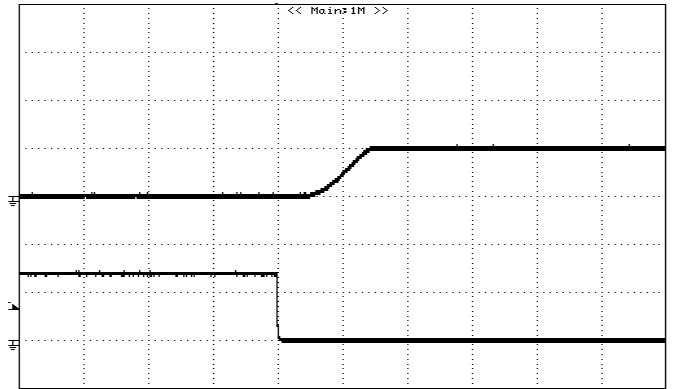

Figure 14: Turn on Using Input On/Off with external capacitors ($C_o = 3000 \mu F$), 5.0V/3A out (resistive load) (5mS/div)
Top trace: Vout, 5V/div; Bottom trace: On/Off, 5V/div

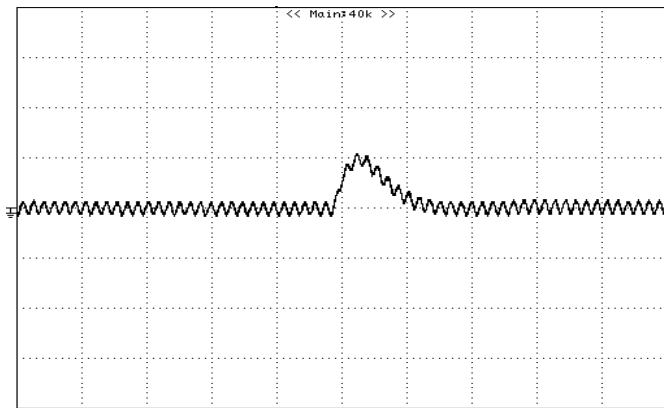

Figure 15: Typical transient response to step load change at 2.5A/ μS from 100% to 50% of I_o , max at 12Vin, 5.0V out ($C_{out} = 1\mu F$ ceramic, 10 μF tantalum) (200mV/div, 20 μS /div)

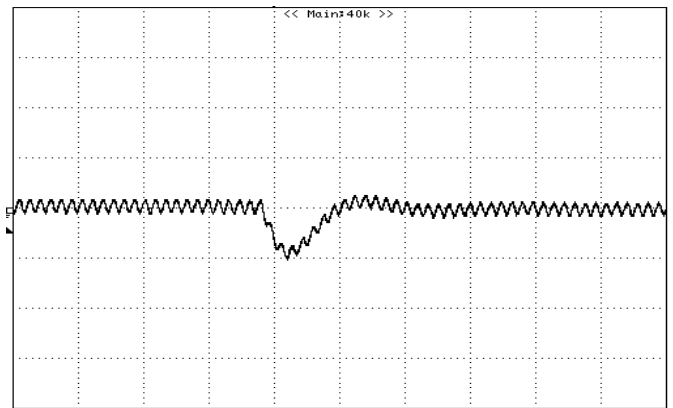

Figure 16: Typical transient response to step load change at 2.5A/ μS from 50% to 100% of I_o , max at 12Vin, 5.0V out ($C_{out} = 1\mu F$ ceramic, 10 μF tantalum) (200mV/div, 20 μS /div)

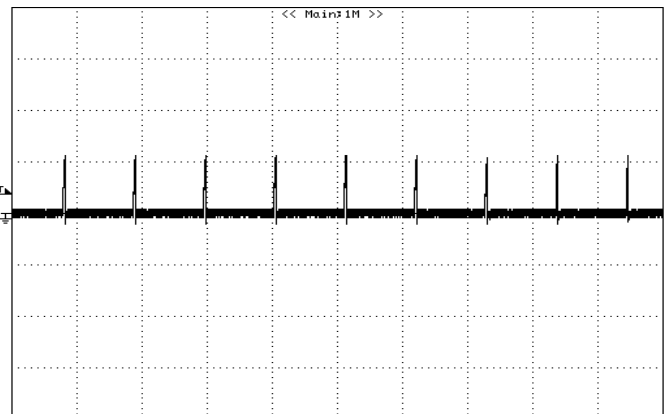

Figure 17: Output short circuit current 12Vin, 0.75Vout (10A/div, 50mS/div)

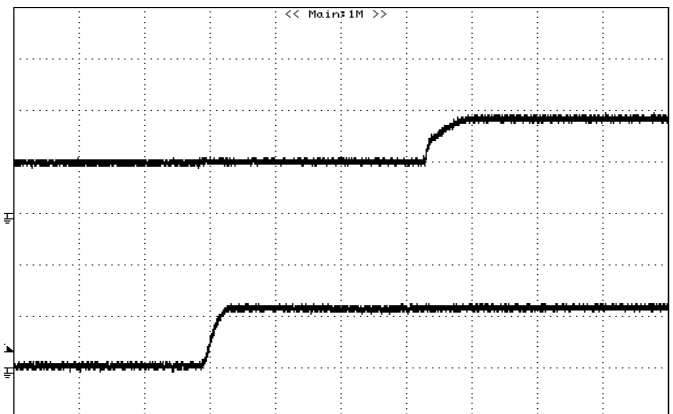
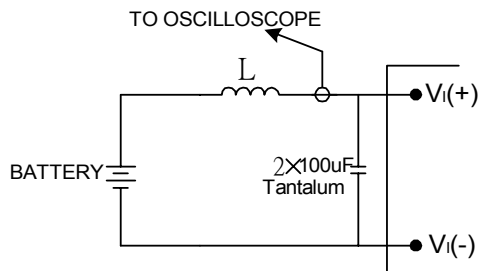

Figure 18: Turn on with Prebias 12Vin, 1.8V/0A out, Vbias = 1.0Vdc (5mS/div)
Top trace: Vout, 1V/div; Bottom trace: Vin, 10V/div

TEST CONFIGURATIONS



Note: Input reflected-ripple current is measured with a simulated source inductance. Current is measured at the input of the module.

Figure 19: Input reflected-ripple test setup

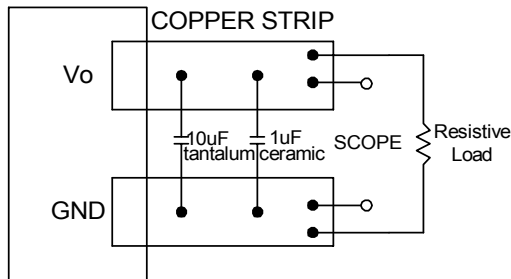

Note: Use a 10µF tantalum and 1µF capacitor. Scope measurement should be made using a BNC connector.

Figure 20: Peak-peak output noise and startup transient measurement test setup

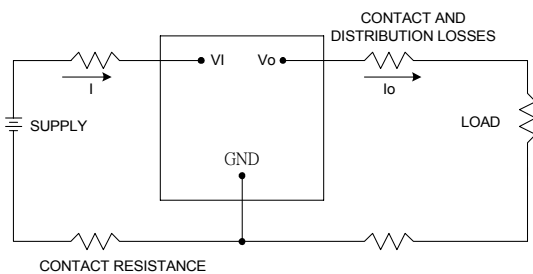

Figure 21: Output voltage and efficiency measurement test setup

Note: All measurements are taken at the module terminals. When the module is not soldered (via socket), place Kelvin connections at module terminals to avoid measurement errors due to contact resistance.

$$\eta = \left(\frac{V_o \times I_o}{V_i \times I_i} \right) \times 100 \quad \%$$

DESIGN CONSIDERATIONS

Input Source Impedance

To maintain low-noise and ripple at the input voltage, it is critical to use low ESR capacitors at the input to the module. The input capacitance should be able to handle an AC ripple current of at least:

$$I_{rms} = I_{out} \sqrt{\frac{V_{out}}{V_{in}} \left(1 - \frac{V_{out}}{V_{in}} \right)} \quad A_{rms}$$

The power module should be connected to a low ac-impedance input source. Highly inductive source impedances can affect the stability of the module. An input capacitance must be placed close to the modules input pins to filter ripple current and ensure module stability in the presence of inductive traces that supply the input voltage to the module.

Safety Considerations

For safety-agency approval the power module must be installed in compliance with the spacing and separation requirements of the end-use safety agency standards.

For the converter output to be considered meeting the requirements of safety extra-low voltage (SELV), the input must meet SELV requirements. The power module has extra-low voltage (ELV) outputs when all inputs are ELV.

The input to these units is to be provided with a maximum (TBD) A of glass type fast-acting fuse in the ungrounded lead.



FEATURES DESCRIPTIONS

Remote On/Off

The DNT series power modules have an On/Off pin for remote On/Off operation. Both positive and negative On/Off logic options are available in the DNT series power modules.

For positive logic module, connect an open collector (NPN) transistor or open drain (N channel) MOSFET between the On/Off pin and the GND pin (see figure 22). Positive logic On/Off signal turns the module ON during the logic high and turns the module OFF during the logic low. When the positive On/Off function is not used, leave the pin floating or tie to Vin (module will be On).

For negative logic module, the On/Off pin is pulled high with an external pull-up resistor (see figure 23) Negative logic On/Off signal turns the module OFF during logic high and turns the module ON during logic low. If the negative On/Off function is not used, leave the pin floating or tie to GND. (module will be On)

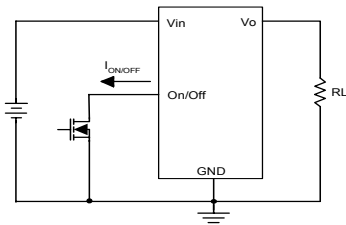

Figure 22: Positive remote On/Off implementation

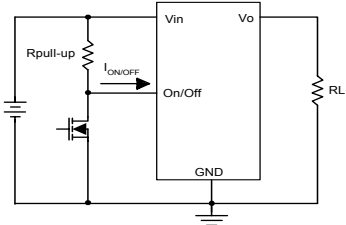

Figure 23: Negative remote On/Off implementation

Over-Current Protection

To provide protection in an output over load fault condition, the unit is equipped with internal over-current protection. When the over-current protection is triggered, the unit enters hiccup mode. The units operate normally once the fault condition is removed.

FEATURES DESCRIPTIONS (CON.)

Output Voltage Programming

The output voltage of the DNT can be programmed to any voltage between 0.75Vdc and 5.5Vdc by connecting one resistor (shown as Rtrim in Figure 25) between the TRIM and GND pins of the module. Without this external resistor, the output voltage of the module is 0.7525 Vdc. To calculate the value of the resistor Rtrim for a particular output voltage Vo, please use the following equation:

$$R_{trim} := \left(\frac{10500}{V_o - 0.7525} - 1000 \right) \cdot \Omega$$

Rtrim is the external resistor in Ω

Vo is the desired output voltage

For example, to program the output voltage of the DNT module to 3.3Vdc, Rtrim is calculated as follows:

$$R_{trim} := \left(\frac{10500}{2.5475} - 1000 \right) \cdot \Omega$$

$$R_{trim} = 3.122 \text{ k}\Omega$$

DNT can also be programmed by applying a voltage between the TRIM and GND pins (Figure 26). The following equation can be used to determine the value of Vtrim needed for a desired output voltage Vo:

$$V_{trim} := 0.7 - [(V_o - 0.7525) \cdot 0.0667]$$

Vtrim is the external voltage in V

Vo is the desired output voltage

For example, to program the output voltage of a DNT module to 3.3 Vdc, Vtrim is calculated as follows

$$V_{trim} := 0.7 - (2.5475 \cdot 0.0667)$$

FEATURE DESCRIPTIONS (CON.)

$$V_{trim} = 0.530V$$

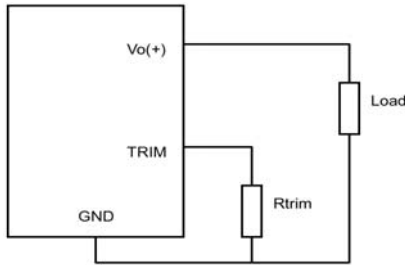

Figure 24: Circuit configuration for programming output voltage using an external resistor

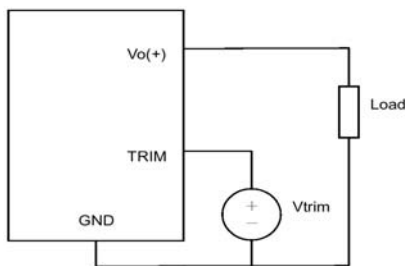

Figure 25: Circuit Configuration for programming output voltage using external voltage source

Table 1 provides R_{trim} values required for some common output voltages, while Table 2 provides value of external voltage source, V_{trim} , for the same common output voltages. By using a 1% tolerance trim resistor, set point tolerance of $\pm 2\%$ can be achieved as specified in the electrical specification.

Table 1

| VO (V) | Rtrim (KΩ) |
|--------|------------|
| 0.7525 | Open |
| 1.2 | 22.464 |
| 1.5 | 13.047 |
| 1.8 | 9.024 |
| 2.5 | 5.009 |
| 3.3 | 3.122 |
| 5.0 | 1.472 |
| 5.5 | 1.210 |

Table 2

| VO (V) | Vtrim (V) |
|--------|-----------|
| 0.7525 | Open |
| 1.2 | 0.670 |
| 1.5 | 0.650 |
| 1.8 | 0.630 |
| 2.5 | 0.583 |
| 3.3 | 0.530 |
| 5.0 | 0.4167 |
| 5.5 | 0.3840 |

FEATURE DESCRIPTIONS (CON.)

The amount of power delivered by the module is the voltage at the output terminals multiplied by the output current. When using the trim feature, the output voltage of the module can be increased, which at the same output current would increase the power output of the module. Care should be taken to ensure that the maximum output power of the module must not exceed the maximum rated power ($V_{o.set} \times I_{o.max} \leq P_{max}$).

Voltage Margining

Output voltage margining can be implemented in the DNT modules by connecting a resistor, $R_{margin-up}$, from the Trim pin to the ground pin for margining-up the output voltage and by connecting a resistor, $R_{margin-down}$, from the Trim pin to the output pin for margining-down. Figure 26 shows the circuit configuration for output voltage margining. If unused, leave the trim pin unconnected. A calculation tool is available from the evaluation procedure, which computes the values of $R_{margin-up}$ and $R_{margin-down}$ for a specific output voltage and margin percentage.

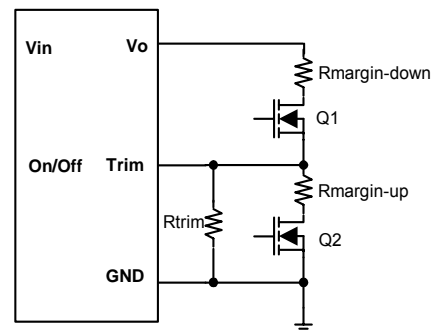

Figure 26: Circuit configuration for output voltage margining



THERMAL CONSIDERATIONS

Thermal management is an important part of the system design. To ensure proper, reliable operation, sufficient cooling of the power module is needed over the entire temperature range of the module. Convection cooling is usually the dominant mode of heat transfer.

Hence, the choice of equipment to characterize the thermal performance of the power module is a wind tunnel.

Thermal Testing Setup

Delta's DC/DC power modules are characterized in heated vertical wind tunnels that simulate the thermal environments encountered in most electronics equipment. This type of equipment commonly uses vertically mounted circuit cards in cabinet racks in which the power modules are mounted.

The following figure shows the wind tunnel characterization setup. The power module is mounted on a test PWB and is vertically positioned within the wind tunnel. The height of this fan duct is constantly kept at 25.4mm (1").

Thermal Derating

Heat can be removed by increasing airflow over the module. To enhance system reliability, the power module should always be operated below the maximum operating temperature. If the temperature exceeds the maximum module temperature, reliability of the unit may be affected.

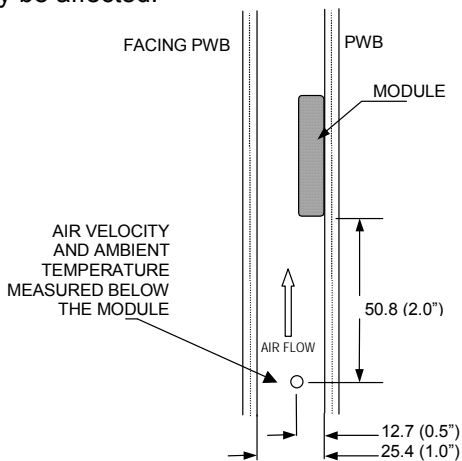

Note: Wind Tunnel Test Setup Figure Dimensions are in millimeters and (Inches)

Figure 27: Wind tunnel test setup

THERMAL CURVES

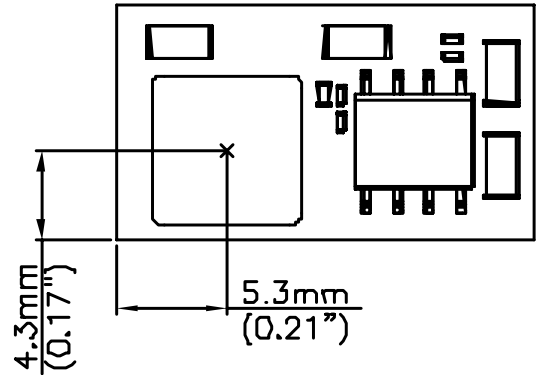

Figure 28: Temperature measurement location
The allowed maximum hot spot temperature is defined at 125°C.

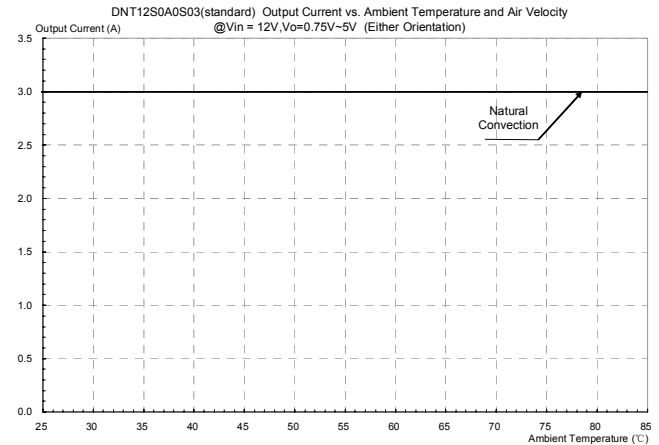
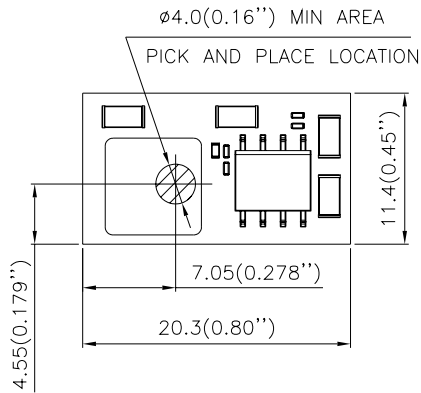

Figure 29: Output current vs. ambient temperature and air velocity @ Vin=12V, Vo=0.75V ~5.0V (Either Orientation)

PICK AND PLACE LOCATION



NOTES:
 ALL DIMENSIONS ARE IN MILLIMETERS AND (INCHES)
 TOLERANCES: X.Xmm±0.5mm(X.XX in.±0.02 in.)
 X.XXmm±0.25mm(X.XXX in.±0.010 in.)

SURFACE-MOUNT TAPE & REEL

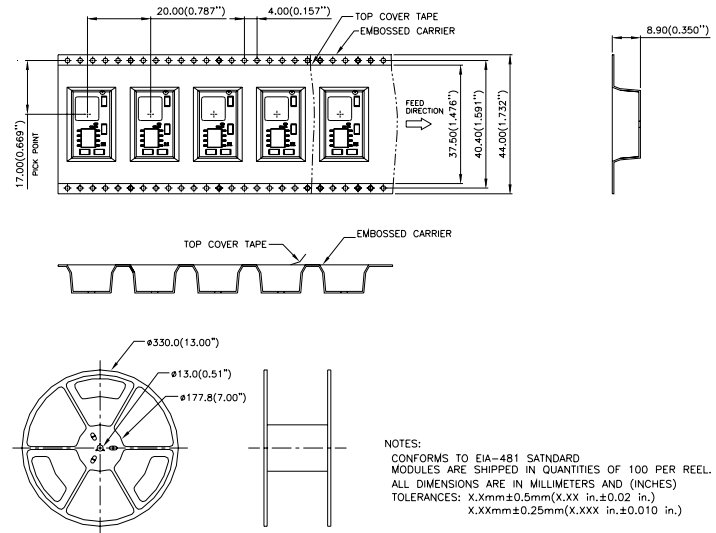

NOTES:
 CONFORMS TO EIA-481 STANDARD
 MODULES ARE SHIPPED IN QUANTITIES OF 100 PER REEL.
 ALL DIMENSIONS ARE IN MILLIMETERS AND (INCHES)
 TOLERANCES: X.Xmm±0.5mm(X.XX in.±0.02 in.)
 X.XXmm±0.25mm(X.XXX in.±0.010 in.)

LEAD (Sn/Pb) PROCESS RECOMMEND TEMP. PROFILE

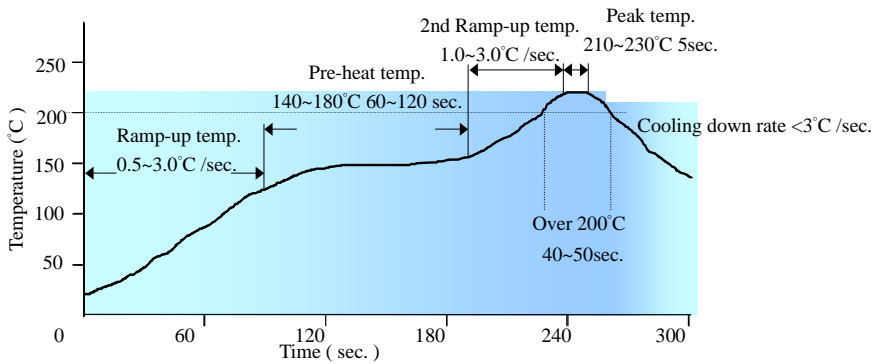

LEAD FREE (SAC) PROCESS RECOMMEND TEMP. PROFILE

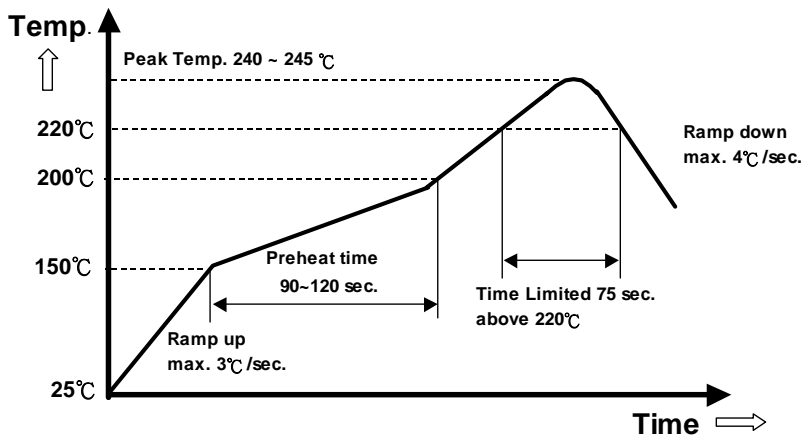

MECHANICAL DRAWING

SMD PACKAGE

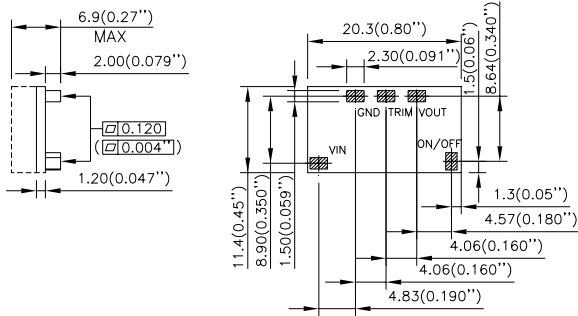

SIDE VIEW

BOTTOM VIEW

SIP PACKAGE (OPTIONAL)

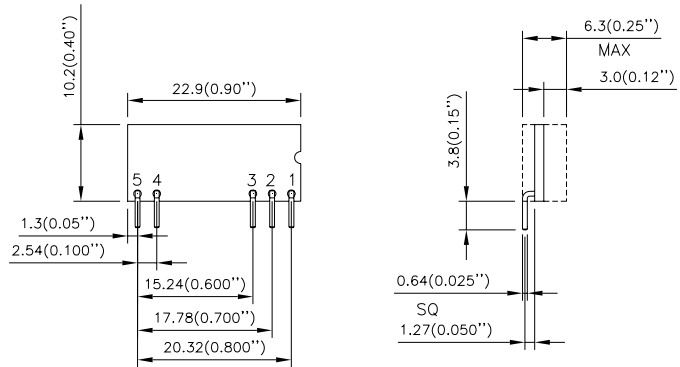

BACK VIEW

SIDE VIEW

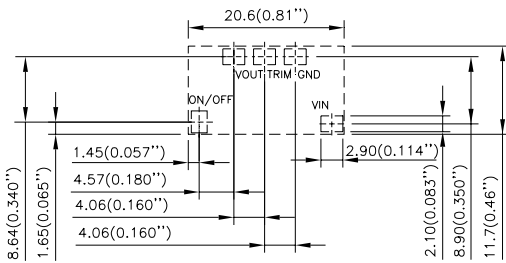

RECOMMAND PWB PAD LAYOUT

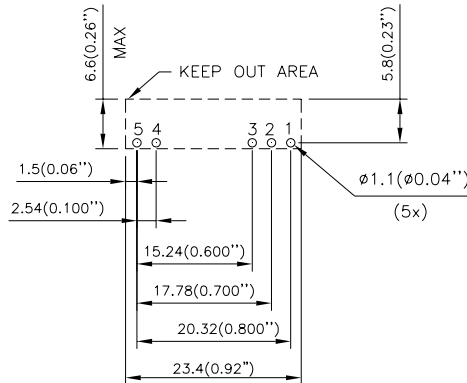

RECOMMAND PWB PAD LAYOUT

| PIN# | FUNCTION |
|------|----------|
| 1 | Vout |
| 2 | TRIM |
| 3 | GND |
| 4 | Vin |
| 5 | On/Off |

NOTES:

DIMENSIONS ARE IN MILLIMETERS AND (INCHES)

TOLERANCES: X.Xmm \pm 0.5mm(X.XX in. \pm 0.02 in.)

X.XXmm \pm 0.25mm(X.XXX in. \pm 0.010 in.)

PART NUMBERING SYSTEM

| | | | | | | | | |
|-----------------------|-------------------------------------|---------------------------|-----------------------|---------------------|-----------------------|----------------------------|-------------------------|------------------------|
| DNT | 12 | S | 0A0 | S | 03 | N | F | A |
| Product Series | Input Voltage | Numbers of Outputs | Output Voltage | Package Type | Output Current | On/Off logic | | Option Code |
| DNT - 3A or 5A | 04 - 2.4V ~ 5.5V 12 - 8.3V ~ 14V | S - Single | 0A0 - Programmable | R - SIP S - SMD | 03 - 3A 05 - 5A | N- Negative P- Positive | F- RoHS 6/6 (Lead Free) | A - Standard Functions |

MODEL LIST

| Model Name | Package | Input Voltage | Output Voltage | Output Current | Efficiency 12Vin, 5Vout full load |
|-----------------|---------|---------------|----------------|----------------|--------------------------------------|
| DNT12S0A0S03NFA | SMD | 8.3V ~ 14Vdc | 0.75V ~ 5.5Vdc | 3A | 93.0% |
| DNT12S0A0R03NFA | SIP | 8.3V ~ 14Vdc | 0.75V ~ 5.5Vdc | 3A | 92.5% |
| DNT12S0A0S05NFA | SMD | 8.3V ~ 14Vdc | 0.75V ~ 5.5Vdc | 5A | 92.0% |
| DNT12S0A0R05NFA | SIP | 8.3V ~ 14Vdc | 0.75V ~ 5.5Vdc | 5A | 91.0% |

CONTACT: www.delta.com.tw/dcdc

USA:

Telephone:
East Coast: (888) 335 8201
West Coast: (888) 335 8208
Fax: (978) 656 3964
Email: DCDC@delta-corp.com

Europe:

Phone: +41 31 998 53 11
Fax: +41 31 998 53 53
Email: DCDC@delta-es.com

Asia & the rest of world:

Telephone: +886 3 4526107 ext 6220
Fax: +886 3 4513485
Email: DCDC@delta.com.tw

WARRANTY

Delta offers a two (2) year limited warranty. Complete warranty information is listed on our web site or is available upon request from Delta.

Information furnished by Delta is believed to be accurate and reliable. However, no responsibility is assumed by Delta for its use, nor for any infringements of patents or other rights of third parties, which may result from its use. No license is granted by implication or otherwise under