

Ceramic Capacitors

Low ESL Feed Through SMD

CKD Series

FEATURES

- These small low-cost filters are used for meeting EMC requirements.
- Can be used up to even higher frequencies due to low parasitic inductance.
- Optimized for use as a noise bypass capacitors for signal and power source circuits.

APPLICATIONS

For digital and analog signal line noise bypassing signal line

PRODUCT IDENTIFICATION

CKD 510 X5R 1E 220 S □
(1) (2) (3) (4) (5) (6) (7)

(1) Series name

(2) Dimensions

110	3.2×1.25×0.85mm
310	3.2×1.6×1.6mm
510	2.0×1.25×0.85mm

(3) Capacitance temperature characteristics

Temperature characteristics	Capacitance change	Temperature range
X5R	±15%	-55 to +85°C

(4) Rated voltage E_{dc}

1A	10V
1C	16V
1E	25V
1H	50V

(5) Nominal capacitance

The capacitance is expressed in three digit codes and in units of pico farads (pF).

The first and second digits identify the first and second significant figures of the capacitance.

The third digit identifies the multiplier.

R designates a decimal point.

220	22pF
101	100pF
222	2200pF
473	47000pF

(6) Capacitance tolerance

S	+50, -20%
---	-----------

(7) Packaging style

T	Taping (reel)
B	Bulk



SHAPES AND DIMENSIONS/CIRCUIT DIAGRAM

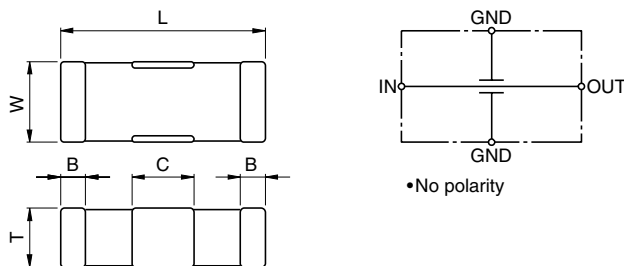

RECOMMENDED PC BOARD PATTERN (REFLOW)

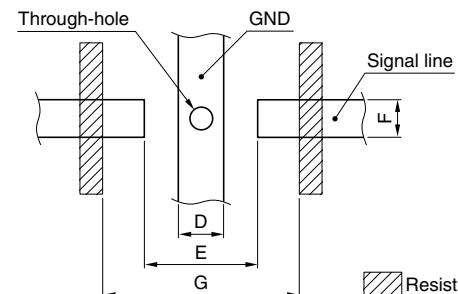

Dimensions in mm											
Application	Type	L	W	T	B	C	D	E	F	G	Weight(mg)
For Signal and Power Line	CKD510	2±0.2	1.25±0.2	0.85±0.15	0.2min.	0.5±0.2	0.6	1.5	1	2.6	11
For Power Line	CKD310	3.2±0.2	1.6±0.2	1.8max.	0.2min.	0.95±0.3	1.4	2.5	1	4.5	33
For Signal Line	CKD110	3.2±0.2	1.25±0.2	0.85±0.15	0.2min.	0.95±0.3	1.4	2.5	1	4.5	17

• For more information about products with other capacitance or other data, please contact us.

• All specifications are subject to change without notice.

Ceramic Capacitors

CKD Series

Low ESL Feed Through SMD

ELECTRICAL CHARACTERISTICS FOR SIGNAL LINE

CKD510 TYPE

RATED VOLTAGE E_{dc}: 50V

Capacitance (pF)	Tolerance (%)	Rated current I _{dc} (mA)max.	Insulation resistance (MΩ)min.	DC resistance* (Ω)max.	Part No.
22	+50, -20	400	1000	0.5	CKD510X5R1H220S
47	+50, -20	400	1000	0.5	CKD510X5R1H470S
100	+50, -20	400	1000	0.5	CKD510X5R1H101S
220	+50, -20	400	1000	0.5	CKD510X5R1H221S
470	+50, -20	400	1000	0.5	CKD510X5R1H471S
1000	+50, -20	400	1000	0.5	CKD510X5R1H102S
2200	+50, -20	400	1000	0.5	CKD510X5R1H222S
4700	+50, -20	400	1000	0.5	CKD510X5R1H472S

* DC resistance value is between feed-through terminals.

CKD110 TYPE

RATED VOLTAGE E_{dc}: 25V

Capacitance (pF)	Tolerance (%)	Rated current I _{dc} (mA)max.	Insulation resistance (MΩ)min.	DC resistance* (Ω)max.	Part No.
22	+50, -20	200	1000	0.6	CKD110X5R1E220S
47	+50, -20	200	1000	0.6	CKD110X5R1E470S
100	+50, -20	200	1000	0.6	CKD110X5R1E101S
220	+50, -20	200	1000	0.6	CKD110X5R1E221S
470	+50, -20	200	1000	0.6	CKD110X5R1E471S
1000	+50, -20	200	1000	0.6	CKD110X5R1E102S
2200	+50, -20	200	1000	0.6	CKD110X5R1E222S
4700	+50, -20	200	1000	0.6	CKD110X5R1E472S
10000	+50, -20	500	1000	0.3	CKD110X5R1E103S
22000	+50, -20	500	1000	0.3	CKD110X5R1E223S
47000	+50, -20	500	1000	0.3	CKD110X5R1E473S
100000	+50, -20	500	1000	0.3	CKD110X5R1E104S

* DC resistance value is between feed-through terminals.

FOR POWER LINE

CKD510 TYPE

RATED VOLTAGE E_{dc}: 25V

Capacitance (pF)	Tolerance (%)	Rated current I _{dc} (mA)max.	Insulation resistance (MΩ)min.	DC resistance* (Ω)max.	Part No.
10000	+50, -20	1000	1000	0.08	CKD510X5R1E103S
22000	+50, -20	1000	1000	0.08	CKD510X5R1E223S
47000	+50, -20	1000	1000	0.08	CKD510X5R1E473S
100000	+50, -20	1000	1000	0.08	CKD510X5R1E104S

* DC resistance value is between feed-through terminals.

RATED VOLTAGE E_{dc}: 10V

Capacitance (pF)	Tolerance (%)	Rated current I _{dc} (mA)max.	Insulation resistance (MΩ)min.	DC resistance* (Ω)max.	Part No.
1000000[1μF]	+50, -20	1000	1000	0.08	CKD510X5R1A105S

* DC resistance value is between feed-through terminals.

CKD310 TYPE

RATED VOLTAGE E_{dc}: 16V

Capacitance (pF)	Tolerance (%)	Rated current I _{dc} (mA)max.	Insulation resistance (MΩ)min.	DC resistance* (Ω)max.	Part No.
100000	+50, -20	2000	100	0.04	CKD310X5R1C104S
220000	+50, -20	2000	100	0.04	CKD310X5R1C224S
470000	+50, -20	2000	100	0.04	CKD310X5R1C474S
1000000[1μF]	+50, -20	2000	100	0.04	CKD310X5R1C105S

* DC resistance value is between feed-through terminals.

• For more information about products with other capacitance or other data, please contact us.

• All specifications are subject to change without notice.

Ceramic Capacitors

CKD Series

Low ESL Feed Through SMD

TYPICAL ELECTRICAL CHARACTERISTICS ATTENUATION vs. FREQUENCY CHARACTERISTICS COMPARISON WITH EXISTING PRODUCTS

Excellent noise bypass effect is displayed in higher frequency range compared with ordinary chip capacitors.

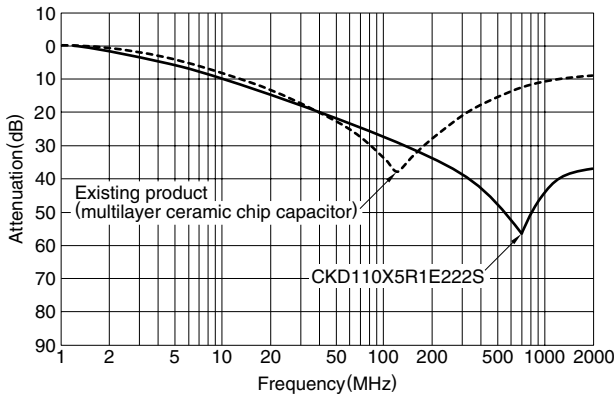

CKD110 TYPE

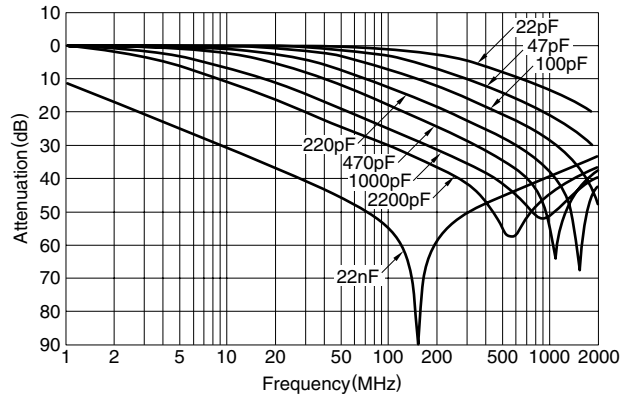

MEASURING CIRCUIT

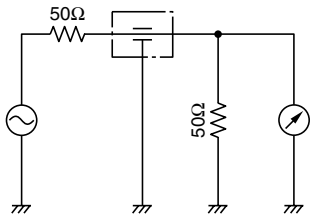

EXAMPLES OF NOISE COUNTERMEASURE

Purpose	1. Noise countermeasure on IC power supply lines: Eliminates noise occurring on supply lines to assure a stable voltage supply for proper IC operation.	2. Radiation noise countermeasure on signals lines: Attenuates superfluous high-frequency content of signals to prevent noise radiation.
---------	---	--

Type	CKD310 (High capacity type product)	CKD110, CKD510
------	--	----------------

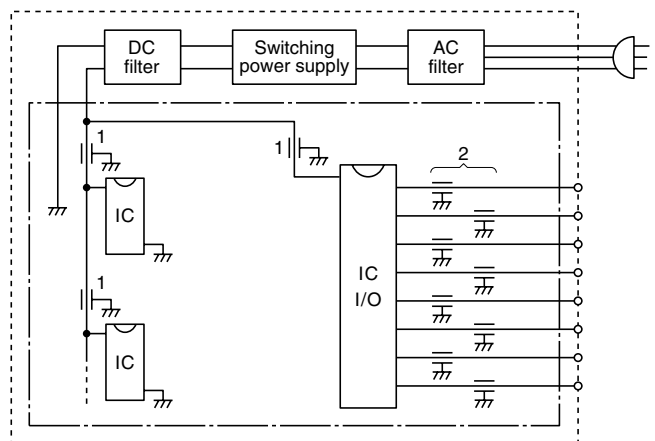

• For more information about products with other capacitance or other data, please contact us.

• All specifications are subject to change without notice.

Ceramic Capacitors

CKD Series

Low ESL Feed Through SMD

RELIABILITY AND TEST CONDITIONS

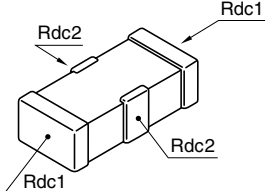
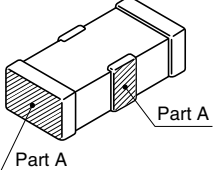
Item	Reliability	Test methods and test conditions																									
Exterior	No remarkable abnormal exterior appearance.	Micrometer (×3)																									
Insulation resistance	Minimum insulation resistance: 1000MΩ or 100MΩ • μF, whichever is smaller.	Measurement voltage: Rated voltage Voltage applied time: 60s																									
DC resistance (Rdc1, 2)	Less than 10000pF: 600mΩ max. 10000pF min.: 300mΩ max.	Measurement current: 100mA max.																									
																											
Withstand voltage	No dielectric nor mechanical damages.	Measurement voltage: 250% of rated DC voltage Voltage applied time: 1 to 5s Charge and discharge current: 50mA max.																									
Capacitance	Within specified tolerance	Measured frequency: 1kHz±10% Measured voltage Erms: 1±0.2V																									
Dielectric dissipation factor (tanδ)	Rated voltage 25V min. : 0.025 max. Rated voltage 16V max.: 0.05 max.	Measured frequency: 1kHz±10% Measured voltage Erms: 1±0.2V																									
Solderability	Cover more than 75% of the terminal electrode part with new solder. 25% of the part may have any pin hole or rough spot but they must not be concentrated in one location. Ceramic original surface indicated as A (hatched) must not be exposed due to any peeling or dissolving of the electrode part.	Solder: H63A (JIS Z 3282) Flux: Isopropyl alcohol solution (JIS K 8839) of Rosin (JIS K 5902) (25wt %) Solder temperature: 235±5°C Dipping: The terminal electrode must be immersed completely in solder. Dip time: 2±0.5s																									
																											
Temperature cycle*	<table border="1"> <tr> <td>Exterior</td> <td>No mechanical damages</td> </tr> <tr> <td>Capacitance</td> <td>Variance from previous test: ±7.5% max.</td> </tr> <tr> <td>tanδ</td> <td>Specified initial value must be satisfied.</td> </tr> <tr> <td>Insulation resistance</td> <td>Minimum insulation resistance: 500MΩ or 50MΩ•μF, whichever is smaller.</td> </tr> <tr> <td>DC resistance (Rdc1, 2)</td> <td>1Ω max.</td> </tr> </table>	Exterior	No mechanical damages	Capacitance	Variance from previous test: ±7.5% max.	tanδ	Specified initial value must be satisfied.	Insulation resistance	Minimum insulation resistance: 500MΩ or 50MΩ•μF, whichever is smaller.	DC resistance (Rdc1, 2)	1Ω max.	Leave the capacitor in each temperature of the following 1 to 4 steps for the specified time in order. Repeat this operation 5 times consecutively. Measure after leaving the sample at room temperature and humidity for 48±4h. <table border="1"> <thead> <tr> <th>Step</th> <th>Temperature (°C)</th> <th>Time (min)</th> </tr> </thead> <tbody> <tr> <td>1</td> <td>-25±3</td> <td>30±3</td> </tr> <tr> <td>2</td> <td>Room temperature</td> <td>2 to 5</td> </tr> <tr> <td>3</td> <td>+85±2</td> <td>30±3</td> </tr> <tr> <td>4</td> <td>Room temperature</td> <td>2 to 5</td> </tr> </tbody> </table>	Step	Temperature (°C)	Time (min)	1	-25±3	30±3	2	Room temperature	2 to 5	3	+85±2	30±3	4	Room temperature	2 to 5
Exterior	No mechanical damages																										
Capacitance	Variance from previous test: ±7.5% max.																										
tanδ	Specified initial value must be satisfied.																										
Insulation resistance	Minimum insulation resistance: 500MΩ or 50MΩ•μF, whichever is smaller.																										
DC resistance (Rdc1, 2)	1Ω max.																										
Step	Temperature (°C)	Time (min)																									
1	-25±3	30±3																									
2	Room temperature	2 to 5																									
3	+85±2	30±3																									
4	Room temperature	2 to 5																									
Humidity resistance* (Normal state)	<table border="1"> <tr> <td>Exterior</td> <td>No mechanical damage.</td> </tr> <tr> <td>Capacitance</td> <td>Variance from previous test: ±10% max.</td> </tr> <tr> <td>tanδ</td> <td>Max. 200% of specified initial value</td> </tr> <tr> <td>Insulation resistance</td> <td>Minimum insulation resistance: 500MΩ or 10MΩ•μF, whichever is smaller.</td> </tr> <tr> <td>DC resistance (Rdc1, 2)</td> <td>1Ω max.</td> </tr> </table>	Exterior	No mechanical damage.	Capacitance	Variance from previous test: ±10% max.	tanδ	Max. 200% of specified initial value	Insulation resistance	Minimum insulation resistance: 500MΩ or 10MΩ•μF, whichever is smaller.	DC resistance (Rdc1, 2)	1Ω max.	Relative humidity: 90 to 95(%)RH Temperature: 40±2°C Time: 500+24, -0h Measure after leaving the sample at room temperature and humidity for 48±4h.															
Exterior	No mechanical damage.																										
Capacitance	Variance from previous test: ±10% max.																										
tanδ	Max. 200% of specified initial value																										
Insulation resistance	Minimum insulation resistance: 500MΩ or 10MΩ•μF, whichever is smaller.																										
DC resistance (Rdc1, 2)	1Ω max.																										
High temperature resistance	<table border="1"> <tr> <td>Exterior</td> <td>No mechanical damage</td> </tr> <tr> <td>Capacitance</td> <td>Variance from previous test: ±12.5% max.</td> </tr> <tr> <td>tanδ</td> <td>Max. 200% of specified initial value</td> </tr> <tr> <td>Insulation resistance</td> <td>Minimum insulation resistance: 500MΩ or 50MΩ•μF, whichever is smaller.</td> </tr> <tr> <td>DC resistance (Rdc1, 2)</td> <td>1Ω max.</td> </tr> </table>	Exterior	No mechanical damage	Capacitance	Variance from previous test: ±12.5% max.	tanδ	Max. 200% of specified initial value	Insulation resistance	Minimum insulation resistance: 500MΩ or 50MΩ•μF, whichever is smaller.	DC resistance (Rdc1, 2)	1Ω max.	Temperature: 85±2°C Voltage: 200% of rated DC voltage Current: Rated current Time: 1000+48, -0h Charge and discharge current: 50mA max. Measure after leaving the sample at room temperature and humidity of 48±4h. Voltage processing: Capacitor shall be tested at a specified temperature under a specified voltage for 1h and the initial value shall be measured after setting the sample at room temperature for 48±4h.															
Exterior	No mechanical damage																										
Capacitance	Variance from previous test: ±12.5% max.																										
tanδ	Max. 200% of specified initial value																										
Insulation resistance	Minimum insulation resistance: 500MΩ or 50MΩ•μF, whichever is smaller.																										
DC resistance (Rdc1, 2)	1Ω max.																										

* Capacitors shall be tested at 150+0, -10°C for 1 hour and the initial value shall be measured after setting the sample at room temperature and humidity for 48±4 hours.

• For more information about products with other capacitance or other data, please contact us.

• All specifications are subject to change without notice.