

PLEASE CHECK WWW.MOLEX.COM FOR LATEST PART INFORMATION

Part Number: [0879833144](#)
Status: **Active**
Overview: milligrd
Description: 2.00mm (.079") Pitch Milli-Grid™ Header, Surface Mount, Vertical, Shrouded, Lead-free, 44 Circuits, 0.38µm (15µ") Gold (Au) Plating, Center Polarization Slot, Cap, without PCB Locator, Metal Latch, Tube

Documents:

[3D Model](#)
[Drawing \(PDF\)](#)

[RoHS Certificate of Compliance \(PDF\)](#)

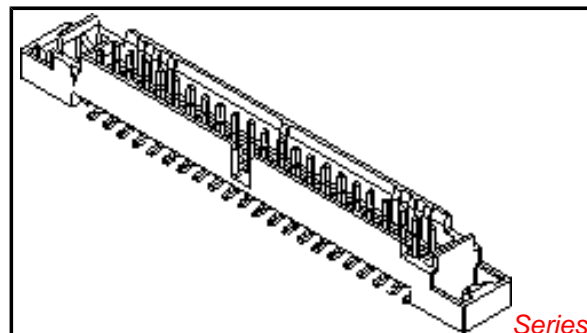

image - Reference only

Series

General

Product Family	PCB Headers
Series	87983
Application	Wire-to-Board
Comments	Contact Molex for application in automotive industry
Overview	milligrd
Product Name	Milli-Grid™

Physical

Breakaway	No
Circuits (Loaded)	44
Circuits (maximum)	44
Color - Resin	Black
Durability (mating cycles max)	30
First Mate / Last Break	No
Glow-Wire Compliant	No
Guide to Mating Part	No
Keying to Mating Part	None
Lock to Mating Part	Yes
Material - Plating Mating	Gold
Material - Plating Termination	Tin
Material - Resin	High Temperature Thermoplastic
Number of Rows	2
Orientation	Vertical
PCB Locator	No
PCB Retention	None
Packaging Type	Tube
Pitch - Mating Interface (in)	0.079 In
Pitch - Mating Interface (mm)	2.00 mm
Plating min: Mating (µin)	15.2
Plating min: Mating (µm)	0.38
Plating min: Termination (µin)	76.4
Plating min: Termination (µm)	1.91
Polarized to Mating Part	Center Slot
Polarized to PCB	Yes
Robotic Placement	Pick and Place Cap
Shrouded	Fully
Stackable	No
Temperature Range - Operating	-40°C to +85°C
Termination Interface: Style	Surface Mount

Electrical

Current - Maximum per Contact	2A
Voltage - Maximum	125V

EU RoHS

**ELV and RoHS
Compliant**
**REACH SVHC
Contains SVHC: No**
**Halogen-Free
Status**

China RoHS



Not Halogen-Free

**Need more information on product
environmental compliance?**

Email productcompliance@molex.com
For a multiple part number RoHS Certificate of Compliance, [click here](#)

Please visit the [Contact Us](#) section for any non-product compliance questions.

Search Parts in this Series

[87983Series](#)

Mates With

[87985 Milli-Grid™ Receptacle](#)

Solder Process Data

Duration at Max. Process Temperature (seconds)	10
Lead-free Process Capability	Reflow Capable (SMT only)
Max. Cycles at Max. Process Temperature	1
Process Temperature max. C	260

Material Info**Reference - Drawing Numbers**

Sales Drawing	SD-87983-007
---------------	--------------

This document was generated on 05/26/2010

PLEASE CHECK WWW.MOLEX.COM FOR LATEST PART INFORMATION

10 9 8 7 6 5 4 3 2 1

ASSY P/N PACKED IN TAPE & REEL	ASSY P/N PACKED IN TUBE	CKT SIZE	DIMENSION					
			A	B	C	D	E	F
87983-3044	87983-3144	44	59.00	42.00	50.65	45.00	44.85	42.50

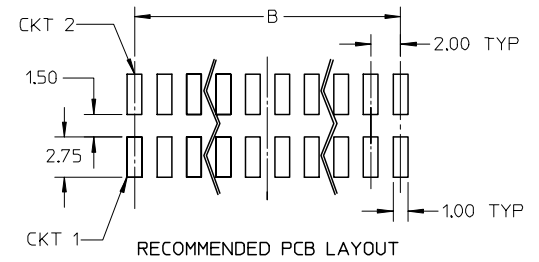
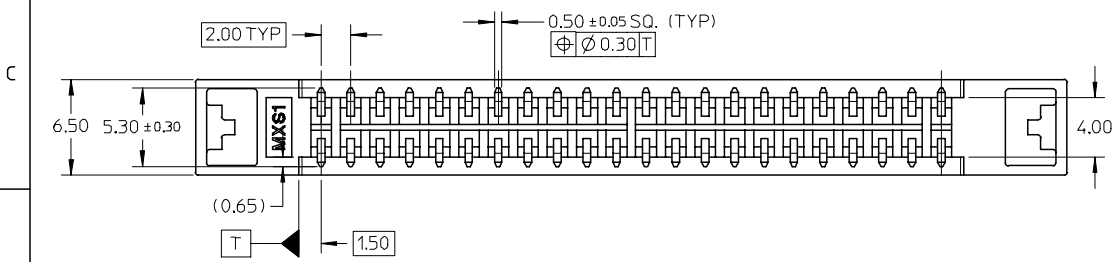
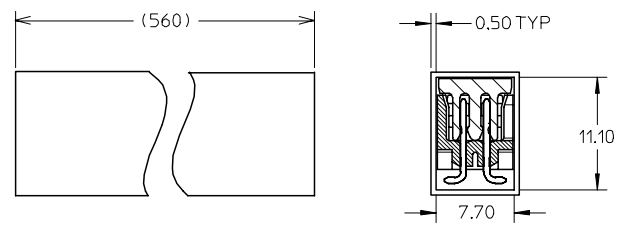
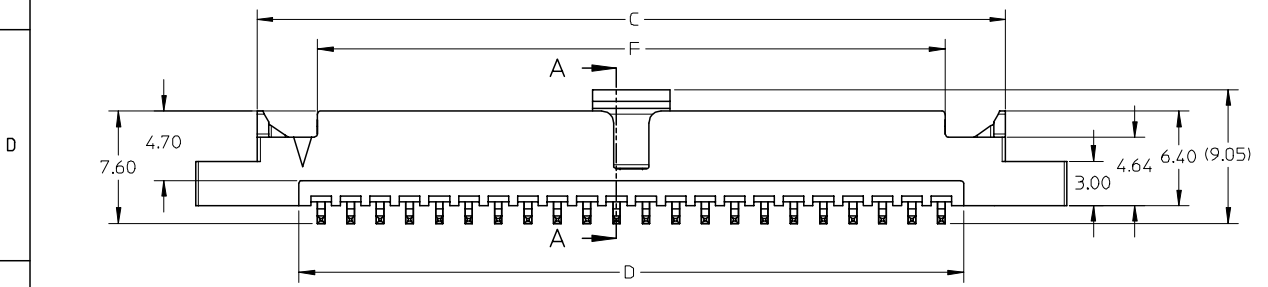
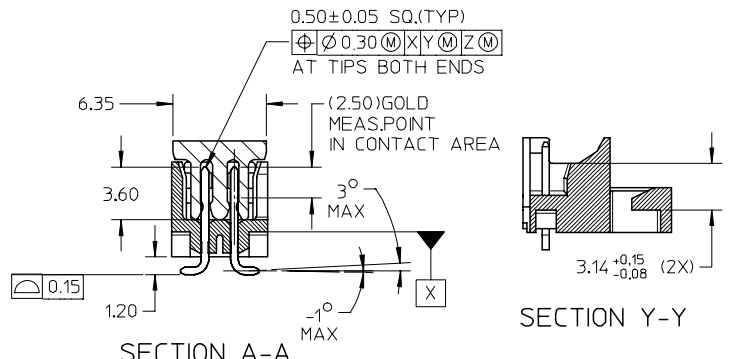
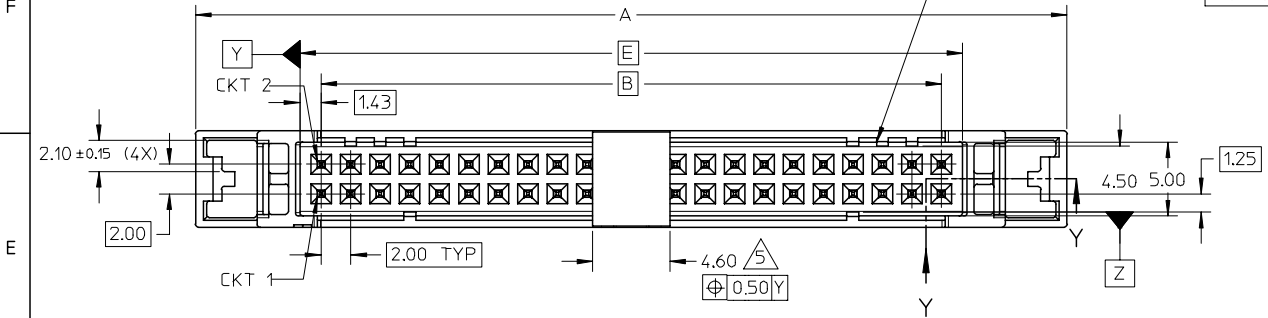

- NOTES:
- MATERIAL :
HOUSING : PA, GLASS FILLED, UL94V-0, COLOR BLACK.
PIN : PHOSPHOR BRONZE.
 - PLATING: 0.38µM GOLD IN CONTACT AREA AND 1.88µM MIN. TIN IN SOLDER TAIL AREA OVER 1.27µM MIN. NICKEL OVERALL.
 - FOR ILLUSTRATION PURPOSES, 44 CIRCUIT SIZE WAFER IS SHOWN.
 - THIS IS A LEAD-FREE PRODUCT.
 - POSITION OF CAP TO BE LOCATED AT CENTER OF DIMENSION 'A' REGARDLESS OF CIRCUIT SIZE.
 - PRODUCT SPECIFICATION : PS-87981-018
 - PRODUCTS ARE MATED WITH 87985 SERIES.

ADD PART NUMBER EC NO: S2007-0266 DRWN:SKANG CHKD:MLONG APPR:SKTOH 2006/10/05 2006/10/09 2006/10/09	DESCRIPTION REV	QUALITY SYMBOLS ▽=0 ∇=0	GENERAL TOLERANCES (UNLESS SPECIFIED)		DIMENSION STYLE MM ONLY		SCALE NTS	DESIGN UNITS METRIC	THIRD ANGLE PROJECTION
			mm	INCH	DRAWN BY YLQIAO	DATE 2005/06/30	TITLE MGRID, SHROUDED HEADER W/EMBOSSED M/LATCH SLOT SMT	MOLEX INCORPORATED	SHEET NO. 1 OF 2
A2	REV		DRAFT WHERE APPLICABLE MUST REMAIN WITHIN DIMENSIONS		SEE TABLE		DOCUMENT NO. SD-87983-007		
			THIS DRAWING CONTAINS INFORMATION THAT IS PROPRIETARY TO MOLEX INCORPORATED AND SHOULD NOT BE USED WITHOUT WRITTEN PERMISSION						

9 8 7 6 5 4 3 2 1

10 9 8 7 6 5 4 3 2 1

F
E
D
C
B
A

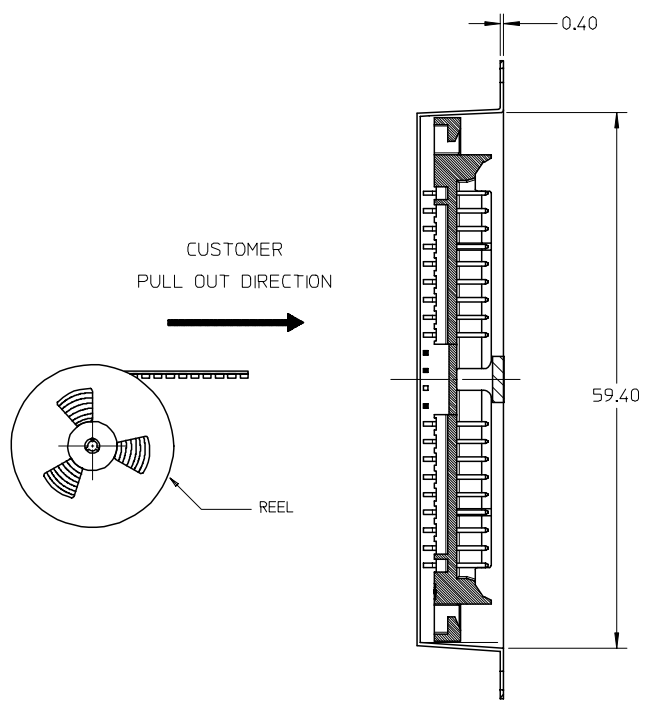

SECTION Z-Z

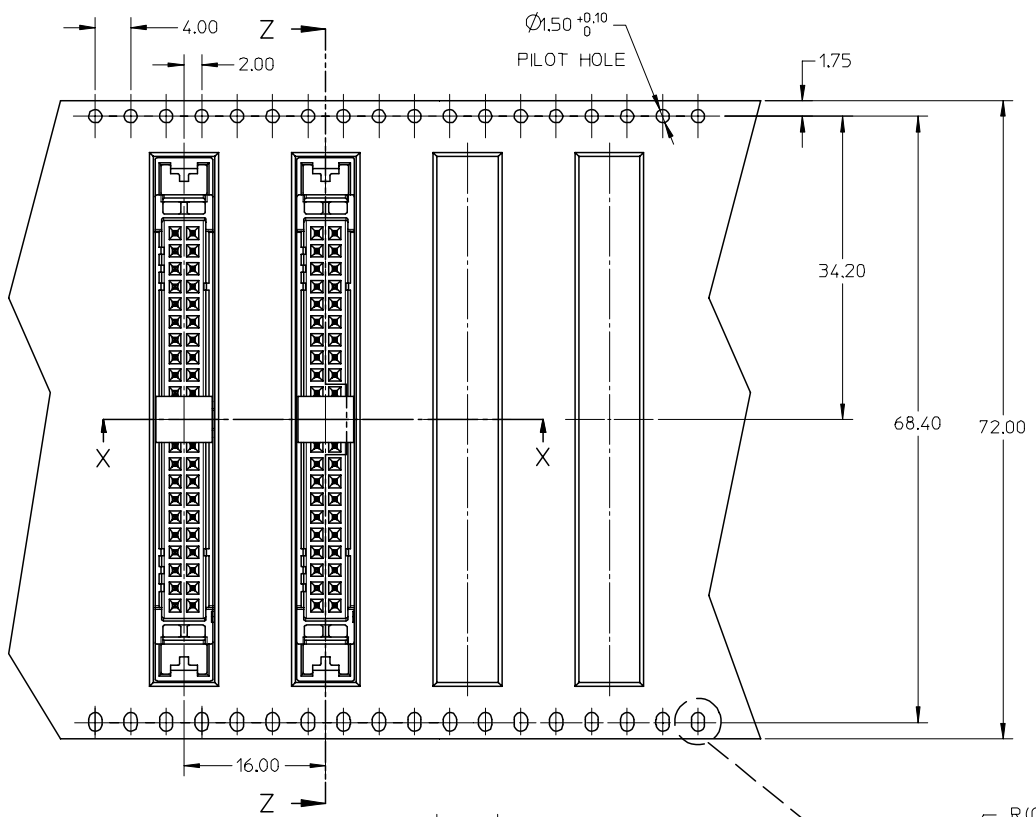

SECTION X-X

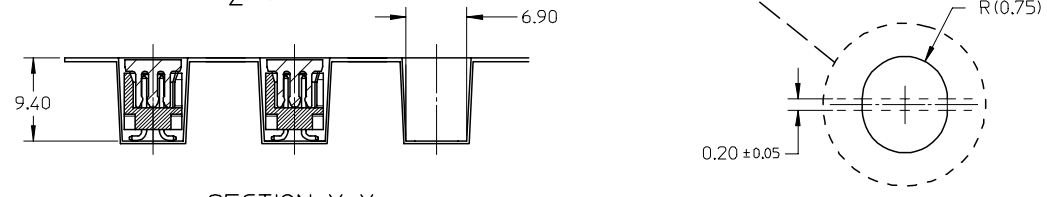

NOTES:

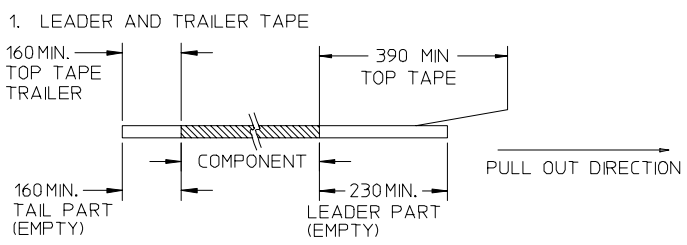

2. PEELING OFF FORCE OF THE TOP TAPE: 20-80gf.
(PEELING DIRECTION AS SHOWN IN FOLLOWING FIGURE)

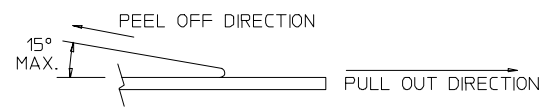

- 3. PACKAGING STANDARD IS AS PER EIA-481.
- 4. TAPE & REEL QUANTITY = 400 PCS/REEL
- 5. THE TAPE IS TREATED FOR ANTI-STATIC.

ADD PART NUMBER EC NO: S2007-0266 DRWNS:KANG CHKD:M/LONG APPR:SKTOH	2006/10/05 2006/10/09 2006/10/09	DESCRIPTION A2	QUALITY SYMBOLS ▽=0 ▽=0	GENERAL TOLERANCES (UNLESS SPECIFIED)		DIMENSION STYLE MM ONLY		SCALE NTS	DESIGN UNITS METRIC	THIRD ANGLE PROJECTION	
						DRAWN BY YLQ1A0	DATE 2005/06/30	TITLE MGRID, SHROUDED HEADER W/EMBOSSED M/LATCH SLOT SMT			
						CHECKED BY BOKOK	DATE 2005/07/13	APPROVED BY PTL IM			
						APPROVED BY DATE 2005/07/13		MATERIAL NO.		DOCUMENT NO. SD-87983-007	SHEET NO. 2 OF 2
DRAFT WHERE APPLICABLE MUST REMAIN WITHIN DIMENSIONS				SEE TABLE		MOLEX INCORPORATED					
THIS DRAWING CONTAINS INFORMATION THAT IS PROPRIETARY TO MOLEX INCORPORATED AND SHOULD NOT BE USED WITHOUT WRITTEN PERMISSION											

9 8 7 6 5 4 3 2 1