

*Phase leg  
Intelligent Power Module*

$V_{CES} = 600V$   
 $I_C = 350A @ T_c = 80^\circ C$

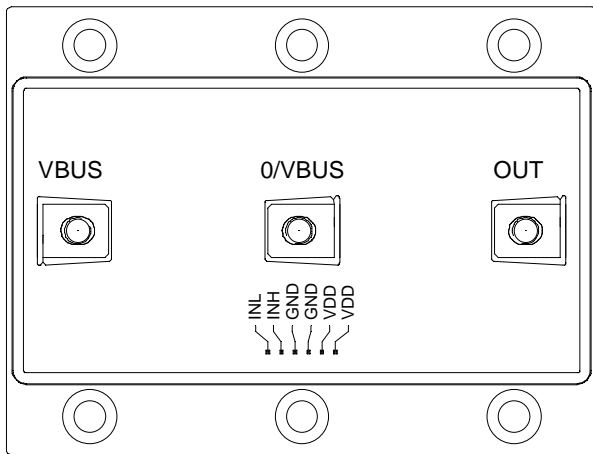
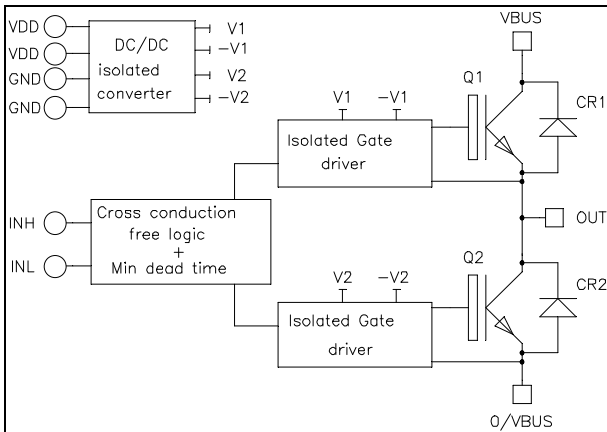

### Application

- Motor control
- Uninterruptible Power Supplies
- Switched Mode Power Supplies
- Amplifier

### Features

- **Non Punch Through (NPT) FAST IGBT**
  - Low voltage drop
  - Low tail current
  - Soft recovery parallel diodes
  - Low diode VF
  - Low leakage current
  - RBSOA & SCSOA rated
- **Integrated Fail Safe IGBT Protection (Driver)**
  - Top Bottom input signals Interlock
  - Isolated DC/DC Converter

- Low stray inductance
- M5 power connectors
- High level of integration

### Benefits

- Outstanding performance at high frequency operation
- Stable temperature behavior
- Very rugged
- Direct mounting to heatsink (isolated package)
- Low junction to case thermal resistance
- Very high noise immunity (common mode rejection > 25kV/μs)
- Galvanic Isolation: 3750V for the optocoupler  
2500V for the transformer
- 5V logic level with Schmitt-trigger Input
- Single  $V_{DD}=5V$  supply required
- Secondary auxiliary power supplies internally generated (15V, -6V)
- Optocoupler qualified to AEC-Q100 test guidelines
- RoHS compliant

 **CAUTION:** These Devices are sensitive to Electrostatic Discharge. Proper Handling Procedures Should Be Followed. See application note APT0502 on [www.microsemi.com](http://www.microsemi.com)

All ratings @  $T_j = 25^\circ\text{C}$  unless otherwise specified

### 1. Inverter Power Module

#### Absolute maximum ratings

Symbol	Parameter	Max ratings	Unit
$V_{CES}$	Collector - Emitter Breakdown Voltage	600	V
$I_C$	Continuous Collector Current	$T_C = 25^\circ\text{C}$	430
		$T_C = 80^\circ\text{C}$	350
$I_{CM}$	Pulsed Collector Current	$T_C = 25^\circ\text{C}$	700
$P_D$	Maximum Power Dissipation	$T_C = 25^\circ\text{C}$	1562
RBSOA	Reverse Bias Safe Operating Area	$T_j = 125^\circ\text{C}$	800A@550V

#### Electrical Characteristics

Symbol	Characteristic	Test Conditions	Min	Typ	Max	Unit
$I_{CES}$	Zero Gate Voltage Collector Current	$V_{GE} = 0\text{V}$ $V_{CE} = 600\text{V}$	$T_j = 25^\circ\text{C}$		0.5	mA
			$T_j = 125^\circ\text{C}$		1.5	
$V_{CE(sat)}$	Collector Emitter Saturation Voltage	$V_{DD} = V_{IN} = 5\text{V}$ $I_C = 400\text{A}$	$T_j = 25^\circ\text{C}$		2	V
			$T_j = 125^\circ\text{C}$		2.2	

#### Dynamic Characteristics

Symbol	Characteristic	Test Conditions	Min	Typ	Max	Unit
$C_{ies}$	Input Capacitance	$V_{GE} = 0\text{V}$ $V_{CE} = 25\text{V}$ $f = 1\text{MHz}$		17.2		nF
$C_{oes}$	Output Capacitance			1.88		
$C_{res}$	Reverse Transfer Capacitance			1.6		
$T_r$	Rise Time	Inductive Switching ( $25^\circ\text{C}$ ) $V_{DD} = V_{IN} = 5\text{V}$ $V_{Bus} = 400\text{V}; I_C = 400\text{A}$		25		ns
$T_f$	Fall Time			30		
$T_r$	Rise Time	Inductive Switching ( $125^\circ\text{C}$ ) $V_{DD} = V_{IN} = 5\text{V}$ $V_{Bus} = 400\text{V}$ $I_C = 400\text{A}$		25		ns
$T_f$	Fall Time			45		
$E_{on}$	Turn-on Switching Energy	$V_{DD} = V_{IN} = 5\text{V}; V_{Bus} = 360\text{V}$ $t_p \leq 10\mu\text{s}; T_j = 125^\circ\text{C}$		17.2		mJ
$E_{off}$	Turn-off Switching Energy			14		
$I_{sc}$	Short Circuit data			1800		A
$R_{thJC}$	Junction to Case thermal resistance				0.08	$^\circ\text{C}/\text{W}$

**Reverse diode ratings and characteristics**

Symbol	Characteristic	Test Conditions	Min	Typ	Max	Unit
V <sub>RRM</sub>	Maximum Peak Repetitive Reverse Voltage		600			V
I <sub>RM</sub>	Maximum Reverse Leakage Current	V <sub>R</sub> =600V	T <sub>j</sub> = 25°C		100	μA
			T <sub>j</sub> = 125°C		2000	
I <sub>F</sub>	DC Forward Current			240		A
V <sub>F</sub>	Diode Forward Voltage	I <sub>F</sub> = 240A		1.7	2.3	V
		I <sub>F</sub> = 480A		2		
		I <sub>F</sub> = 240A	T <sub>j</sub> = 125°C	1.4		
t <sub>rr</sub>	Reverse Recovery Time	I <sub>F</sub> = 240A V <sub>R</sub> = 400V	T <sub>j</sub> = 25°C	70		ns
	T <sub>j</sub> = 125°C		140			
Q <sub>rr</sub>	Reverse Recovery Charge	di/dt = 800A/μs	T <sub>j</sub> = 25°C	400		nC
			T <sub>j</sub> = 125°C	2760		
R <sub>thJC</sub>	Junction to Case Thermal Resistance				0.22	°C/W

**2. Driver**
**Absolute maximum ratings**

Symbol	Parameter	Max ratings	Unit
V <sub>DD</sub>	Supply Voltage	5.5	V
V <sub>INi</sub>	Input signal voltage i=L, H	5.5	
I <sub>VDDmax</sub>	Maximum Supply current	V <sub>INi</sub> = 0V, i=L & H	0.35
		V <sub>DD</sub> =5V, V <sub>INH</sub> = V <sub>INL</sub> ; F <sub>out</sub> = 60kHz	2
f <sub>max</sub>	Maximum Switching Frequency	60	kHz

**Driver Electrical Characteristics**

Symbol	Characteristic	Test Conditions	Min	Typ	Max	Unit
V <sub>DD</sub>	Operating Supply Voltage		4.5	5	5.5	V
V <sub>INi(max)</sub>	Maximum Input Voltage	i = L, H	-0.5	5	5.5	V
V <sub>INi(th+)</sub>	Positive Going Threshold Voltage			3.2		
V <sub>INi(th-)</sub>	Negative Going Threshold Voltage			1		
R <sub>INi</sub>	Input Resistance *			1		kΩ
T <sub>d(on)</sub>	Turn On delay time	Driver + IGBT		1100 <sup>①</sup>		ns
D <sub>T</sub>	Built in dead time			600		
T <sub>d(off)</sub>	Turn Off delay time	Driver + IGBT		750		ns
PWD	Pulse Width Distortion				300	
PDD	Propagation Delay Difference between any two driver	T <sub>d(on)</sub> - T <sub>d(off)</sub>	-350		350	ns
V <sub>ISOL</sub>	Primary to Secondary Isolation		2500			V <sub>RMS</sub>

\* Low impedance guarantees good noise immunity.

① Including built in dead time.

### 3. Package characteristics

Symbol	Characteristic	Min	Typ	Max	Unit	
V <sub>ISOL</sub>	RMS Isolation Voltage, any terminal to case t=1 min, I isol<1mA, 50/60Hz	2500			V	
T <sub>J</sub>	Operating junction temperature range	-40		150	°C	
T <sub>OP</sub>	Operating Ambient Temperature	-40		85		
T <sub>STG</sub>	Storage Temperature Range	-40		100		
T <sub>C</sub>	Operating Case Temperature	-40		100		
Torque	Mounting torque	To heatsink	M5	2	4.7	N.m
		For terminals	M5	2		
Wt	Package Weight		550		g	

### 4. LP8 Package outline (dimensions in mm)

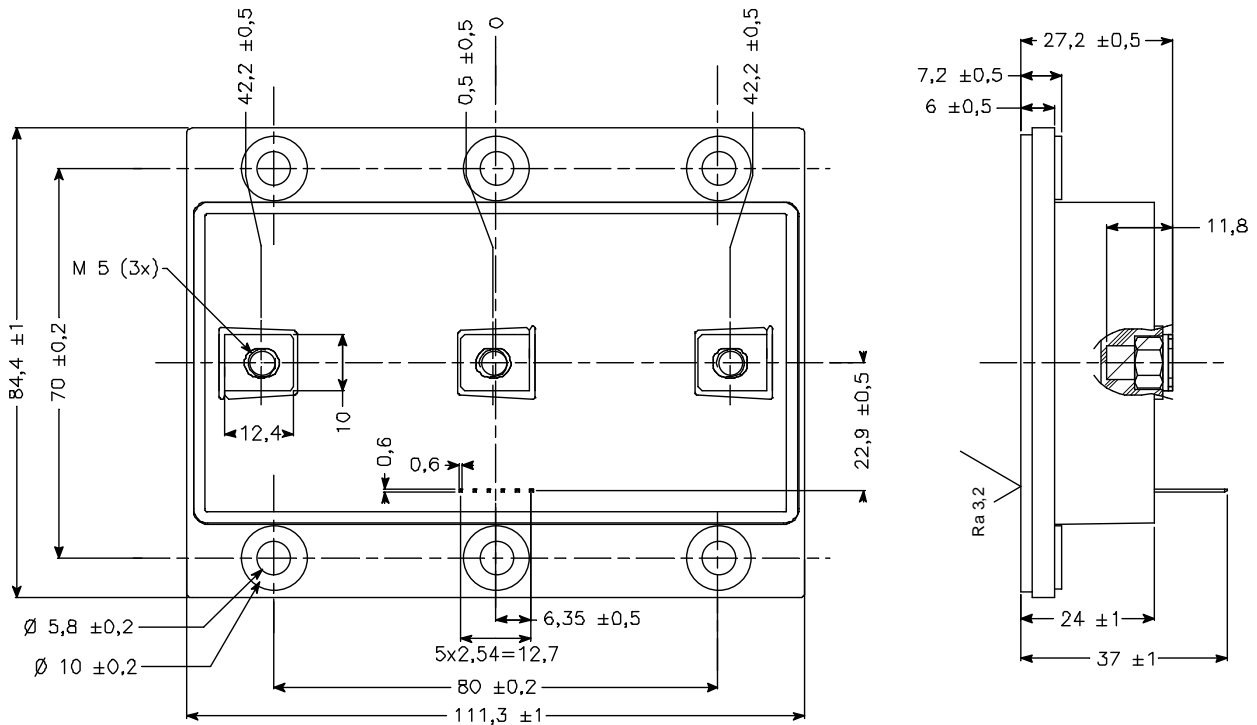

## Typical IGBT Performance Curve

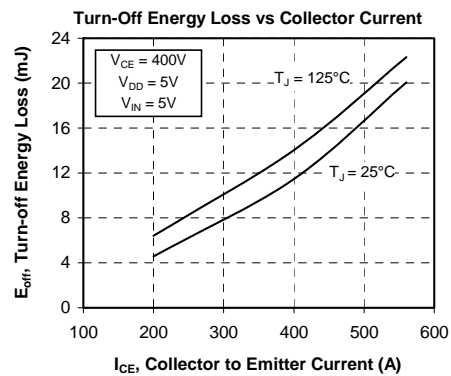
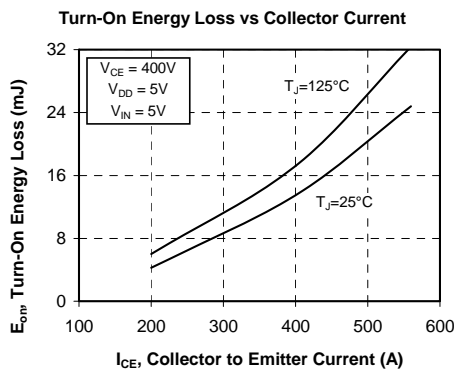
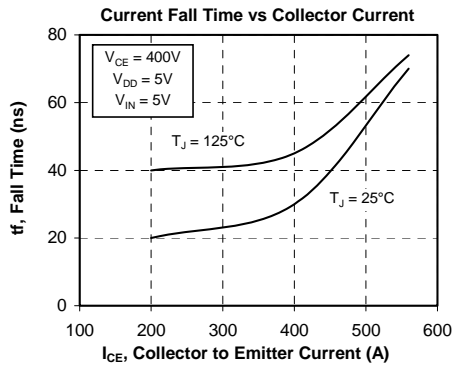
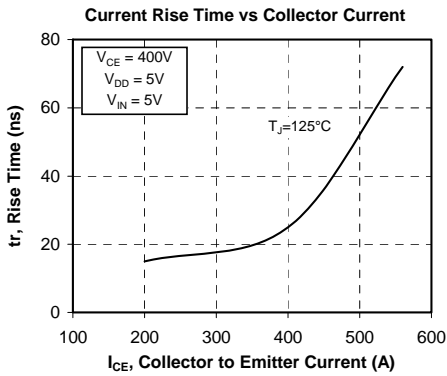
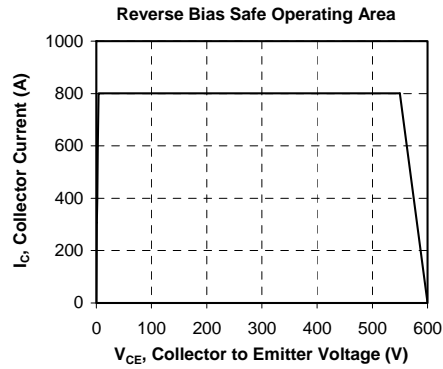
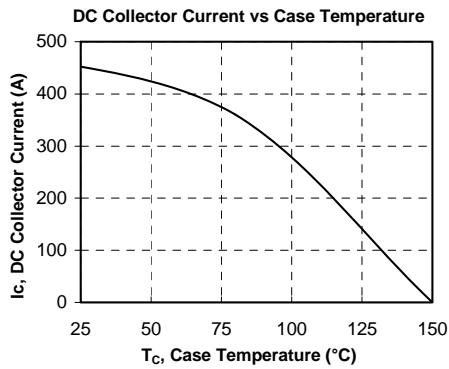
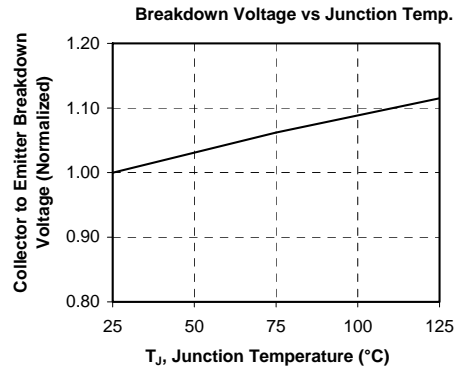
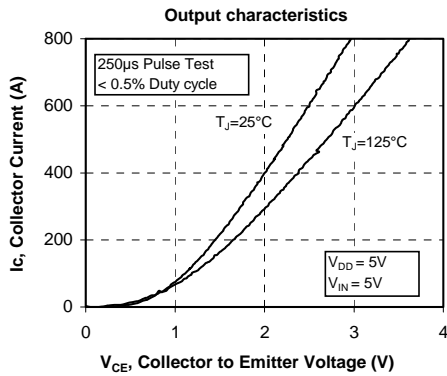

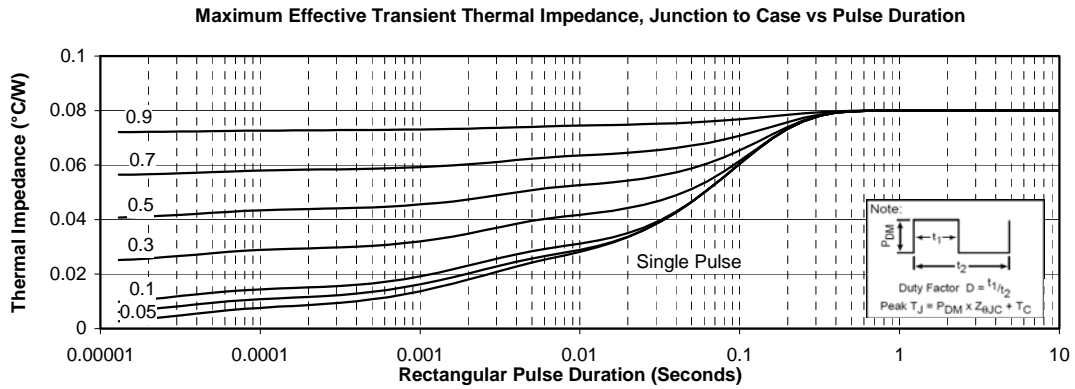
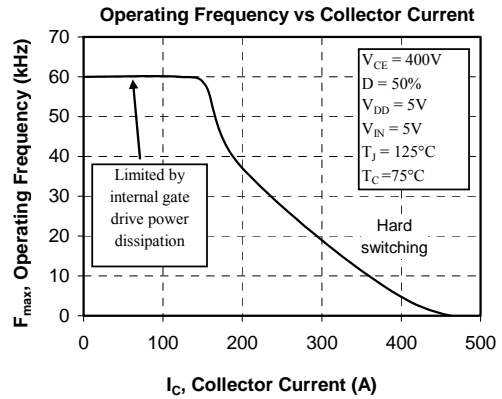
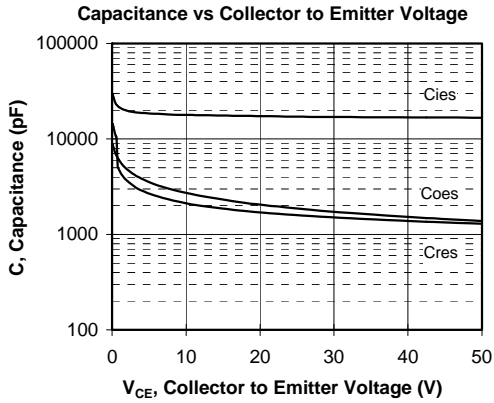

## Typical diode Performance Curve

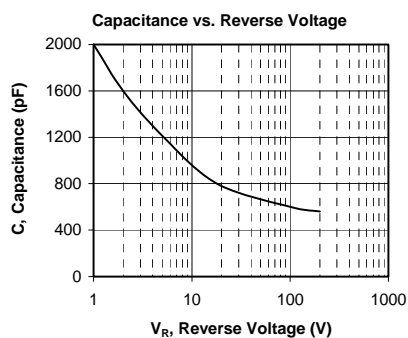
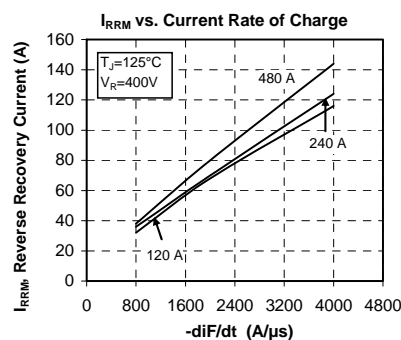
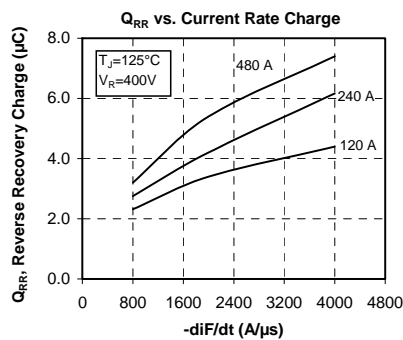
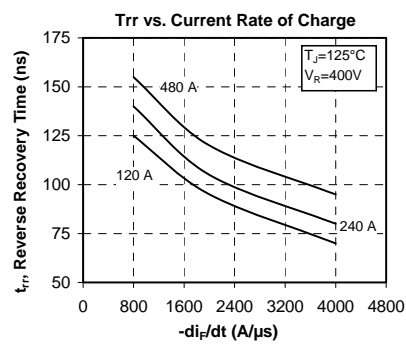
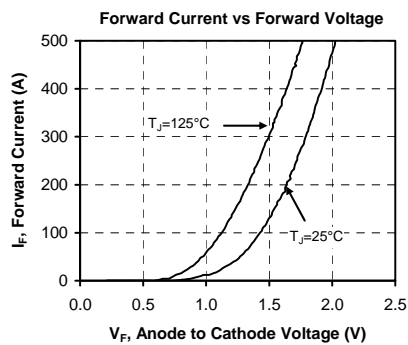
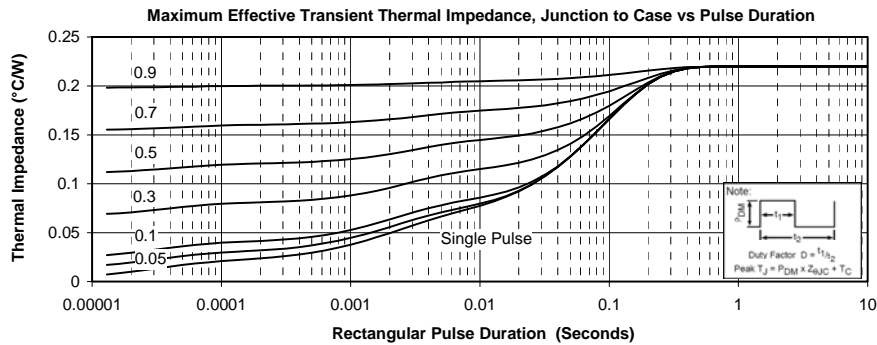

Microsemi reserves the right to change, without notice, the specifications and information contained herein