

Wide Frequency range Timing-Safe™ Peak EMI reduction IC

General Features

- 1x , LVCMOS Timing-Safe™ Peak EMI Reduction
- Input frequency:
 - 12MHz - 150MHz @ 2.5V
 - 15MHz - 175MHz @ 3.3V
- Output frequency (Timing-Safe™):
 - 12MHz - 150MHz @ 2.5V
 - 15MHz - 175MHz @ 3.3V
- Analog Spread Selection up to ±1%
- External Input-Output Delay Control option
- Power Down option for Power Save mode
- Supply Voltage: 2.5V±0.2V
3.3V ± 0.3V
- Commercial temperature range
- 8 pin, TSSOP, and TDFN(2X2) COL packages
- The First True Drop-in Solution

delivering a 1x Timing-Safe™ clock. PCS3P73Z01BW has a Frequency Selection (FS) control that facilitates selecting one of the two frequency ranges within the operating frequency range. *Refer to the frequency Selection table for details.* The device has an SSEXTR pin to select different deviations and associated Input-Output Skew (T_{SKEW}), depending upon the value of an external resistor connected between SSEXTR and GND. PCS3P73Z01BW has a DLY_CTRL for adjusting the Input-Output clock delay, depending upon the value of capacitor connected at this pin to GND. PD#/OE provides the Power Down option. Outputs will be tri-stated when power down is active.

PCS3P73Z01BW operates from a 2.5V/3.3V supply and is available in an 8 Pin TSSOP, and TDFN (2X2) COL Packages, over Commercial temperature range.

Functional Description

PCS3P73Z01BW is a 2.5V/3.3V versatile EMI reduction IC based on PulseCore Semiconductor’s patent pending Timing-Safe™ technology. PCS3P73Z01BW accepts one input from an external reference, and locks on to it

Application

PCS3P73Z01BW is targeted for use in Displays, Camera modules and high speed SDRAM memory interface systems.

Block Diagram

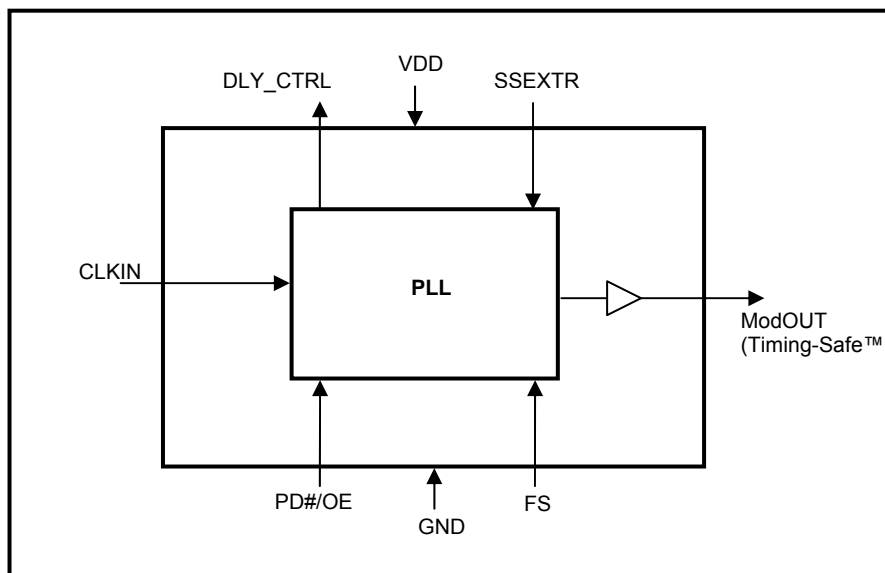

May 2008

rev 0.2

Pin Configuration

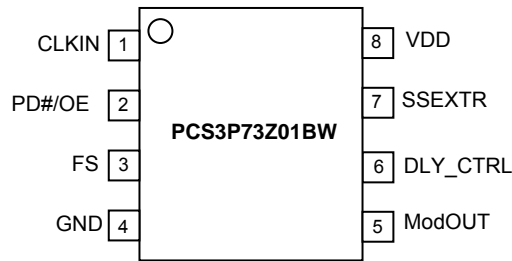

Pin Description

Pin #	Type	Pin Name	Description
1	I	CLKIN	External reference Clock input.
2	I	PD#/OE	Power Down. Pull LOW to enable Power Down. Outputs will be tri-stated when power down is enabled. Pull HIGH to disable power down and enable output.
3	I	FS	Frequency Select (see Frequency Selection table for details).
4	P	GND	Ground
5	O	ModOUT	Buffered modulated Timing-Safe™ clock output
6	O	DLY_CTRL	External Input-Output Delay control
7	I	SSEXTR	Analog Spread Selection through external resistor to GND.
8	P	VDD	2.5V / 3.3V supply Voltage

Frequency Selection Table

VDD	FS	Frequency(MHz)
2.5V	0	12-40
	1	40-150
3.3V	0	15-50
	1	50-175

Absolute Maximum Rating

Symbol	Parameter	Rating	Unit
V _{DD}	Voltage on any pin with respect to Ground	-0.5 to +4.6	V
T _{STG}	Storage temperature	-65 to +125	°C
T _s	Max. Soldering Temperature (10 sec)	260	°C
T _J	Junction Temperature	150	°C
T _{DV}	Static Discharge Voltage (As per JEDEC STD22- A114-B)	2	KV

Note: These are stress ratings only and are not implied for functional use. Exposure to absolute maximum ratings for prolonged periods of time may affect device reliability.

Operating Conditions

Parameter	Description	Min	Max	Unit
V _{DD(3.3V)}	Supply Voltage	3.0	3.6	V
V _{DD(2.5V)}	Supply Voltage	2.3	2.7	V
T _A	Operating Temperature (Ambient Temperature)	0	+70	°C
C _L	Load Capacitance		10	pF
C _{IN}	Input Capacitance		7	pF

Electrical Characteristics for 2.5V Supply

Parameter	Description	Test Conditions	Min	Typ	Max	Unit
V _{DD}	Supply Voltage		2.3	2.5	2.7	V
V _{IL}	Input LOW Voltage				0.7	V
V _{IH}	Input HIGH Voltage		1.7			V
I _{IL}	Input LOW Current	V _{IN} = 0V			50	μA
I _{IH}	Input HIGH Current	V _{IN} = V _{DD}			50	μA
V _{OL}	Output LOW Voltage	I _{OL} = 8mA			0.6	V
V _{OH}	Output HIGH Voltage	I _{OH} = -8mA	1.8			V
I _{CC}	Static Supply Current	CLKIN & PD#/OE pins pulled to GND			2	μA
I _{DD}	Dynamic Supply Current	Unloaded Output		12MHz	3	mA
				40MHz	7	
				150MHz	15	
Z _o	Output Impedance			36		Ω

Electrical Characteristics for 3.3V Supply

Parameter	Description	Test Conditions	Min	Typ	Max	Unit
V _{DD}	Supply Voltage		3.0	3.3	3.6	V
V _{IH}	Input HIGH Voltage		2.0			V
V _{IL}	Input LOW Voltage				0.8	V
I _{IH}	Input HIGH Current	V _{IN} = V _{DD}			50	μA
I _{IL}	Input LOW Current	V _{IN} = 0V			50	μA
V _{OH}	Output HIGH Voltage	I _{OH} = -8mA	2.4			V
V _{OL}	Output LOW Voltage	I _{OL} = 8mA			0.4	V
I _{CC}	Static Supply Current	CLKIN pulled Low, PD#/OE pulled Low			2	μA
I _{DD}	Dynamic Supply Current	Unloaded outputs		15MHz	5	mA
				50MHz	10	
				175MHz	25	
Z _o	Output Impedance			27		Ω

May 2008

rev 0.2

Switching Characteristics for 2.5V

Parameter	Test Conditions		Min	Typ	Max	Unit
Input Frequency	FS=0		12		40	MHz
	FS=1		40		150	
ModOUT	FS=0		12		40	
	FS=1		40		150	
Duty Cycle ^{1,2}	Measured at V _{DD} /2	≤ 100MHz	45	50	55	%
		≥100MHz	40	50	60	
Rise Time ^{1,2}	Measured between 20% to 80%			1.7		nS
Fall Time ^{1,2}	Measured between 80% to 20%			0.9		nS
Cycle-to-Cycle Jitter ²	Unloaded outputs	FS=0; @ 25 MHz		±175		pS
		FS=1; @ 66 MHz		±150		
Input-to-Output propagation Delay ²	Unloaded outputs with SSEXTR pin OPEN, No load on DLY_CTRL	FS=0; @ 25 MHz		250		pS
		FS=1; @ 66 MHz				
PLL Lock Time ²	Stable power supply, valid clock presented on CLKIN pin				3	mS

Notes:

- 1. All parameters are specified with 10 pF loaded outputs.
- 2. Parameter is guaranteed by design and characterization. Not 100% tested in production

Switching Characteristics for 3.3V

Parameter	Test Conditions		Min	Typ	Max	Unit
Input Frequency	FS=0		15		50	MHz
	FS=1		50		175	
ModOUT	FS=0		15		50	
	FS=1		50		175	
Duty Cycle ^{3,4}	Measured at V _{DD} /2	≤ 100MHz	45	50	55	%
		≥100MHz	40	50	60	
Rise Time ^{3,4}	Measured between 20% to 80%			1.2		nS
Fall Time ^{3,4}	Measured between 80% to 20%			0.8		nS
Cycle-to-Cycle Jitter ⁴	Unloaded outputs	FS=0; @ 25 MHz		±150		pS
		FS=1; @ 66 MHz		±125		
Input-to-Output propagation Delay ⁴	Unloaded outputs with SSEXTR pin OPEN, No load on DLY_CTRL	FS=0; @ 25 MHz		350		pS
		FS=1; @ 66 MHz				
PLL Lock Time ⁴	Stable power supply, valid clock presented on CLKIN pin				3	mS

Notes:

- 3. All parameters are specified with 10 pF loaded outputs.
- 4. Parameter is guaranteed by design and characterization. Not 100% tested in production

Switching Waveforms

Duty Cycle Timing

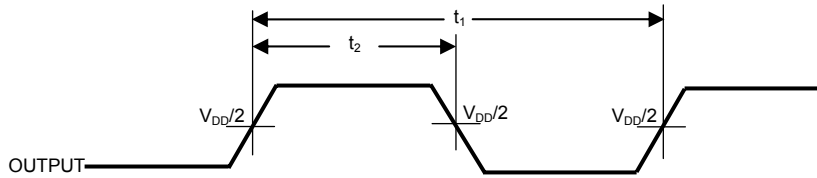

All Outputs Rise/Fall Time

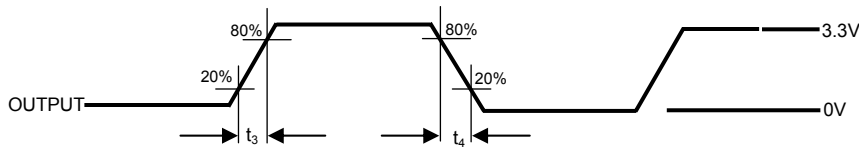

Input - Output Propagation Delay

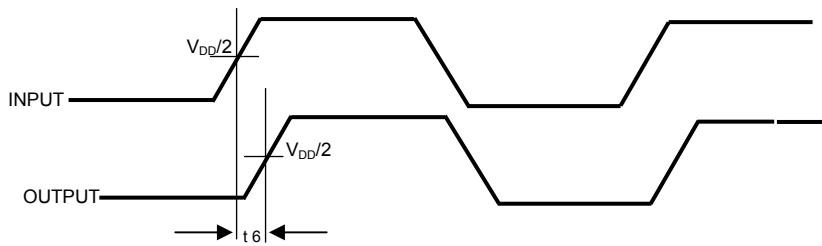

Input-Output Skew

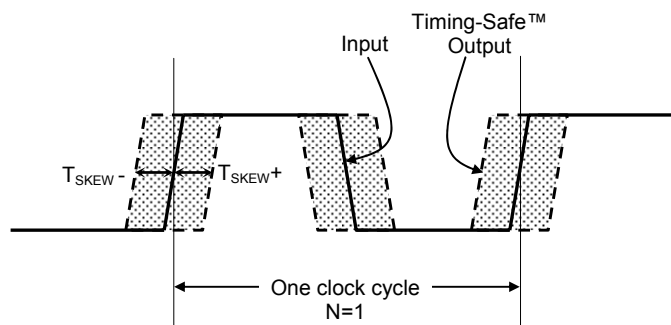

T_{SKEW} represents input-output skew when spread spectrum is ON
 For example, $T_{SKEW} = \pm 0.20$ for an Input clock of 12MHz, translates in to $(1/12MHz) * 0.20 = 16.66nS$

Note: Tskew is measured in units of Clock Period

Typical example of Timing-Safe™ waveform

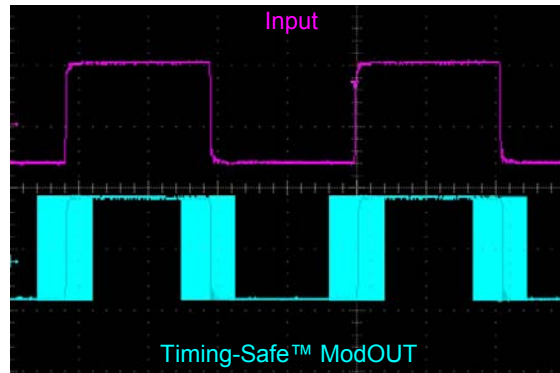
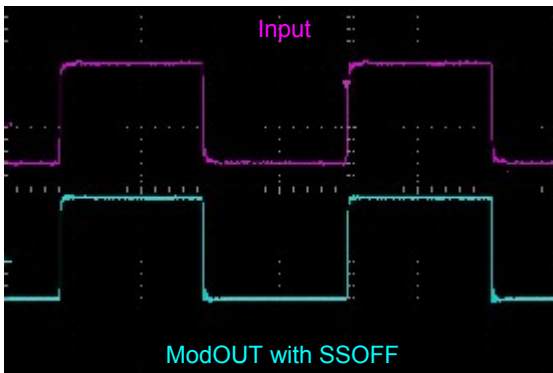

Typical Application Schematic

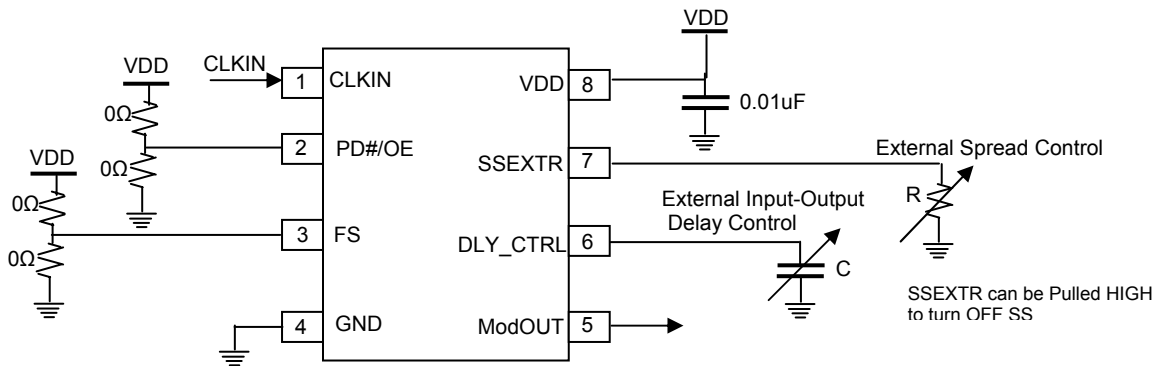

Note: Refer to Pin Description table for Functionality details

Charts (for VDD=2.5V±0.2V)

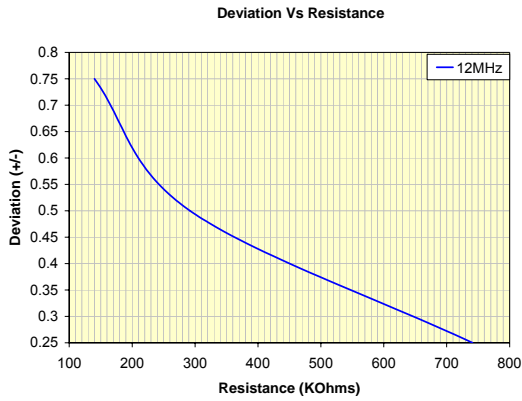

Fig1: Deviation Vs Resistance (12MHz, FS=0)

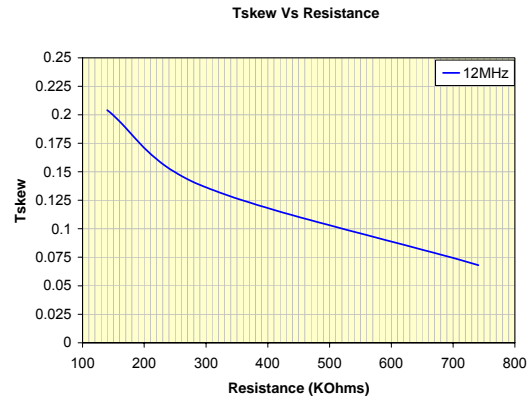

Fig2: Tskew Vs Resistance (12MHz, FS=0)

Charts (for VDD=2.5V±0.2V and 3.3V±0.3V)

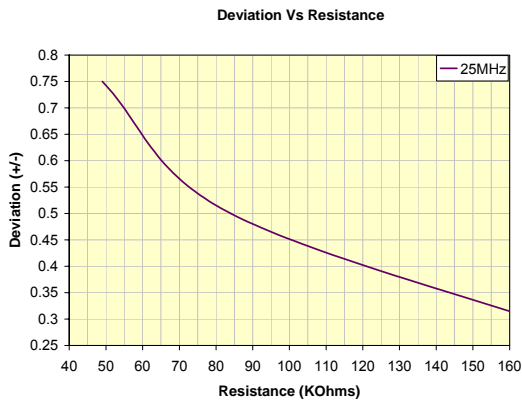

Fig3: Deviation Vs Resistance (25MHz, FS=0)

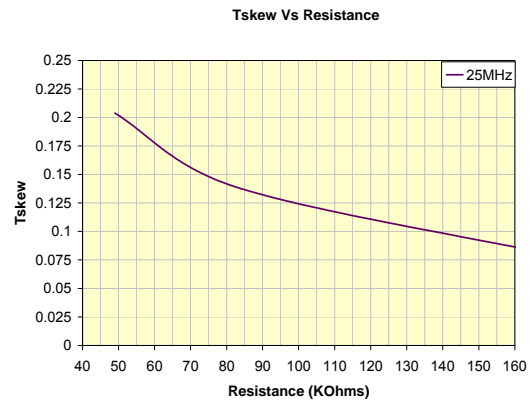

Fig4: Tskew Vs Resistance (25MHz, FS=0)

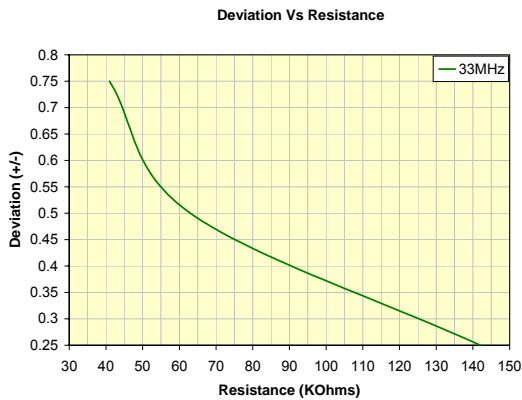

Fig5: Deviation Vs Resistance (33MHz, FS=0)



Fig6: Tskew Vs Resistance (33MHz, FS=0)

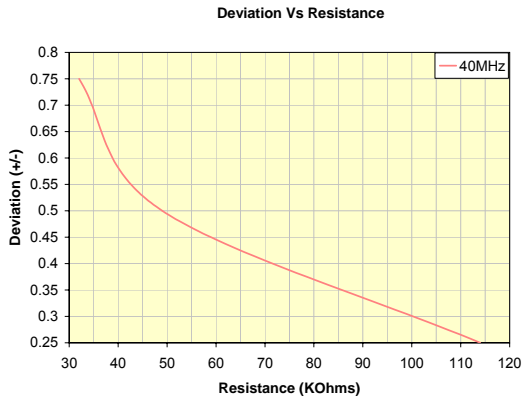

Fig7: Deviation Vs Resistance (40MHz, FS=0)

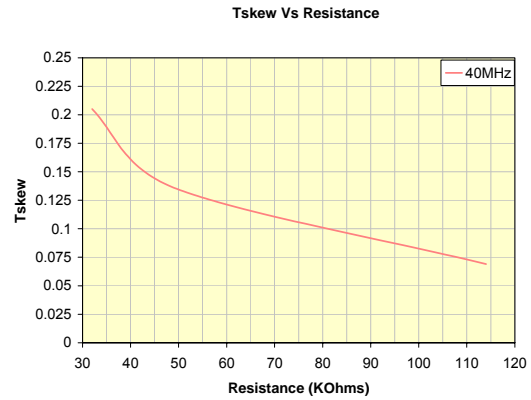

Fig8: Tskew Vs Resistance (40MHz, FS=0)

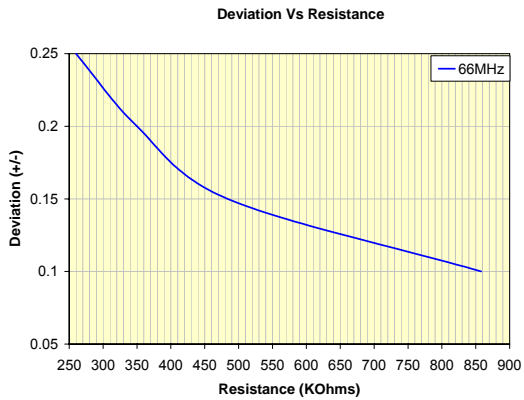

Fig9: Deviation Vs Resistance (66MHz, FS=1)

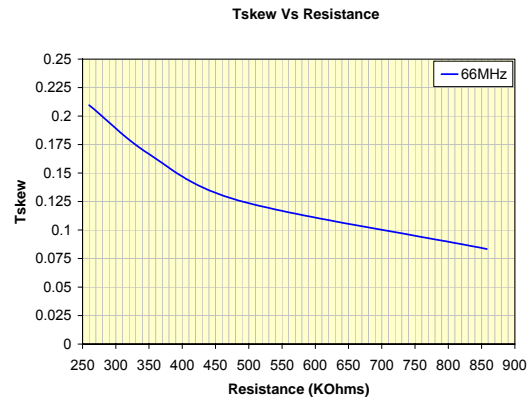

Fig10: Tskew Vs Resistance (66MHz, FS=1)

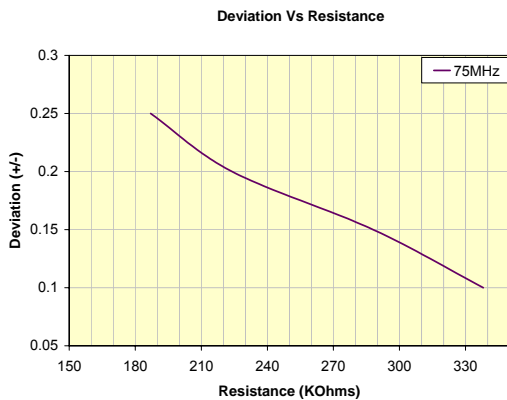

Fig11: Deviation Vs Resistance (75MHz, FS=1)

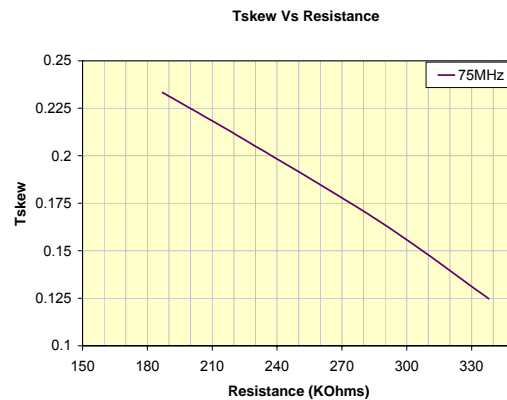

Fig12: Tskew Vs Resistance (75MHz, FS=1)

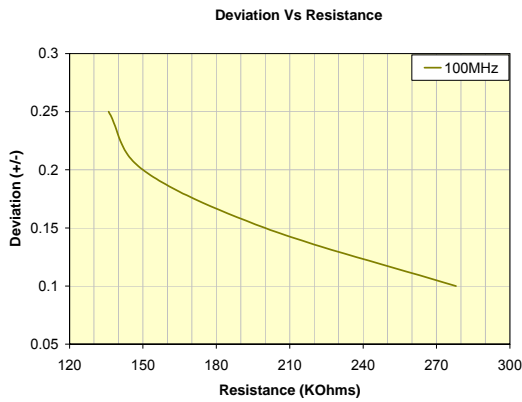

Fig13: Deviation Vs Resistance (100MHz, FS=1)

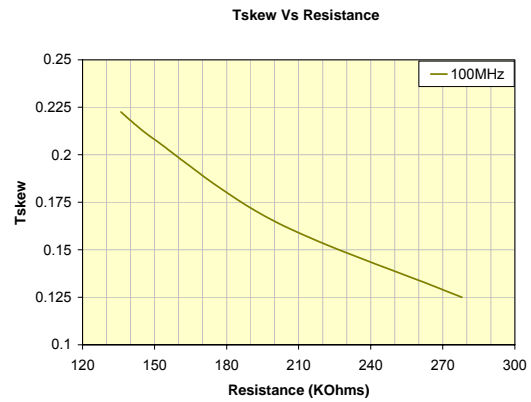

Fig14: Tskew Vs Resistance (100MHz, FS=1)

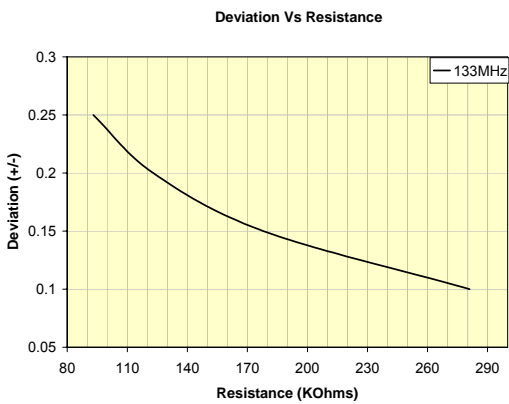

Fig15: Deviation Vs Resistance (133MHz, FS=1)

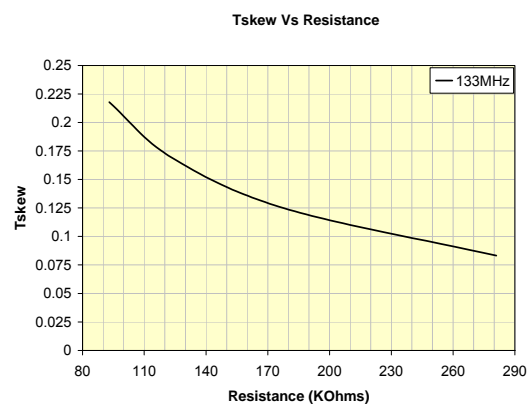

Fig16: Tskew Vs Resistance (133MHz, FS=1)

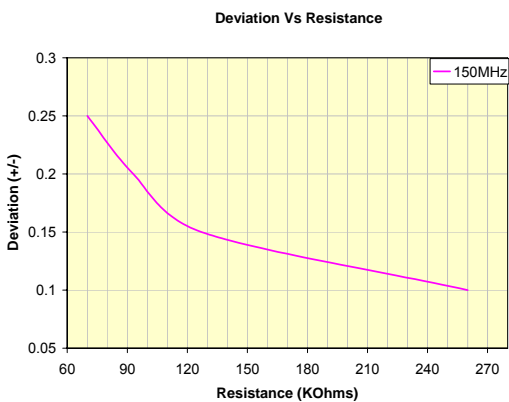

Fig17: Deviation Vs Resistance (150MHz, FS=1)

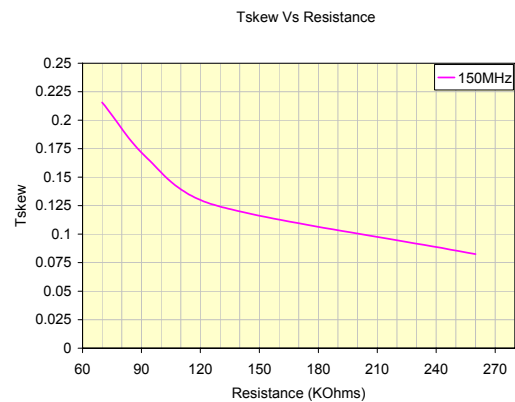

Fig18: Tskew Vs Resistance (150MHz, FS=1)

Charts (for VDD= 3.3V±0.3V)

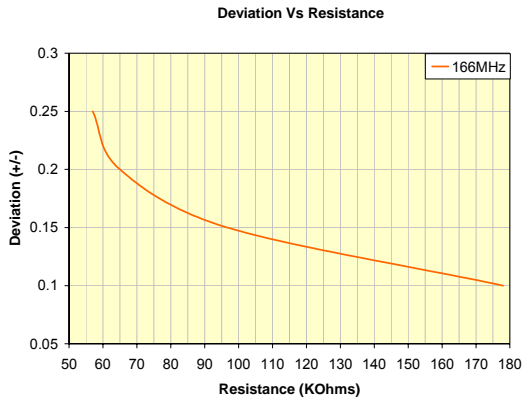

Fig19: Deviation Vs Resistance (166MHz, FS=1)

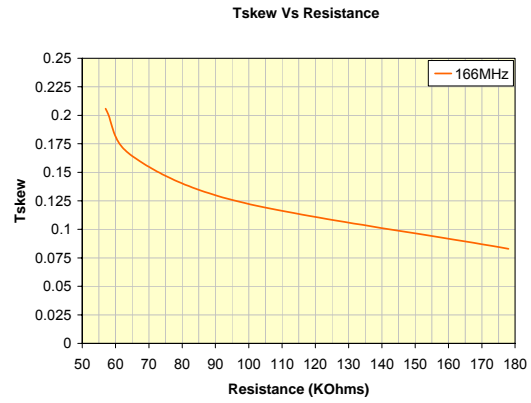

Fig20: Tskew Vs Resistance (166MHz, FS=1)

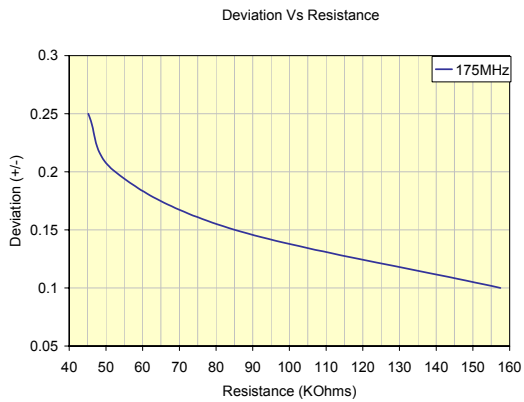

Fig21: Deviation Vs Resistance (175MHz, FS=1)

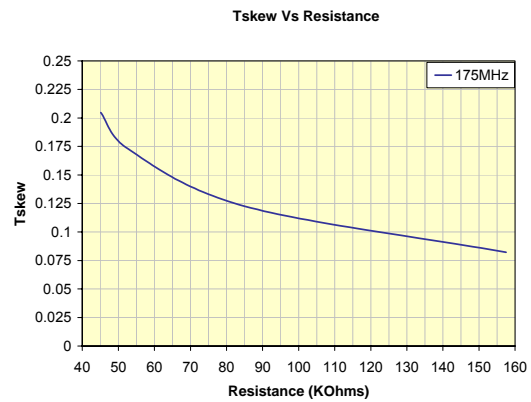

Fig22: Tskew Vs Resistance (175MHz, FS=1)

Charts (for VDD=2.5V±0.2V)

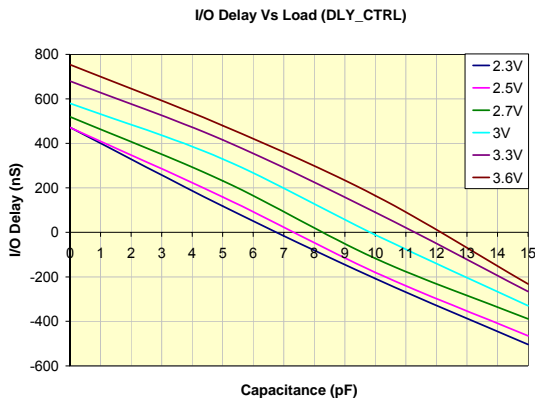

Fig23: I/O Delay Vs Load (DLY_CTRL)
(For 12MHz, FS=0)

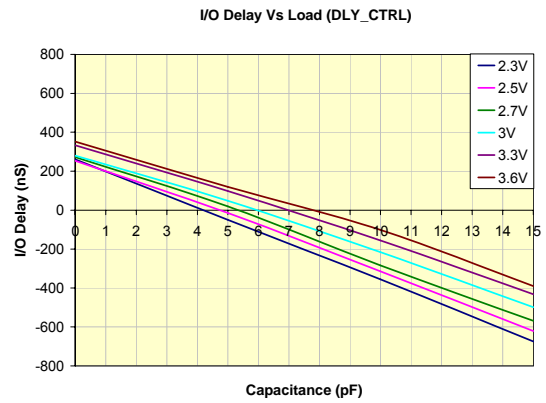

Fig24: I/O Delay Vs Load (DLY_CTRL)
(For 25MHz, FS=0)

Charts (for VDD=2.5V±0.2V and 3.3V±0.3V)

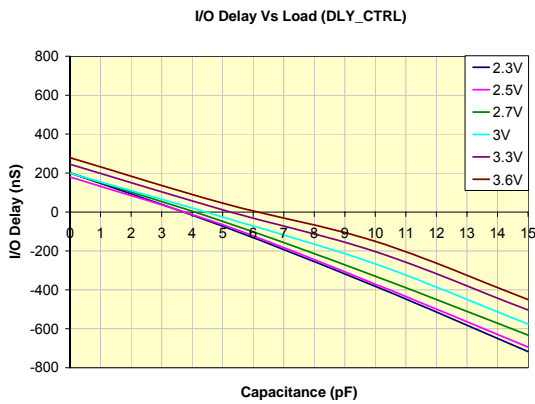

Fig25: I/O Delay Vs Load (DLY_CTRL)
(For 33MHz, FS=0)

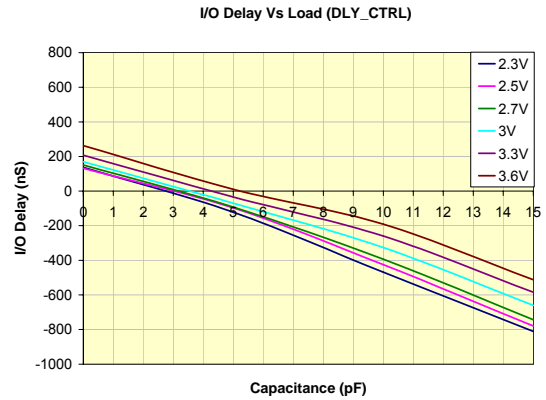

Fig26: I/O Delay Vs Load (DLY_CTRL)
(For 40MHz, FS=0)

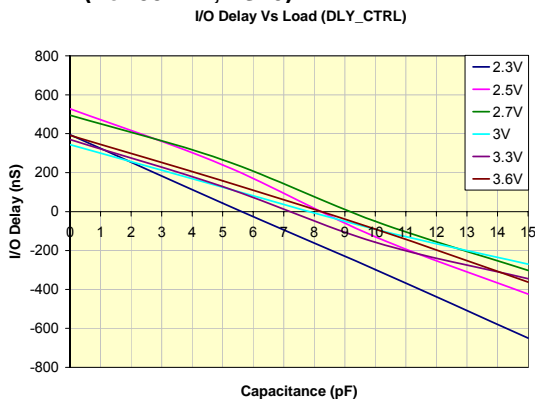

Fig27: I/O Delay Vs Load (DLY_CTRL)
(For 66MHz, FS=1)

rev 0.2

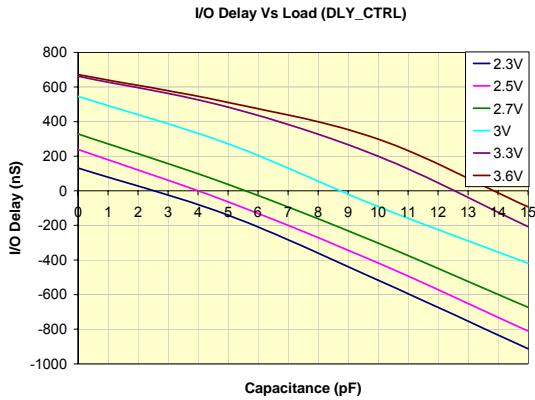

Fig28: I/O Delay Vs Load (DLY_CTRL)
(For 75MHz, FS=1)

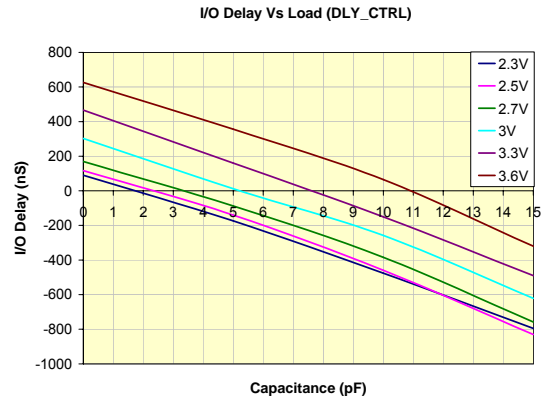

Fig29: I/O Delay Vs Load (DLY_CTRL)
(For 100MHz, FS=1)

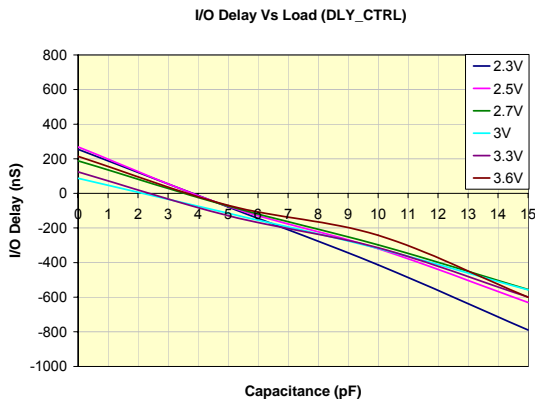

Fig30: I/O Delay Vs Load (DLY_CTRL)
(For 133MHz, FS=1)

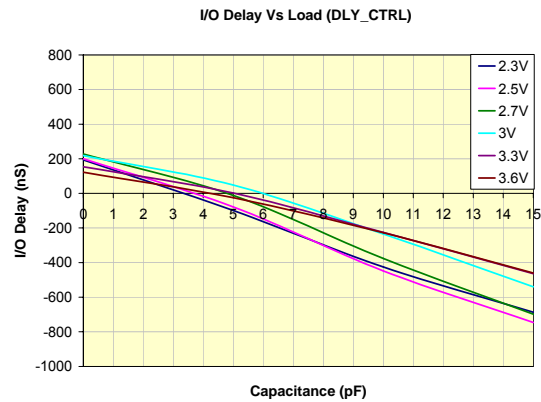

Fig31: I/O Delay Vs Load (DLY_CTRL)
(For 150MHz, FS=1)

Charts (for VDD= 3.3V±0.3V)

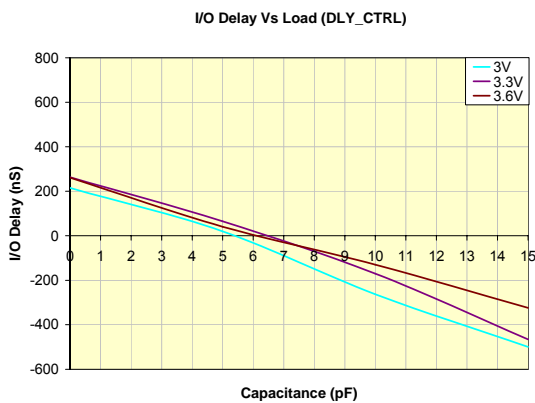

Fig32: I/O Delay Vs Load (DLY_CTRL)
(For 166MHz, FS=1)

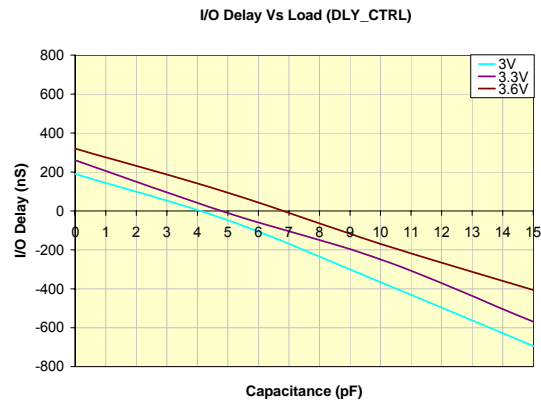
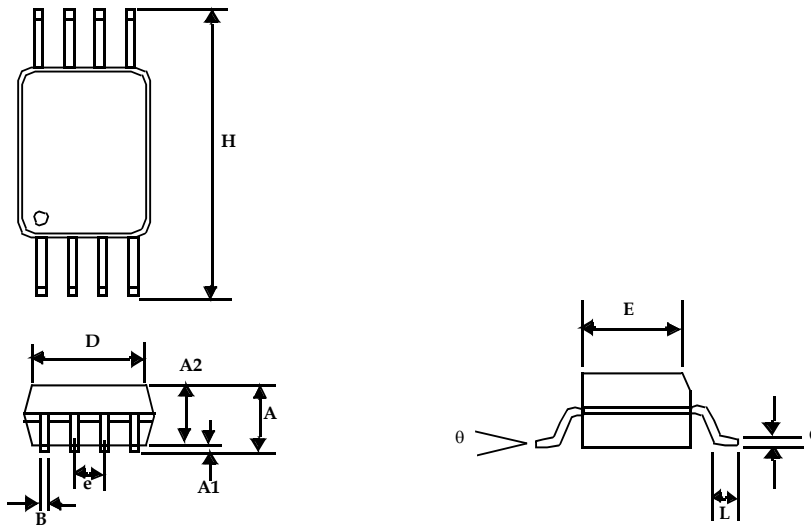

Fig33: I/O Delay Vs Load (DLY_CTRL)
(For 175MHz, FS=1)

Note: Device to Device variation of Deviation and I/O delay is ± 10%

Package Information

8-lead TSSOP Package (4.40-MM Body)



Symbol	Dimensions			
	Inches		Millimeters	
	Min	Max	Min	Max
A		0.043		1.10
A1	0.002	0.006	0.05	0.15
A2	0.033	0.037	0.85	0.95
B	0.008	0.012	0.19	0.30
c	0.004	0.008	0.09	0.20
D	0.114	0.122	2.90	3.10
E	0.169	0.177	4.30	4.50
e	0.026 BSC		0.65 BSC	
H	0.252 BSC		6.40 BSC	
L	0.020	0.028	0.50	0.70
θ	0°	8°	0°	8°

TDFN COL 2x2 8L package Outline drawing

TOP VIEW

BOTTOM VIEW

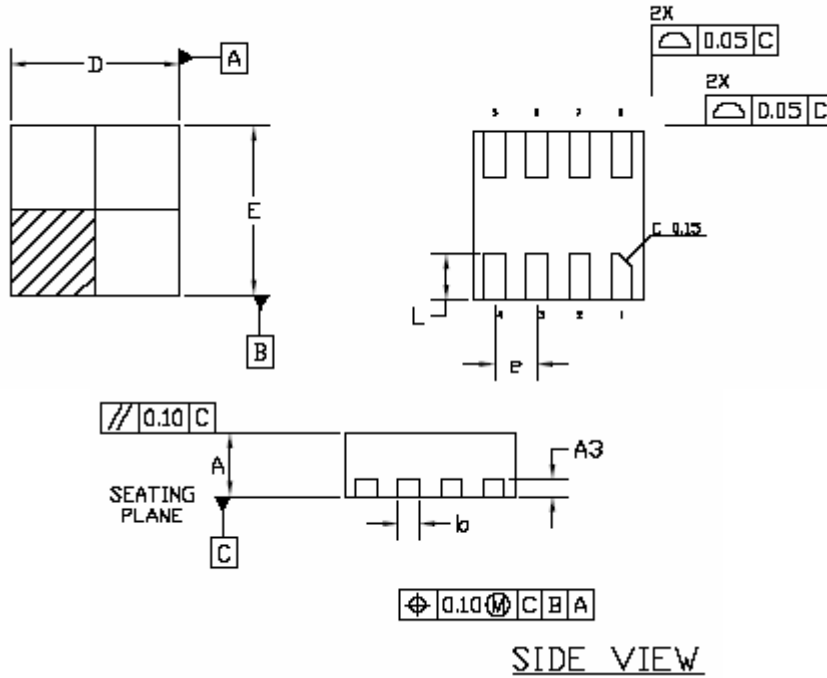

Symbol	Dimensions			
	Inches		Millimeters	
	Min	Max	Min	Max
A	0.027	0.0315	0.70	0.80
A3	0.008 BSC		0.203 BSC	
b	0.008	0.012	0.20	0.30
D	0.079 BSC		2.00 BSC	
E	0.078 BSC		2.00 BSC	
e	0.020 BSC		0.50 BSC	
L	0.020	0.024	0.50	0.60

Ordering Codes

Ordering Code	Marking	Package Type	Temperature
PCS3P73Z01BWG-08-TT	3P73Z01BWG	8-pin 4.4-mm TSSOP - TUBE, Green	Commercial
PCS3P73Z01BWG-08-TR	3P73Z01BWG	8- pin 4.4-mm TSSOP - TAPE & REEL, Green	Commercial
PCS3P73Z01BWG-08-CR	AF1LL	8- pin 2-mm TDFN COL - TAPE & REEL, Green	Commercial

LL = 2 Character LOT #

Device Ordering Information

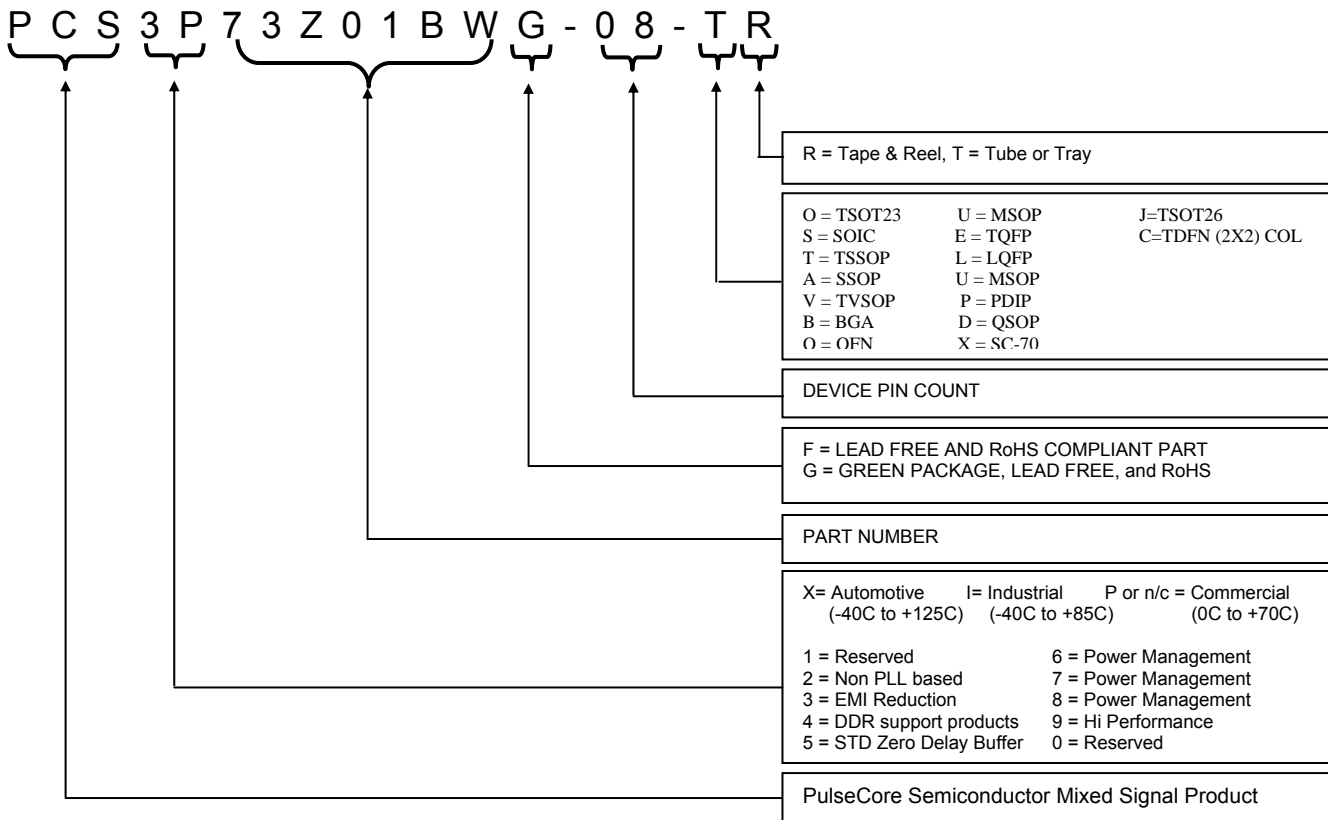



PulseCore Semiconductor Corporation
1715 S. Bascom Ave Suite 200,
Campbell, CA 95008
Tel: 408-879-9077
Fax: 408-879-9018
www.pulsecoresemi.com

Copyright © PulseCore Semiconductor
All Rights Reserved
Part Number: PCS3P73Z01BW
Document Version: 0.2

Note: This product utilizes US Patent # 6,646,463 Impedance Emulator Patent issued to PulseCore Semiconductor, dated 11-11-2003
Many PulseCore Semiconductor products are protected by issued patents or by applications for patent

© Copyright 2006 PulseCore Semiconductor Corporation. All rights reserved. Our logo and name are trademarks or registered trademarks of PulseCore Semiconductor. All other brand and product names may be the trademarks of their respective companies. PulseCore reserves the right to make changes to this document and its products at any time without notice. PulseCore assumes no responsibility for any errors that may appear in this document. The data contained herein represents PulseCore's best data and/or estimates at the time of issuance. PulseCore reserves the right to change or correct this data at any time, without notice. If the product described herein is under development, significant changes to these specifications are possible. The information in this product data sheet is intended to be general descriptive information for potential customers and users, and is not intended to operate as, or provide, any guarantee or warranty to any user or customer. PulseCore does not assume any responsibility or liability arising out of the application or use of any product described herein, and disclaims any express or implied warranties related to the sale and/or use of PulseCore products including liability or warranties related to fitness for a particular purpose, merchantability, or infringement of any intellectual property rights, except as expressly agreed to in PulseCore's Terms and Conditions of Sale (which are available from PulseCore). All sales of PulseCore products are made exclusively according to PulseCore's Terms and Conditions of Sale. The purchase of products from PulseCore does not convey a license under any patent rights, copyrights; mask works rights, trademarks, or any other intellectual property rights of PulseCore or third parties. PulseCore does not authorize its products for use as critical components in life-supporting systems where a malfunction or failure may reasonably be expected to result in significant injury to the user, and the inclusion of PulseCore products in such life-supporting systems implies that the manufacturer assumes all risk of such use and agrees to indemnify PulseCore against all claims arising from such use.