

Features

- Ultra-low Leakage Current
- Guard Ring Die Construction for Transient Protection
- Ideally Suited for Automatic Assembly
- Low Power Loss, High Efficiency
- Surge Overload Rating to 45A Peak

Mechanical Data

- Case: Molded Plastic
- Plastic Material: UL Flammability Classification Rating 94V-0
- Moisture sensitivity: Level 1 per J-STD-020A
- Terminals: Solder Plated Terminal - Solderable per MIL-STD-202, Method 208
- Also Available in Lead Free Plating (Matte Tin Finish). Please See Ordering Information, Note 4, on Page 2
- Marking: Type Number
- Polarity: Cathode Band or Cathode Notch
- Weight: 0.093 grams (approx.)
- Mounting Position: Any

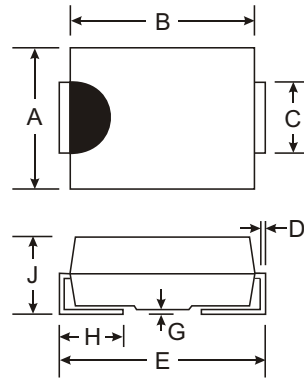

SMB		
Dim	Min	Max
A	3.30	3.94
B	4.06	4.57
C	1.96	2.21
D	0.15	0.31
E	5.00	5.59
G	0.10	0.20
H	0.76	1.52
J	2.00	2.62
All Dimensions in mm		

Maximum Ratings and Electrical Characteristics @ T_A = 25°C unless otherwise specified

Single phase, half wave, 60Hz, resistive or inductive load.
For capacitive load, derate current by 20%.

Characteristic	Symbol	B140HB	Unit
Peak Repetitive Reverse Voltage	V _{RRM}	40	V
Working Peak Reverse Voltage	V _{RWM}		
DC Blocking Voltage @ I _R = 0.1mA	V _R		
RMS Reverse Voltage	V _{R(RMS)}	28	V
Average Rectified Output Current @ T _T = 115°C	I _O	1.0	A
Non-Repetitive Peak Forward Surge Current 8.3ms Single half sine-wave superimposed on rated load	I _{FSM}	45	A
Non-Repetitive Peak Forward Surge Current 5μs Single half sine-wave	I _{FSM}	430	A
Forward Voltage @ I _F = 1.0A, @ T _j = 25°C @ I _F = 2.0A, @ T _j = 25°C @ I _F = 1.0A, @ T _j = 125°C @ I _F = 2.0A, @ T _j = 125°C	V _{FM}	0.53 0.70 0.49 0.64	V
Peak Reverse Current @ T _A = 25°C at Rated DC Blocking Voltage @ T _A = 125°C	I _{RM}	0.1 4.0	mA
Typical Total Capacitance (Note 2)	C _T	80	pF
Max. Voltage Rate of Change @ Rated V _R	dv/dt	5300	V/μs
Typical Thermal Resistance Junction to Terminal (Note 1)	R _{θJT}	36	°C/W

- Notes: 1. Thermal Resistance: Junction to terminal, unit mounted on PC board with 5.0 mm² (0.013 mm thick) copper pads as heat sink.
2. Measured at 1.0MHz and applied reverse voltage of 5.0V DC.

Ordering Information (Note 3 & 4)

Device*	Packaging	Shipping
B140HB-13	SMB	3000/Tape & Reel

- Notes: 3. For Packaging Details, go to our website at <http://www.diodes.com/datasheets/ap02007.pdf>.
 4. For lead free terminal plating part number, please add "-F" suffix to part number above. Example: B140HB-13-F.

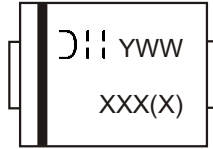

XXXX = Product type marking code, ex: B140HB (SMB package)
 D|| = Manufacturers' code marking
 YWW = Date code marking
 Y = Last digit of year ex: 2 for 2002
 WW = Week code 01 to 52

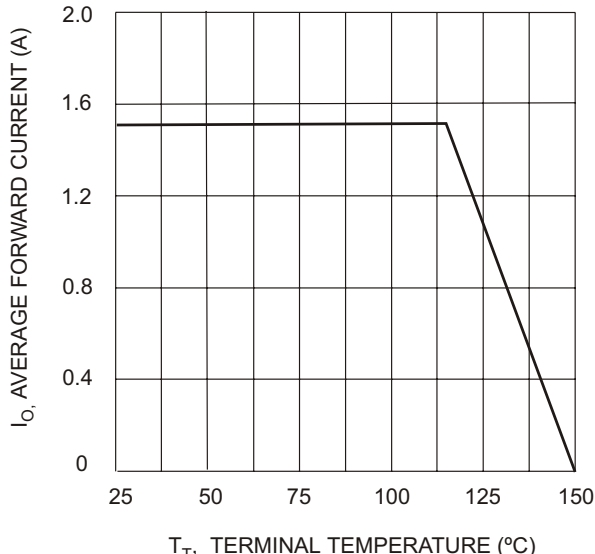

T_T , TERMINAL TEMPERATURE (°C)
Fig. 1 Forward Current Derating Curve

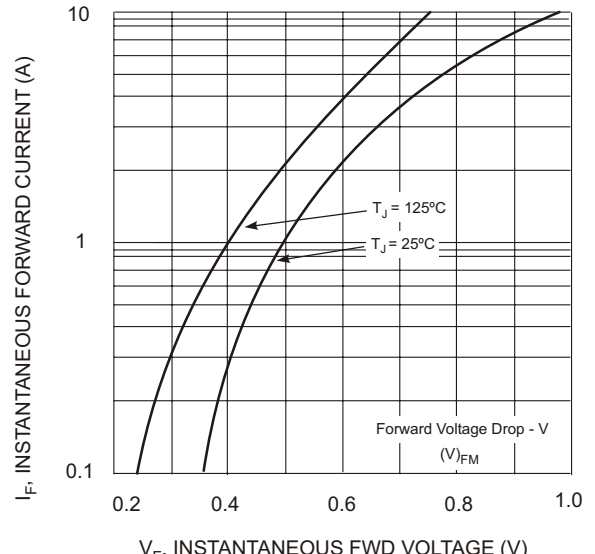

V_F , INSTANTANEOUS FWD VOLTAGE (V)
Fig. 2 Typ. Forward Characteristics

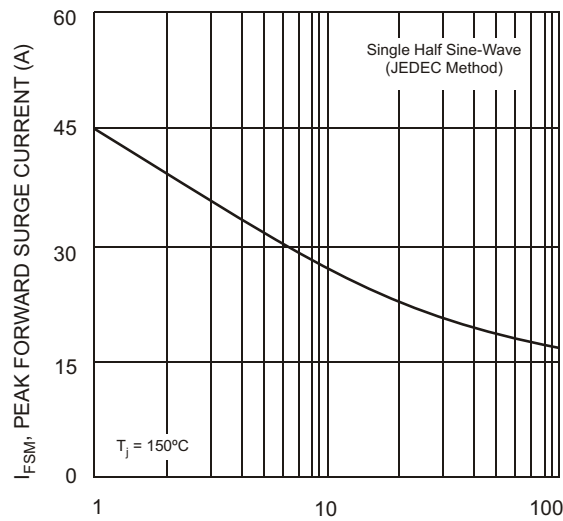

NUMBER OF CYCLES AT 60 Hz
Fig. 3 Max Non-Repetitive Peak Forward Surge Current

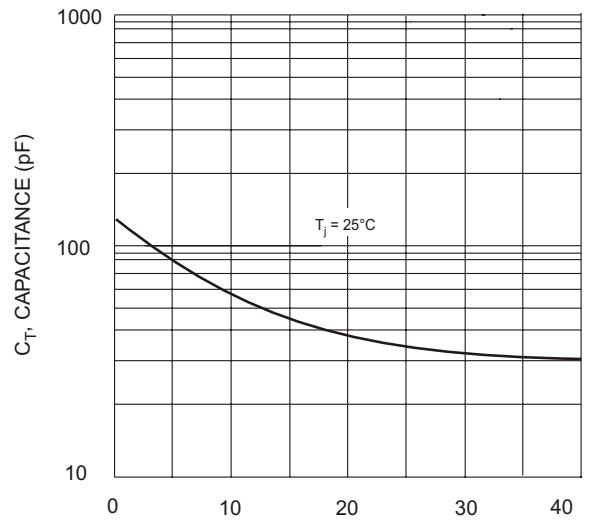

V_R , REVERSE VOLTAGE (V)
Fig. 4 Typical Total Capacitance

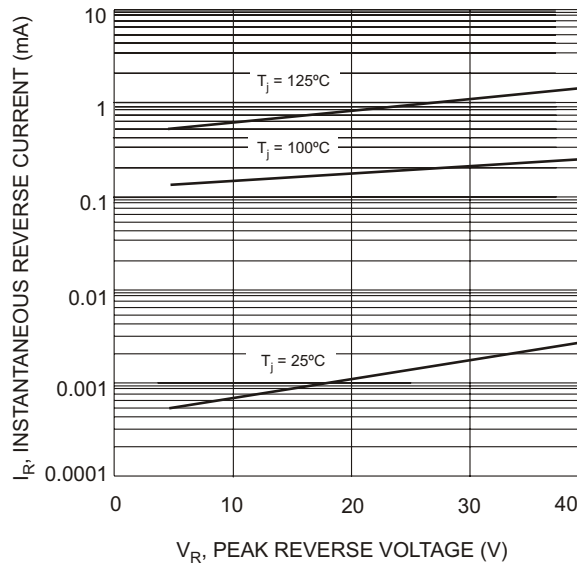

V_R , PEAK REVERSE VOLTAGE (V)
Fig. 5 Typical Reverse Characteristics