



## PROFESSIONAL TORQUE TESTER

# PRO-TEST 40, 400 & 1500ER

**OPERATOR'S HANDBOOK (PART No 34237) Issue 4**  
(ENGLISH)

FOR USE WITH PRO-TEST'S FITTED WITH VERSION 37701.101 & 37701.102 SOFTWARE

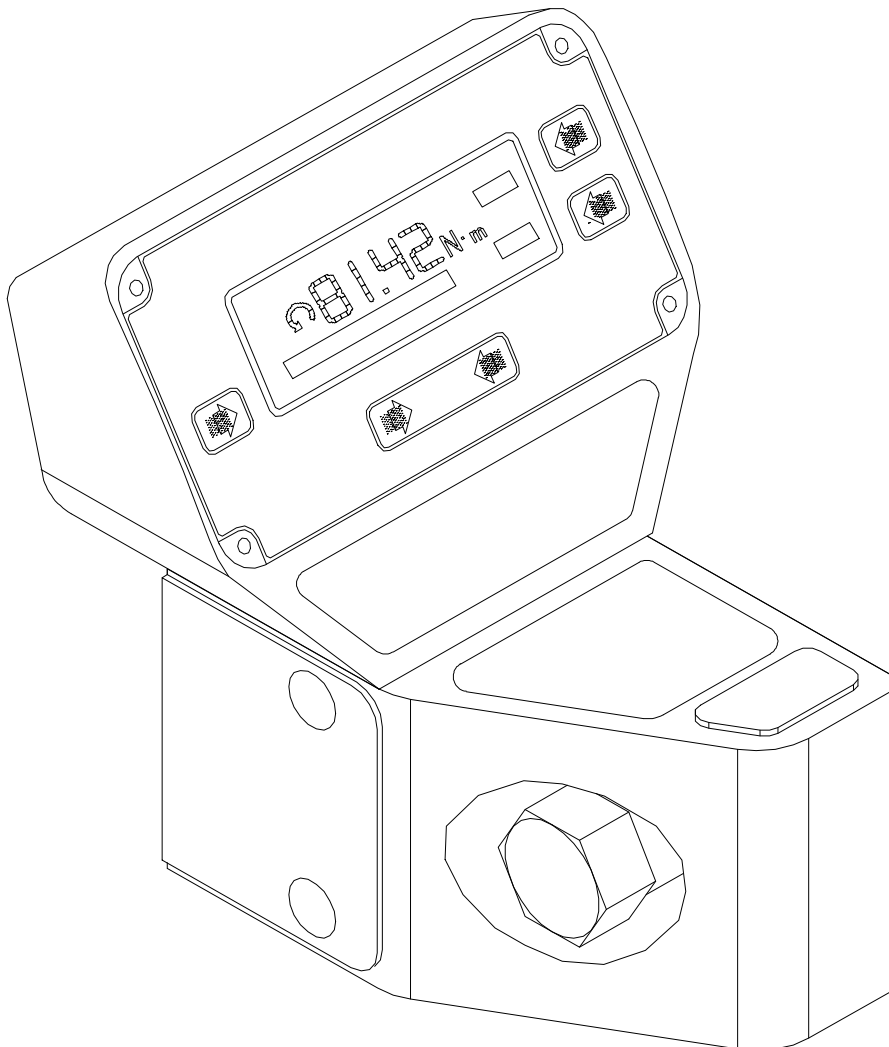

### MODEL NUMBERS COVERED BY THIS MANUAL

43180	PRO-TEST 40 TRANSDUCER
43181	PRO-TEST 400 TRANSDUCER
43189	PRO-TEST 1500ER TRANSDUCER
43184	PRO-TEST DISPLAY MODULE

## CONTENTS

	<u>PAGE</u>
Introduction	1
Assembly Diagram	1
Operating Instructions	2
Set Up Menus and Options	4
RS-232-C Serial Data Output Interface	6
Print Inhibit Controller Option	7
Specifications	8
Trouble Shooting	10

## INTRODUCTION

The Professional Torque Tester (Pro-Test) has been designed as an accurate, cost effective and easy to operate instrument for testing and calibrating all types of torque wrenches and torque limiting screw drivers.

Pro-Test transducers are mounted in aluminium cast housings along with all the necessary electronics to produce an output for the display module and RS-232-C interface. The housings can be mounted for either horizontal, clockwise, or anti-clockwise torque testing.

The function of the front panel buttons is identified on the display to facilitate quick and easy selection of the operating mode most suitable for the tool to be tested, i.e. track, peak memory with manual reset, peak memory with auto reset, first peak memory with manual reset, or first peak memory with auto reset. These buttons are also used to drive the Set-up Menu if changes to the operational parameters of the Pro-Test are required. These include, language of operation, measurement units to be enabled/disabled, RS-232-C communication parameters, auto reset hold time, first peak memory sensitivity and modes of operation to be enabled/disabled. The Zero button is only active in the track mode.

Pro-Test transducers are calibrated in the clockwise direction only as standard, the anti-clockwise direction of operation will be inhibited unless the transducer has been additionally calibrated in this direction. The direction of use is identified on the display and RS232C output

Optional extra's include a Mounting Bracket, 1" sq x 36mm Hex Socket, Print Inhibit Controller, Data Printer and 12 Volt DC power supply for use in vehicles.

## ASSEMBLY DIAGRAM

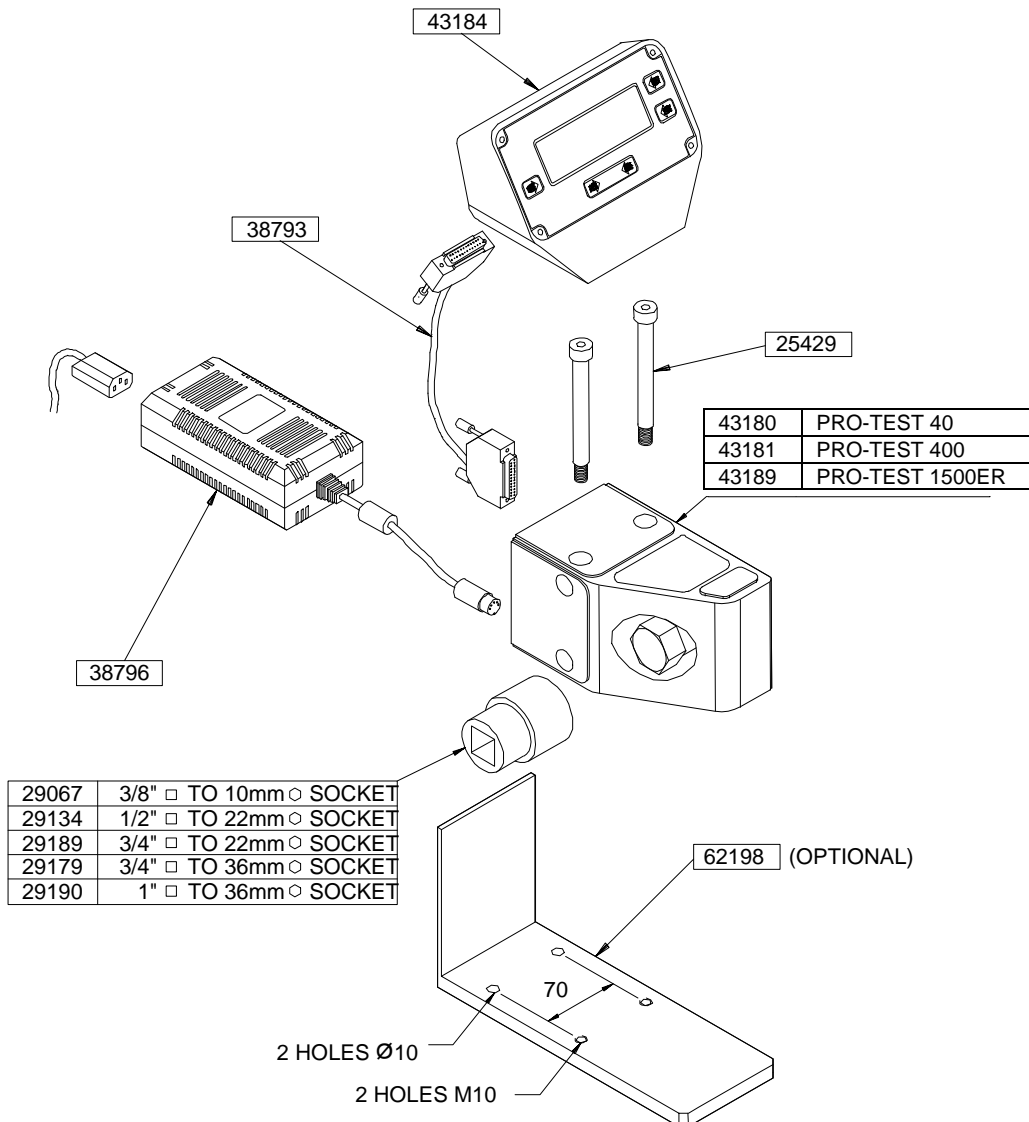

## OPERATING INSTRUCTIONS

1. Securely mount the Pro-Test transducer in the plane of operation required to a bench top, wall or the additional mounting bracket (part number 62198) with the 2 fixing bolts supplied.

### IMPORTANT !

The un-bolted end of the unit, must always be in contact with a supporting surface.

### MOUNTING POSITION TO ENABLE CLOCKWISE TESTING.

(bolts to be hand tightened with allen key provided)

Vertical  
Testing  
(bench mounted)

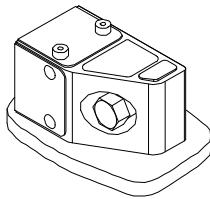

Vertical  
Testing  
(wall mounted)

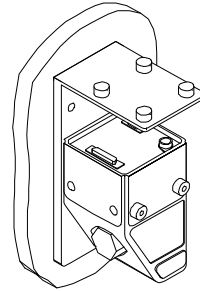

### MOUNTING POSITION TO ENABLE ANTI-CLOCKWISE TESTING.

(bolts to be hand tightened with allen key provided)

Vertical  
Testing  
(bench mounted)

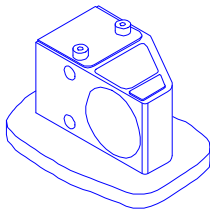

Vertical  
Testing  
(wall mounted)

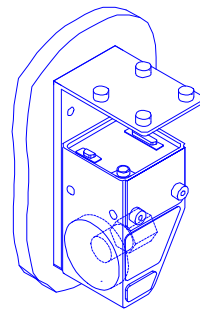

### MOUNTING POSITION TO ENABLE CLOCKWISE AND ANTI-CLOCKWISE TESTING

Horizontal  
Testing  
(bench mounted)

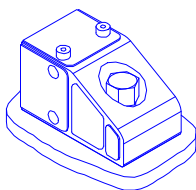

Vertical  
Testing  
(wall mounted)

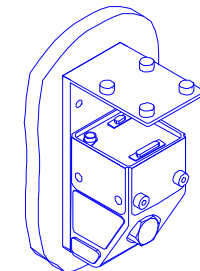

### IMPORTANT !

Bolts must be torque tightened to 50 Nm, and replaced when removed.

2. Locate the 2 holes in the bottom of the Pro-Test Display Unit on to the bolt heads protruding from the transducer housing. Fit connecting lead between Display Unit and Transducer.

3. Plug Power Supply into back of transducer housing then plug mains lead into Power Supply. If a mains plug is not fitted, wire as follows :

BROWN-LIVE                      BLUE-NEUTRAL                      GREEN / YELLOW-EARTH

**WARNING! It is important that live, neutral and earth are all connected between the Pro-Test and mains power supply. If no earth is available (2 wire mains power supply) it is recommended that a separate earth is connected between the transducer housing (the bottom right hand fixing screw in the corner of the back panel is ideal) and a suitable earth.**

4. If power supply has an ON/OFF fitted, switch to 'ON'.
5. Wait 2 seconds for initialisation and allow 5 minutes for the instrument to warm up and stabilise, then press 'ZERO'.
6. Select required units of measurement. Pressing the 'SELECT UNITS' button once will step onto the next available unit of measurement.
7. Select mode of measurement required. Pressing the 'MODE' button once will step onto the next available.

**BENDING BEAM WRENCHES, DIAL TYPE WRENCHES & TORQUE SCREWDRIVERS:- \_\_\_\_\_**

INSTRUMENT MODE :	Peak memory with manual reset or Peak memory with auto reset
-------------------	---

**PRESET (CLICK) WRENCHES & TORQUE SCREWDRIVERS:- \_\_\_\_\_**

INSTRUMENT MODE :	First peak memory with manual reset or First peak memory with auto reset
-------------------	---

8. Fit adapter supplied to hex drive of transducer, then tool to be tested to square of adapter.
9. Operate tool to be tested.
10. If the Pro-Test is loaded in a 'MANUAL RESET' mode, press 'RESET' to clear the display after the torque has been removed. If an 'AUTO RESET' mode is used, the display will clear automatically after the torque has been removed.

*NOTE:- If the equipment is used in a manner not specified by the manufacturer, the protection provided by the equipment could be impaired.*

## SET UP MENUS AND OPTIONS

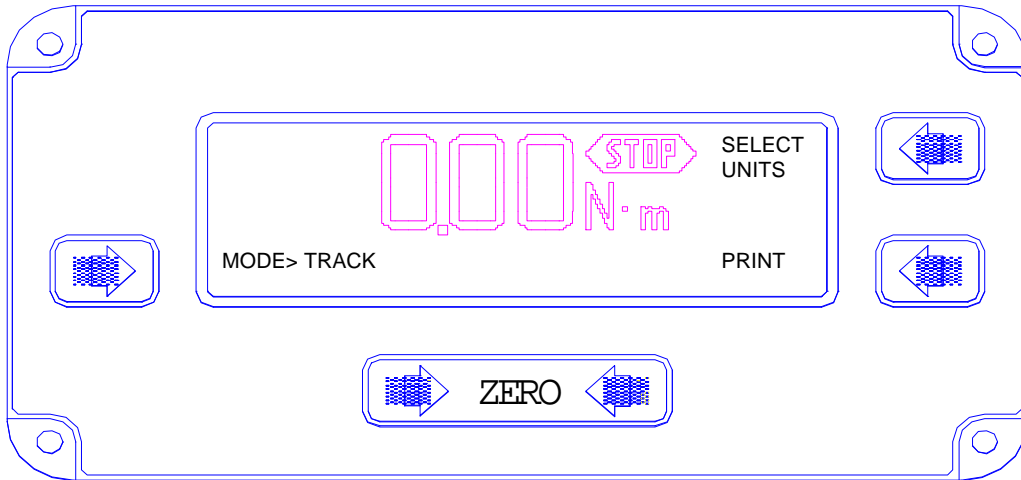

To enter 'SET UP' mode, press 'SELECT UNITS' & 'PRINT' buttons simultaneously, then release upon which the 'SOFTWARE VERSION NUMBER' will be displayed for 2 seconds.

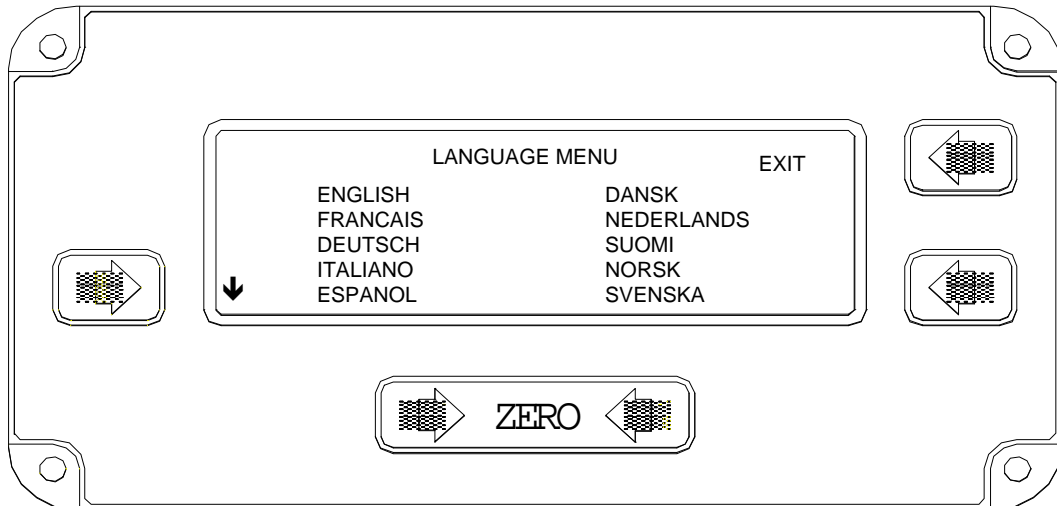

Repeatedly press the '↓' button until desired language of operation flashes, then press 'EXIT'.

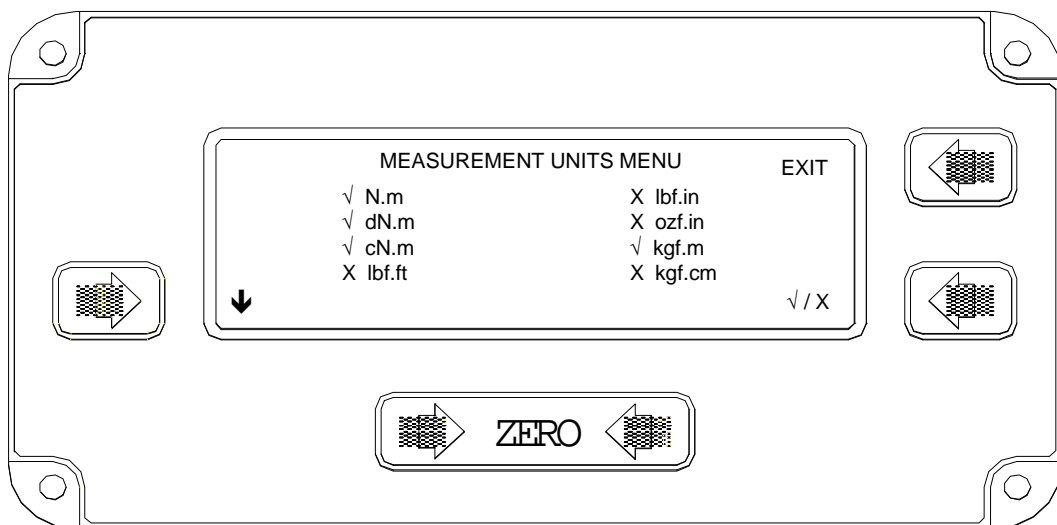

To enable/disable a unit of measurement repeatedly press the '↓' button until the desired unit flashes then press '√ / X' (√ = enabled, X = disabled). When all selections have been made, press 'EXIT'.

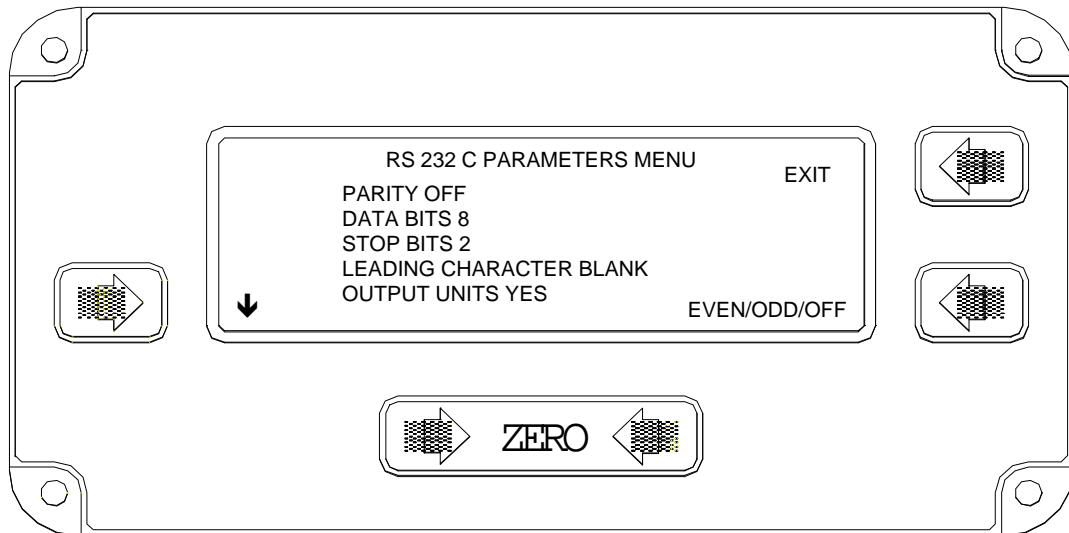

Select desired parameter by repeatedly pressing '↓' until text flashes. To change the setting, press the bottom right hand button, this button changes its function as each parameter is selected. When all selections have been made, press 'EXIT'.

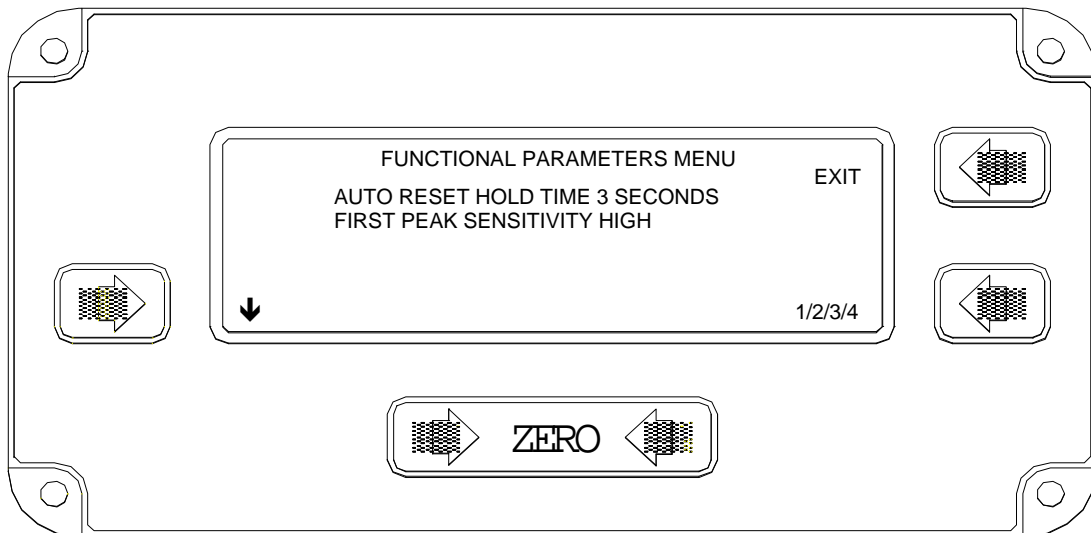

Select desired functional parameter by repeatedly pressing '↓' until text flashes. To change the setting, press the bottom right hand button, this button changes its function as each parameter is selected. When all selections have been made, press 'EXIT'.

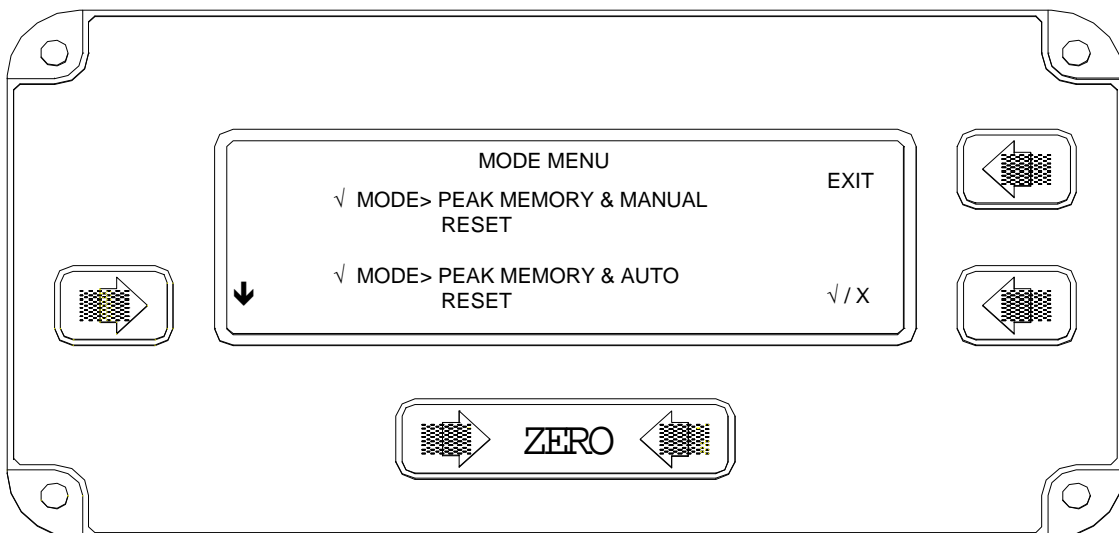

To enable/disable a mode of measurement repeatedly press '↓' until the desired mode flashes, then press '√ / X'. There are 4 modes of measurement of which 2 will be displayed at any one time. When all selections have been made, press 'EXIT', this will take the Pro-Test out of 'SET UP' mode.

## RS-232-C SERIAL DATA OUTPUT INTERFACE

Output of both measured value and units of measurement (as shown on the display) are in a familiar serial data format for communication with computers, printers, etc.

Data is output on the RS-232-C interface automatically when the memory auto-reset mode timer operates, when the 'MEMORY RESET' button is pressed, or by pressing the PRINT' button when in track mode. Output can be requested externally when the 'request to send' pin is taken HIGH.

### RS-232-C INTERFACE SPECIFICATIONS :- \_\_\_\_\_

Data rate fixed at 1200 baud.

Control Word Options - Parity = odd, even or off.  
- data bits = 7 or 8.  
- stop bits = 1 or 2.

All Options are menu selectable (see page 4) and are initially factory set to 8 data bits, 2 stop bits, and no parity

Transmitted data voltage levels +9 volts to -9 volts.

### RS-232-C OUTPUT PIN CONNECTIONS :- \_\_\_\_\_

PIN No	FUNCTION
1	Arm LED for print inhibit option.
2	Received data (from P.C)
3	Transmitted data (from Pro-Test)
4	Mode switch for print inhibit option.
5	Signal ground 0V.
6	Arm switch for print inhibit option.
7	Request to send to Pro-Test (Low to High transition)
8	+ 5 volts (from Pro-Test) <b>WARNING: Not for powering external devices.</b>
9	Calibration Mode Enable input (Active Low)

### RS-232-C DATA OUTPUT EXAMPLES :- \_\_\_\_\_

Code : DP=Decimal Point. CR=Carriage Return. SP=SPace.

- Using the Pro-Test 400 set to the standard data string. Reading 368.4 N m (clockwise).

3	6	8	DP	4	SP	N	DP	m	CR
---	---	---	----	---	----	---	----	---	----

- Using the Pro-Test 400 set to the standard data string. Reading 45.2 N m (anti-clockwise).

-	4	5	DP	2	SP	N	DP	m	CR
---	---	---	----	---	----	---	----	---	----

- Using the Pro-Test 1500ER set to the standard data string. Reading 1108 lbf ft (clockwise).

1	1	0	8	SP	l	b	f	DP	f	t	CR
---	---	---	---	----	---	---	---	----	---	---	----



**MITUTOYO DATA PROCESSORS :-** \_\_\_\_\_

The instrument can be configured to communicate to Mitutoyo DP3DX, DP7, QM1000 and QM5000 families of data processors.

For DP3DX, DP7, QM1000 and QM5000 families, the units of measurement must be inhibited.

For DP3DX and DP7 families, a '+' character must be added to the start of the data stream This is in addition to the units of measurement being inhibited.

See SET-UP MENU section.

**WIRING THE PRO-TEST TO DATA PROCESSORS:-**

PRO-TEST RS-232-C OUTPUT		MITUTOYO RS-232-C INPUT
CONNECTOR COVER	CABLE SCREEN	
PIN 3		PIN 3
PIN 5		PIN 7

For DP3DX & DP7 link pins 1 to 5 and 4 to 8 on Mitutoyo RS-232-C input.  
For QM1000 & QM5000 link pins 4 to 5 and 6 to 8 on Mitutoyo RS-232-C input.

For more information please consult your Mitutoyo data processor manual.  
*MITUTOYO is a registered trade mark of Mitutoyo (UK) Ltd.*

**PRINT INHIBIT CONTROLLER OPTION  
PART NUMBER 60167**

**INTRODUCTION :-** \_\_\_\_\_

The print inhibit controller is a remote, hand held device for controlling the RS-232-C output from the Pro-Test. This option can be retro fitted to any Pro-Test transducer, model numbers 43180-43183.

This option can control unwanted RS-232-C data input to printers, calibration and data collection systems.

**OPERATION :-** \_\_\_\_\_

Position of ' PRINT NORMALLY/ PRINT WHEN ARMED' switch :-

SWITCH POSITION	STATE OF INDICATOR	ACTION
'PRINT NORMALLY'	UNARMED	The RS-232-C output acts as normal. Every time an output is requested it will be issued.
'PRINT WHEN ARMED'	UNARMED	The RS-232-C output is inhibited, so will not function.
'PRINT WHEN ARMED'	ARMED (Having pressed button on controller)	When the ' ARM ' button is pressed, the arm led will light so indicating that the next request to send data will be acted upon.  Upon the next data output taking place, the arm led will turn off and the RS-232-C output will again be inhibited.  To obtain further data output either press the 'ARM' button or switch to 'PRINT NORMALLY'.

## SPECIFICATIONS

**PRO - TEST TRANSDUCER SPECIFICATION :-** \_\_\_\_\_

	<b>PRO-TEST 40</b>	<b>PRO-TEST 400</b>	<b>PRO-TEST 1500ER</b>
<b>RANGE OF OPERATION</b>	0 to 40 N.m	0 to 400 N.m	0 to 1500 N.m
<b>CALIBRATION RANGE</b>	5% to 100% of full scale. 2 to 40 N.m.	5% to 100% of full scale. 20 to 400 N.m.	2% to 100% of full scale. 30 to 1500 N.m.
<b>TRANSDUCER OVERLOAD CAPACITY</b>	150% of Pro-Test calibration range (60 N.m).	150% of Pro-Test calibration range (600 N.m).	150% of Pro-Test calibration range (2250 N.m).
<b>DIMENSIONS Height x Width x Depth (mm)</b>	106 x 106 x 185.	106 x 106 x 185.	106 x 106 x 185.
<b>DRIVE ADAPTERS</b>	3/8" sq to 10 mm hex socket	1/2" sq to 22 mm hex socket 3/4" sq to 22 mm hex socket	3/4" sq to 36 mm hex socket
<b>WEIGHT</b>	3.9 kg (8.6 lb).	4.0 kg (8.9 lb).	4.9 kg (10.8 lb).

**PRO-TEST DISPLAY UNIT SPECIFICATION :-** \_\_\_\_\_

READOUT	240 x 64 pixel dot matrix display giving direction of torque applied, 4 full digits, direct readout of engineering units, stop loading indicator and front panel button identification in all modes of operation and set up menu's.
DISPLAY UPDATE RATE	2 per second (2Hz).
RESOLUTION	1 Digit in 9999.
WEIGHT	2.4 kg (5.3 lb)
DIMENSIONS	128 mm high x 185 mm wide x 102 mm deep.

**SYSTEM SPECIFICATIONS :-**

ACCURACY	+/-1% of reading over calibration range.
ZERO SUPPRESSION	TRACK None.
	ALL MEMORY MODES Suppressed from 0 to approximately 0.5% of transducer calibration range.
UNITS OF MEASUREMENT	PRO-TEST 40 N.m, dN.m, cN.m, lbf.ft, lbf.in, ozf.in, kgf.m, kgf.cm. (Menu Selectable).
	PRO-TEST 400 N.m, dN.m, lbf.ft, lbf.in, kgf.m, kgf.cm. (Menu Selectable).
	PRO-TEST 1500ER N.m, lbf.ft, lbf.in, kgf.m. (Menu Selectable).
MEMORY AUTO-RESET TRIGGER	2.5%(High), 5%(Med), or 10%(Low) of reading (Menu Selectable).
MEMORY AUTO RESET HOLD TIMES	1, 2, 3 or 4 seconds (Menu Selectable).
OPERATING TEMP RANGE	+5°C to +40°C.
STORAGE TEMP RANGE	-20°C to +70°C.
MAXIMUM OPERATING HUMIDITY	85% Relative Humidity @30°C.
POWER REQUIREMENTS	90 to 264 Volts AC at 50-60 Hz.
POWER CONSUMPTION	12.0 W - maximum.
POWER CABLE	2 meters (6 ft 6 ins) long minimum.
POWER PLUG FUSE (if fitted)	1 Amp
CASE MATERIALS / FINISH	Display and Transducer housings engineered in aluminium castings. Finished in powder coated paint.
ENVIRONMENT	Indoor use within a light industrial environment.
ELECTROMAGNETIC COMPATIBILITY (EMC) DIRECTIVE	In conformance with EN 50081-1 : 1992 & EN 50082-1 : 1992.
LOW VOLTAGE DIRECTIVE	In conformance with EN 61010-1 : 1993. To environmental conditions Pollution Degree 2 & Installation Category (Overvoltage Category) II.
TIME/DATE COMPLIANCE	This equipment does not utilise time or date functions and thus will not be affected by the issues of date compliance in the future.

*Due to continuous improvement all specifications are subject to change without prior notice.*

## TROUBLE SHOOTING

### 1. No display when power is switched on.

- a) Check the Power Supply Module is correctly plugged into the back of the transducer housing.
- b) Check fuse in mains power plug.
- c) Check the lead is fitted between the display module and transducer.

### 2. Readings in First Peak mode are inconsistent.

Change First Peak sensitivity to be less sensitive, see SET-UP MENU section (page 4).

### 3. Required units of measurement are not selectable.

- a) Conversion from transducer standard units to required units could not be displayed within available digits on display, thus conversion is not allowed.
- b) Units required have not been enabled. See SET-UP MENU section (page 4).

### 4. RS-232-C data output not communicating with other equipment.

- a) Check that control word on the Pro-Test and the equipment receiving data match. See page 6.
- b) Check that the baud rate is set to 1200 baud on the equipment receiving data.
- c) Check that the connecting lead is wired correctly at both ends, see page 6.
- d) Check if equipment receiving data requires the units of measurement inhibited or a leading character. This is applicable when interfacing to Mitutoyo equipment, see page 7.

### 5. Display shows zero and does not alter when torque applied.

Switch power off or disconnect at the mains power socket, wait 2 seconds, then power up the Pro-Test again.

## PRO-TEST CALIBRATION AND REPAIR :- \_\_\_\_\_

To maintain the specified accuracy it is recommended that the Pro-Test transducers are recalibrated at least once per year.

Recalibration and repair should be carried out at Norbar or by a Norbar approved agent, where all the facilities to ensure the instrument is functioning at maximum accuracy are available.

Alternatively, procedures for calibrating the Pro-Test to the specified accuracy can be found in the Professional Torque Tester (Pro-Test) service manual Part No. 34240.

## CLEANING :- \_\_\_\_\_

Do not use abrasives or solvent based cleaners. We recommend a propriety brand of foam based fabric / vinyl cleaner. Use a soft cloth to avoid scratches.