

PROTECTION STANDARDS  
APPLICABLE TO AUTOMOBILES

A. Bremond

**1 - INTRODUCTION :**

A growing number of sensitive electronic units can be found in motor vehicles. Unfortunately the presence of electrical disturbances threatens their reliability.

The objective of this paper is to list all these disruptive factors and to suggest appropriate protection devices.

**Figure 1 :** Electronic modules in a car

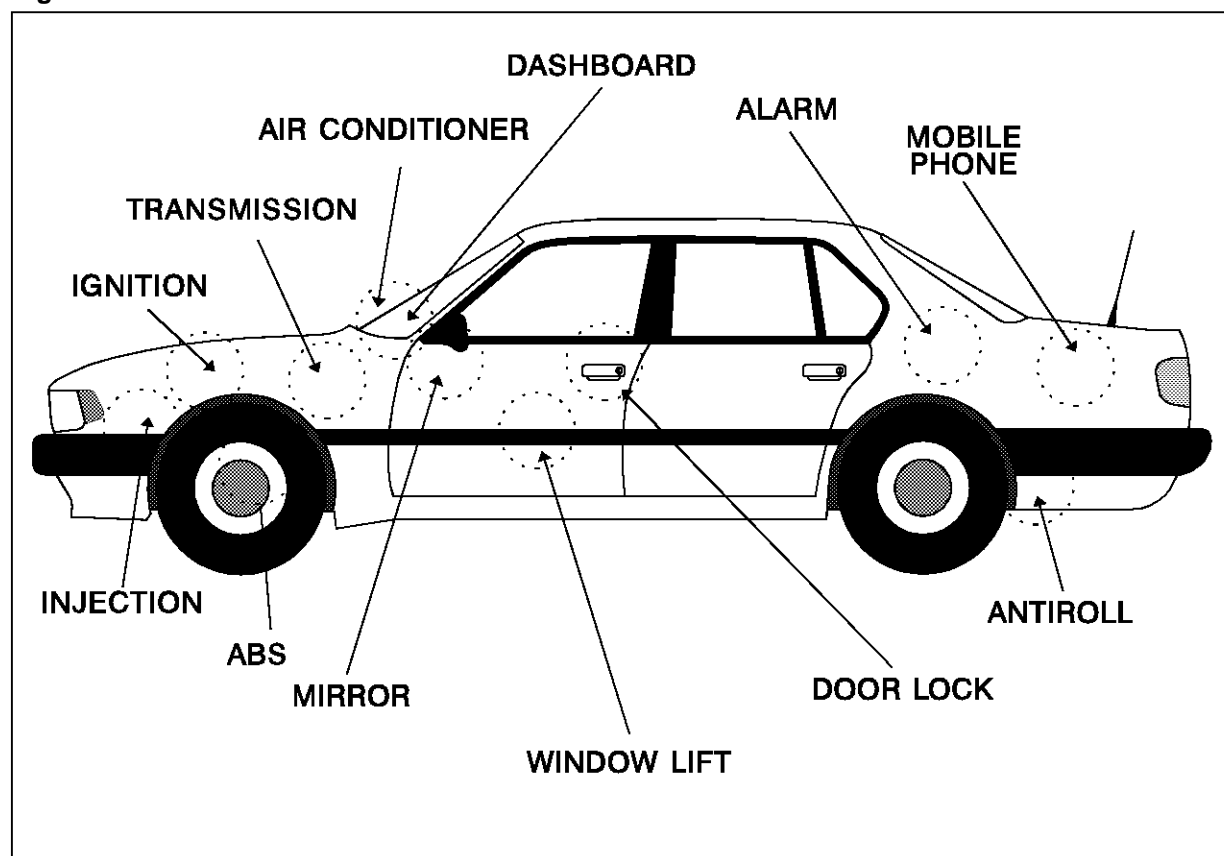

**II - GENERAL INFORMATION :**

**II.1** Simplified diagram of an automotive electrical circuit

**II.2** Coexistence of electromechanical engineering with electronics :

Fig. 2 shows that the electrical system of a motor vehicle contains some electromechanical engineering which generates disturbances (alternator, ignition system, starter, relays etc...)

and some electronic equipment affected by these disturbances (instrument computer, injection unit etc...). The role of the protection devices will be to ensure the smooth coexistence of both.

**Figure 2 :** Automotive electrical diagram

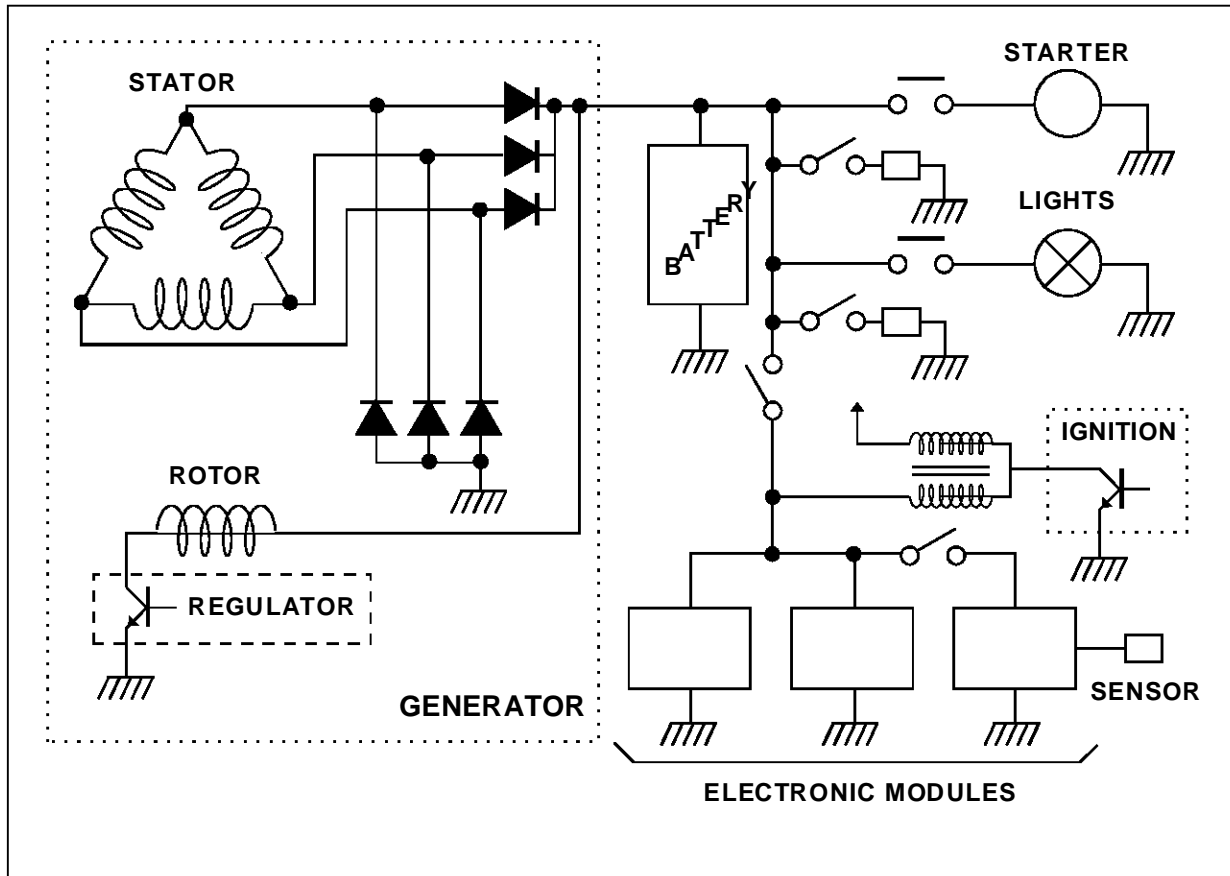

**III - ORIGIN AND WAVEFORM PARAMETERS :**

Electronic units receive the disturbances through the various cables which are connected to them. They are defined by the ISO/TC 22 standards and described in appropriate technical notes issued by the various motor vehicle manufacturers.

**III.1 Disconnecting inductive loads :**

Disconnecting an inductive element causes a high inverted overvoltage on its terminals.

**Figure 3 :** Shape of test pulse 1 (disconnection of Inductive Loads)

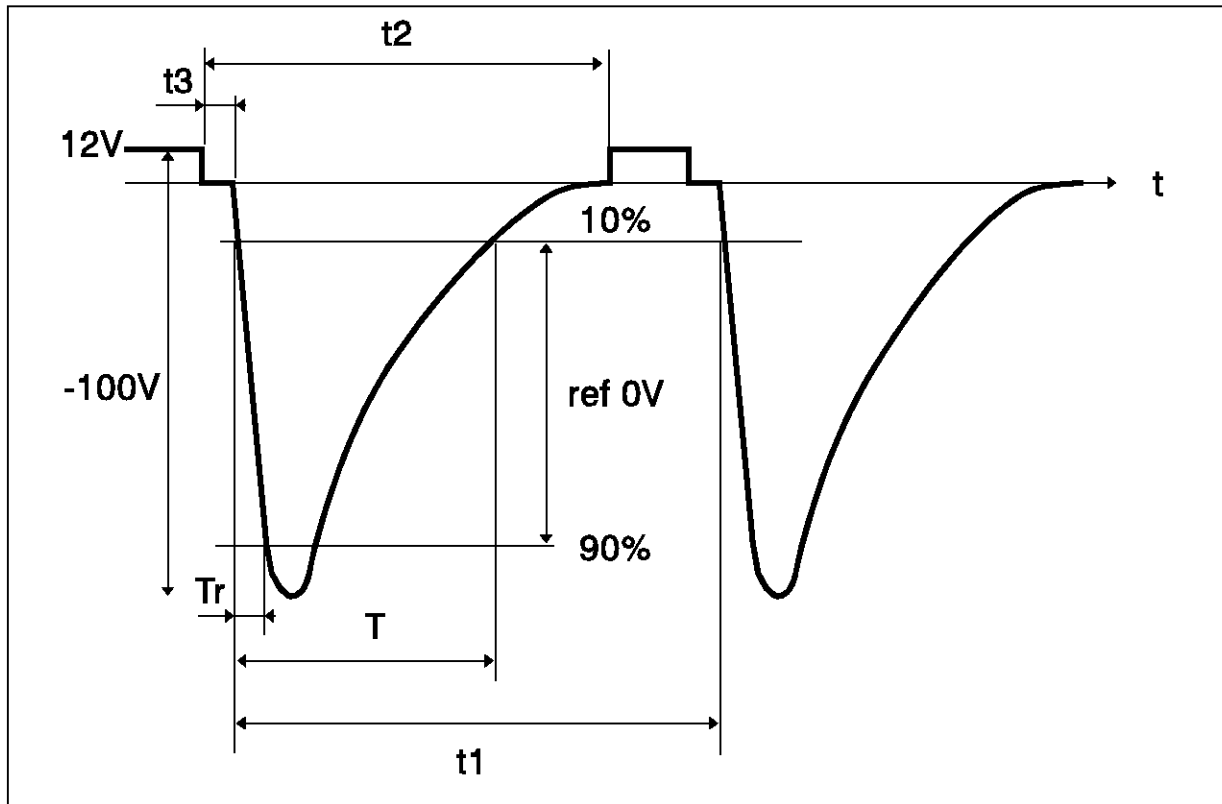

$T = 2$  milliseconds

$Tr = 1$  microsecond

$Ri = 10$  ohms \*

$t1 = 5$  seconds

$t2 = 0.2$  second

$t3 < 100 \mu s$

\* Internal series resistor of the surge generator.

## APPLICATION NOTE

### III.2 Sudden power cut off in the main circuit :

After the battery supply circuit is cut by the ignition key, the ignition circuit continues to release disturbances until the engine stops rotating.

Overvoltages are generated by switching the power supplied by electric motors acting as generators, e.g. the air conditioning fan. Their amplitude is increased by the absence of the filtering which would normally be carried out by the battery.

**Figure 4** : Shape of test pulse 2 (Sudden Interruption of Series Current)

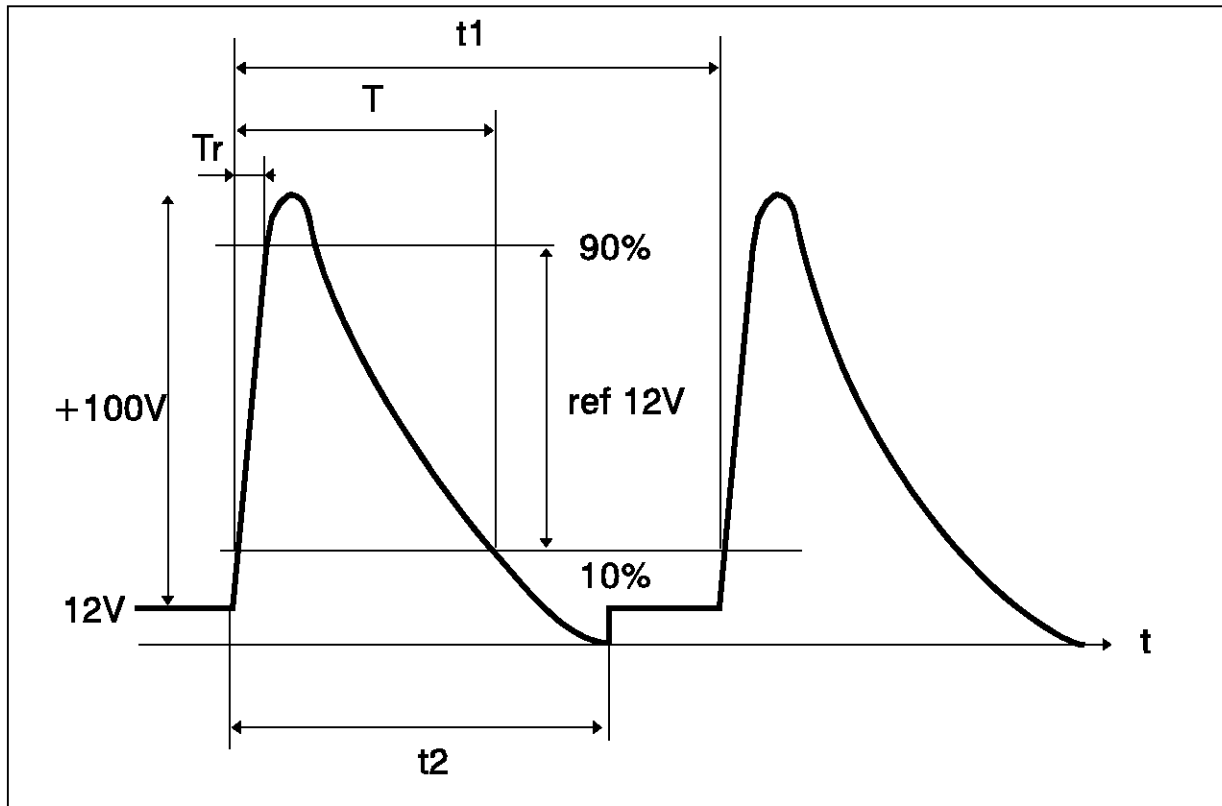

$$T = 2 \text{ milliseconds}$$

$$T_r = 1 \text{ microsecond}$$

$$R_i = 10 \text{ ohms}$$

$$t_1 = 0.5 \text{ to } 5 \text{ seconds}$$

$$t_2 = 0.2 \text{ second}$$

III.3. Switch bounce :

Power cut-off in the supply network capacitances and inductances, resulting from switch rebounds, generates sets of disturbances.

Figure 5A : Shape of test pulse 3A (switching spikes)

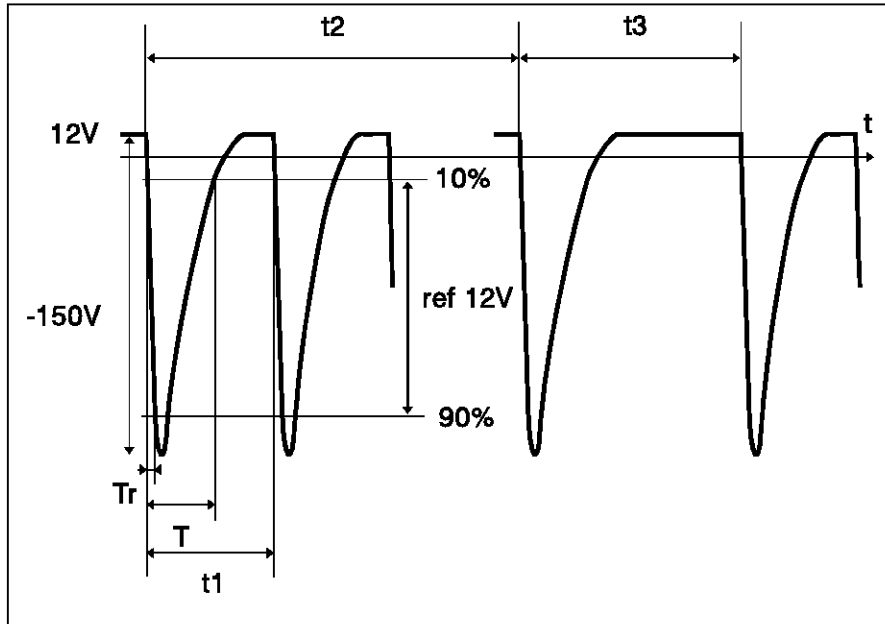

$T = 0.1$  microsecond  
 $T_r = 5$  nanoseconds  
 $R_i = 50$  ohms  
 $t_1 = 100$  microseconds  
 $t_2 = 10$  milliseconds  
 $t_3 = 90$  milliseconds

Figure 5B : Shape of test pulse 3B (switching spikes)

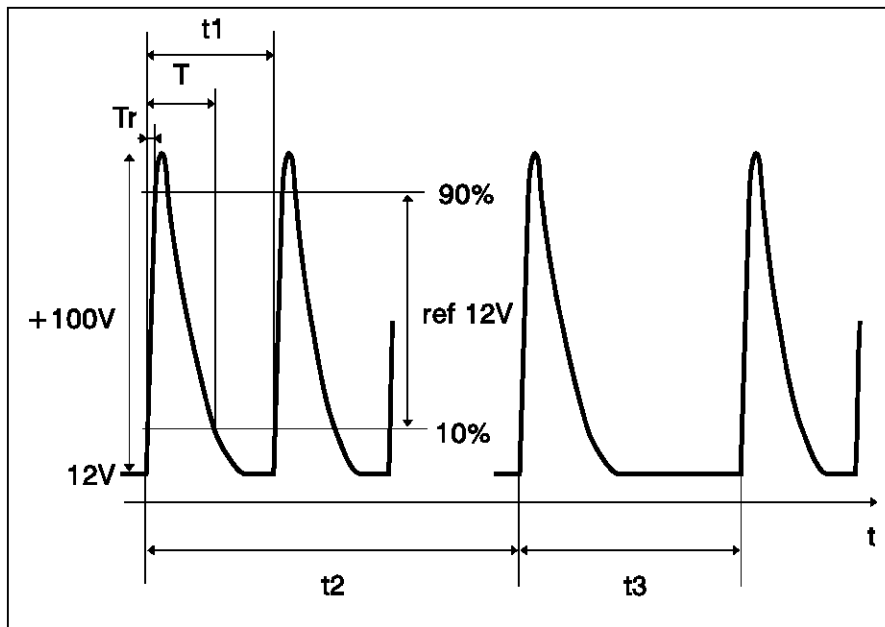

$T = 0.1$  microsecond  
 $T_r = 5$  nanoseconds  
 $R_i = 50$  ohms  
 $t_1 = 100$  microseconds  
 $t_2 = 10$  milliseconds  
 $t_3 = 90$  milliseconds

**III.4. Activating the starter :**

When the starter circuit is activated, a voltage drop occurs in the supply source.

**Figure 6 :** Shape of test pulse 4 (starter motor engagement disturbance)

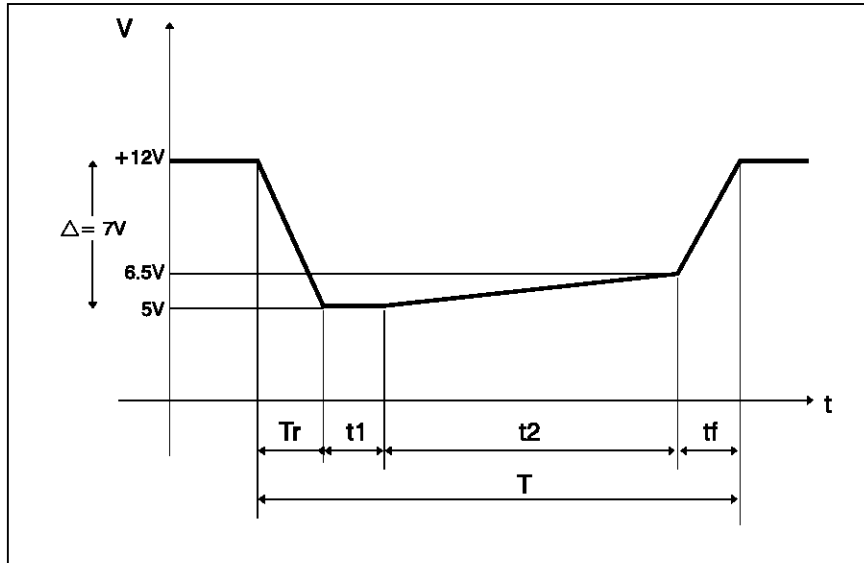

$T = 130$  milliseconds  
 $R_i = 0.01$  ohm  
 $T_r = 10$  milliseconds  
 $t_1 = 10$  milliseconds  
 $t_2 = 100$  milliseconds  
 $T_f = 10$  milliseconds

**III.5. Load dump :**

This happens when the battery is disconnected whilst being charged by the alternator.

During this load dump, the voltage on the alternator terminals increases rapidly. The length of this disturbance depends on the time constant of the generator excitation circuit.

**Figure 7 :** Shape of test pulse 5 (load dump)

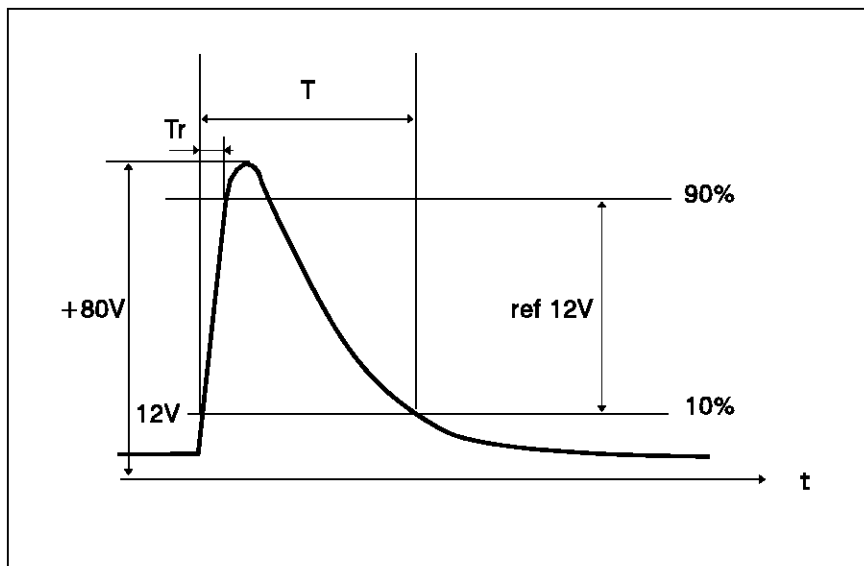

$T_r < 10$  milliseconds  
 $R_i = 2$  ohms  
 $T = 300$  ms

III.6. Power cut off in the ignition coil :

This disturbance occurs when the ignition contact is cut off.

Figure 8 : Shape of test pulse 6 (ignition coil current interruption)

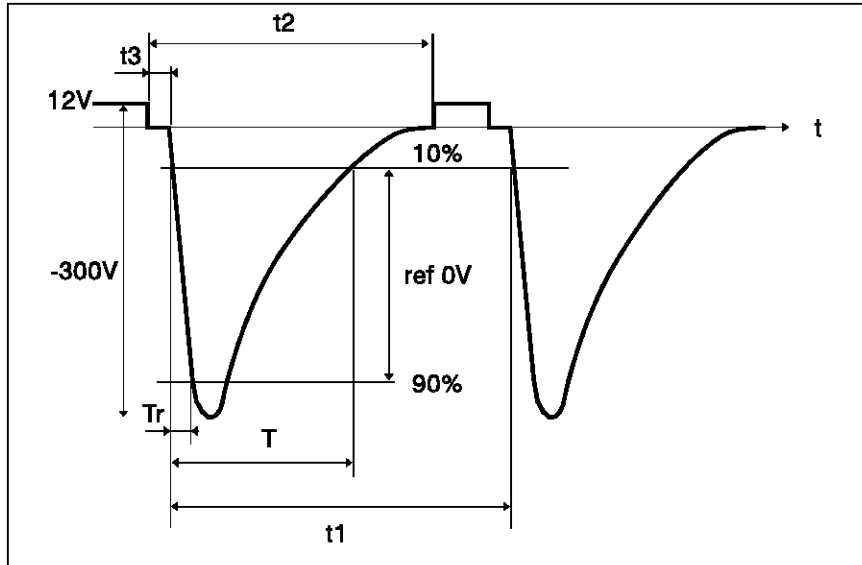

- T = 300 microseconds
- Tr = 60 microseconds
- Ri = 30 ohms
- t1 = 15 seconds
- t2 = 1 second
- t3 < 100 microseconds

III.7. Alternator magnetic field decay :

This negative overvoltage appears when the magnetic field of the alternator disappears (when the engine stops turning).

Figure 9 : Shape of test pulse 7 (alternator field transient at engine stop)

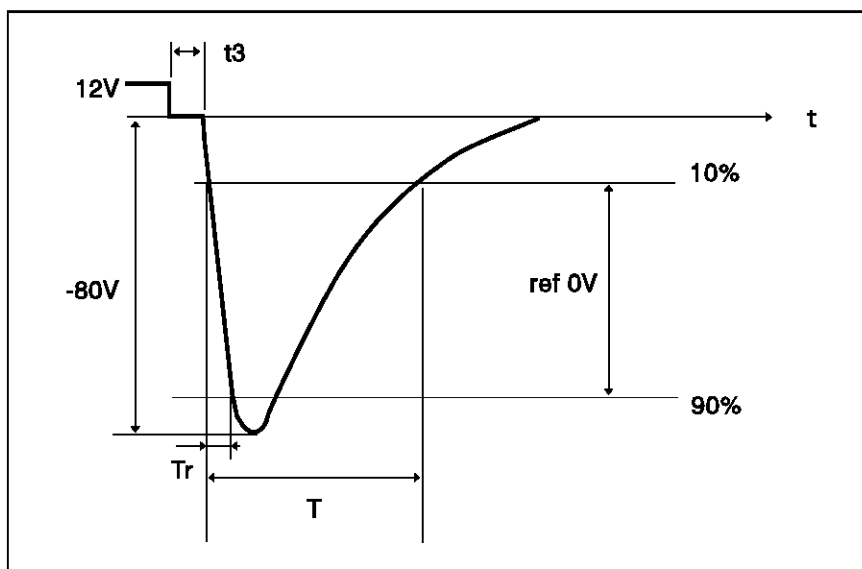

- T = 100 milliseconds
- Tr = 5 to 10 milliseconds
- Ri = 10 ohms
- t3 < 100 microseconds

## APPLICATION NOTE

### III.8. Regulator failure :

This type of problem can cause the output generated to be permanently too high, perhaps greater than 18 V.

### III.9. Starting aid :

In certain cases, when new motor vehicles have been stored over a long period (eg. sea deliveries, when starting takes place at low temperatures, etc...,) using another source of energy other than that of the vehicle becomes necessary.

The most common procedure is the use of two standard 12 Volt batteries paralleled with that of the vehicle. The overvoltage estimate is 24 Volts (or -24V in the case of an inverted connection).

### III.10. Miscellaneous :

Motor vehicles can be subject to other sources of disturbances, such as :

- the connection to a diagnostic unit.
- electric soldering.
- paint electrostatic tension.
- HF rays generated by transmission equipment.

## IV - ANALYSIS OF THE VARIOUS DISTURBANCES :

ORIGIN	DURATION	VOLTAGE	ENERGY	FREQUENCY
Disconnection of inductive loads	2 ms	- 100 V	2.3 j	Frequent
Power cut-off in the main circuit	2 ms	+ 100 V	2.3 j	Frequent
Switch bounce	0.1s x 10	+ 100 V - 150 V	50j x 10	Frequent
Starter engagement	130 ms	-	-	At every start
Load dump	300 ms	+ 80 V	50 j	rare
Ignition	300 s	- 300 V	0.003j	Frequent
Alternator magnetic field decay	100 ms	- 80 V	0.2 j	At every stop
Imperfections at regulator level	Continuous	+ 18 V	-	rare
Starting aid	Several minutes	24 V	-	rare

## V - CONCLUSION

Table IV shows that we are confronted with 5 types of disturbances :

- a/ Positive impulsive overvoltages
- b/ Negative impulsive overvoltages

c/ Positive continuous overvoltages

d/ Negative continuous overvoltages

e/ Impulsive voltage drop

The goal of protection circuits is to prevent destruction due to these disturbances.



Information furnished is believed to be accurate and reliable. However, SGS-THOMSON Microelectronics assumes no responsibility for the consequences of use of such information nor for any infringement of patents or other rights of third parties which may result from its use. No license is granted by implication or otherwise under any patent or patent rights of SGS-THOMSON Microelectronics. Specifications mentioned in this publication are subject to change without notice. This publication supersedes and replaces all information previously supplied.

SGS-THOMSON Microelectronics products are not authorized for use as critical components in life support devices or systems without express written approval of SGS-THOMSON Microelectronics.

© 1995 SGS-THOMSON Microelectronics - Printed in Italy - All rights reserved.

SGS-THOMSON Microelectronics GROUP OF COMPANIES

Australia - Brazil - France - Germany - Hong Kong - Italy - Japan - Korea - Malaysia - Malta - Morocco  
The Netherlands - Singapore - Spain - Sweden - Switzerland - Taiwan - Thailand - United Kingdom - U.S.A.