

SHINDENGEN

Darlington Transistor

2SB1284
(TP10J10)

-10A PNP

OUTLINE DIMENSIONS

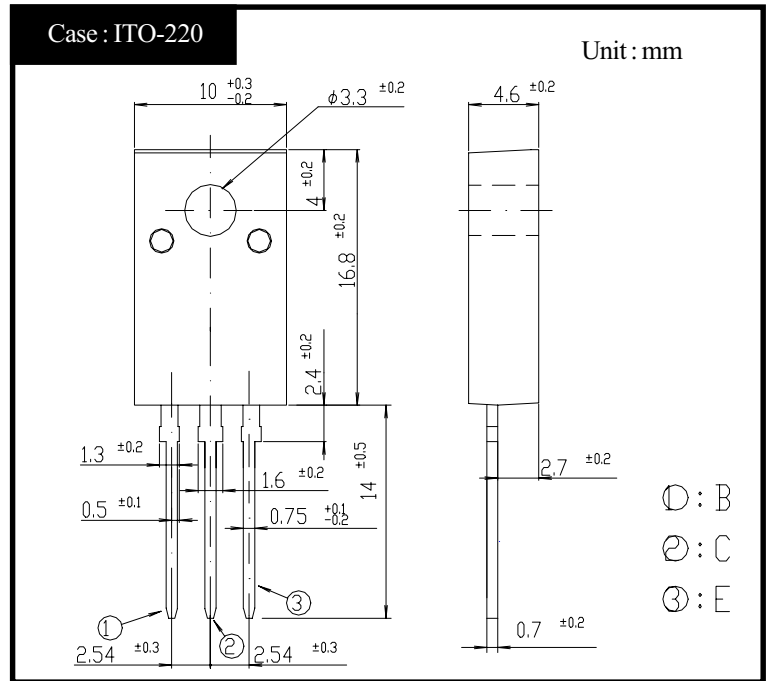

RATINGS

● Absolute Maximum Ratings

Item	Symbol	Conditions	Ratings	Unit
Storage Temperature	T_{stg}		-55~+150	°C
Junction Temperature	T_j		+150	°C
Collector to Base Voltage	V_{CBO}		-100	V
Collector to Emitter Voltage	V_{CEO}		-100	V
Emitter to Base Voltage	V_{EBO}		-7	V
Collector Current DC	I_C		-10	A
Collector Current Peak	I_{CP}		-15	A
Base Current DC	I_B		-0.8	A
Base Current Peak	I_{BP}		-1.5	A
Total Transistor Dissipation	P_T	$T_c = 25^\circ\text{C}$	35	W
Dielectric Strength	V_{dis}	Terminals to case AC 1 minute	2	kV
Mounting Torque	TOR	(Recommended torque : 0.3N·m)	0.5	N·m

● Electrical Characteristics ($T_c=25^\circ\text{C}$)

Item	Symbol	Conditions	Ratings	Unit
Collector Cutoff Current	I_{CBO}	$V_{CB} = -100\text{V}$	Max -0.1	mA
	I_{CEO}	$V_{CE} = -100\text{V}$	Max -0.1	
Emitter Cutoff Current	I_{EBO}	$V_{EB} = -7\text{V}$	Max -5	mA
DC Current Gain	h_{FE}	$V_{CE} = -3\text{V}, I_C = -5\text{A}$	Min 1,500	
			Max 15,000	
Collector to Emitter Saturation Voltage	$V_{CE(sat)}$	$I_C = -5\text{A}$	Max -1.5	V
Base to Emitter Saturation Voltage	$V_{BE(sat)}$	$I_B = -10\text{mA}$	Max -2.0	V
Thermal Resistance	θ_{jc}	Junction to case	Max 3.57	°C/W
Transition Frequency	f_T	$V_{CE} = 10\text{V}, I_C = -1\text{A}$	TYP 20	MHz
Turn on Time	t_{on}	$I_C = -5\text{A}$ $I_{B1} = I_{B2} = -10\text{mA}$ $R_L = 6\Omega$	Max 1	μs
Storage Time	t_s		Max 4	
Fall Time	t_f		Max 2	

2SB1284 Saturation Voltage

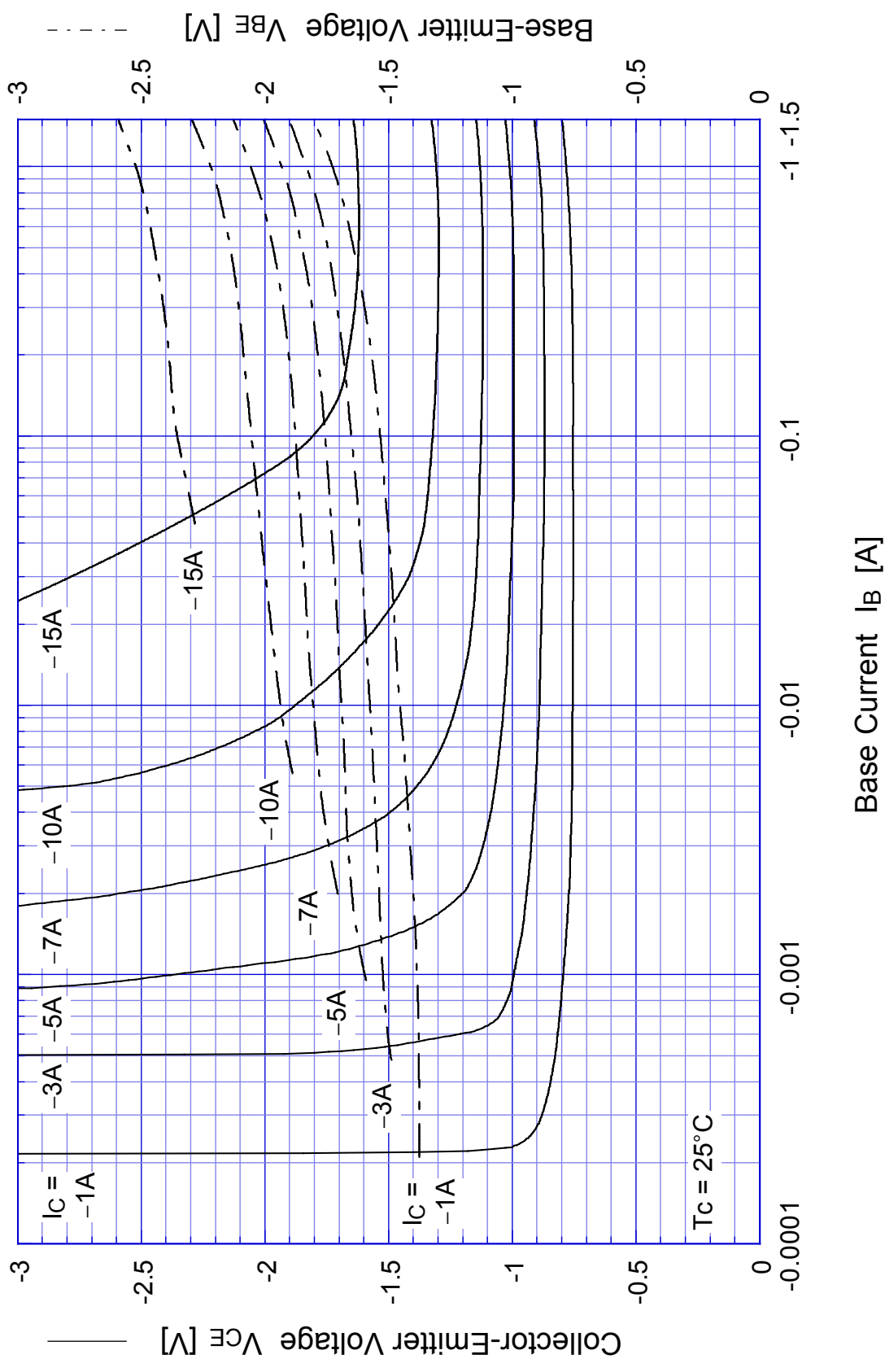

2SB1284

Switching Time - I_C

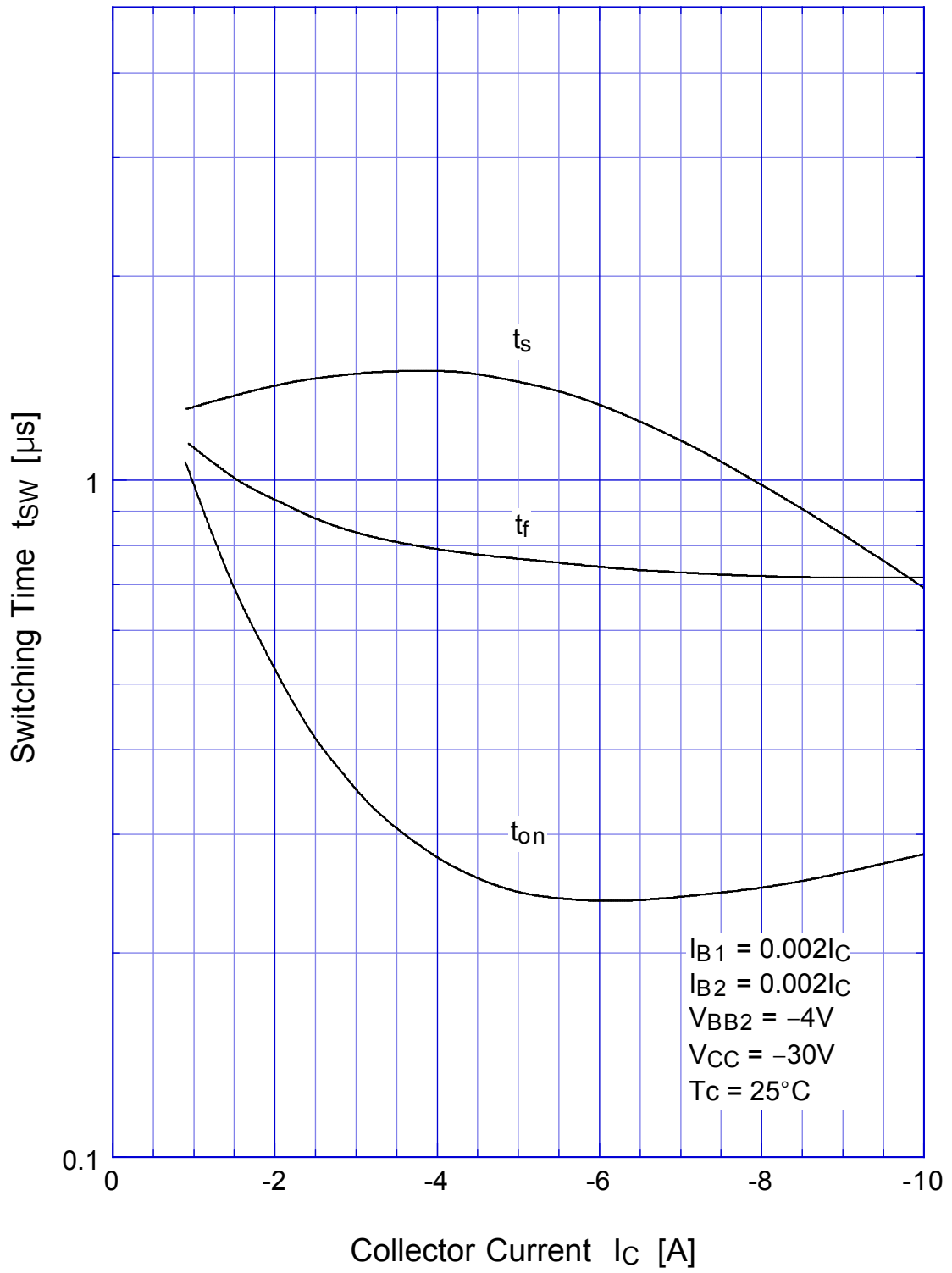

2SB1284

Switching Time - Tc

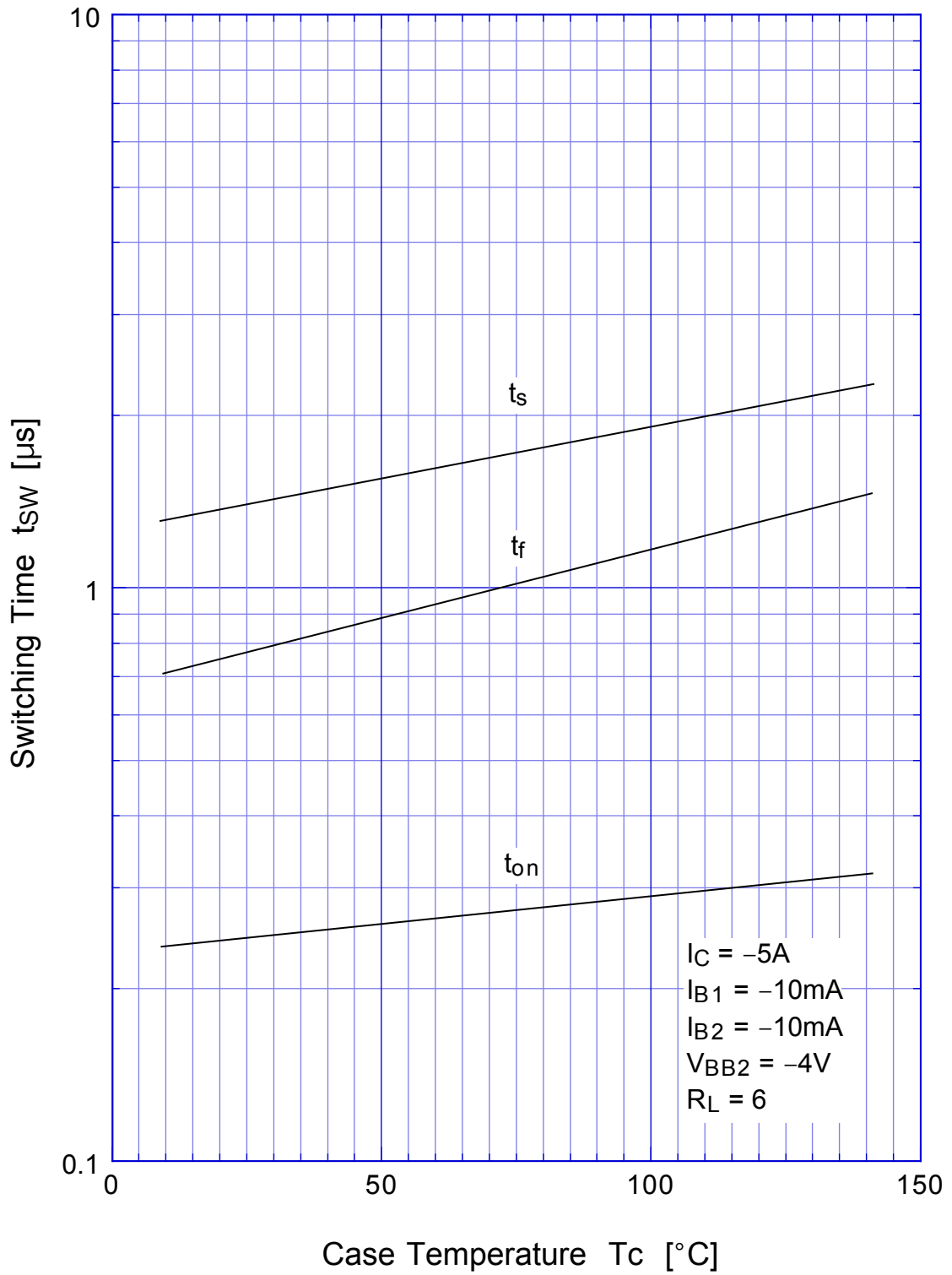

2SB1284 Transient Thermal Impedance

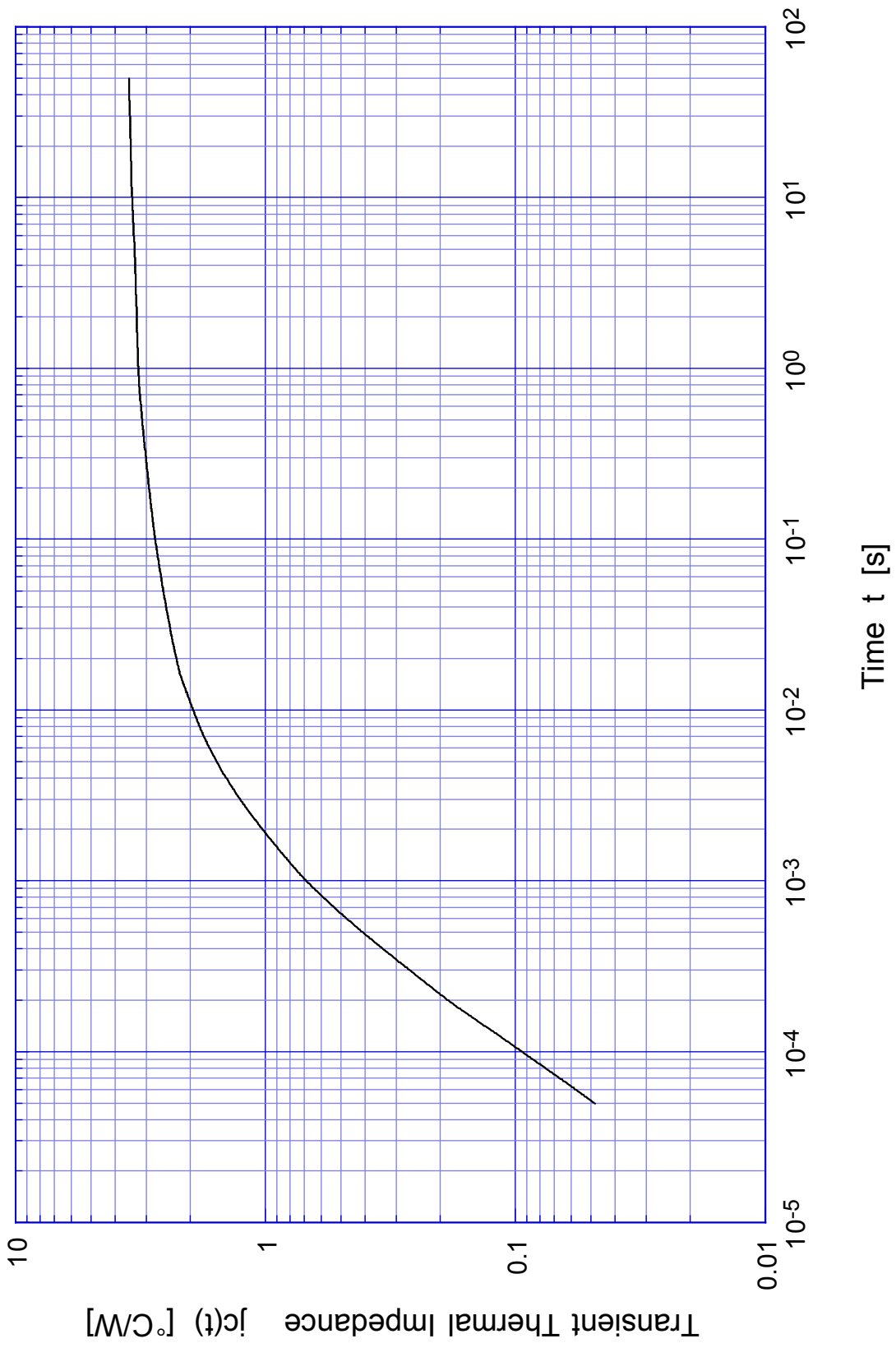

2SB1284

Forward Bias SOA

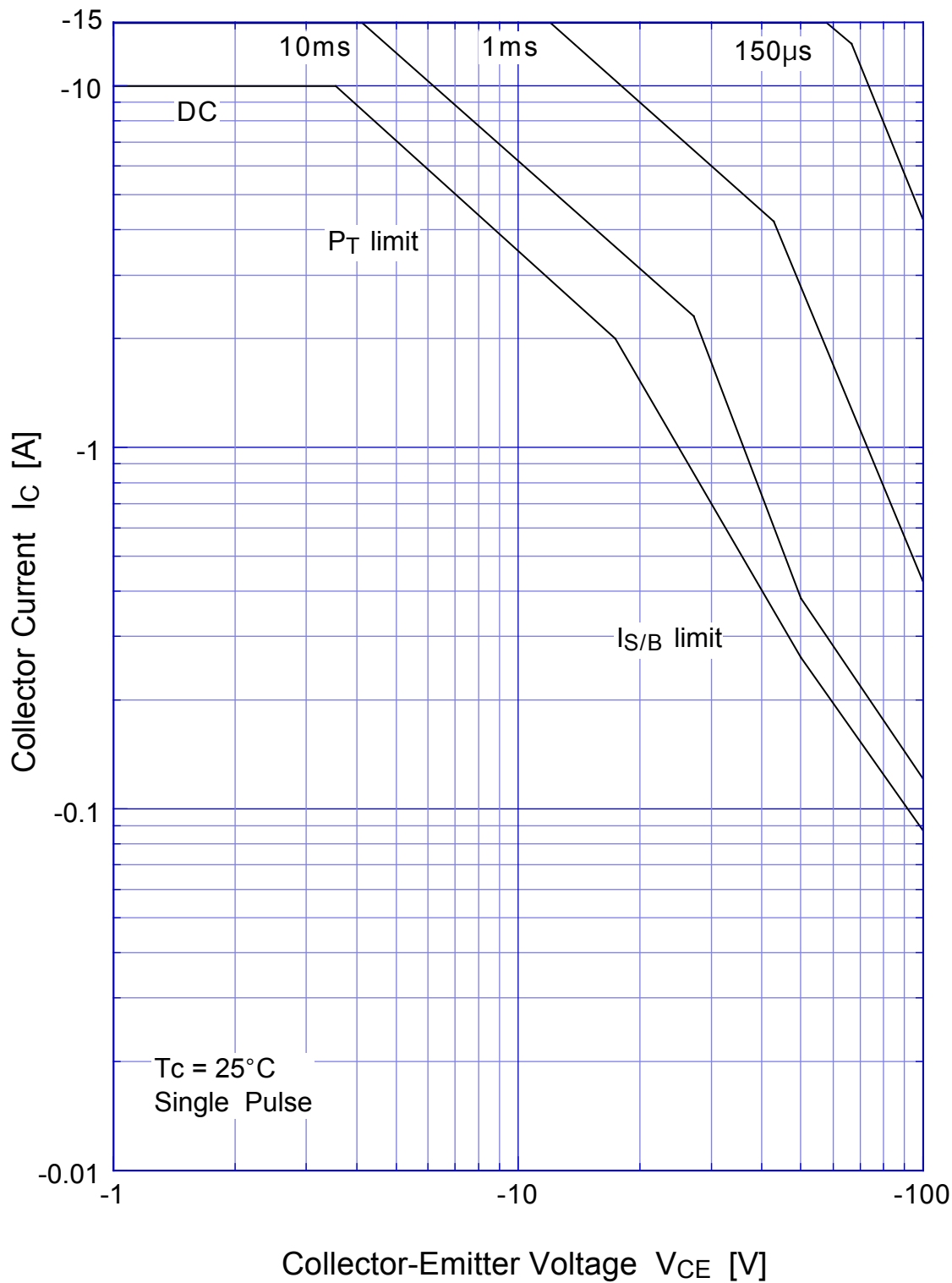

2SB1284 Collector Current Derating

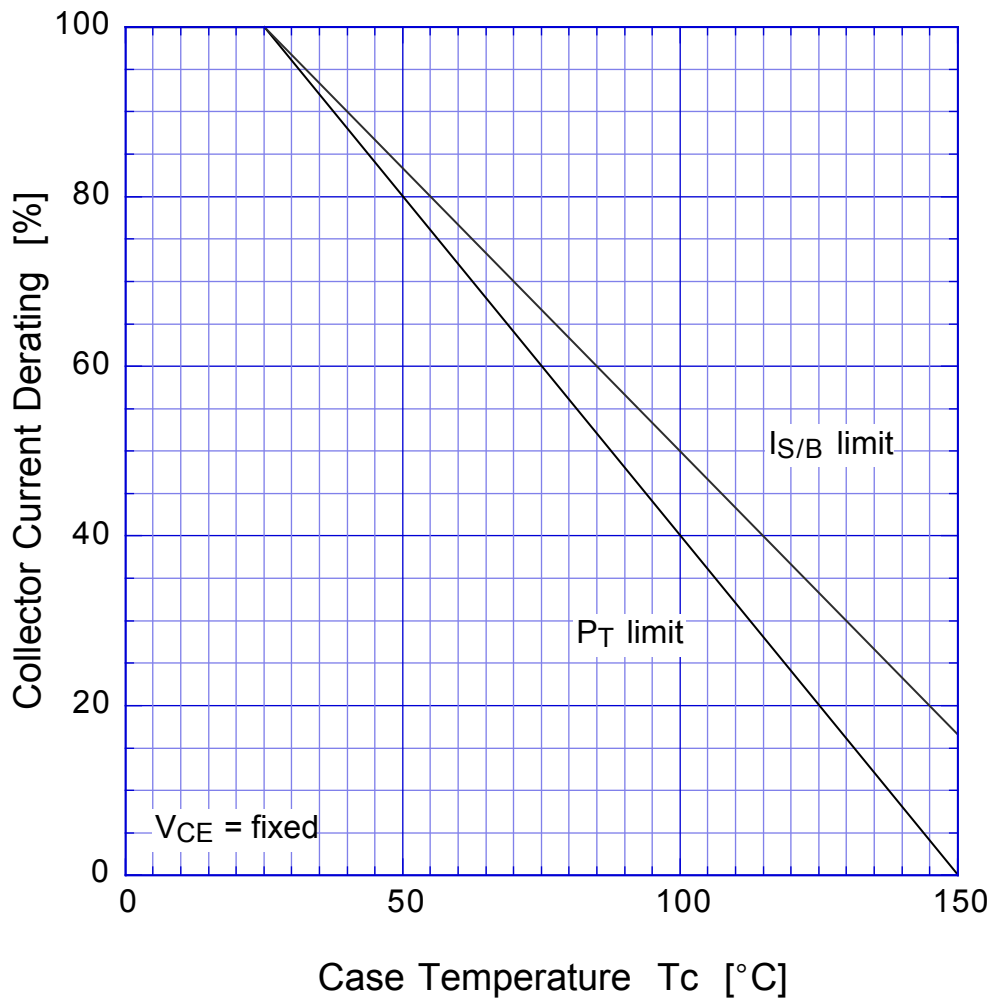

2SB1284

Reverse Bias SOA

