



**LUMINARY** MICRO™

---

# LM3S628 Microcontroller

**DATA SHEET**

---

## Legal Disclaimers and Trademark Information

INFORMATION IN THIS DOCUMENT IS PROVIDED IN CONNECTION WITH LUMINARY MICRO PRODUCTS. NO LICENSE, EXPRESS OR IMPLIED, BY ESTOPPEL OR OTHERWISE, TO ANY INTELLECTUAL PROPERTY RIGHTS IS GRANTED BY THIS DOCUMENT. EXCEPT AS PROVIDED IN LUMINARY MICRO'S TERMS AND CONDITIONS OF SALE FOR SUCH PRODUCTS, LUMINARY MICRO ASSUMES NO LIABILITY WHATSOEVER, AND LUMINARY MICRO DISCLAIMS ANY EXPRESS OR IMPLIED WARRANTY, RELATING TO SALE AND/OR USE OF LUMINARY MICRO'S PRODUCTS INCLUDING LIABILITY OR WARRANTIES RELATING TO FITNESS FOR A PARTICULAR PURPOSE, MERCHANTABILITY, OR INFRINGEMENT OF ANY PATENT, COPYRIGHT OR OTHER INTELLECTUAL PROPERTY RIGHT. LUMINARY MICRO'S PRODUCTS ARE NOT INTENDED FOR USE IN MEDICAL, LIFE SAVING, OR LIFE-SUSTAINING APPLICATIONS.

Luminary Micro may make changes to specifications and product descriptions at any time, without notice. Contact your local Luminary Micro sales office or your distributor to obtain the latest specifications before placing your product order.

Designers must not rely on the absence or characteristics of any features or instructions marked "reserved" or "undefined." Luminary Micro reserves these for future definition and shall have no responsibility whatsoever for conflicts or incompatibilities arising from future changes to them.

Copyright © 2006 Luminary Micro, Inc. All rights reserved. Stellaris and the Luminary Micro logo are trademarks of Luminary Micro, Inc. or its subsidiaries in the United States and other countries. ARM and Thumb are registered trademarks, and Cortex is a trademark of ARM Limited. Other names and brands may be claimed as the property of others.

Luminary Micro, Inc.  
2499 South Capital of Texas Hwy, Suite A-100  
Austin, TX 78746  
Main: +1-512-279-8800  
Fax: +1-512-279-8879  
<http://www.luminarymicro.com>



LUMINARY MICRO



## Table of Contents

|  |           |
|--|-----------|
| <b>Legal Disclaimers and Trademark Information</b> ..... | <b>2</b>  |
| <b>Revision History</b> .....                            | <b>15</b> |
| <b>About This Document</b> .....                         | <b>16</b> |
| Audience.....  | 16        |
| About This Manual.....                                   | 16        |
| Related Documents .....                                  | 16        |
| Documentation Conventions.....                           | 16        |
| <b>1. Architectural Overview</b> .....                   | <b>19</b> |
| 1.1 Product Features .....                               | 19        |
| 1.2 Target Applications .....                            | 22        |
| 1.3 High-Level Block Diagram .....                       | 23        |
| 1.4 Functional Overview .....                            | 24        |
| 1.4.1 ARM Cortex™-M3 .....                               | 24        |
| 1.4.2 Motor Control Peripherals.....                     | 24        |
| 1.4.3 Analog Peripherals .....                           | 24        |
| 1.4.4 Serial Communications Peripherals.....             | 25        |
| 1.4.5 System Peripherals.....                            | 26        |
| 1.4.6 Memory Peripherals.....                            | 26        |
| 1.4.7 Additional Features.....                           | 27        |
| 1.4.8 Hardware Details .....                             | 28        |
| 1.5 System Block Diagram .....                           | 29        |
| <b>2. ARM Cortex-M3 Processor Core</b> .....             | <b>30</b> |
| 2.1 Block Diagram .....                                  | 31        |
| 2.2 Functional Description .....                         | 31        |
| 2.2.1 Serial Wire and JTAG Debug .....                   | 31        |
| 2.2.2 Embedded Trace Macrocell (ETM).....                | 32        |
| 2.2.3 Trace Port Interface Unit (TPIU) .....             | 32        |
| 2.2.4 ROM Table .....                                    | 32        |
| 2.2.5 Memory Protection Unit (MPU).....                  | 32        |
| 2.2.6 Nested Vectored Interrupt Controller (NVIC) .....  | 32        |
| <b>3. Memory Map</b> .....                               | <b>33</b> |
| <b>4. Interrupts</b> .....                               | <b>35</b> |
| <b>5. JTAG Interface</b> .....                           | <b>38</b> |
| 5.1 Block Diagram .....                                  | 39        |
| 5.2 Functional Description .....                         | 39        |
| 5.2.1 JTAG Interface Pins.....                           | 40        |
| 5.2.2 JTAG TAP Controller .....                          | 41        |
| 5.2.3 Shift Registers .....                              | 42        |
| 5.2.4 Operational Considerations .....                   | 42        |
| 5.3 Initialization and Configuration.....                | 43        |
| 5.4 Register Descriptions.....                           | 44        |
| 5.4.1 Instruction Register (IR).....                     | 44        |
| 5.4.2 Data Registers .....                               | 46        |
| <b>6. System Control</b> .....                           | <b>48</b> |
| 6.1 Functional Description .....                         | 48        |
| 6.1.1 Device Identification.....                         | 48        |

|            |  |            |
|------------|--|------------|
| 6.1.2      | Reset Control .....                                | 48         |
| 6.1.3      | Power Control .....                                | 51         |
| 6.1.4      | Clock Control .....                                | 51         |
| 6.1.5      | System Control .....                               | 53         |
| 6.2        | Initialization and Configuration.....              | 54         |
| 6.3        | Register Map .....                                 | 54         |
| 6.4        | Register Descriptions.....                         | 55         |
| <b>7.</b>  | <b>Internal Memory .....</b>                       | <b>88</b>  |
| 7.1        | Block Diagram .....                                | 88         |
| 7.2        | Functional Description .....                       | 88         |
| 7.2.1      | SRAM Memory .....                                  | 88         |
| 7.2.2      | Flash Memory .....                                 | 89         |
| 7.3        | Initialization and Configuration.....              | 90         |
| 7.3.1      | Changing Flash Protection Bits .....               | 90         |
| 7.3.2      | Flash Programming .....                            | 91         |
| 7.4        | Register Map .....                                 | 91         |
| 7.5        | Register Descriptions.....                         | 92         |
| <b>8.</b>  | <b>General-Purpose Input/Outputs (GPIOs) .....</b> | <b>102</b> |
| 8.1        | Block Diagram .....                                | 103        |
| 8.2        | Functional Description .....                       | 103        |
| 8.2.1      | Data Register Operation .....                      | 104        |
| 8.2.2      | Data Direction .....                               | 105        |
| 8.2.3      | Interrupt Operation.....                           | 105        |
| 8.2.4      | Mode Control .....                                 | 106        |
| 8.2.5      | Pad Configuration .....                            | 106        |
| 8.2.6      | Identification.....                                | 106        |
| 8.3        | Initialization and Configuration.....              | 106        |
| 8.4        | Register Map .....                                 | 108        |
| 8.5        | Register Descriptions.....                         | 109        |
| <b>9.</b>  | <b>General-Purpose Timers .....</b>                | <b>140</b> |
| 9.1        | Block Diagram .....                                | 141        |
| 9.2        | Functional Description .....                       | 141        |
| 9.2.1      | GPTM Reset Conditions .....                        | 141        |
| 9.2.2      | 32-Bit Timer Operating Modes.....                  | 141        |
| 9.2.3      | 16-Bit Timer Operating Modes.....                  | 143        |
| 9.3        | Initialization and Configuration.....              | 147        |
| 9.3.1      | 32-Bit One-Shot/Periodic Timer Mode.....           | 147        |
| 9.3.2      | 32-Bit Real-Time Clock (RTC) Mode .....            | 148        |
| 9.3.3      | 16-Bit One-Shot/Periodic Timer Mode.....           | 148        |
| 9.3.4      | 16-Bit Input Edge Count Mode .....                 | 148        |
| 9.3.5      | 16-Bit Input Edge Timing Mode .....                | 149        |
| 9.3.6      | 16-Bit PWM Mode.....                               | 149        |
| 9.4        | Register Map .....                                 | 150        |
| 9.5        | Register Descriptions.....                         | 151        |
| <b>10.</b> | <b>Watchdog Timer .....</b>                        | <b>172</b> |
| 10.1       | Block Diagram .....                                | 172        |
| 10.2       | Functional Description .....                       | 173        |
| 10.3       | Initialization and Configuration.....              | 173        |
| 10.4       | Register Map .....                                 | 173        |

---

|            |   |            |
|------------|---|------------|
| 10.5       | Register Descriptions.....  | 174        |
| <b>11.</b> | <b>Analog-to-Digital Converter (ADC).....</b>                     | <b>195</b> |
| 11.1       | Block Diagram .....   | 195        |
| 11.2       | Functional Description .....                                      | 196        |
| 11.2.1     | Sample Sequencers .....   | 196        |
| 11.2.2     | Module Control .....  | 197        |
| 11.2.3     | Hardware Sample Averaging Circuit.....                            | 197        |
| 11.2.4     | Analog-to-Digital Converter .....                                 | 197        |
| 11.2.5     | Test Modes .....  | 197        |
| 11.2.6     | Internal Temperature Sensor.....                                  | 198        |
| 11.3       | Initialization and Configuration.....                             | 198        |
| 11.3.1     | Module Initialization .....                                       | 198        |
| 11.3.2     | Sample Sequencer Configuration .....                              | 198        |
| 11.4       | Register Map .....  | 199        |
| 11.5       | Register Descriptions.....  | 200        |
| <b>12.</b> | <b>Universal Asynchronous Receivers/Transmitters (UARTs).....</b> | <b>225</b> |
| 12.1       | Block Diagram .....   | 226        |
| 12.2       | Functional Description .....                                      | 226        |
| 12.2.1     | Transmit/Receive Logic .....                                      | 226        |
| 12.2.2     | Baud-Rate Generation .....  | 227        |
| 12.2.3     | Data Transmission.....  | 228        |
| 12.2.4     | FIFO Operation .....  | 228        |
| 12.2.5     | Interrupts.....   | 228        |
| 12.2.6     | Loopback Operation .....  | 229        |
| 12.3       | Initialization and Configuration.....                             | 229        |
| 12.4       | Register Map .....  | 230        |
| 12.5       | Register Descriptions.....  | 231        |
| <b>13.</b> | <b>Synchronous Serial Interface (SSI) .....</b>                   | <b>261</b> |
| 13.1       | Block Diagram .....   | 261        |
| 13.2       | Functional Description .....                                      | 262        |
| 13.2.1     | Bit Rate Generation .....   | 262        |
| 13.2.2     | FIFO Operation .....  | 262        |
| 13.2.3     | Interrupts.....   | 262        |
| 13.2.4     | Frame Formats .....   | 263        |
| 13.3       | Initialization and Configuration.....                             | 270        |
| 13.4       | Register Map .....  | 271        |
| 13.5       | Register Descriptions.....  | 272        |
| <b>14.</b> | <b>Inter-Integrated Circuit (I2C) Interface .....</b>             | <b>296</b> |
| 14.1       | Block Diagram .....   | 296        |
| 14.2       | Functional Description .....                                      | 296        |
| 14.2.1     | I <sup>2</sup> C Bus Functional Overview.....                     | 297        |
| 14.2.2     | Available Speed Modes .....                                       | 304        |
| 14.3       | Initialization and Configuration.....                             | 305        |
| 14.4       | Register Map .....  | 306        |
| 14.5       | Register Descriptions (I2C Master).....                           | 306        |
| 14.6       | Register Descriptions (I2C Slave).....                            | 320        |

|   |  |            |
|---|--|------------|
| <b>15.</b>                                    | <b>Pin Diagram .....</b>                                   | <b>328</b> |
| <b>16.</b>                                    | <b>Signal Tables .....</b>                                 | <b>329</b> |
| <b>17.</b>                                    | <b>Operating Characteristics .....</b>                     | <b>337</b> |
| <b>18.</b>                                    | <b>Electrical Characteristics .....</b>                    | <b>338</b> |
| 18.1  | DC Characteristics .....                                   | 338        |
| 18.1.1  | Maximum Ratings .....                                      | 338        |
| 18.1.2  | Recommended DC Operating Conditions .....                  | 338        |
| 18.1.3  | On-Chip Low Drop-Out (LDO) Regulator Characteristics ..... | 339        |
| 18.1.4  | Power Specifications .....                                 | 340        |
| 18.1.5  | Flash Memory Characteristics .....                         | 340        |
| 18.2  | AC Characteristics .....                                   | 341        |
| 18.2.1  | Load Conditions .....                                      | 341        |
| 18.2.2  | Clocks .....   | 341        |
| 18.2.3  | Temperature Sensor .....                                   | 342        |
| 18.2.4  | Analog-to-Digital Converter .....                          | 342        |
| 18.2.5  | I <sup>2</sup> C .....                                     | 343        |
| 18.2.6  | Synchronous Serial Interface (SSI) .....                   | 344        |
| 18.2.7  | JTAG and Boundary Scan .....                               | 346        |
| 18.2.8  | General-Purpose I/O .....                                  | 348        |
| 18.2.9  | Reset .....  | 348        |
| <b>19.</b>                                    | <b>Package Information.....</b>                            | <b>351</b> |
| <b>Appendix A.</b>                            | <b>Serial Flash Loader .....</b>                           | <b>352</b> |
| A.1   | Interfaces .....   | 352        |
| A.1.1   | UART .....   | 352        |
| A.1.2   | SSI .....  | 352        |
| A.2   | Packet Handling.....                                       | 352        |
| A.2.1   | Packet Format .....  | 353        |
| A.2.2   | Sending Packets .....                                      | 353        |
| A.2.3   | Receiving Packets .....                                    | 353        |
| A.3   | Commands .....   | 353        |
| A.3.1   | COMMAND_PING (0x20).....                                   | 354        |
| A.3.2   | COMMAND_GET_STATUS (0x23) .....                            | 354        |
| A.3.3   | COMMAND_DOWNLOAD (0x21).....                               | 354        |
| A.3.4   | COMMAND_SEND_DATA (0x24) .....                             | 354        |
| A.3.5   | COMMAND_RUN (0x22).....                                    | 355        |
| A.3.6   | COMMAND_RESET (0x25).....                                  | 355        |
| <b>Ordering and Contact Information .....</b> | <b>356</b>   |            |
| Ordering Information .....                    | 356  |            |
| Development Kit .....                         | 356  |            |
| Company Information .....                     | 356  |            |
| Support Information .....                     | 357  |            |

## List of Figures

|               |   |           |
|---------------|---|-----------|
| Figure 1-1.   | Stellaris High-Level Block Diagram .....                                    | 23        |
| Figure 1-2.   | LM3S628 Controller System-Level Block Diagram .....                         | 29        |
| Figure 2-1.   | CPU Block Diagram .....   | 31        |
| Figure 2-2.   | TPIU Block Diagram .....  | 32        |
| Figure 5-1.   | JTAG Module Block Diagram .....   | 39        |
| Figure 5-2.   | Test Access Port State Machine .....  | 42        |
| Figure 5-3.   | IDCODE Register Format .....  | 46        |
| Figure 5-4.   | BYPASS Register Format .....  | 46        |
| Figure 5-5.   | Boundary Scan Register Format .....   | 47        |
| Figure 6-1.   | External Circuitry to Extend Reset .....                                    | 49        |
| Figure 6-2.   | Main Clock Tree .....   | <b>52</b> |
| Figure 7-1.   | Flash Block Diagram .....   | 88        |
| Figure 8-1.   | GPIO Module Block Diagram .....   | 103       |
| Figure 8-2.   | GPIO Port Block Diagram .....   | 104       |
| Figure 8-3.   | GPIO DATA Write Example .....   | 105       |
| Figure 8-4.   | GPIO DATA Read Example .....  | 105       |
| Figure 9-1.   | GPTM Module Block Diagram .....   | 141       |
| Figure 9-2.   | 16-Bit Input Edge Count Mode Example .....                                  | 145       |
| Figure 9-3.   | 16-Bit Input Edge Time Mode Example .....                                   | 146       |
| Figure 9-4.   | 16-Bit PWM Mode Example .....   | 147       |
| Figure 10-1.  | WDT Module Block Diagram .....  | 172       |
| Figure 11-1.  | ADC Module Block Diagram .....  | 195       |
| Figure 11-2.  | Internal Temperature Sensor Characteristic .....                            | 198       |
| Figure 12-1.  | UART Module Block Diagram .....   | 226       |
| Figure 12-2.  | UART Character Frame .....  | 227       |
| Figure 13-1.  | SSI Module Block Diagram .....  | 261       |
| Figure 13-2.  | TI Synchronous Serial Frame Format (Single Transfer) .....                  | 263       |
| Figure 13-3.  | TI Synchronous Serial Frame Format (Continuous Transfer) .....              | 264       |
| Figure 13-4.  | Freescale SPI Format (Single Transfer) with SPO=0 and SPH=0 .....           | 265       |
| Figure 13-5.  | Freescale SPI Format (Continuous Transfer) with SPO=0 and SPH=0 .....       | 265       |
| Figure 13-6.  | Freescale SPI Frame Format with SPO=0 and SPH=1 .....                       | 266       |
| Figure 13-7.  | Freescale SPI Frame Format (Single Transfer) with SPO=1 and SPH=0 .....     | 266       |
| Figure 13-8.  | Freescale SPI Frame Format (Continuous Transfer) with SPO=1 and SPH=0 ..... | 267       |
| Figure 13-9.  | Freescale SPI Frame Format with SPO=1 and SPH=1 .....                       | 267       |
| Figure 13-10. | MICROWIRE Frame Format (Single Frame) .....                                 | 268       |
| Figure 13-11. | MICROWIRE Frame Format (Continuous Transfer) .....                          | 269       |
| Figure 13-12. | MICROWIRE Frame Format, SSIFss Input Setup and Hold Requirements .....      | 270       |
| Figure 14-1.  | I <sup>2</sup> C Block Diagram .....  | 296       |
| Figure 14-2.  | I <sup>2</sup> C Bus Configuration .....                                    | 297       |
| Figure 14-3.  | Data Validity During Bit Transfer on the I <sup>2</sup> C Bus .....         | 297       |
| Figure 14-4.  | START and STOP Conditions .....   | 297       |
| Figure 14-5.  | Complete Data Transfer with a 7-Bit Address .....                           | 298       |
| Figure 14-6.  | R/S Bit in First Byte .....   | 299       |
| Figure 14-7.  | Master Single SEND .....  | 299       |
| Figure 14-8.  | Master Single RECEIVE .....   | 300       |
| Figure 14-9.  | Master Burst SEND .....   | 301       |

|  |     |
|--|-----|
| Figure 14-10. Master Burst RECEIVE .....   | 302 |
| Figure 14-11. Master Burst RECEIVE after Burst SEND.....                                       | 303 |
| Figure 14-12. Master Burst SEND after Burst RECEIVE.....                                       | 303 |
| Figure 14-13. Slave Command Sequence.....  | 304 |
| Figure 15-1. Pin Connection Diagram.....   | 328 |
| Figure 18-1. Load Conditions.....  | 341 |
| Figure 18-2. I <sup>2</sup> C Timing.....  | 343 |
| Figure 18-3. SSI Timing for TI Frame Format (FRF=01), Single Transfer Timing Measurement ..... | 344 |
| Figure 18-4. SSI Timing for MICROWIRE Frame Format (FRF=10), Single Transfer.....              | 345 |
| Figure 18-5. SSI Timing for SPI Frame Format (FRF=00), with SPH=1 .....                        | 345 |
| Figure 18-6. JTAG Test Clock Input Timing.....   | 347 |
| Figure 18-7. JTAG Test Access Port (TAP) Timing.....   | 347 |
| Figure 18-8. JTAG $\overline{\text{TRST}}$ Timing .....  | 347 |
| Figure 18-9. External Reset Timing ( $\overline{\text{RST}}$ ).....                            | 349 |
| Figure 18-10. Power-On Reset Timing .....  | 349 |
| Figure 18-11. Brown-Out Reset Timing .....   | 349 |
| Figure 18-12. Software Reset Timing .....  | 349 |
| Figure 18-13. Watchdog Reset Timing .....  | 350 |
| Figure 18-14. LDO Reset Timing .....   | 350 |
| Figure 19-1. 48-Pin LQFP Package.....  | 351 |



## List of Tables

|              |  |     |
|--------------|--|-----|
| Table 0-1.   | Documentation Conventions .....  | 16  |
| Table 3-1.   | Memory Map.....  | 33  |
| Table 4-1.   | Exception Types .....  | 35  |
| Table 4-2.   | Interrupts .....   | 36  |
| Table 5-1.   | JTAG Port Pins Reset State .....   | 40  |
| Table 5-2.   | JTAG Instruction Register Commands .....                                 | 44  |
| Table 6-1.   | System Control Register Map.....   | 54  |
| Table 6-2.   | VADJ to VOUT .....   | 66  |
| Table 6-3.   | PLL Mode Control.....  | 78  |
| Table 6-4.   | Default Crystal Field Values and PLL Programming .....                   | 78  |
| Table 7-1.   | Flash Protection Policy Combinations .....                               | 90  |
| Table 7-2.   | Flash Register Map .....   | 91  |
| Table 8-1.   | GPIO Pad Configuration Examples .....                                    | 107 |
| Table 8-2.   | GPIO Interrupt Configuration Example .....                               | 107 |
| Table 8-3.   | GPIO Register Map .....  | 108 |
| Table 9-1.   | 16-Bit Timer With Prescaler Configurations .....                         | 144 |
| Table 9-2.   | GPTM Register Map.....   | 150 |
| Table 10-1.  | WDT Register Map.....  | 173 |
| Table 11-1.  | Samples and FIFO Depth of Sequencers.....                                | 196 |
| Table 11-2.  | ADC Register Map.....  | 199 |
| Table 12-1.  | UART Register Map .....  | 230 |
| Table 13-1.  | SSI Register Map .....   | 271 |
| Table 14-1.  | Examples of I <sup>2</sup> C Master Timer Period versus Speed Mode ..... | 305 |
| Table 14-2.  | I <sup>2</sup> C Register Map .....                                      | 306 |
| Table 14-3.  | Write Field Decoding for I2CMCS[3:0] Field .....                         | 310 |
| Table 16-1.  | Signals by Pin Number .....  | 329 |
| Table 16-2.  | Signals by Signal Name .....   | 331 |
| Table 16-3.  | Signals by Function, Except for GPIO .....                               | 334 |
| Table 16-4.  | GPIO Pins and Alternate Functions.....                                   | 335 |
| Table 17-1.  | Temperature Characteristics .....  | 337 |
| Table 17-2.  | Thermal Characteristics.....   | 337 |
| Table 18-1.  | Maximum Ratings.....   | 338 |
| Table 18-2.  | Recommended DC Operating Conditions .....                                | 338 |
| Table 18-3.  | LDO Regulator Characteristics.....                                       | 339 |
| Table 18-4.  | Power Specifications .....   | 340 |
| Table 18-5.  | Flash Memory Characteristics.....  | 340 |
| Table 18-6.  | Phase Locked Loop (PLL) Characteristics .....                            | 341 |
| Table 18-7.  | Clock Characteristics.....   | 341 |
| Table 18-8.  | Temperature Sensor Characteristics.....                                  | 342 |
| Table 18-9.  | ADC Characteristics .....  | 342 |
| Table 18-10. | I <sup>2</sup> C Characteristics.....                                    | 343 |
| Table 18-11. | SSI Characteristics .....  | 344 |
| Table 18-12. | JTAG Characteristics.....  | 346 |
| Table 18-13. | GPIO Characteristics.....  | 348 |
| Table 18-14. | Reset Characteristics .....  | 348 |

## List of Registers

|   |            |
|---|------------|
| <b>System Control</b> .....   | <b>48</b>  |
| Register 1: Device Identification 0 (DID0), offset 0x000 .....                              | 56         |
| Register 2: Device Identification 1 (DID1), offset 0x004 .....                              | 57         |
| Register 3: Device Capabilities 0 (DC0), offset 0x008 .....                                 | 59         |
| Register 4: Device Capabilities 1 (DC1), offset 0x010 .....                                 | 60         |
| Register 5: Device Capabilities 2 (DC2), offset 0x014 .....                                 | 62         |
| Register 6: Device Capabilities 3 (DC3), offset 0x018 .....                                 | 63         |
| Register 7: Device Capabilities 4 (DC4), offset 0x01C .....                                 | 64         |
| Register 8: Power-On and Brown-Out Reset Control (PBORCTL), offset 0x030 .....              | 65         |
| Register 9: LDO Power Control (LDOPCTL), offset 0x034 .....                                 | 66         |
| Register 10: Software Reset Control 0 (SRCR0), offset 0x040 .....                           | 67         |
| Register 11: Software Reset Control 1 (SRCR1), offset 0x044 .....                           | 68         |
| Register 12: Software Reset Control 2 (SRCR2), offset 0x048 .....                           | 69         |
| Register 13: Raw Interrupt Status (RIS), offset 0x050 .....                                 | 70         |
| Register 14: Interrupt Mask Control (IMC), offset 0x054 .....                               | 71         |
| Register 15: Masked Interrupt Status and Clear (MISC), offset 0x058 .....                   | 73         |
| Register 16: Reset Cause (RESC), offset 0x05C .....   | 74         |
| Register 17: Run-Mode Clock Configuration (RCC), offset 0x060 .....                         | 75         |
| Register 18: XTAL to PLL Translation (PLLCFG), offset 0x064 .....                           | 79         |
| Register 19: Run-Mode Clock Gating Control 0 (RCGC0), offset 0x100 .....                    | 80         |
| Register 20: Sleep-Mode Clock Gating Control 0 (SCGC0), offset 0x110 .....                  | 80         |
| Register 21: Deep-Sleep-Mode Clock Gating Control 0 (DCGC0), offset 0x120 .....             | 80         |
| Register 22: Run-Mode Clock Gating Control 1 (RCGC1), offset 0x104 .....                    | 82         |
| Register 23: Sleep-Mode Clock Gating Control 1 (SCGC1), offset 0x114 .....                  | 82         |
| Register 24: Deep-Sleep-Mode Clock Gating Control 1 (DCGC1), offset 0x124 .....             | 82         |
| Register 25: Run-Mode Clock Gating Control 2 (RCGC2), offset 0x108 .....                    | 84         |
| Register 26: Sleep-Mode Clock Gating Control 2 (SCGC2), offset 0x118 .....                  | 84         |
| Register 27: Deep-Sleep-Mode Clock Gating Control 2 (DCGC2), offset 0x128 .....             | 84         |
| Register 28: Deep-Sleep Clock Configuration (DSLPCCLKCFG), offset 0x144 .....               | 85         |
| Register 29: Clock Verification Clear (CLKVCLR), offset 0x150 .....                         | 86         |
| Register 30: Allow Unregulated LDO to Reset the Part (LDOARST), offset 0x160 .....          | 87         |
| <b>Internal Memory</b> .....  | <b>88</b>  |
| Register 1: Flash Memory Protection Read Enable (FMPRE), offset 0x130 .....                 | 93         |
| Register 2: Flash Memory Protection Program Enable (FMPPE), offset 0x134 .....              | 93         |
| Register 3: USec Reload (USECRL), offset 0x140 .....  | 94         |
| Register 4: Flash Memory Address (FMA), offset 0x000 .....                                  | 95         |
| Register 5: Flash Memory Data (FMD), offset 0x004 .....                                     | 96         |
| Register 6: Flash Memory Control (FMC), offset 0x008 .....                                  | 97         |
| Register 7: Flash Controller Raw Interrupt Status (FCRIS), offset 0x00C .....               | 99         |
| Register 8: Flash Controller Interrupt Mask (FCIM), offset 0x010 .....                      | 100        |
| Register 9: Flash Controller Masked Interrupt Status and Clear (FCMISC), offset 0x014 ..... | 101        |
| <b>General-Purpose Input/Outputs (GPIOs)</b> .....  | <b>102</b> |
| Register 1: GPIO Data (GPIODATA), offset 0x000 .....  | 110        |
| Register 2: GPIO Direction (GPIODIR), offset 0x400 .....                                    | 111        |
| Register 3: GPIO Interrupt Sense (GPIOIS), offset 0x404 .....                               | 112        |
| Register 4: GPIO Interrupt Both Edges (GPIOIBE), offset 0x408 .....                         | 113        |

|                                     |   |            |
|-------------------------------------|---|------------|
| Register 5:                         | GPIO Interrupt Event (GPIOIEV), offset 0x40C.....                   | 114        |
| Register 6:                         | GPIO Interrupt Mask (GPIOIM), offset 0x410.....                     | 115        |
| Register 7:                         | GPIO Raw Interrupt Status (GPIORIS), offset 0x414.....              | 116        |
| Register 8:                         | GPIO Masked Interrupt Status (GPIOMIS), offset 0x418.....           | 117        |
| Register 9:                         | GPIO Interrupt Clear (GPIOICR), offset 0x41C.....                   | 118        |
| Register 10:                        | GPIO Alternate Function Select (GPIOAFSEL), offset 0x420.....       | 119        |
| Register 11:                        | GPIO 2-mA Drive Select (GPIODR2R), offset 0x500.....                | 120        |
| Register 12:                        | GPIO 4-mA Drive Select (GPIODR4R), offset 0x504.....                | 121        |
| Register 13:                        | GPIO 8-mA Drive Select (GPIODR8R), offset 0x508.....                | 122        |
| Register 14:                        | GPIO Open Drain Select (GPIODR), offset 0x50C.....                  | 123        |
| Register 15:                        | GPIO Pull-Up Select (GPIOPUR), offset 0x510.....                    | 124        |
| Register 16:                        | GPIO Pull-Down Select (GPIOPDR), offset 0x514.....                  | 125        |
| Register 17:                        | GPIO Slew Rate Control Select (GPIOSLR), offset 0x518.....          | 126        |
| Register 18:                        | GPIO Digital Input Enable (GPIODEN), offset 0x51C.....              | 127        |
| Register 19:                        | GPIO Peripheral Identification 4 (GPIOPeriphID4), offset 0xFD0..... | 128        |
| Register 20:                        | GPIO Peripheral Identification 5 (GPIOPeriphID5), offset 0xFD4..... | 129        |
| Register 21:                        | GPIO Peripheral Identification 6 (GPIOPeriphID6), offset 0xFD8..... | 130        |
| Register 22:                        | GPIO Peripheral Identification 7 (GPIOPeriphID7), offset 0xFDC..... | 131        |
| Register 23:                        | GPIO Peripheral Identification 0 (GPIOPeriphID0), offset 0xFE0..... | 132        |
| Register 24:                        | GPIO Peripheral Identification 1 (GPIOPeriphID1), offset 0xFE4..... | 133        |
| Register 25:                        | GPIO Peripheral Identification 2 (GPIOPeriphID2), offset 0xFE8..... | 134        |
| Register 26:                        | GPIO Peripheral Identification 3 (GPIOPeriphID3), offset 0xFEC..... | 135        |
| Register 27:                        | GPIO PrimeCell Identification 0 (GPIOCellID0), offset 0xFF0.....    | 136        |
| Register 28:                        | GPIO PrimeCell Identification 1 (GPIOCellID1), offset 0xFF4.....    | 137        |
| Register 29:                        | GPIO PrimeCell Identification 2 (GPIOCellID2), offset 0xFF8.....    | 138        |
| Register 30:                        | GPIO PrimeCell Identification 3 (GPIOCellID3), offset 0xFFC.....    | 139        |
| <b>General-Purpose Timers .....</b> |   | <b>140</b> |
| Register 1:                         | GPTM Configuration (GPTMCFG), offset 0x000.....                     | 152        |
| Register 2:                         | GPTM TimerA Mode (GPTMTAMR), offset 0x004.....                      | 153        |
| Register 3:                         | GPTM TimerB Mode (GPTMTBMR), offset 0x008.....                      | 154        |
| Register 4:                         | GPTM Control (GPTMCTL), offset 0x00C.....                           | 155        |
| Register 5:                         | GPTM Interrupt Mask (GPTMIMR), offset 0x018.....                    | 157        |
| Register 6:                         | GPTM Raw Interrupt Status (GPTMRIS), offset 0x01C.....              | 159        |
| Register 7:                         | GPTM Masked Interrupt Status (GPTMMIS), offset 0x020.....           | 160        |
| Register 8:                         | GPTM Interrupt Clear (GPTMICR), offset 0x024.....                   | 161        |
| Register 9:                         | GPTM TimerA Interval Load (GPTMTAILR), offset 0x028.....            | 162        |
| Register 10:                        | GPTM TimerB Interval Load (GPTMTBILR), offset 0x02C.....            | 163        |
| Register 11:                        | GPTM TimerA Match (GPTMTAMATCHR), offset 0x030.....                 | 164        |
| Register 12:                        | GPTM TimerB Match (GPTMTBMATCHR), offset 0x034.....                 | 165        |
| Register 13:                        | GPTM TimerA Prescale (GPTMTAPR), offset 0x038.....                  | 166        |
| Register 14:                        | GPTM TimerB Prescale (GPTMTBPR), offset 0x03C.....                  | 167        |
| Register 15:                        | GPTM TimerA Prescale Match (GPTMTAPMR), offset 0x040.....           | 168        |
| Register 16:                        | GPTM TimerB Prescale Match (GPTMTBPMR), offset 0x044.....           | 169        |
| Register 17:                        | GPTM TimerA (GPTMTAR), offset 0x048.....                            | 170        |
| Register 18:                        | GPTM TimerB (GPTMTBR), offset 0x04C.....                            | 171        |
| <b>Watchdog Timer.....</b>          |   | <b>172</b> |
| Register 1:                         | Watchdog Load (WDTLOAD), offset 0x000.....                          | 175        |
| Register 2:                         | Watchdog Value (WDTVALUE), offset 0x004.....                        | 176        |

|  |  |            |
|--|--|------------|
| Register 3:  | Watchdog Control (WDTCTL), offset 0x008 .....                                  | 177        |
| Register 4:  | Watchdog Interrupt Clear (WDTICR), offset 0x00C .....                          | 178        |
| Register 5:  | Watchdog Raw Interrupt Status (WDTRIS), offset 0x010 .....                     | 179        |
| Register 6:  | Watchdog Masked Interrupt Status (WDTMIS), offset 0x014.....                   | 180        |
| Register 7:  | Watchdog Lock (WDTLOCK), offset 0xC00 .....                                    | 181        |
| Register 8:  | Watchdog Test (WDTTEST), offset 0x418.....                                     | 182        |
| Register 9:  | Watchdog Peripheral Identification 4 (WDTPeriphID4), offset 0xFD0.....         | 183        |
| Register 10:   | Watchdog Peripheral Identification 5 (WDTPeriphID5), offset 0xFD4.....         | 184        |
| Register 11:   | Watchdog Peripheral Identification 6 (WDTPeriphID6), offset 0xFD8.....         | 185        |
| Register 12:   | Watchdog Peripheral Identification 7 (WDTPeriphID7), offset 0xFDC .....        | 186        |
| Register 13:   | Watchdog Peripheral Identification 0 (WDTPeriphID0), offset 0xFE0 .....        | 187        |
| Register 14:   | Watchdog Peripheral Identification 1 (WDTPeriphID1), offset 0xFE4.....         | 188        |
| Register 15:   | Watchdog Peripheral Identification 2 (WDTPeriphID2), offset 0xFE8.....         | 189        |
| Register 16:   | Watchdog Peripheral Identification 3 (WDTPeriphID3), offset 0xFEC .....        | 190        |
| Register 17:   | Watchdog PrimeCell Identification 0 (WDTPCellID0), offset 0xFF0.....           | 191        |
| Register 18:   | Watchdog PrimeCell Identification 1 (WDTPCellID1), offset 0xFF4.....           | 192        |
| Register 19:   | Watchdog PrimeCell Identification 2 (WDTPCellID2), offset 0xFF8.....           | 193        |
| Register 20:   | Watchdog PrimeCell Identification 3 (WDTPCellID3), offset 0xFFC .....          | 194        |
| <b>Analog-to-Digital Converter (ADC).....</b>                      |  | <b>195</b> |
| Register 1:  | ADC Active Sample Sequencer (ADCACTSS), offset 0x000 .....                     | 201        |
| Register 2:  | ADC Raw Interrupt Status (ADCRIS), offset 0x004.....                           | 202        |
| Register 3:  | ADC Interrupt Mask (ADCIM), offset 0x008 .....                                 | 203        |
| Register 4:  | ADC Interrupt Status and Clear (ADCISC), offset 0x00C.....                     | 204        |
| Register 5:  | ADC Overflow Status (ADCOSTAT), offset 0x010 .....                             | 205        |
| Register 6:  | ADC Event Multiplexer Select (ADCEMUX), offset 0x014 .....                     | 206        |
| Register 7:  | ADC Underflow Status (ADCUSTAT), offset 0x018 .....                            | 207        |
| Register 8:  | ADC Sample Sequencer Priority (ADCSSPRI), offset 0x020.....                    | 208        |
| Register 9:  | ADC Processor Sample Sequence Initiate (ADCPSSI), offset 0x028 .....           | 209        |
| Register 10:   | ADC Sample Averaging Control (ADCSAC), offset 0x030 .....                      | 210        |
| Register 11:   | ADC Sample Sequence Input Multiplexer Select 0 (ADCSSMUX0), offset 0x040.....  | 211        |
| Register 12:   | ADC Sample Sequence Control 0 (ADCSSCTL0), offset 0x044.....                   | 213        |
| Register 13:   | ADC Sample Sequence Result FIFO 0 (ADCSSFIFO0), offset 0x048.....              | 215        |
| Register 14:   | ADC Sample Sequence FIFO 0 Status (ADCSSFSTAT0), offset 0x04C.....             | 216        |
| Register 15:   | ADC Sample Sequence Input Multiplexer Select 1 (ADCSSMUX1), offset 0x060.....  | 217        |
| Register 16:   | ADC Sample Sequence Control 1 (ADCSSCTL1), offset 0x064.....                   | 218        |
| Register 17:   | ADC Sample Sequence Result FIFO 1 (ADCSSFIFO1), offset 0x068.....              | 218        |
| Register 18:   | ADC Sample Sequence FIFO 1 Status (ADCSSFSTAT1), offset 0x06C.....             | 218        |
| Register 19:   | ADC Sample Sequence Input Multiplexer Select 2 (ADCSSMUX2), offset 0x080.....  | 219        |
| Register 20:   | ADC Sample Sequence Control 2 (ADCSSCTL2), offset 0x084.....                   | 220        |
| Register 21:   | ADC Sample Sequence Result FIFO 2 (ADCSSFIFO2), offset 0x088.....              | 220        |
| Register 22:   | ADC Sample Sequence FIFO 2 Status (ADCSSFSTAT2), offset 0x08C.....             | 220        |
| Register 23:   | ADC Sample Sequence Input Multiplexer Select 3 (ADCSSMUX3), offset 0x0A0 ..... | 221        |
| Register 24:   | ADC Sample Sequence Control 3 (ADCSSCTL3), offset 0x064.....                   | 222        |
| Register 25:   | ADC Sample Sequence Result FIFO 3 (ADCSSFIFO3), offset 0x0A8 .....             | 222        |
| Register 26:   | ADC Sample Sequence FIFO 3 Status (ADCSSFSTAT3), offset 0x0AC .....            | 222        |
| Register 27:   | ADC Test Mode Loopback (ADCTMLB), offset 0x100 .....                           | 223        |
| <b>Universal Asynchronous Receivers/Transmitters (UARTs) .....</b> |  | <b>225</b> |
| Register 1:  | UART Data (UARTDR), offset 0x000 .....   | 232        |

|   |   |            |
|---|---|------------|
| Register 2:   | UART Receive Status/Error Clear (UARTRSR/UARTECR), offset 0x004 ..... | 234        |
| Register 3:   | UART Flag (UARTFR), offset 0x018 .....                                | 236        |
| Register 4:   | UART Integer Baud-Rate Divisor (UARTIBRD), offset 0x024 .....         | 238        |
| Register 5:   | UART Fractional Baud-Rate Divisor (UARTFBRD), offset 0x028 .....      | 239        |
| Register 6:   | UART Line Control (UARTLCRH), offset 0x02C .....                      | 240        |
| Register 7:   | UART Control (UARTCTL), offset 0x030.....                             | 242        |
| Register 8:   | UART Interrupt FIFO Level Select (UARTIFLS), offset 0x034 .....       | 243        |
| Register 9:   | UART Interrupt Mask (UARTIM), offset 0x038 .....                      | 244        |
| Register 10:  | UART Raw Interrupt Status (UARTRIS), offset 0x03C.....                | 246        |
| Register 11:  | UART Masked Interrupt Status (UARTMIS), offset 0x040 .....            | 247        |
| Register 12:  | UART Interrupt Clear (UARTICR), offset 0x044.....                     | 248        |
| Register 13:  | UART Peripheral Identification 4 (UARTPeriphID4), offset 0xFD0.....   | 249        |
| Register 14:  | UART Peripheral Identification 5 (UARTPeriphID5), offset 0xFD4.....   | 250        |
| Register 15:  | UART Peripheral Identification 6 (UARTPeriphID6), offset 0xFD8.....   | 251        |
| Register 16:  | UART Peripheral Identification 7 (UARTPeriphID7), offset 0xFDC .....  | 252        |
| Register 17:  | UART Peripheral Identification 0 (UARTPeriphID0), offset 0xFE0.....   | 253        |
| Register 18:  | UART Peripheral Identification 1 (UARTPeriphID1), offset 0xFE4.....   | 254        |
| Register 19:  | UART Peripheral Identification 2 (UARTPeriphID2), offset 0xFE8.....   | 255        |
| Register 20:  | UART Peripheral Identification 3 (UARTPeriphID3), offset 0xFEC .....  | 256        |
| Register 21:  | UART PrimeCell Identification 0 (UARTPCellID0), offset 0xFF0.....     | 257        |
| Register 22:  | UART PrimeCell Identification 1 (UARTPCellID1), offset 0xFF4.....     | 258        |
| Register 23:  | UART PrimeCell Identification 2 (UARTPCellID2), offset 0xFF8.....     | 259        |
| Register 24:  | UART PrimeCell Identification 3 (UARTPCellID3), offset 0xFFC .....    | 260        |
| <b>Synchronous Serial Interface (SSI) .....</b>       |   | <b>261</b> |
| Register 1:   | SSI Control 0 (SSICR0), offset 0x000 .....                            | 273        |
| Register 2:   | SSI Control 1 (SSICR1), offset 0x004 .....                            | 275        |
| Register 3:   | SSI Data (SSIDR), offset 0x008 .....                                  | 277        |
| Register 4:   | SSI Status (SSISR), offset 0x00C .....                                | 278        |
| Register 5:   | SSI Clock Prescale (SSICPSR), offset 0x010 .....                      | 279        |
| Register 6:   | SSI Interrupt Mask (SSIIM), offset 0x014 .....                        | 280        |
| Register 7:   | SSI Raw Interrupt Status (SSIRIS), offset 0x018 .....                 | 281        |
| Register 8:   | SSI Masked Interrupt Status (SSIMIS), offset 0x01C.....               | 282        |
| Register 9:   | SSI Interrupt Clear (SSIICR), offset 0x020.....                       | 283        |
| Register 10:  | SSI Peripheral Identification 4 (SSIPeriphID4), offset 0xFD0.....     | 284        |
| Register 11:  | SSI Peripheral Identification 5 (SSIPeriphID5), offset 0xFD4.....     | 285        |
| Register 12:  | SSI Peripheral Identification 6 (SSIPeriphID6), offset 0xFD8.....     | 286        |
| Register 13:  | SSI Peripheral Identification 7 (SSIPeriphID7), offset 0xFDC .....    | 287        |
| Register 14:  | SSI Peripheral Identification 0 (SSIPeriphID0), offset 0xFE0.....     | 288        |
| Register 15:  | SSI Peripheral Identification 1 (SSIPeriphID1), offset 0xFE4.....     | 289        |
| Register 16:  | SSI Peripheral Identification 2 (SSIPeriphID2), offset 0xFE8.....     | 290        |
| Register 17:  | SSI Peripheral Identification 3 (SSIPeriphID3), offset 0xFEC .....    | 291        |
| Register 18:  | SSI PrimeCell Identification 0 (SSIPCellID0), offset 0xFF0.....       | 292        |
| Register 19:  | SSI PrimeCell Identification 1 (SSIPCellID1), offset 0xFF4.....       | 293        |
| Register 20:  | SSI PrimeCell Identification 2 (SSIPCellID2), offset 0xFF8.....       | 294        |
| Register 21:  | SSI PrimeCell Identification 3 (SSIPCellID3), offset 0xFFC .....      | 295        |
| <b>Inter-Integrated Circuit (I2C) Interface .....</b> |   | <b>296</b> |
| Register 1:   | I2C Master Slave Address (I2CMSA), offset 0x000 .....                 | 307        |
| Register 2:   | I2C Master Control/Status (I2CMCS), offset 0x004.....                 | 308        |

## List of Registers

---

|              |   |     |
|--------------|---|-----|
| Register 3:  | I <sup>2</sup> C Master Data (I2CMDR), offset 0x008.....                      | 313 |
| Register 4:  | I <sup>2</sup> C Master Timer Period (I2CMTPR), offset 0x00C .....            | 314 |
| Register 5:  | I <sup>2</sup> C Master Interrupt Mask (I2CMIMR), offset 0x010 .....          | 315 |
| Register 6:  | I <sup>2</sup> C Master Raw Interrupt Status (I2CMRIS), offset 0x014 .....    | 316 |
| Register 7:  | I <sup>2</sup> C Master Masked Interrupt Status (I2CMMIS), offset 0x018 ..... | 317 |
| Register 8:  | I <sup>2</sup> C Master Interrupt Clear (I2CMICR), offset 0x01C .....         | 318 |
| Register 9:  | I <sup>2</sup> C Master Configuration (I2CMCR), offset 0x020 .....            | 319 |
| Register 10: | I <sup>2</sup> C Slave Own Address (I2CSOAR), offset 0x000 .....              | 320 |
| Register 11: | I <sup>2</sup> C Slave Control/Status (I2CSCSR), offset 0x004 .....           | 321 |
| Register 12: | I <sup>2</sup> C Slave Data (I2CSDR), offset 0x008.....                       | 323 |
| Register 13: | I <sup>2</sup> C Slave Interrupt Mask (I2CSIMR), offset 0x00C .....           | 324 |
| Register 14: | I <sup>2</sup> C Slave Raw Interrupt Status (I2CSRIS), offset 0x010.....      | 325 |
| Register 15: | I <sup>2</sup> C Slave Masked Interrupt Status (I2CSMIS), offset 0x014.....   | 326 |
| Register 16: | I <sup>2</sup> C Slave Interrupt Clear (I2CSICR), offset 0x018 .....          | 327 |

## Revision History

This table provides a summary of the document revisions.

| Date         | Revision | Description   |
|--------------|----------|---|
| July 2006    | 00       | Initial public release of LM3S328, LM3S601, LM3S610, LM3S611, LM3S612, LM3S613, LM3S615, LM3S628, LM3S801, LM3S811, LM3S812, LM3S815, and LM3S828 data sheets.  |
| October 2006 | 01       | <p>Second release of LM3S328, LM3S601, LM3S610, LM3S611, LM3S613, LM3S615, LM3S628, LM3S801, LM3S812, LM3S815, and LM3S828 data sheets. Includes the following changes:</p> <ul style="list-style-type: none"> <li>• Added information on hardware averaging to the ADC chapter.</li> <li>• Updated the clocking examples in the I2C chapter.</li> <li>• Added Serial Flash Loader usage information.</li> <li>• Added “5-V-tolerant” description for GPIOs to feature list, GPIO chapter, and Electrical chapter.</li> <li>• Added maximum values for 20 MHz and 25 MHz parts to Table 9-1, “16-Bit Timer With Prescaler Configurations” in the Timers chapter.</li> <li>• Made the following changes in the System Control chapter: <ul style="list-style-type: none"> <li>- Updated field descriptions in the <b>Run-Mode Clock Configuration (RCC)</b> register .</li> <li>- Updated the internal oscillator clock speed.</li> <li>- Added the <b>Deep-Sleep Clock Configuration (DSLPCFG)</b> register.</li> <li>- Added bus fault information to the clock gating registers.</li> </ul> </li> </ul> |

## About This Document

This data sheet provides reference information for the LM3S628 microcontroller, describing the functional blocks of the system-on-chip (SoC) device designed around the ARM® Cortex™-M3 core.

## Audience

This manual is intended for system software developers, hardware designers, and application developers.

## About This Manual

This document is organized into sections that correspond to each major feature.

## Related Documents

The following documents are referenced by the data sheet, and available on the documentation CD or from the Luminary Micro web site at [www.luminarymicro.com](http://www.luminarymicro.com):

- *ARM® Cortex™-M3 Technical Reference Manual*
- *CoreSight™ Design Kit Technical Reference Manual*
- *ARM® v7-M Architecture Application Level Reference Manual*

The following related documents are also referenced:

- *IEEE Standard 1149.1-Test Access Port and Boundary-Scan Architecture*

This documentation list was current as of publication date. Please check the Luminary Micro web site for additional documentation, including application notes and white papers.

## Documentation Conventions

This document uses the conventions shown in Table 0-1.

**Table 0-1. Documentation Conventions**

| Notation                         | Meaning   |
|----------------------------------|---|
| <b>General Register Notation</b> |   |
| <b>REGISTER</b>                  | APB registers are indicated in uppercase bold. For example, <b>PBORCTL</b> is the Power-On and Brown-Out Reset Control register. If a register name contains a lowercase n, it represents more than one register. For example, <b>SRCRn</b> represents any (or all) of the three Software Reset Control registers: <b>SRCR0</b> , <b>SRCR1</b> , and <b>SRCR2</b> . |
| bit                              | A single bit in a register.   |
| bit field                        | Two or more consecutive and related bits.   |
| offset 0xnnn                     | A hexadecimal increment to a register's address, relative to that module's base address as specified in Table 3-1, "Memory Map," on page 33.  |



Table 0-1. Documentation Conventions

| Notation                              | Meaning   |
|---------------------------------------|---|
| Register <i>N</i>                     | Registers are numbered consecutively throughout the document to aid in referencing them. The register number has no meaning to software.  |
| reserved                              | Register bits marked reserved are reserved for future use. Reserved bits return an indeterminate value, and should never be changed. Only write a reserved bit with its current value.  |
| yy:xx                                 | The range of register bits inclusive from xx to yy. For example, 31:15 means bits 15 through 31 in that register.   |
| <b>Register Bit/Field Types</b>       | This value in the register bit diagram indicates whether software running on the controller can change the value of the bit field.  |
| RO                                    | Software can read this field. Always write the chip reset value.  |
| R/W                                   | Software can read or write this field.  |
| R/W1C                                 | Software can read or write this field. A write of a 0 to a W1C bit does not affect the bit value in the register. A write of a 1 clears the value of the bit in the register; the remaining bits remain unchanged.<br><br>This register type is primarily used for clearing interrupt status bits where the read operation provides the interrupt status and the write of the read value clears only the interrupts being reported at the time the register was read. |
| W1C                                   | Software can write this field. A write of a 0 to a W1C bit does not affect the bit value in the register. A write of a 1 clears the value of the bit in the register; the remaining bits remain unchanged. A read of the register returns no meaningful data.<br><br>This register is typically used to clear the corresponding bit in an interrupt register.   |
| WO                                    | Only a write by software is valid; a read of the register returns no meaningful data.   |
| <b>Register Bit/Field Reset Value</b> | This value in the register bit diagram shows the bit/field value after any reset, unless noted.   |
| 0                                     | Bit cleared to 0 on chip reset.   |
| 1                                     | Bit set to 1 on chip reset.   |
| –                                     | Nondeterministic.   |
| <b>Pin/Signal Notation</b>            |   |
| [ ]                                   | Pin alternate function; a pin defaults to the signal without the brackets.  |
| pin                                   | Refers to the physical connection on the package.   |
| signal                                | Refers to the electrical signal encoding of a pin.  |

**Table 0-1. Documentation Conventions**

| Notation                   | Meaning   |
|----------------------------|---|
| assert a signal            | Change the value of the signal from the logically False state to the logically True state. For active High signals, the asserted signal value is 1 (High); for active Low signals, the asserted signal value is 0 (Low). The active polarity (High or Low) is defined by the signal name (see SIGNAL and $\overline{\text{SIGNAL}}$ below). |
| deassert a signal          | Change the value of the signal from the logically True state to the logically False state.  |
| $\overline{\text{SIGNAL}}$ | Signal names are in uppercase and in the Courier font. An overbar on a signal name indicates that it is active Low. To assert $\overline{\text{SIGNAL}}$ is to drive it Low; to deassert $\overline{\text{SIGNAL}}$ is to drive it High.  |
| SIGNAL                     | Signal names are in uppercase and in the Courier font. An active High signal has no overbar. To assert SIGNAL is to drive it High; to deassert SIGNAL is to drive it Low.   |
| <b>Numbers</b>             |   |
| X                          | An uppercase X indicates any of several values is allowed, where X can be any legal pattern. For example, a binary value of 0X00 can be either 0100 or 0000, a hex value of 0xX is 0x0 or 0x1, and so on.   |
| 0x                         | Hexadecimal numbers have a prefix of 0x. For example, 0x00FF is the hexadecimal number FF. Binary numbers are indicated with a b suffix, for example, 1011b. Decimal numbers are written without a prefix or suffix.  |

# 1 Architectural Overview

The Luminary Micro Stellaris™ family of microcontrollers—the first ARM® Cortex™-M3 based controllers—brings high-performance 32-bit computing to cost-sensitive embedded microcontroller applications. These pioneering parts deliver customers 32-bit performance at a cost equivalent to legacy 8- and 16-bit devices, all in a package with a small footprint.

The LM3S628 controller in the Stellaris family offers the advantages of ARM's widely available development tools, System-on-Chip (SoC) infrastructure IP applications, and a large user community. Additionally, the controller uses ARM's Thumb®-compatible Thumb-2 instruction set to reduce memory requirements and, thereby, cost.

Luminary Micro offers a complete solution to get to market quickly, with a customer development board, white papers and application notes, and a strong support, sales, and distributor network.

## 1.1 Product Features

The LM3S628 microcontroller includes the following product features:

- 32-Bit RISC Performance
  - 32-bit ARM® Cortex™-M3 v7M architecture optimized for small-footprint embedded applications
  - Thumb®-compatible Thumb-2-only instruction set processor core for high code density
  - 50-MHz operation
  - Hardware-division and single-cycle-multiplication
  - Integrated Nested Vectored Interrupt Controller (NVIC) providing deterministic interrupt handling
  - 22 interrupts with eight priority levels
  - Memory protection unit (MPU) provides a privileged mode for protected operating system functionality
  - Unaligned data access, enabling data to be efficiently packed into memory
  - Atomic bit manipulation (bit-banding) delivers maximum memory utilization and streamlined peripheral control
- Internal Memory
  - 32 KB single-cycle flash
    - User-managed flash block protection on a 2-KB block basis
    - User-managed flash data programming
    - User-defined and managed flash-protection block
  - 8 KB single-cycle SRAM
- General-Purpose Timers
  - Three timers, each of which can be configured: as a single 32-bit timer , as two 16-bit timers, or to initiate an ADC event
  - 32-bit Timer modes:
    - Programmable one-shot timer
    - Programmable periodic timer
    - Real-Time Clock when using an external 32.768-KHz clock as the input

- User-enabled stalling in periodic and one-shot mode when the controller asserts the CPU Halt flag during debug
- ADC event trigger
- 16-bit Timer modes:
  - General-purpose timer function with an 8-bit prescaler
  - Programmable one-shot timer
  - Programmable periodic timer
  - User-enabled stalling when the controller asserts CPU Halt flag during debug
  - ADC event trigger
- 16-bit Input Capture modes:
  - Input edge count capture
  - Input edge time capture
- 16-bit PWM mode:
  - Simple PWM mode with software-programmable output inversion of the PWM signal
- ARM FIRMM-compliant Watchdog Timer
  - 32-bit down counter with a programmable load register
  - Separate watchdog clock with an enable
  - Programmable interrupt generation logic with interrupt masking
  - Lock register protection from runaway software
  - Reset generation logic with an enable/disable
  - User-enabled stalling when the controller asserts the CPU Halt flag during debug
- Synchronous Serial Interface (SSI)
  - Master or slave operation
  - Programmable clock bit rate and prescale
  - Separate transmit and receive FIFOs, 16 bits wide, 8 locations deep
  - Programmable interface operation for Freescale SPI, MICROWIRE, or Texas Instruments synchronous serial interfaces
  - Programmable data frame size from 4 to 16 bits
  - Internal loopback test mode for diagnostic/debug testing
- UART
  - Two fully programmable 16C550-type UARTs
  - Separate 16x8 transmit (TX) and 16x12 receive (RX) FIFOs to reduce CPU interrupt service loading
  - Programmable baud-rate generator with fractional divider
  - Programmable FIFO length, including 1-byte deep operation providing conventional double-buffered interface
  - FIFO trigger levels of 1/8, 1/4, 1/2, 3/4, and 7/8
  - Standard asynchronous communication bits for start, stop, and parity

- False-start-bit detection
- Line-break generation and detection
- ADC
  - Single- and differential-input configurations
  - Eight 10-bit channels (inputs) when used as single-ended inputs
  - Sample rate of one million samples/second
  - Flexible, configurable analog-to-digital conversion
  - Four programmable sample conversion sequences from one to eight entries long, with corresponding conversion result FIFOs
  - Each sequence triggered by software or internal event (timers or GPIO)
- I<sup>2</sup>C
  - Master and slave receive and transmit operation with transmission speed up to 100 Kbps in Standard mode and 400 Kbps in Fast mode
  - Interrupt generation
  - Master with arbitration and clock synchronization, multimaster support, and 7-bit addressing mode
- GPIOs
  - 9 to 28 GPIOs, depending on configuration
  - 5-V-tolerant input/outputs
  - Programmable interrupt generation as either edge-triggered or level-sensitive
  - Bit masking in both read and write operations through address lines
  - Can initiate an ADC sample sequence
  - Programmable control for GPIO pad configuration:
    - Weak pull-up or pull-down resistors
    - 2-mA, 4-mA, and 8-mA pad drive
    - Slew rate control for the 8-mA drive
    - Open drain enables
    - Digital input enables
- Power
  - On-chip Low Drop-Out (LDO) voltage regulator, with programmable output user-adjustable from 2.25 V to 2.75 V
  - Low-power options on controller: Sleep and Deep-sleep modes
  - Low-power options for peripherals: software controls shutdown of individual peripherals
  - User-enabled LDO unregulated voltage detection and automatic reset
  - 3.3-V supply brownout detection and reporting via interrupt or reset
  - On-chip temperature sensor
- Flexible Reset Sources
  - Power-on reset (POR)

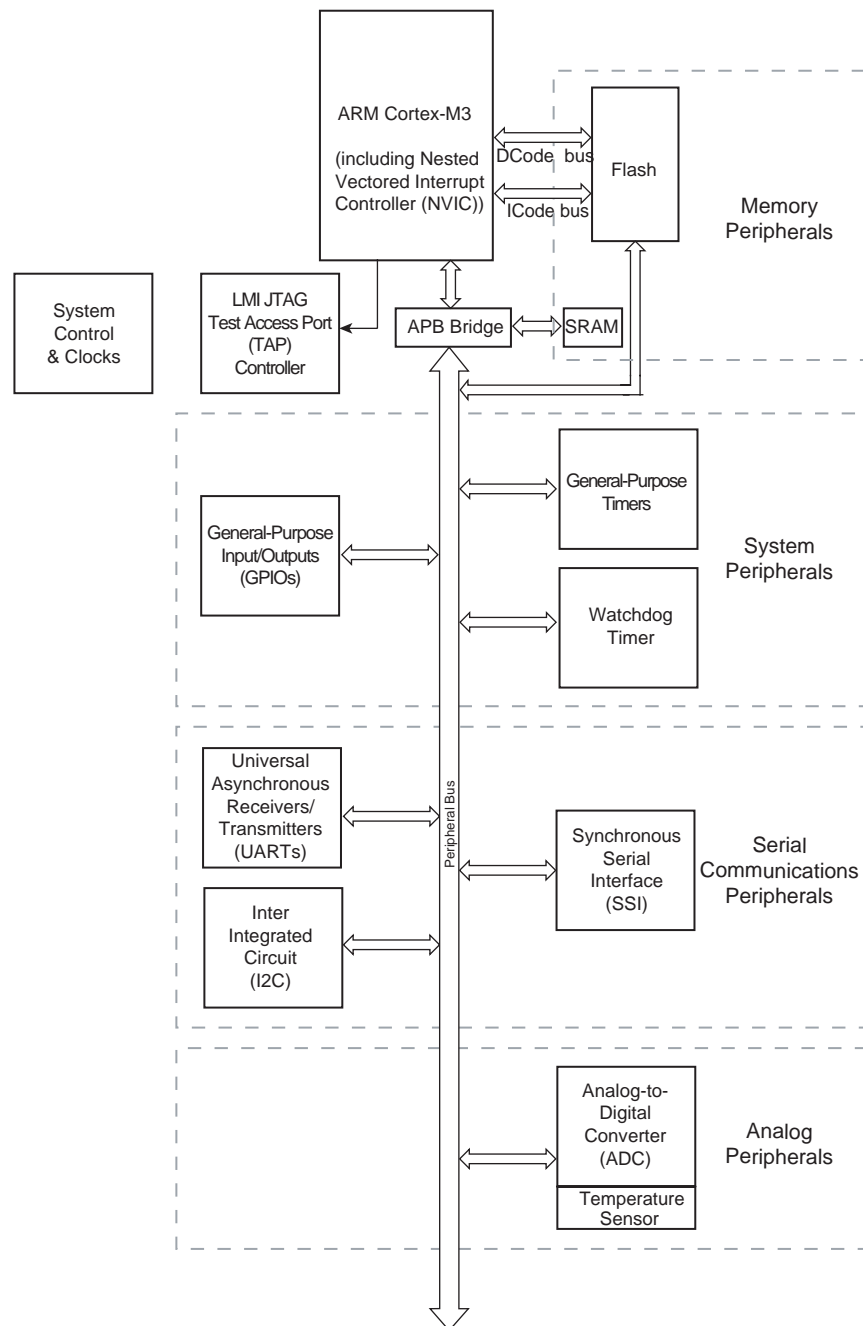
- Reset pin assertion
- Brown-out (BOR) detector alerts to system power drops
- Software reset
- Watchdog timer reset
- Internal low drop-out (LDO) regulator output goes unregulated
- Additional Features
  - Six reset sources
  - Programmable clock source control
  - Clock gating to individual peripherals for power savings
  - IEEE 1149.1-1990 compliant Test Access Port (TAP) controller
  - Debug access via JTAG and Serial Wire interfaces
  - Full JTAG boundary scan
- Industrial-range 48-pin RoHS-compliant LQFP package

## **1.2 Target Applications**

- Factory automation and control
- Industrial control power devices
- Building and home automation

## 1.3 High-Level Block Diagram

Figure 1-1. Stellaris High-Level Block Diagram



LM3S628

## 1.4 Functional Overview

The following sections provide an overview of the features of the LM3S628 microcontroller. The chapter number in parenthesis indicates where that feature is discussed in detail. Ordering and support information can be found in “Ordering and Contact Information” on page 356.

### 1.4.1 ARM Cortex™-M3

#### 1.4.1.1 Processor Core (Section 2 on page 30)

All members of the Stellaris product family, including the LM3S628 microcontroller, are designed around an ARM Cortex™-M3 processor core. The ARM Cortex-M3 processor provides the core for a high-performance, low-cost platform that meets the needs of minimal memory implementation, reduced pin count, and low power consumption, while delivering outstanding computational performance and exceptional system response to interrupts.

Section 2, “ARM Cortex-M3 Processor Core,” on page 30 provides an overview of the ARM core; the core is detailed in the *ARM® Cortex™-M3 Technical Reference Manual*.

#### 1.4.1.2 Nested Vectored Interrupt Controller (NVIC)

The LM3S628 controller includes the ARM Nested Vectored Interrupt Controller (NVIC) on the ARM Cortex-M3 core. The NVIC and Cortex-M3 prioritize and handle all exceptions. All exceptions are handled in Handler Mode. The processor state is automatically stored to the stack on an exception, and automatically restored from the stack at the end of the Interrupt Service Routine (ISR). The vector is fetched in parallel to the state saving, which enables efficient interrupt entry. The processor supports tail-chaining, which enables back-to-back interrupts to be performed without the overhead of state saving and restoration. Software can set eight priority levels on 7 exceptions (system handlers) and 22 interrupts.

Section 4, “Interrupts,” on page 35 provides an overview of the NVIC controller and the interrupt map. Exceptions and interrupts are detailed in the *ARM® Cortex™-M3 Technical Reference Manual*.

### 1.4.2 Motor Control Peripherals

To enhance motor control, the LM3S628 controller features Pulse Width Modulation (PWM) outputs.

#### 1.4.2.1 PWM (“16-Bit PWM Mode” on page 149)

Pulse width modulation (PWM) is a powerful technique for digitally encoding analog signal levels. High-resolution counters are used to generate a square wave, and the duty cycle of the square wave is modulated to encode an analog signal. Typical applications include switching power supplies and motor control.

On the LM3S628, PWM motion control functionality can be achieved through the motion control features of the general-purpose timers (using the CCP pins).

The General-Purpose Timer Module’s CCP (Capture Compare PWM) pins are software programmable to support a simple PWM mode with a software-programmable output inversion of the PWM signal.

### 1.4.3 Analog Peripherals

To handle analog signals, the LM3S628 controller offers an Analog-to-Digital Converter (ADC).

#### 1.4.3.1 ADC (Section 11 on page 195)

An analog-to-digital converter (ADC) is a peripheral that converts a continuous analog voltage to a discrete digital number.



The Stellaris ADC module features 10-bit conversion resolution and supports eight input channels, plus an internal temperature sensor. Four buffered sample sequences allow rapid sampling of up to eight analog input sources without controller intervention. Each sample sequence provides flexible programming with fully configurable input source, trigger events, interrupt generation, and sequence priority.

The comparator can provide its output to a device pin or triggers to the ADC and ADC triggering. This means, for example, that an interrupt can be generated on a rising edge and the ADC triggered on a falling edge.

#### 1.4.4 Serial Communications Peripherals

The LM3S628 controller supports both asynchronous and synchronous serial communications with two fully programmable 16C550-type UARTs, SSI and I<sup>2</sup>C serial communications.

##### 1.4.4.1 UART (Section 12 on page 225)

A Universal Asynchronous Receiver/Transmitter (UART) is an integrated circuit used for RS-232C serial communications, containing a transmitter (parallel-to-serial converter) and a receiver (serial-to-parallel converter), each clocked separately.

The LM3S628 controller includes two fully programmable 16C550-type UARTs that support data transfer speeds up to 460.8 Kbps. (Although similar in functionality to a 16C550 UART, it is not register compatible.)

Separate 16x8 transmit (TX) and 16x12 receive (RX) FIFOs reduce CPU interrupt service loading. The UART can generate individually masked interrupts from the RX, TX, modem status, and error conditions. The module provides a single combined interrupt when any of the interrupts are asserted and are unmasked.

##### 1.4.4.2 SSI (Section 13 on page 261)

Synchronous Serial Interface (SSI) is a four-wire bi-directional communications interface.

The Stellaris SSI module provides the functionality for synchronous serial communications with peripheral devices, and can be configured to use the Freescale SPI, MICROWIRE, or TI synchronous serial interface frame formats. The size of the data frame is also configurable, and can be set between 4 and 16 bits, inclusive.

The SSI module performs serial-to-parallel conversion on data received from a peripheral device, and parallel-to-serial conversion on data transmitted to a peripheral device. The TX and RX paths are buffered with internal FIFOs, allowing up to eight 16-bit values to be stored independently.

The SSI module can be configured as either a master or slave device. As a slave device, the SSI module can also be configured to disable its output, which allows a master device to be coupled with multiple slave devices.

The SSI module also includes a programmable bit rate clock divider and prescaler to generate the output serial clock derived from the SSI module's input clock. Bit rates are generated based on the input clock and the maximum bit rate is determined by the connected peripheral.

##### 1.4.4.3 I<sup>2</sup>C (Section 14 on page 296)

The Inter-Integrated Circuit (I<sup>2</sup>C) bus provides bi-directional data transfer through a two-wire design (a serial data line SDA and a serial clock line SCL).

The I<sup>2</sup>C bus interfaces to external I<sup>2</sup>C devices such as serial memory (RAMs and ROMs), networking devices, LCDs, tone generators, and so on. The I<sup>2</sup>C bus may also be used for system testing and diagnostic purposes in product development and manufacture.

The Stellaris I<sup>2</sup>C module provides the ability to communicate to other IC devices over an I<sup>2</sup>C bus. The I<sup>2</sup>C bus supports devices that can both transmit and receive (write and read) data.

Devices on the I<sup>2</sup>C bus can be designated as either a master or a slave. The I<sup>2</sup>C module supports both sending and receiving data as either a master or a slave, and also supports the simultaneous operation as both a master and a slave. The four I<sup>2</sup>C modes are: Master Transmit, Master Receive, Slave Transmit, and Slave Receive.

The Stellaris I<sup>2</sup>C module can operate at two speeds: Standard (100 Kbps) and Fast (400 Kbps).

Both the I<sup>2</sup>C master and slave can generate interrupts. The I<sup>2</sup>C master generates interrupts when a transmit or receive operation completes (or aborts due to an error). The I<sup>2</sup>C slave generates interrupts when data has been sent or requested by a master.

## 1.4.5 System Peripherals

### 1.4.5.1 Programmable GPIOs (Section 8 on page 102)

General-purpose input/output (GPIO) pins offer flexibility for a variety of connections.

The Stellaris GPIO module is composed of five physical GPIO blocks, each corresponding to an individual GPIO port. The GPIO module is FIRM-compliant (compliant to the ARM Foundation IP for Real-Time Microcontrollers specification) and supports 9 to 28 programmable input/output pins. The number of GPIOs available depends on the peripherals being used (see Table 16-4 on page 335 for the signals available to each GPIO pin).

The GPIO module features programmable interrupt generation as either edge-triggered or level-sensitive on all pins, programmable control for GPIO pad configuration, and bit masking in both read and write operations through address lines.

### 1.4.5.2 Three Programmable Timers (Section 9 on page 140)

Programmable timers can be used to count or time external events that drive the Timer input pins.

The Stellaris General-Purpose Timer Module (GPTM) contains three GPTM blocks. Each GPTM block provides two 16-bit timer/counters that can be configured to operate independently as timers or event counters, or configured to operate as one 32-bit timer or one 32-bit Real-Time Clock (RTC). Timers can also be used to trigger analog-to-digital (ADC) conversions.

When configured in 32-bit mode, a timer can run as a one-shot timer, periodic timer, or Real-Time Clock (RTC). When in 16-bit mode, a timer can run as a one-shot timer or periodic timer, and can extend its precision by using an 8-bit prescaler. A 16-bit timer can also be configured for event capture or Pulse Width Modulation (PWM) generation.

### 1.4.5.3 Watchdog Timer (Section 10 on page 172)

A watchdog timer can generate nonmaskable interrupts (NMIs) or a reset when a time-out value is reached. The watchdog timer is used to regain control when a system has failed due to a software error or to the failure of an external device to respond in the expected way.

The Stellaris Watchdog Timer module consists of a 32-bit down counter, a programmable load register, interrupt generation logic, and a locking register.

The Watchdog Timer can be configured to generate an interrupt to the controller on its first time-out, and to generate a reset signal on its second time-out. Once the Watchdog Timer has been configured, the lock register can be written to prevent the timer configuration from being inadvertently altered.

## 1.4.6 Memory Peripherals

The Stellaris controllers offer both SRAM and Flash memory.

#### 1.4.6.1 SRAM (Section 7.2.1 on page 88)

The LM3S628 static random access memory (SRAM) controller supports 8 KB SRAM. The internal SRAM of the Stellaris devices is located at address 0x20000000 of the device memory map. To reduce the number of time consuming read-modify-write (RMW) operations, ARM has introduced *bit-banding* technology in the new Cortex-M3 processor. With a bit-band-enabled processor, certain regions in the memory map (SRAM and peripheral space) can use address aliases to access individual bits in a single, atomic operation.

#### 1.4.6.2 Flash (Section 7.2.2 on page 89)

The LM3S628 Flash controller supports 32 KB of flash memory. The flash is organized as a set of 1-KB blocks that can be individually erased. Erasing a block causes the entire contents of the block to be reset to all 1s. These blocks are paired into a set of 2-KB blocks that can be individually protected. The blocks can be marked as read-only or execute-only, providing different levels of code protection. Read-only blocks cannot be erased or programmed, protecting the contents of those blocks from being modified. Execute-only blocks cannot be erased or programmed, and can only be read by the controller instruction fetch mechanism, protecting the contents of those blocks from being read by either the controller or by a debugger.

### 1.4.7 Additional Features

#### 1.4.7.1 Memory Map (Section 3 on page 33)

A memory map lists the location of instructions and data in memory. The memory map for the LM3S628 controller can be found on page 33. Register addresses are given as a hexadecimal increment, relative to the module's base address as shown in the memory map.

The *ARM® Cortex™-M3 Technical Reference Manual* provides further information on the memory map.

#### 1.4.7.2 JTAG TAP Controller (Section 5 on page 38)

The Joint Test Action Group (JTAG) port provides a standardized serial interface for controlling the Test Access Port (TAP) and associated test logic. The TAP, JTAG instruction register, and JTAG data registers can be used to test the interconnects of assembled printed circuit boards, obtain manufacturing information on the components, and observe and/or control the inputs and outputs of the controller during normal operation. The JTAG port provides a high degree of testability and chip-level access at a low cost.

The JTAG port is comprised of the standard five pins:  $\overline{\text{TRST}}$ , TCK, TMS, TDI, and TDO. Data is transmitted serially into the controller on TDI and out of the controller on TDO. The interpretation of this data is dependent on the current state of the TAP controller. For detailed information on the operation of the JTAG port and TAP controller, please refer to the *IEEE Standard 1149.1-Test Access Port and Boundary-Scan Architecture*.

The LMI JTAG controller works with the ARM JTAG controller built into the Cortex-M3 core. This is implemented by multiplexing the TDO outputs from both JTAG controllers. ARM JTAG instructions select the ARM TDO output while LMI JTAG instructions select the LMI TDO outputs. The multiplexer is controlled by the LMI JTAG controller, which has comprehensive programming for the ARM, LMI, and unimplemented JTAG instructions.

#### 1.4.7.3 System Control and Clocks (Section 6 on page 48)

System control determines the overall operation of the device. It provides information about the device, controls the clocking of the device and individual peripherals, and handles reset detection and reporting.

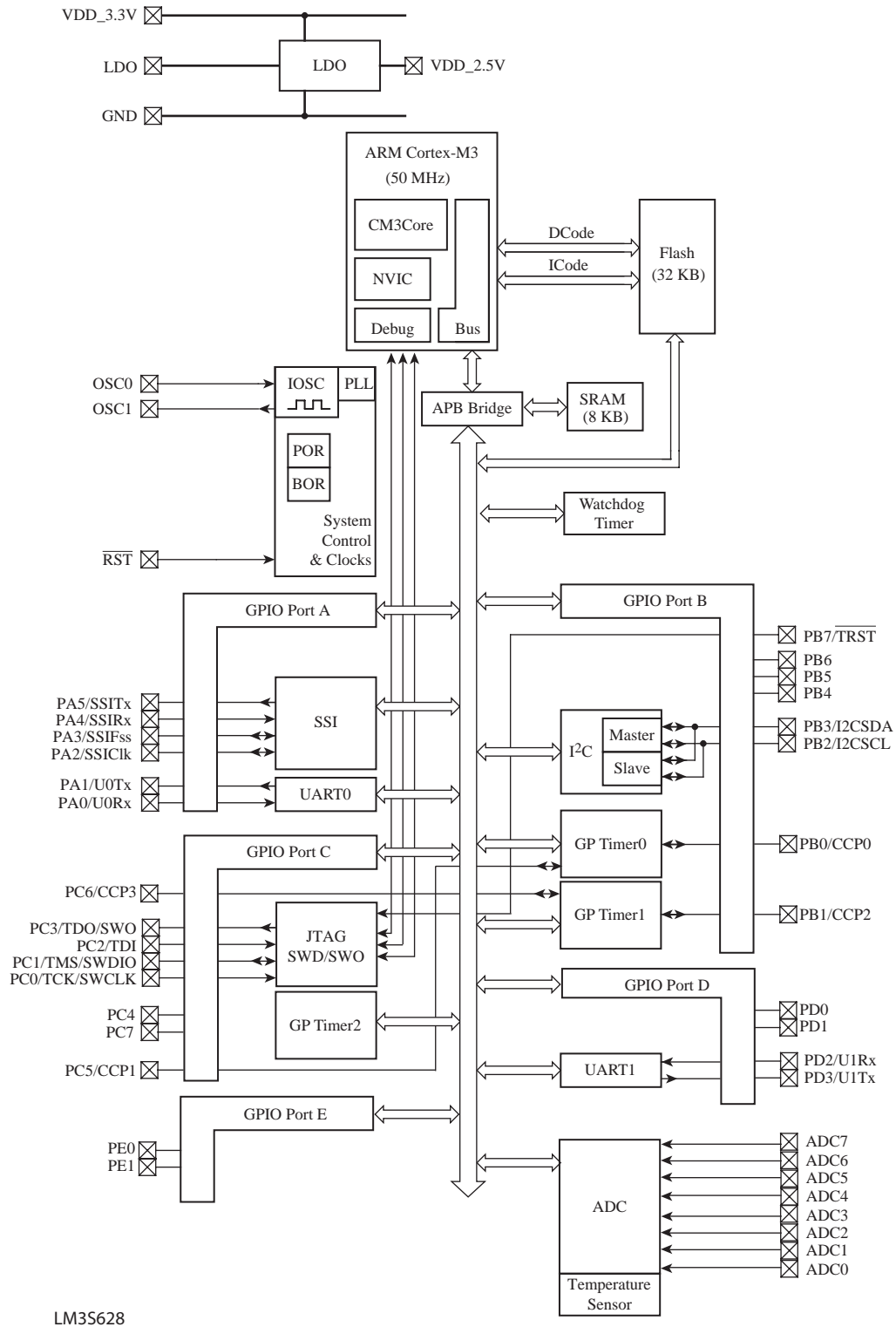
## **1.4.8 Hardware Details**

Details on the pins and package can be found in the following sections:

- Section 15, "Pin Diagram," on page 328
- Section 16, "Signal Tables," on page 329
- Section 17, "Operating Characteristics," on page 337
- Section 18, "Electrical Characteristics," on page 338
- Section 19, "Package Information," on page 351

# 1.5 System Block Diagram

Figure 1-2. LM3S628 Controller System-Level Block Diagram



LM3S628

## 2 ARM Cortex-M3 Processor Core

The ARM Cortex-M3 processor provides the core for a high-performance, low-cost platform that meets the needs of minimal memory implementation, reduced pin count, and low power consumption, while delivering outstanding computational performance and exceptional system response to interrupts. Features include:

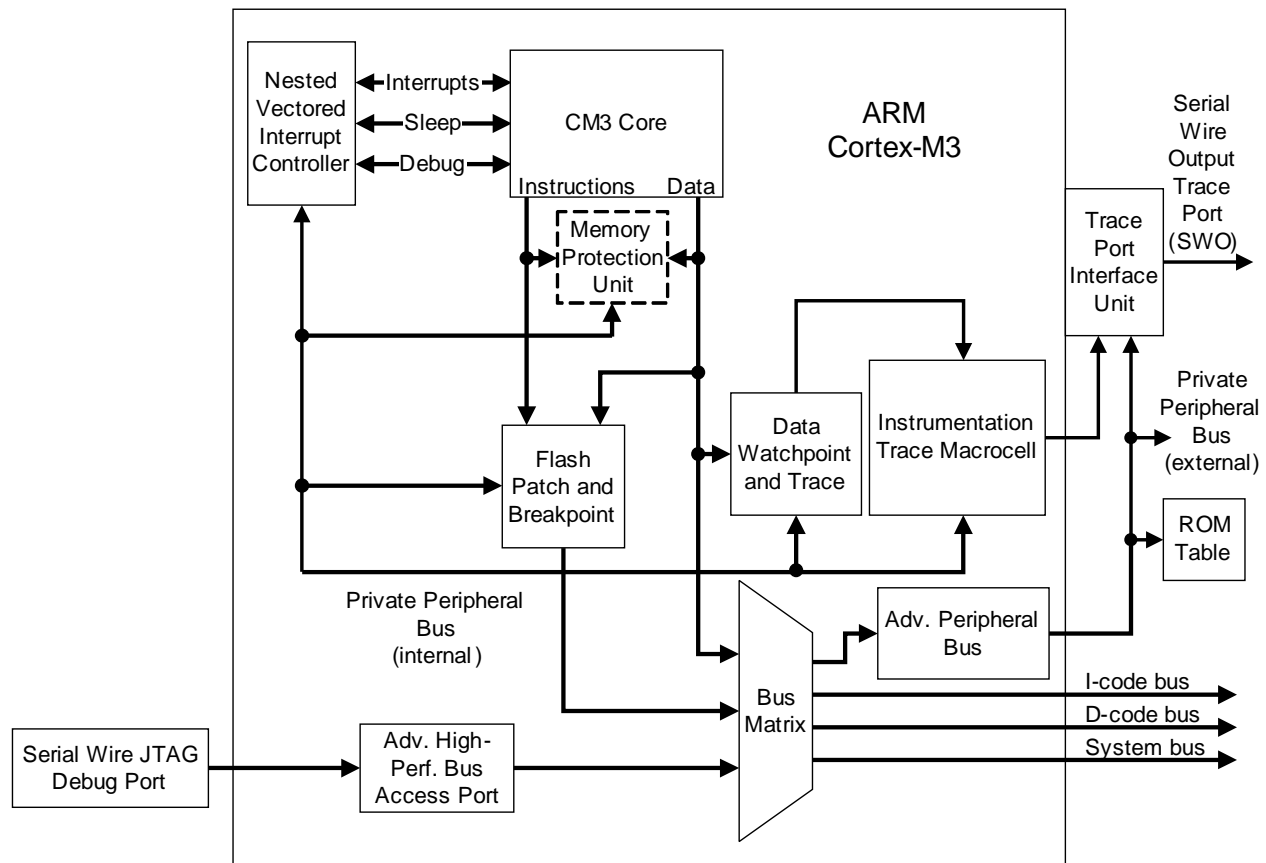
- Compact core.
- Thumb-2 instruction set, delivering the high-performance expected of an ARM core in the memory size usually associated with 8- and 16-bit devices; typically in the range of a few kilobytes of memory for microcontroller class applications.
- Exceptional interrupt handling, by implementing the register manipulations required for handling an interrupt in hardware.
- Memory protection unit (MPU) to provide a privileged mode of operation for complex applications.
- Full-featured debug solution with a:
  - Serial Wire JTAG Debug Port (SWJ-DP)
  - Flash Patch and Breakpoint (FPB) unit for implementing breakpoints
  - Data Watchpoint and Trigger (DWT) unit for implementing watchpoints, trigger resources, and system profiling
  - Instrumentation Trace Macrocell (ITM) for support of printf style debugging
  - Trace Port Interface Unit (TPIU) for bridging to a Trace Port Analyzer

The Stellaris family of microcontrollers builds on this core to bring high-performance 32-bit computing to cost-sensitive embedded microcontroller applications, such as factory automation and control, industrial control power devices, and building and home automation.

For more information on the ARM Cortex-M3 processor core, see the *ARM® Cortex™-M3 Technical Reference Manual*. For information on SWJ-DP, see the *CoreSight™ Design Kit Technical Reference Manual*.

## 2.1 Block Diagram

Figure 2-1. CPU Block Diagram



## 2.2 Functional Description

**Important:** The *ARM® Cortex™-M3 Technical Reference Manual* describes all the features of an ARM Cortex-M3 in detail. However, these features differ based on the implementation. This section describes the Stellaris implementation.

Luminary Micro has implemented the ARM Cortex-M3 core as shown in Figure 2-1. As noted in the *ARM® Cortex™-M3 Technical Reference Manual*, several Cortex-M3 components are flexible in their implementation: SW/JTAG-DP, ETM, TPIU, the ROM table, the MPU, and the Nested Vectored Interrupt Controller (NVIC). Each of these is addressed in the sections that follow.

### 2.2.1 Serial Wire and JTAG Debug

Luminary Micro has replaced the ARM SW-DP and JTAG-DP with the ARM CoreSight™-compliant Serial Wire JTAG Debug Port (SWJ-DP) interface. This means Chapter 12, “Debug Port,” of the *ARM® Cortex™-M3 Technical Reference Manual* does not apply to Stellaris devices.

The SWJ-DP interface combines the SWD and JTAG debug ports into one module. See the *CoreSight™ Design Kit Technical Reference Manual* for details on SWJ-DP.

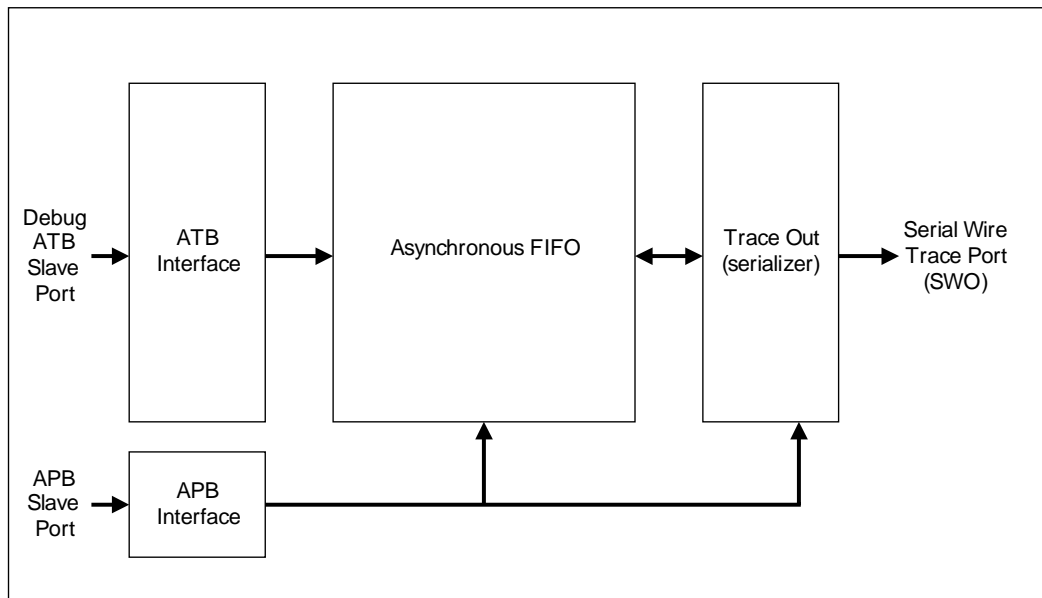
## 2.2.2 Embedded Trace Macrocell (ETM)

ETM was not implemented in the Stellaris devices. This means Chapters 15 and 16 of the *ARM® Cortex™-M3 Technical Reference Manual* can be ignored.

## 2.2.3 Trace Port Interface Unit (TPIU)

The TPIU acts as a bridge between the Cortex-M3 trace data from the ITM, and an off-chip Trace Port Analyzer. The Stellaris devices have implemented TPIU as shown in Figure 2-2. This is similar to the non-ETM version described in the *ARM® Cortex™-M3 Technical Reference Manual*, however, SWJ-DP only provides SWV output for the TPIU.

**Figure 2-2. TPIU Block Diagram**



## 2.2.4 ROM Table

The default ROM table was implemented as described in the *ARM® Cortex™-M3 Technical Reference Manual*.

## 2.2.5 Memory Protection Unit (MPU)

The Memory Protection Unit (MPU) is included on the LM3S628 controller and supports the standard ARMv7 Protected Memory System Architecture (PMSA) model. The MPU provides full support for protection regions, overlapping protection regions, access permissions, and exporting memory attributes to the system.

## 2.2.6 Nested Vectored Interrupt Controller (NVIC)

### 2.2.6.1 Interrupts

The *ARM® Cortex™-M3 Technical Reference Manual* describes the maximum number of interrupts and interrupt priorities. The LM3S628 microcontroller supports 22 interrupts with eight priority levels.

### 2.2.6.2 SysTick Calibration Value Registers

The SysTick Calibration Value register is not implemented.



### 3 Memory Map

The memory map for the LM3S628 is provided in Table 3-1. In this manual, register addresses are given as a hexadecimal increment, relative to the module's base address as shown in the memory map. See also Chapter 4, "Memory Map" in the *ARM® Cortex™-M3 Technical Reference Manual*.

**Table 3-1. Memory Map (Sheet 1 of 2)**

| Start                   | End        | Description   | For details on registers, see ... |
|-------------------------|------------|---|-----------------------------------|
| <b>Memory</b>           |            |   |                                   |
| 0x00000000              | 0x00007FFF | On-chip flash   | page 92                           |
| 0x00008000              | 0x1FFFFFFF | Reserved <sup>a</sup>   |                                   |
| 0x20000000              | 0x20001FFF | Bit-banded on-chip SRAM   | -                                 |
| 0x20002000              | 0x200FFFFF | Reserved <sup>a</sup>   | -                                 |
| 0x22000000              | 0x2203FFFF | Bit-band alias of 0x20000000 through 0x20001FFF                                     | -                                 |
| 0x22040000              | 0x23FFFFFF | Reserved <sup>a</sup>   | -                                 |
| <b>FiRM Peripherals</b> |            |   |                                   |
| 0x40000000              | 0x40000FFF | Watchdog timer  | page 174                          |
| 0x40001000              | 0x40003FFF | Reserved for three additional watchdog timers (per FiRM specification) <sup>a</sup> | -                                 |
| 0x40004000              | 0x40004FFF | GPIO Port A   | page 109                          |
| 0x40005000              | 0x40005FFF | GPIO Port B   | page 109                          |
| 0x40006000              | 0x40006FFF | GPIO Port C   | page 109                          |
| 0x40007000              | 0x40007FFF | GPIO Port D   |                                   |
| 0x40008000              | 0x40008FFF | SSI   | page 272                          |
| 0x40009000              | 0x4000BFFF | Reserved for three additional SSIs (per FiRM specification) <sup>a</sup>            | -                                 |
| 0x4000C000              | 0x4000CFFF | UART0   | page 231                          |
| 0x4000D000              | 0x4000DFFF | UART1   | page 231                          |
| 0x4000E000              | 0x4000FFFF | Reserved for two additional UARTs (per FiRM specification) <sup>a</sup>             | -                                 |
| 0x40010000              | 0x4001FFFF | Reserved for future FiRM peripherals <sup>a</sup>                                   | -                                 |
| <b>Peripherals</b>      |            |   |                                   |
| 0x40020000              | 0x400207FF | I <sup>2</sup> C Master   | page 306                          |
| 0x40020800              | 0x40020FFF | I <sup>2</sup> C Slave  | page 320                          |
| 0x40021000              | 0x40023FFF | Reserved <sup>a</sup>   | -                                 |

Table 3-1. Memory Map (Sheet 2 of 2)

| Start                         | End        | Description                                     | For details on registers, see ...                         |
|-------------------------------|------------|---|---|
| 0x40024000                    | 0x40024FFF | GPIO Port E                                     | page 109  |
| 0x40025000                    | 0x40025FFF | Reserved <sup>a</sup>                           | -   |
| 0x40028000                    | 0x4002BFFF | Reserved <sup>a</sup>                           | -   |
| 0x4002C000                    | 0x4002FFFF | Reserved <sup>a</sup>                           | -   |
| 0x40030000                    | 0x40030FFF | Timer0  | page 151  |
| 0x40031000                    | 0x40031FFF | Timer1  | page 151  |
| 0x40032000                    | 0x40032FFF | Timer2  | page 151  |
| 0x40033000                    | 0x40037FFF | Reserved <sup>a</sup>                           | -   |
| 0x40038000                    | 0x40038FFF | ADC   | page 200  |
| 0x40039000                    | 0x4003BFFF | Reserved <sup>a</sup>                           | -   |
| 0x4003C000                    | 0x4003CFFF | Reserved <sup>a</sup>                           | -   |
| 0x4003D000                    | 0x400FCFFF | Reserved <sup>a</sup>                           | -   |
| 0x400FD000                    | 0x400FDFFF | Flash control                                   | page 92   |
| 0x400FE000                    | 0x400FFFFF | System control                                  | page 55   |
| 0x40100000                    | 0x41FFFFFF | Reserved <sup>a</sup>                           | -   |
| 0x42000000                    | 0x43FFFFFF | Bit-band alias of 0x40000000 through 0x400FFFFF | -   |
| 0x44000000                    | 0xDFFFFFFF | Reserved <sup>a</sup>                           | -   |
| <b>Private Peripheral Bus</b> |            |   |   |
| 0xE0000000                    | 0xE0000FFF | Instrumentation Trace Macrocell (ITM)           | <i>ARM® Cortex™-M3<br/>Technical Reference<br/>Manual</i> |
| 0xE0001000                    | 0xE0001FFF | Data Watchpoint and Trace (DWT)                 |   |
| 0xE0002000                    | 0xE0002FFF | Flash Patch and Breakpoint (FPB)                |   |
| 0xE0003000                    | 0xE000DFFF | Reserved <sup>a</sup>                           |   |
| 0xE000E000                    | 0xE000EFFF | Nested Vectored Interrupt Controller (NVIC)     |   |
| 0xE000F000                    | 0xE003FFFF | Reserved <sup>a</sup>                           |   |
| 0xE0040000                    | 0xE0040FFF | Trace Port Interface Unit (TPIU)                |   |
| 0xE0041000                    | 0xE0041FFF | Reserved <sup>a</sup>                           | -   |
| 0xE0042000                    | 0xE00FFFFF | Reserved <sup>a</sup>                           | -   |
| 0xE0100000                    | 0xFFFFFFFF | Reserved for vendor peripherals <sup>a</sup>    | -   |

a. All reserved space returns a bus fault when read or written.

## 4 Interrupts

The ARM Cortex-M3 processor and the Nested Vectored Interrupt Controller (NVIC) prioritize and handle all exceptions. All exceptions are handled in Handler Mode. The processor state is automatically stored to the stack on an exception, and automatically restored from the stack at the end of the Interrupt Service Routine (ISR). The vector is fetched in parallel to the state saving, which enables efficient interrupt entry. The processor supports tail-chaining, which enables back-to-back interrupts to be performed without the overhead of state saving and restoration.

Table 4-1 lists all the exceptions. Software can set eight priority levels on seven of these exceptions (system handlers) as well as on 22 interrupts (listed in Table 4-2). Priorities on the system handlers are set with the NVIC System Handler Priority registers. Interrupts are enabled through the NVIC Interrupt Set Enable register and prioritized with the NVIC Interrupt Priority registers. You can also group priorities by splitting priority levels into pre-emption priorities and subpriorities. All the interrupt registers are described in Chapter 8, “Nested Vectored Interrupt Controller” in the *ARM® Cortex™-M3 Technical Reference Manual*.

Internally, the highest user-settable priority (0) is treated as fourth priority, after a Reset, NMI, and a Hard Fault. Note that 0 is the default priority for all the settable priorities.

If you assign the same priority level to two or more interrupts, their hardware priority (the lower the position number) determines the order in which the processor activates them. For example, if both GPIO Port A and GPIO Port B are priority level 1, then GPIO Port A has higher priority.

See Chapter 5, “Exceptions” and Chapter 8, “Nested Vectored Interrupt Controller” in the *ARM® Cortex™-M3 Technical Reference Manual* for more information on exceptions and interrupts.

**Table 4-1. Exception Types**

| Exception Type               | Position | Priority <sup>a</sup> | Description   |
|------------------------------|----------|-----------------------|---|
| -                            | 0        | -                     | Stack top is loaded from first entry of vector table on reset.  |
| Reset                        | 1        | -3 (highest)          | Invoked on power up and warm reset. On first instruction, drops to lowest priority (and then is called the base level of activation). This is asynchronous.                               |
| Non-Maskable Interrupt (NMI) | 2        | -2                    | Cannot be stopped or preempted by any exception but reset. This is asynchronous.<br>An NMI is only producible by software, using the NVIC <b>Interrupt Control State</b> register.        |
| Hard Fault                   | 3        | -1                    | All classes of Fault, when the fault cannot activate due to priority or the configurable fault handler has been disabled. This is synchronous.  |
| Memory Management            | 4        | settable              | MPU mismatch, including access violation and no match. This is synchronous.<br>The priority of this exception can be changed.   |
| Bus Fault                    | 5        | settable              | Pre-fetch fault, memory access fault, and other address/memory related faults. This is synchronous when precise and asynchronous when imprecise.<br>You can enable or disable this fault. |

**Table 4-1. Exception Types (Continued)**

| Exception Type | Position     | Priority <sup>a</sup> | Description  |
|----------------|--------------|-----------------------|--|
| Usage Fault    | 6            | settable              | Usage fault, such as undefined instruction executed or illegal state transition attempt. This is synchronous.  |
| -              | 7-10         | -                     | Reserved.  |
| SVCcall        | 11           | settable              | System service call with SVC instruction. This is synchronous.   |
| Debug Monitor  | 12           | settable              | Debug monitor (when not halting). This is synchronous, but only active when enabled. It does not activate if lower priority than the current activation.                   |
| -              | 13           | -                     | Reserved.  |
| PendSV         | 14           | settable              | Pendable request for system service. This is asynchronous and only pended by software.   |
| SysTick        | 15           | settable              | System tick timer has fired. This is asynchronous.   |
| Interrupts     | 16 and above | settable              | Asserted from outside the ARM Cortex-M3 core and fed through the NVIC (prioritized). These are all asynchronous. Table 4-2 lists the interrupts on the LM3S628 controller. |

a. 0 is the default priority for all the settable priorities.

**Table 4-2. Interrupts**

| Interrupt (Bit in Interrupt Registers) | Description      |
|--|------------------|
| 0                                      | GPIO Port A      |
| 1                                      | GPIO Port B      |
| 2                                      | GPIO Port C      |
| 3                                      | GPIO Port D      |
| 4                                      | GPIO Port E      |
| 5                                      | UART0            |
| 6                                      | UART1            |
| 7                                      | SSI              |
| 8                                      | I <sup>2</sup> C |
| 9                                      | Reserved         |
| 10                                     | Reserved         |
| 11                                     | Reserved         |
| 12                                     | Reserved         |

Table 4-2. Interrupts (Continued)

| Interrupt<br>(Bit in Interrupt Registers) | Description    |
|---|----------------|
| 13  | Reserved       |
| 14  | ADC Sequence 0 |
| 15  | ADC Sequence 1 |
| 16  | ADC Sequence 2 |
| 17  | ADC Sequence 3 |
| 18  | Watchdog timer |
| 19  | Timer0a        |
| 20  | Timer0b        |
| 21  | Timer1a        |
| 22  | Timer1b        |
| 23  | Timer2a        |
| 24  | Timer2b        |
| 25  | Reserved       |
| 26  | Reserved       |
| 27  | Reserved       |
| 28  | System Control |
| 29  | Flash Control  |
| 30  | Reserved       |
| 31  | Reserved       |

## 5 JTAG Interface

The Joint Test Action Group (JTAG) port is an IEEE standard that defines a Test Access Port and Boundary Scan Architecture for digital integrated circuits and provides a standardized serial interface for controlling the associated test logic. The TAP, Instruction Register (IR), and Data Registers (DR) can be used to test the interconnections of assembled printed circuit boards and obtain manufacturing information on the components. The JTAG Port also provides a means of accessing and controlling design-for-test features such as I/O pin observation and control, scan testing, and debugging.

The JTAG port is comprised of the standard five pins:  $\overline{\text{TRST}}$ , TCK, TMS, TDI, and TDO. Data is transmitted serially into the controller on TDI and out of the controller on TDO. The interpretation of this data is dependent on the current state of the TAP controller. For detailed information on the operation of the JTAG port and TAP controller, please refer to the *IEEE Standard 1149.1-Test Access Port and Boundary-Scan Architecture*.

The LMI JTAG controller works with the ARM JTAG controller built into the Cortex-M3 core. This is implemented by multiplexing the TDO outputs from both JTAG controllers. ARM JTAG instructions select the ARM TDO output while LMI JTAG instructions select the LMI TDO outputs. The multiplexer is controlled by the LMI JTAG controller, which has comprehensive programming for the ARM, LMI, and unimplemented JTAG instructions.

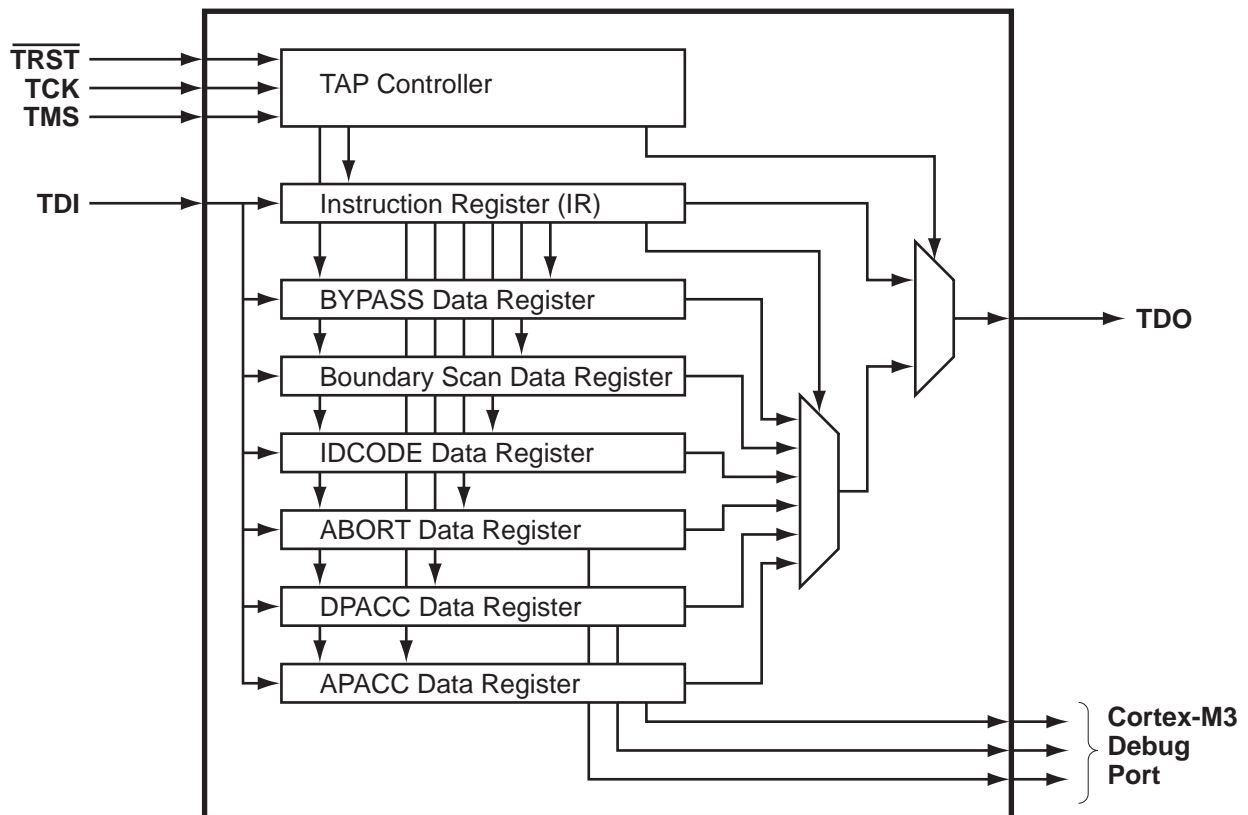
The JTAG module has the following features:

- IEEE 1149.1-1990 compatible Test Access Port (TAP) controller
- Four-bit Instruction Register (IR) chain for storing JTAG instructions
- IEEE standard instructions:
  - BYPASS instruction
  - IDCODE instruction
  - SAMPLE/PRELOAD instruction
  - EXTEST instruction
  - INTEST instruction
- ARM additional instructions:
  - APACC instruction
  - DPACC instruction
  - ABORT instruction
- Integrated ARM Serial Wire Debug (SWD)

See the *ARM® Cortex™-M3 Technical Reference Manual* for more information on the ARM JTAG controller.

## 5.1 Block Diagram

Figure 5-1. JTAG Module Block Diagram



## 5.2 Functional Description

A high-level conceptual drawing of the JTAG module is shown in Figure 5-1. The JTAG module is composed of the Test Access Port (TAP) controller and serial shift chains with parallel update registers. The TAP controller is a simple state machine controlled by the  $\overline{\text{TRST}}$ ,  $\text{TCK}$  and  $\text{TMS}$  inputs. The current state of the TAP controller depends on the current value of  $\overline{\text{TRST}}$  and the sequence of values captured on  $\text{TMS}$  at the rising edge of  $\text{TCK}$ . The TAP controller determines when the serial shift chains capture new data, shift data from  $\text{TDI}$  towards  $\text{TDO}$ , and update the parallel load registers. The current state of the TAP controller also determines whether the Instruction Register (IR) chain or one of the Data Register (DR) chains is being accessed.

The serial shift chains with parallel load registers are comprised of a single Instruction Register (IR) chain and multiple Data Register (DR) chains. The current instruction loaded in the parallel load register determines which DR chain is captured, shifted, or updated during the sequencing of the TAP controller.

Some instructions, like  $\text{EXTEST}$  and  $\text{INTEST}$ , operate on data currently in a DR chain and do not capture, shift, or update any of the chains. Instructions that are not implemented decode to the  $\text{BYPASS}$  instruction to ensure that the serial path between  $\text{TDI}$  and  $\text{TDO}$  is always connected (see Table 5-2 on page 44 for a list of implemented instructions).

See “JTAG and Boundary Scan” on page 346 for JTAG timing diagrams.

## 5.2.1 JTAG Interface Pins

The JTAG interface consists of five standard pins:  $\overline{\text{TRST}}$ , TCK, TMS, TDI, and TDO. These pins and their associated reset state are given in Table 5-1. Detailed information on each pin follows.

**Table 5-1. JTAG Port Pins Reset State**

| Pin Name                 | Data Direction | Internal Pull-Up | Internal Pull-Down | Drive Strength | Drive Value |
|--------------------------|----------------|------------------|--------------------|----------------|-------------|
| $\overline{\text{TRST}}$ | Input          | Enabled          | Disabled           | N/A            | N/A         |
| TCK                      | Input          | Enabled          | Disabled           | N/A            | N/A         |
| TMS                      | Input          | Enabled          | Disabled           | N/A            | N/A         |
| TDI                      | Input          | Enabled          | Disabled           | N/A            | N/A         |
| TDO                      | Output         | Enabled          | Disabled           | 2-mA driver    | High-Z      |

### 5.2.1.1 Test Reset Input ( $\overline{\text{TRST}}$ )

The  $\overline{\text{TRST}}$  pin is an asynchronous active Low input signal for initializing and resetting the JTAG TAP controller and associated JTAG circuitry. When  $\overline{\text{TRST}}$  is asserted, the TAP controller resets to the Test-Logic-Reset state and remains there while  $\overline{\text{TRST}}$  is asserted. When the TAP controller enters the Test-Logic-Reset state, the JTAG Instruction Register (IR) resets to the default instruction, IDCODE.

By default, the internal pull-up resistor on the  $\overline{\text{TRST}}$  pin is enabled after reset. Changes to the pull-up resistor settings on GPIO Port B should ensure that the internal pull-up resistor remains enabled on  $\text{PB7}/\overline{\text{TRST}}$ ; otherwise JTAG communication could be lost.

### 5.2.1.2 Test Clock Input (TCK)

The TCK pin is the clock for the JTAG module. This clock is provided so the test logic can operate independently of any other system clocks. In addition, it ensures that multiple JTAG TAP controllers that are daisy-chained together can synchronously communicate serial test data between components. During normal operation, TCK is driven by a free-running clock with a nominal 50% duty cycle. When necessary, TCK can be stopped at 0 or 1 for extended periods of time. While TCK is stopped at 0 or 1, the state of the TAP controller does not change and data in the JTAG Instruction and Data Registers is not lost.

By default, the internal pull-up resistor on the TCK pin is enabled after reset. This assures that no clocking occurs if the pin is not driven from an external source. The internal pull-up and pull-down resistors can be turned off to save internal power as long as the TCK pin is constantly being driven by an external source.

### 5.2.1.3 Test Mode Select (TMS)

The TMS pin selects the next state of the JTAG TAP controller. TMS is sampled on the rising edge of TCK. Depending on the current TAP state and the sampled value of TMS, the next state is entered. Because the TMS pin is sampled on the rising edge of TCK, the *IEEE Standard 1149.1* expects the value on TMS to change on the falling edge of TCK.

Holding TMS high for five consecutive TCK cycles drives the TAP controller state machine to the Test-Logic-Reset state. When the TAP controller enters the Test-Logic-Reset state, the JTAG Instruction Register (IR) resets to the default instruction, IDCODE. Therefore, this sequence can be used as a reset mechanism, similar to asserting  $\overline{\text{TRST}}$ . The JTAG Test Access Port state machine can be seen in its entirety in Figure 5-2 on page 42.



By default, the internal pull-up resistor on the TMS pin is enabled after reset. Changes to the pull-up resistor settings on GPIO Port C should ensure that the internal pull-up resistor remains enabled on PC1/TMS; otherwise JTAG communication could be lost.

#### 5.2.1.4 Test Data Input (TDI)

The TDI pin provides a stream of serial information to the IR chain and the DR chains. TDI is sampled on the rising edge of TCK and, depending on the current TAP state and the current instruction, presents this data to the proper shift register chain. Because the TDI pin is sampled on the rising edge of TCK, the *IEEE Standard 1149.1* expects the value on TDI to change on the falling edge of TCK.

By default, the internal pull-up resistor on the TDI pin is enabled after reset. Changes to the pull-up resistor settings on GPIO Port C should ensure that the internal pull-up resistor remains enabled on PC2/TDI; otherwise JTAG communication could be lost.

#### 5.2.1.5 Test Data Output (TDO)

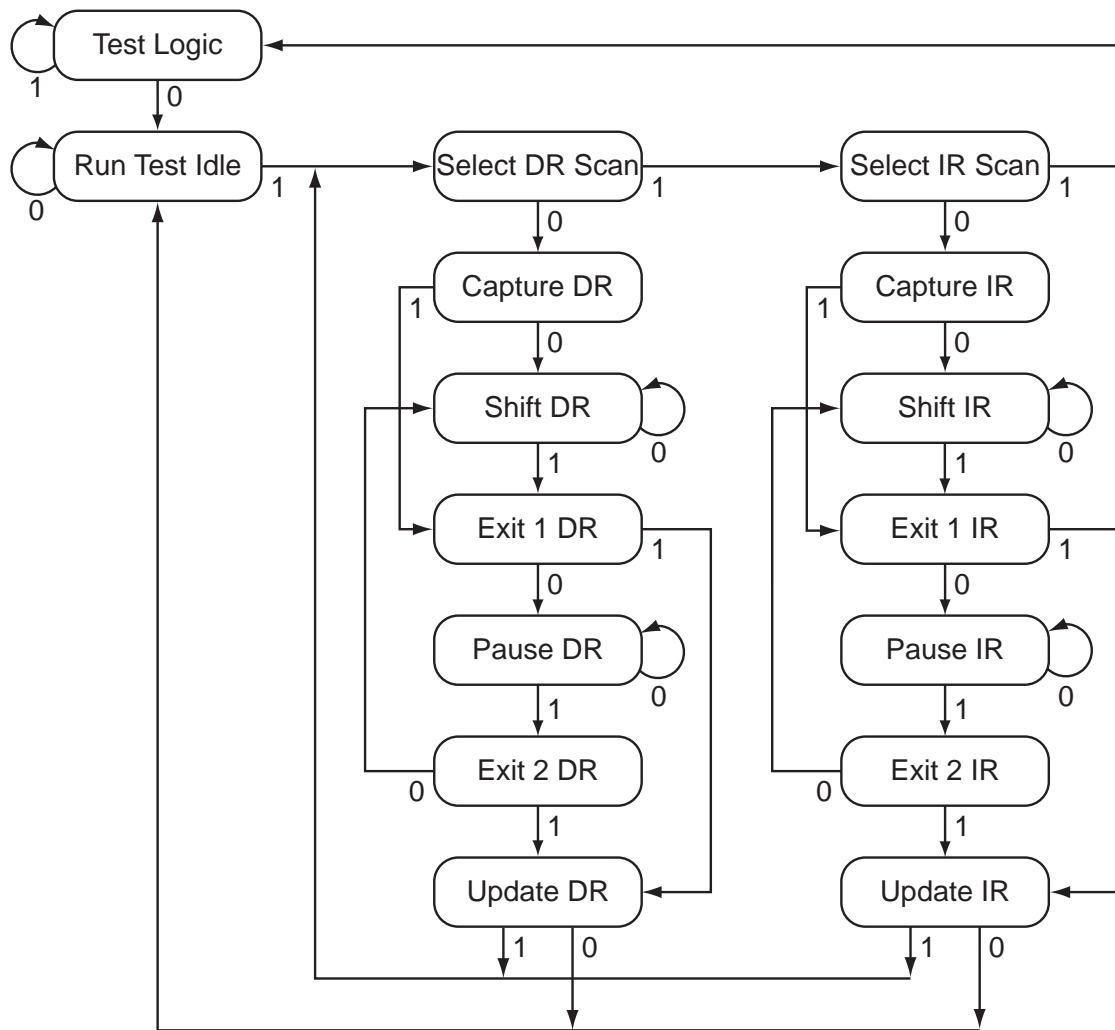
The TDO pin provides an output stream of serial information from the IR chain or the DR chains. The value of TDO depends on the current TAP state, the current instruction, and the data in the chain being accessed. In order to save power when the JTAG port is not being used, the TDO pin is placed in an inactive drive state when not actively shifting out data. Because TDO can be connected to the TDI of another controller in a daisy-chain configuration, the *IEEE Standard 1149.1* expects the value on TDO to change on the falling edge of TCK.

By default, the internal pull-up resistor on the TDO pin is enabled after reset. This assures that the pin remains at a constant logic level when the JTAG port is not being used. The internal pull-up and pull-down resistors can be turned off to save internal power if a High-Z output value is acceptable during certain TAP controller states.

### 5.2.2 JTAG TAP Controller

The JTAG TAP controller state machine is shown in Figure 5-2 on page 42. The TAP controller state machine is reset to the Test-Logic-Reset state on the assertion of a Power-On-Reset (POR) or the assertion of  $\overline{\text{TRST}}$ . Asserting the correct sequence on the TMS pin allows the JTAG module to shift in new instructions, shift in data, or idle during extended testing sequences. For detailed information on the function of the TAP controller and the operations that occur in each state, please refer to *IEEE Standard 1149.1*.

Figure 5-2. Test Access Port State Machine



### 5.2.3 Shift Registers

The Shift Registers consist of a serial shift register chain and a parallel load register. The serial shift register chain samples specific information during the TAP controller's CAPTURE states and allows this information to be shifted out of TDO during the TAP controller's SHIFT states. While the sampled data is being shifted out of the chain on TDO, new data is being shifted into the serial shift register on TDI. This new data is stored in the parallel load register during the TAP controller's UPDATE states. Each of the shift registers is discussed in detail in "Shift Registers" on page 42.

### 5.2.4 Operational Considerations

There are certain operational considerations when using the JTAG module. Because the JTAG pins can be programmed to be GPIOs, board configuration and reset conditions on these pins must be considered. In addition, because the JTAG module has integrated ARM Serial Wire Debug, the method for switching between these two operational modes requires clarification.

#### 5.2.4.1 GPIO Functionality

When the controller is reset with either a POR or  $\overline{RST}$ , the JTAG port pins default to their JTAG configurations. The default configuration includes enabling the pull-up resistors (setting **GPIOPUR**

to 1 for PB7 and PC[3:0]) and enabling the alternate hardware function (setting GPIOAFSEL to 1 for PB7 and PC[3:0]) on the JTAG pins.

It is possible for software to configure these pins as GPIOs after reset by writing 0s to PB7 and PC[3:0] in the GPIOAFSEL register. If the user does not require the JTAG port for debugging or board-level testing, this provides five more GPIOs for use in the design.

---

**Caution – If the JTAG pins are used as GPIOs in a design, PB7 and PC2 cannot have external pull-down resistors connected to both of them at the same time. If both pins are pulled Low during reset, the controller has unpredictable behavior. If this happens, remove one or both of the pull-down resistors, and apply RST or power-cycle the part**

**In addition, it is possible to create a software sequence that prevents the debugger from connecting to the Stellaris microcontroller. If the program code loaded into flash immediately changes the JTAG pins to their GPIO functionality, the debugger does not have enough time to connect and halt the controller before the JTAG pin functionality switches. This locks the debugger out of the part. This can be avoided with a software routine that restores JTAG functionality using an external trigger.**

---

#### 5.2.4.2 ARM Serial Wire Debug (SWD)

In order to seamlessly integrate the ARM Serial Wire Debug (SWD) functionality, a serial-wire debugger must be able to connect to the Cortex-M3 core without having to perform, or have any knowledge of, JTAG cycles. This is accomplished with a SWD preamble that is issued before the SWD session begins.

The preamble used to enable the SWD interface of the SWJ-DP module starts with the TAP controller in the Test-Logic-Reset state. From here, the preamble sequences the TAP controller through the following states: Run Test Idle, Select DR, Select IR, Capture IR, Exit1 IR, Update IR, Run Test Idle, Select DR, Select IR, Capture IR, Exit1 IR, Update IR, Run Test Idle, Select DR, Select IR, and Test-Logic-Reset states.

Stepping through the JTAG TAP Instruction Register (IR) load sequences of the TAP state machine twice without shifting in a new instruction enables the SWD interface and disables the JTAG interface. For more information on this operation and the SWD interface, see the *ARM® Cortex™-M3 Technical Reference Manual* and the *ARM® CoreSight Technical Reference Manual*.

Because this sequence is a valid series of JTAG operations that could be issued, the ARM JTAG TAP controller is not fully compliant to the *IEEE Standard 1149.1*. This is the only instance where the ARM JTAG TAP controller does not meet full compliance with the specification. Due to the low probability of this sequence occurring during normal operation of the TAP controller, it should not affect normal performance of the JTAG interface.

## 5.3 Initialization and Configuration

After a Power-On-Reset or an external reset ( $\overline{\text{RST}}$ ), the JTAG pins are automatically configured for JTAG communication. No user-defined initialization or configuration is needed. However, if the user application changes these pins to their GPIO function, they must be configured back to their JTAG functionality before JTAG communication can be restored. This is done by enabling the five JTAG pins (PB7 and PC[3:0]) for their alternate function using the GPIOAFSEL register.

## 5.4 Register Descriptions

There are no APB-accessible registers in the JTAG TAP Controller or Shift Register chains. The registers within the JTAG controller are all accessed serially through the TAP Controller. The registers can be broken down into two main categories: Instruction Registers and Data Registers.

### 5.4.1 Instruction Register (IR)

The JTAG TAP Instruction Register (IR) is a four-bit serial scan chain with a parallel load register connected between the JTAG TDI and TDO pins. When the TAP Controller is placed in the correct states, bits can be shifted into the Instruction Register. Once these bits have been shifted into the chain and updated, they are interpreted as the current instruction. The decode of the Instruction Register bits is shown in Table 5-2. A detailed explanation of each instruction, along with its associated Data Register, follows.

**Table 5-2. JTAG Instruction Register Commands**

| IR[3:0]    | Instruction      | Description  |
|------------|------------------|--|
| 0000       | EXTEST           | Drives the values preloaded into the Boundary Scan Chain by the SAMPLE/PRELOAD instruction onto the pads.                          |
| 0001       | INTEST           | Drives the values preloaded into the Boundary Scan Chain by the SAMPLE/PRELOAD instruction into the controller.                    |
| 0010       | SAMPLE / PRELOAD | Captures the current I/O values and shifts the sampled values out of the Boundary Scan Chain while new preload data is shifted in. |
| 1000       | ABORT            | Shifts data into the ARM Debug Port Abort Register.  |
| 1010       | DPACC            | Shifts data into and out of the ARM DP Access Register.  |
| 1011       | APACC            | Shifts data into and out of the ARM AC Access Register.  |
| 1110       | IDCODE           | Loads manufacturing information defined by the <i>IEEE Standard 1149.1</i> into the IDCODE chain and shifts it out.                |
| 1111       | BYPASS           | Connects TDI to TDO through a single Shift Register chain.   |
| All Others | Reserved         | Defaults to the BYPASS instruction to ensure that TDI is always connected to TDO.  |

#### 5.4.1.1 EXTEST Instruction

The EXTEST instruction does not have an associated Data Register chain. The EXTEST instruction uses the data that has been preloaded into the Boundary Scan Data Register using the SAMPLE/PRELOAD instruction. When the EXTEST instruction is present in the Instruction Register, the preloaded data in the Boundary Scan Data Register associated with the outputs and output enables are used to drive the GPIO pads rather than the signals coming from the core. This allows tests to be developed that drive known values out of the controller, which can be used to verify connectivity.

#### 5.4.1.2 INTEST Instruction

The INTEST instruction does not have an associated Data Register chain. The INTEST instruction uses the data that has been preloaded into the Boundary Scan Data Register using the SAMPLE/PRELOAD instruction. When the INTEST instruction is present in the Instruction Register, the preloaded data in the Boundary Scan Data Register associated with the inputs are used to drive the signals going into the core rather than the signals coming from the GPIO pads. This allows

tests to be developed that drive known values into the controller, which can be used for testing. It is important to note that although the  $\overline{\text{RST}}$  input pin is on the Boundary Scan Data Register chain, it is only observable.

#### 5.4.1.3 SAMPLE/PRELOAD Instruction

The SAMPLE/PRELOAD instruction connects the Boundary Scan Data Register chain between TDI and TDO. This instruction samples the current state of the pad pins for observation and preloads new test data. Each GPIO pad has an associated input, output, and output enable signal. When the TAP controller enters the Capture DR state during this instruction, the input, output, and output-enable signals to each of the GPIO pads are captured. These samples are serially shifted out of TDO while the TAP controller is in the Shift DR state and can be used for observation or comparison in various tests.

While these samples of the inputs, outputs, and output enables are being shifted out of the Boundary Scan Data Register, new data is being shifted into the Boundary Scan Data Register from TDI. Once the new data has been shifted into the Boundary Scan Data Register, the data is saved in the parallel load registers when the TAP controller enters the Update DR state. This update of the parallel load register preloads data into the Boundary Scan Data Register that is associated with each input, output, and output enable. This preloaded data can be used with the EXTEST and INTEST instructions to drive data into or out of the controller. Please see “Boundary Scan Data Register” on page 46 for more information.

#### 5.4.1.4 ABORT Instruction

The ABORT instruction connects the associated ABORT Data Register chain between TDI and TDO. This instruction provides read and write access to the ABORT Register of the ARM Debug Access Port (DAP). Shifting the proper data into this Data Register clears various error bits or initiates a DAP abort of a previous request. Please see the “ABORT Data Register” on page 47 for more information.

#### 5.4.1.5 DPACC Instruction

The DPACC instruction connects the associated DPACC Data Register chain between TDI and TDO. This instruction provides read and write access to the DPACC Register of the ARM Debug Access Port (DAP). Shifting the proper data into this register and reading the data output from this register allows read and write access to the ARM debug and status registers. Please see “DPACC Data Register” on page 47 for more information.

#### 5.4.1.6 APACC Instruction

The APACC instruction connects the associated APACC Data Register chain between TDI and TDO. This instruction provides read and write access to the APACC Register of the ARM Debug Access Port (DAP). Shifting the proper data into this register and reading the data output from this register allows read and write access to internal components and buses through the Debug Port. Please see “APACC Data Register” on page 47 for more information.

#### 5.4.1.7 IDCODE Instruction

The IDCODE instruction connects the associated IDCODE Data Register chain between TDI and TDO. This instruction provides information on the manufacturer, part number, and version of the ARM core. This information can be used by testing equipment and debuggers to automatically configure their input and output data streams. IDCODE is the default instruction that is loaded into the JTAG Instruction Register when a power-on-reset (POR) is asserted,  $\overline{\text{TRST}}$  is asserted, or the Test-Logic-Reset state is entered. Please see “IDCODE Data Register” on page 46 for more information.

**5.4.1.8 BYPASS Instruction**

The BYPASS instruction connects the associated BYPASS Data Register chain between TDI and TDO. This instruction is used to create a minimum length serial path between the TDI and TDO ports. The BYPASS Data Register is a single-bit shift register. This instruction improves test efficiency by allowing components that are not needed for a specific test to be bypassed in the JTAG scan chain by loading them with the BYPASS instruction. Please see “BYPASS Data Register” on page 46 for more information.

**5.4.2 Data Registers**

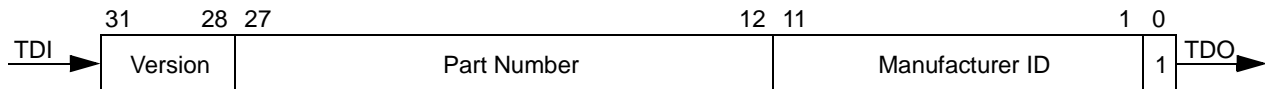
The JTAG module contains six Data Registers. These include: IDCODE, BYPASS, Boundary Scan, APACC, DPACC, and ABORT serial Data Register chains. Each of these Data Registers is discussed in the following sections.

**5.4.2.1 IDCODE Data Register**

The format for the 32-bit IDCODE Data Register defined by the *IEEE Standard 1149.1* is shown in Figure 5-3. The standard requires that every JTAG-compliant device implement either the IDCODE instruction or the BYPASS instruction as the default instruction. The LSB of the IDCODE Data Register is defined to be a 1 to distinguish it from the BYPASS instruction, which has an LSB of 0. This allows auto configuration test tools to determine which instruction is the default instruction.

The major uses of the JTAG port are for manufacturer testing of component assembly, and program development and debug. To facilitate the use of auto-configuration debug tools, the IDCODE instruction outputs a value of 0x1BA00477. This value indicates an ARM Cortex-M3, Version 1 processor. This allows the debuggers to automatically configure themselves to work correctly with the Cortex-M3 during debug.

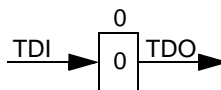
**Figure 5-3. IDCODE Register Format**



**5.4.2.2 BYPASS Data Register**

The format for the 1-bit BYPASS Data Register defined by the *IEEE Standard 1149.1* is shown in Figure 5-4. The standard requires that every JTAG-compliant device implement either the BYPASS instruction or the IDCODE instruction as the default instruction. The LSB of the BYPASS Data Register is defined to be a 0 to distinguish it from the IDCODE instruction, which has an LSB of 1. This allows auto configuration test tools to determine which instruction is the default instruction.

**Figure 5-4. BYPASS Register Format**



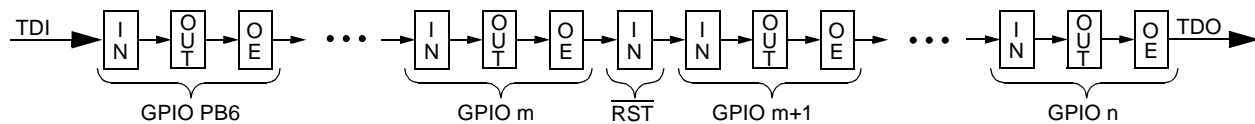
**5.4.2.3 Boundary Scan Data Register**

The format of the Boundary Scan Data Register is shown in Figure 5-5. Each GPIO pin, in a counter-clockwise direction from the JTAG port pins, is included in the Boundary Scan Data Register. Each GPIO pin has three associated digital signals that are included in the chain. These

signals are input, output, and output enable, and are arranged in that order as can be seen in the figure. In addition to the GPIO pins, the controller reset pin,  $\overline{RST}$ , is included in the chain. Because the reset pin is always an input, only the input signal is included in the Data Register chain.

When the Boundary Scan Data Register is accessed with the SAMPLE/PRELOAD instruction, the input, output, and output enable from each digital pad are sampled and then shifted out of the chain to be verified. The sampling of these values occurs on the rising edge of  $TCK$  in the Capture DR state of the TAP controller. While the sampled data is being shifted out of the Boundary Scan chain in the Shift DR state of the TAP controller, new data can be preloaded into the chain for use with the EXTEST and INTEST instructions. These instructions either force data out of the controller, with the EXTEST instruction, or into the controller, with the INTEST instruction.

**Figure 5-5. Boundary Scan Register Format**



For detailed information on the order of the input, output, and output enable bits for each of the GPIO ports, please refer to the Stellaris Family Boundary Scan Description Language (BSDL) files, downloadable from [www.luminarymicro.com](http://www.luminarymicro.com).

#### 5.4.2.4 APACC Data Register

The format for the 35-bit APACC Data Register defined by ARM is described in the *ARM® Cortex™-M3 Technical Reference Manual*.

#### 5.4.2.5 DPACC Data Register

The format for the 35-bit DPACC Data Register defined by ARM is described in the *ARM® Cortex™-M3 Technical Reference Manual*.

#### 5.4.2.6 ABORT Data Register

The format for the 35-bit ABORT Data Register defined by ARM is described in the *ARM® Cortex™-M3 Technical Reference Manual*.

## 6 System Control

System control determines the overall operation of the device. It provides information about the device, controls the clocking of the device and individual peripherals, and handles reset detection and reporting.

### 6.1 Functional Description

The System Control module provides the following capabilities:

- Device identification, see page 48
- Local control, such as reset (see page 48), power (see page 51) and clock control (see page 51)
- System control (Run, Sleep, and Deep-Sleep modes), see page 53

#### 6.1.1 Device Identification

Seven read-only registers provide software with information on the microcontroller, such as version, part number, SRAM size, Flash size, and other features. See the **DID0**, **DID1** and **DC0-DC4** registers starting on page 56.

#### 6.1.2 Reset Control

This section discusses aspects of hardware functions during reset as well as system software requirements following the reset sequence.

##### 6.1.2.1 Reset Sources

The controller has six sources of reset:

1. External reset input pin ( $\overline{\text{RST}}$ ) assertion, see page 48.
2. Power-on reset (POR), see page 49.
3. Internal brown-out (BOR) detector, see page 49.
4. Software-initiated reset (with the software reset registers), see page 50.
5. A watchdog timer reset condition violation, see page 50.
6. Internal low drop-out (LDO) regulator output, see page 51.

After a reset, the **Reset Cause (RESC)** register (see page 74) is set with the reset cause. The bits in this register are sticky and maintain their state across multiple reset sequences, except when an external reset is the cause, and then all the other bits in the **RESC** register are cleared.

**Note:** The main oscillator is used for external resets and power-on resets; the internal oscillator is used during the internal process by internal reset and clock verification circuitry.

##### 6.1.2.2 $\overline{\text{RST}}$ Pin Assertion

The external reset pin ( $\overline{\text{RST}}$ ) resets the controller. This resets the core and all the peripherals except the JTAG TAP controller (see “JTAG Interface” on page 38). The external reset sequence is as follows:

1. The external reset pin ( $\overline{\text{RST}}$ ) is asserted and then de-asserted.
2. After  $\overline{\text{RST}}$  is de-asserted, the main crystal oscillator must be allowed to settle and there is an internal main oscillator counter that takes from 15-30 ms to account for this. During this time, internal reset to the rest of the controller is held active.



3. The internal reset is released and the controller fetches and loads the initial stack pointer, the initial program counter, and the first instruction designated by the program counter, and then begins execution.

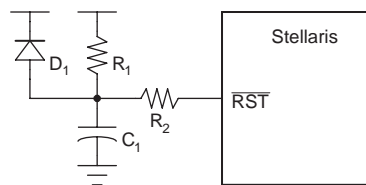
The external reset timing is shown in Figure 18-9 on page 349.

### 6.1.2.3 Power-On Reset (POR)

The Power-On Reset (POR) circuitry detects a rise in power-supply voltage and generates an on-chip reset pulse. To use the on-chip circuitry, the  $\overline{\text{RST}}$  input needs a pull-up resistor (1K to 10K  $\Omega$ ).

The device must be operating within the specified operating parameters at the point when the on-chip power-on reset pulse is complete. The specified operating parameters include supply voltage, frequency, temperature, and so on. If the operating conditions are not met at the point of POR end, the Stellaris controller does not operate correctly. In this case, the reset must be extended using external circuitry. The  $\overline{\text{RST}}$  input may be used with the circuit as shown in Figure 6-1.

**Figure 6-1. External Circuitry to Extend Reset**



The  $R_1$  and  $C_1$  components define the power-on delay. The  $R_2$  resistor mitigates any leakage from the  $\overline{\text{RST}}$  input. The diode discharges  $C_1$  rapidly when the power supply is turned off.

The Power-On Reset sequence is as follows:

1. The controller waits for the later of external reset ( $\overline{\text{RST}}$ ) or internal POR to go inactive.
2. After the resets are inactive, the main crystal oscillator must be allowed to settle and there is an internal main oscillator counter that takes from 15-30 ms to account for this. During this time, internal reset to the rest of the controller is held active.
3. The internal reset is released and the controller fetches and loads the initial stack pointer, the initial program counter, and the first instruction designated by the program counter, and then begins execution.

The internal POR is only active on the initial power-up of the controller. The Power-On Reset timing is shown in Figure 18-10 on page 349.

### 6.1.2.4 Brown-Out Reset (BOR)

A drop in the input voltage resulting in the assertion of the internal brown-out detector can be used to reset the controller. This is initially disabled and may be enabled by software.

The system provides a brown-out detection circuit that triggers if  $V_{DD}$  drops below  $V_{BTH}$ . The circuit is provided to guard against improper operation of logic and peripherals that operate off  $V_{DD}$  and not the LDO voltage. If a brown-out condition is detected, the system may generate a controller interrupt or a system reset. The BOR circuit has a digital filter that protects against noise-related detection. This feature may be optionally enabled.

Brown-out resets are controlled with the **Power-On and Brown-Out Reset Control (PBORCTL)** register (see page 65). The **BORIOR** bit in the **PBORCTL** register must be set for a brown-out to trigger a reset. The brown-out reset sequence is as follows:

1. When  $V_{DD}$  drops below  $V_{BTH}$ , an internal BOR condition is set.
2. If the **BORWT** bit in the **PBORCTL** register is set, the BOR condition is resampled sometime later (specified by **BORTIM**) to determine if the original condition was caused by noise. If the BOR condition is not met the second time, then no action is taken.
3. If the BOR condition exists, an internal reset is asserted.
4. The internal reset is released and the controller fetches and loads the initial stack pointer, the initial program counter, and the first instruction designated by the program counter, and then begins execution.
5. The internal  $\overline{BOR}$  signal is released after 500  $\mu$ s to prevent another BOR condition from being set before software has a chance to investigate the original cause.

The internal Brown-Out Reset timing is shown in Figure 18-11 on page 349.

#### 6.1.2.5 Software Reset

Each peripheral can be reset by software. There are three registers that control this function (see the **SRCRn** registers, starting on page 67). If the bit position corresponding to a peripheral is set, the peripheral is reset. The encoding of the reset registers is consistent with the encoding of the clock gating control for peripherals and on-chip functions (see “System Control” on page 53). Writing a bit lane with a value of 1 initiates a reset of the corresponding unit. Note that all reset signals for all clocks of the specified unit are asserted as a result of a software-initiated reset.

The entire system can be reset by software also. Setting the **SYSRESETREQ** bit in the Cortex-M3 Application Interrupt and Reset Control register resets the entire system including the core. The software-initiated system reset sequence is as follows:

1. A software system reset is initiated by writing the **SYSRESETREQ** bit in the ARM Cortex-M3 Application Interrupt and Reset Control register.
2. An internal reset is asserted.
3. The internal reset is released and the controller fetches and loads the initial stack pointer, the initial program counter, and the first instruction designated by the program counter, and then begins execution.

The software-initiated system reset timing is shown in Figure 18-12 on page 349.

#### 6.1.2.6 Watchdog Timer Reset

The watchdog timer module's function is to prevent system hangs. The watchdog timer can be configured to generate an interrupt to the controller on its first time-out, and to generate a reset signal on its second time-out.

After the first time-out event, the 32-bit counter is reloaded with the value of the **Watchdog Timer Load (WDTLOAD)** register (see page 175), and the timer resumes counting down from that value. If the timer counts down to its zero state again before the first time-out interrupt is cleared, and the reset signal has been enabled, the watchdog timer asserts its reset signal to the system. The watchdog timer reset sequence is as follows:

1. The watchdog timer times out for the second time without being serviced.
2. An internal reset is asserted.

3. The internal reset is released and the controller fetches and loads the initial stack pointer, the initial program counter, and the first instruction designated by the program counter, and then begins execution.

The watchdog reset timing is shown in Figure 18-13 on page 350.

#### 6.1.2.7 Low Drop-Out

A reset can be made when the internal low drop-out (LDO) regulator output goes unregulated. This is initially disabled and may be enabled by software. LDO is controlled with the **LDO Power Control (LDOPCTL)** register (see page 66). The LDO reset sequence is as follows:

1. LDO goes unregulated and the `LDOARST` bit in the **LDOARST** register is set.
2. An internal reset is asserted.
3. The internal reset is released and the controller fetches and loads the initial stack pointer, the initial program counter, and the first instruction designated by the program counter, and then begins execution.

The LDO reset timing is shown in Figure 18-14 on page 350.

### 6.1.3 Power Control

The LDO regulator permits the adjustment of the on-chip output voltage ( $V_{OUT}$ ). The output may be adjusted in 50 mV increments between the range of 2.25 V through 2.75 V. The adjustment is made through the `VADJ` field of the **LDO Power Control (LDOPCTL)** register (see page 66).

### 6.1.4 Clock Control

System control determines the clocking and control of clocks in this part.

#### 6.1.4.1 Fundamental Clock Sources

There are two fundamental clock sources for use in the device:

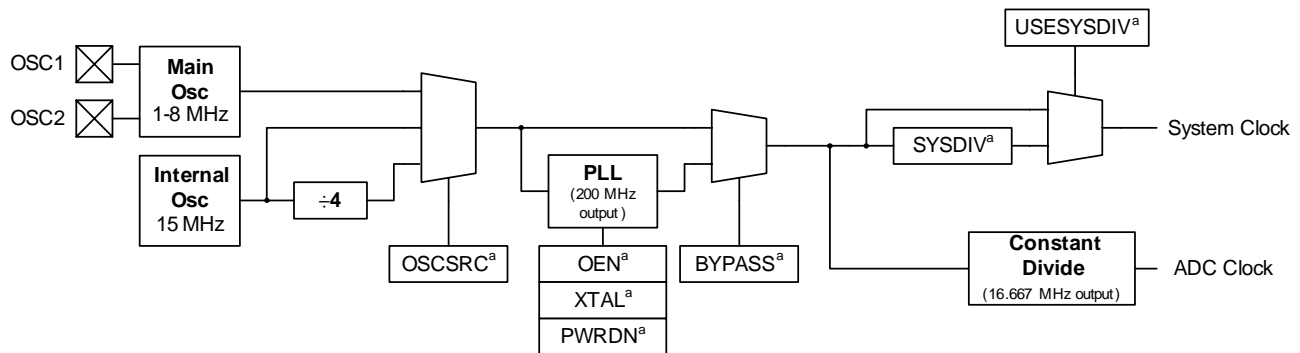
- The main oscillator, driven from either an external crystal or a single-ended source. As a crystal, the main oscillator source is specified to run from 1-8 MHz. However, when the crystal is being used as the PLL source, it must be from 3.579545–8.192 MHz to meet PLL requirements. As a single-ended source, the range is from DC to the specified speed of the device.
- The internal oscillator, which is an on-chip free running clock. The internal oscillator is specified to run at 12 MHz  $\pm$  50%. It can be used to clock the system, but the tolerance of frequency range must be met.

The internal system clock may be driven by either of the above two reference sources as well as the internal PLL, provided that the PLL input is connected to a clock source that meets its AC requirements.

Nearly all of the control for the clocks is provided by the **Run-Mode Clock Configuration (RCC)** register (see page 75).

Figure 6-2 shows the logic for the main clock tree. The peripheral blocks are driven by the System Clock signal and can be programmatically enabled/disabled. The ADC clock signal is automatically divided down to 14-18 MHz for proper ADC operation.

Figure 6-2. Main Clock Tree



a. These are bit fields within the **Run-Mode Clock Configuration(RCC)** register.

#### 6.1.4.2 PLL Frequency Configuration

The user does not have direct control over the PLL frequency, but is required to match the external crystal used to an internal PLL-Crystal table. This table is used to create the best fit for PLL parameters to the crystal chosen. Not all crystals result in the PLL operating at exactly 200 MHz, though the frequency is within  $\pm 1\%$ . The result of the lookup is kept in the **XTAL to PLL Translation (PLLCTL)** register (see page 79).

Table 6-4 on page 78 describes the available crystal choices and default programming of the **PLLCTL** register. The crystal number is written into the **XTAL** field of the **Run-Mode Clock Configuration (RCC)** register (see page 75). Any time the **XTAL** field changes, a read of the internal table is performed to get the correct value. Table 6-4 on page 78 describes the available crystal choices and default programming values.

#### 6.1.4.3 PLL Modes

The PLL has two modes of operation: Normal and Power-Down

- Normal: The PLL multiplies the input clock reference and drives the output.
- Power-Down: Most of the PLL internal circuitry is disabled and the PLL does not drive the output.

The modes are programmed using the **RCC** register fields as shown in Table 6-4 on page 78.

#### 6.1.4.4 PLL Operation

If the PLL configuration is changed, the PLL output is not stable for a period of time (PLL  $T_{\text{READY}}=0.5$  ms) and during this time, the PLL is not usable as a clock reference.

The PLL is changed by one of the following:

- Change to the **XTAL** value in the **RCC** register (see page 75)—writes of the same value do not cause a relock.
- Change in the PLL from Power-Down to Normal mode.

A counter is defined to measure the  $T_{\text{READY}}$  requirement. The counter is clocked by the main oscillator. The range of the main oscillator has been taken into account and the down counter is set to 0x1200 (that is,  $\sim 600$   $\mu\text{s}$  at a 8.192-MHz external oscillator clock). Hardware is provided to keep the PLL from being used as a system clock until the  $T_{\text{READY}}$  condition is met after one of the

two changes above. It is the user's responsibility to have a stable clock source (like the main oscillator) before the **RCC** register is switched to use the PLL.

#### 6.1.4.5 Clock Verification Timers

There are three identical clock verification circuits that can be enabled through software. The circuit checks the faster clock by a slower clock using timers:

- The main oscillator checks the PLL.
- The main oscillator checks the internal oscillator.
- The internal oscillator divided by 64 checks the main oscillator.

If the verification timer function is enabled and a failure is detected, the main clock tree is immediately switched to a working clock and an interrupt is generated to the controller. Software can then determine the course of action to take. The actual failure indication and clock switching does not clear without a write to the **CLKVCLR** register, an external reset, or a POR reset. The clock verification timers are controlled by the **PLLVER**, **IOSCVR**, and **MOSCVR** bits in the **RCC** register (see page 75).

### 6.1.5 System Control

For power-savings purposes, the **RCGCn**, **SCGCn**, and **DCGCn** registers control the clock gating logic for each peripheral or block in the system while the controller is in Run, Sleep, and Deep-Sleep mode, respectively. The **DC1**, **DC2** and **DC4** registers act as a write mask for the **RCGCn**, **SCGCn**, and **DCGCn** registers.

In Run mode, the controller is actively executing code. In Sleep mode, the clocking of the device is unchanged but the controller no longer executes code (and is no longer clocked). In Deep-Sleep mode, the clocking of the device may change (depending on the Run mode clock configuration) and the controller no longer executes code (and is no longer clocked). An interrupt returns the device to Run mode from one of the sleep modes; the sleep modes are entered on request from the code. Each mode is described in more detail in this section.

#### 6.1.5.1 Run Mode

Run mode provides normal operation of the processor and all of the peripherals that are currently enabled by the **RCGCn** registers. The system clock can be any of the available clock sources including the PLL.

#### 6.1.5.2 Sleep Mode

In Sleep mode, the Cortex-M3 processor core and the memory subsystem are not clocked. Peripherals are clocked that are enabled in the **SCGCn** register when Auto Clock Gating is enabled (see **RCC** register on page 75) or the **RCGCn** register when the Auto Clock Gating is disabled. The System Clock has the same source and frequency as that during Run mode.

#### 6.1.5.3 Deep-Sleep Mode

The Cortex-M3 processor core and the memory subsystem are not clocked. Peripherals are clocked that are enabled in the **DCGCn** register when Auto Clock Gating is enabled (see **RCC** register) or the **RCGCn** register when the Auto Clock Gating is disabled. The system clock source is the main oscillator by default or the internal oscillator specified in the **DSLPCCLKCFG** register if one is enabled (see page 85). When the **DSLPCCLKCFG** register is used, the internal oscillator is powered up, if necessary, and the main oscillator is powered down. If the PLL is running at the time of the WFI instruction, hardware powers the PLL down and overrides the **SYSDIV** field of the active **RCC** register to be /16 or /64 respectively. When the Deep-Sleep exit event occurs, hardware brings the system clock back to the source and frequency it had at the onset of Deep-Sleep mode before enabling the clocks that were stopped during the Deep-Sleep duration.

## 6.2 Initialization and Configuration

The PLL is configured using direct register writes to the **Run-Mode Clock Configuration (RCC)** register. The steps required to successfully change the PLL-based system clock are:

1. Bypass the PLL and system clock divider by setting the `BYPASS` bit and clearing the `USESYS` bit in the **RCC** register. This configures the system to run off a “raw” clock source (using the main oscillator or internal oscillator) and allows for the new PLL configuration to be validated before switching the system clock to the PLL.
2. Select the crystal value (`XTAL`) and oscillator source (`OSCSRC`), and clear the `PWRDN` and `OE` bits in **RCC**. Setting the `XTAL` field automatically pulls valid PLL configuration data for the appropriate crystal, and clearing the `PWRDN` and `OE` bits powers and enables the PLL and its output.
3. Select the desired system divider (`SYSDIV`) and set the `USESYS` bit in **RCC**. The `SYSDIV` field determines the system frequency for the microcontroller.
4. Wait for the PLL to lock by polling the `PLLLRIS` bit in the **Raw Interrupt Status (RIS)** register. If the PLL doesn’t lock, the configuration is invalid.
5. Enable use of the PLL by clearing the `BYPASS` bit in **RCC**.

**Important:** If the `BYPASS` bit is cleared before the PLL locks, it is possible to render the device unusable.

## 6.3 Register Map

Table 6-1 lists the System Control registers, grouped by function. The offset listed is a hexadecimal increment to the register’s address, relative to the System Control base address of 0x400FE000.

**Table 6-1. System Control Register Map (Sheet 1 of 2)**

| Offset  | Name    | Reset      | Type | Description                          | See page |
|---|---------|------------|------|--------------------------------------|----------|
| <b>Device Identification and Capabilities</b> |         |            |      |                                      |          |
| 0x000   | DID0    | -          | RO   | Device identification 0              | 56       |
| 0x004   | DID1    | -          | RO   | Device identification 1              | 57       |
| 0x008   | DC0     | 0x001F000F | RO   | Device capabilities 0                | 59       |
| 0x010   | DC1     | 0x00000003 | RO   | Device capabilities 1                | 60       |
| 0x014   | DC2     | 0x00071013 | RO   | Device capabilities 2                | 62       |
| 0x018   | DC3     | 0xFFF0000  | RO   | Device Capabilities 3                | 63       |
| 0x01C   | DC4     | 0x0000001F | RO   | Device Capabilities 4                | 64       |
| <b>Local Control</b>                          |         |            |      |                                      |          |
| 0x030   | PBORCTL | 0x00007FFD | R/W  | Power-On and Brown-Out Reset Control | 65       |
| 0x034   | LDOPCTL | 0x00000000 | R/W  | LDO Power Control                    | 66       |
| 0x040   | SRCR0   | 0x00000000 | R/W  | Software Reset Control 0             | 67       |

Table 6-1. System Control Register Map (Sheet 2 of 2)

| Offset                | Name      | Reset      | Type  | Description                             | See page |
|-----------------------|-----------|------------|-------|---|----------|
| 0x044                 | SRCR1     | 0x00000000 | R/W   | Software Reset Control 1                | 68       |
| 0x048                 | SRCR2     | 0x00000000 | R/W   | Software Reset Control 2                | 69       |
| 0x050                 | RIS       | 0x00000000 | RO    | Raw Interrupt Status                    | 70       |
| 0x054                 | IMC       | 0x00000000 | R/W   | Interrupt Mask Control                  | 71       |
| 0x058                 | MISC      | 0x00000000 | R/W1C | Masked Interrupt Status and Clear       | 73       |
| 0x05C                 | RESC      | -          | R/W   | Reset Cause                             | 74       |
| 0x060                 | RCC       | 0x07803AC0 | R/W   | Run-Mode Clock Configuration            | 75       |
| 0x064                 | PLLCFG    | -          | RO    | XTAL to PLL translation                 | 79       |
| <b>System Control</b> |           |            |       |   |          |
| 0x100                 | RCGC0     | 0x00000001 | R/W   | Run-Mode Clock Gating Control 0         | 80       |
| 0x104                 | RCGC1     | 0x00000000 | R/W   | Run-Mode Clock Gating Control 1         | 82       |
| 0x108                 | RCGC2     | 0x00000000 | R/W   | Run-Mode Clock Gating Control 2         | 84       |
| 0x110                 | SCGC0     | 0x00000001 | R/W   | Sleep-Mode Clock Gating Control 0       | 80       |
| 0x114                 | SCGC1     | 0x00000000 | R/W   | Sleep-Mode Clock Gating Control 1       | 82       |
| 0x118                 | SCGC2     | 0x00000000 | R/W   | Sleep-Mode Clock Gating Control 2       | 84       |
| 0x120                 | DCGC0     | 0x00000001 | R/W   | Deep-Sleep-Mode Clock Gating Control 0  | 80       |
| 0x124                 | DCGC1     | 0x00000000 | R/W   | Deep-Sleep-Mode Clock Gating Control 1  | 82       |
| 0x128                 | DCGC2     | 0x00000000 | R/W   | Deep-Sleep-Mode Clock Gating Control 2  | 84       |
| 0x144                 | DSLCLKCFG | 0x07800000 | R/W   | Deep-Sleep Clock Configuration          | 85       |
| 0x150                 | CLKVCLR   | 0x00000000 | R/W   | Clock verification clear                | 86       |
| 0x160                 | LDOARST   | 0x00000000 | R/W   | Allow unregulated LDO to reset the part | 87       |

## 6.4 Register Descriptions

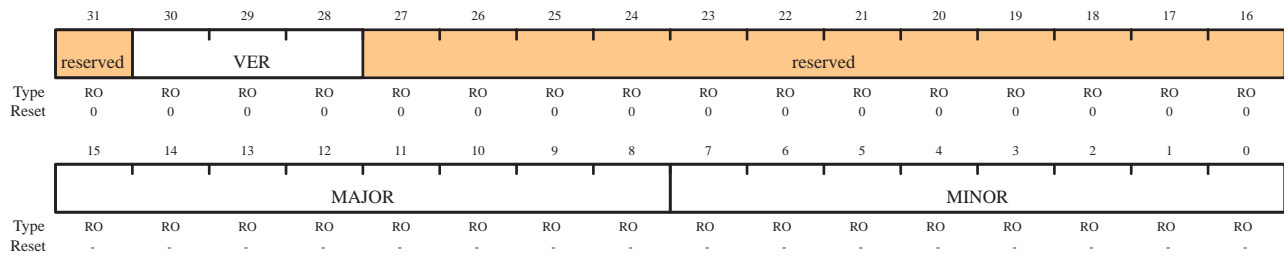
The remainder of this section lists and describes the System Control registers, in numerical order by address offset.

**Register 1: Device Identification 0 (DID0), offset 0x000**

This register identifies the version of the device.

Device Identification 0 (DID0)

Offset 0x000



| Bit/Field | Name     | Type | Reset | Description  |
|-----------|----------|------|-------|--|
| 31        | reserved | RO   | 0     | Reserved bits return an indeterminate value, and should never be changed.  |
| 30:28     | VER      | RO   | 0     | This field defines the version of the <b>DID0</b> register format:<br>0=Register version for the Stellaris microcontrollers  |
| 27:16     | reserved | RO   | 0     | Reserved bits return an indeterminate value, and should never be changed.  |
| 15:8      | MAJOR    | RO   | -     | This field specifies the major revision number of the device. The major revision number is indicated in the part number as a letter (A for first revision, B for second, and so on). This field is encoded as follows:<br>0: Revision A (initial device)<br>1: Revision B (first revision)<br>and so on.                         |
| 7:0       | MINOR    | RO   | -     | This field specifies the minor revision number of the device. This field is numeric and is encoded as follows:<br>0: No changes. Major revision was most recent update.<br>1: One interconnect change made since last major revision update.<br>2: Two interconnect changes made since last major revision update.<br>and so on. |



**Register 2: Device Identification 1 (DID1), offset 0x004**

This register identifies the device family, part number, temperature range, and package type.

**Note:** The bit diagram indicates some values are device-specific. The table below indicates values for your part.

Device Identification 1 (DID1)  
Offset 0x004

|       |          |    |    |    |     |    |     |     |        |    |    |     |    |      |      |    |
|-------|----------|----|----|----|-----|----|-----|-----|--------|----|----|-----|----|------|------|----|
|       | 31       | 30 | 29 | 28 | 27  | 26 | 25  | 24  | 23     | 22 | 21 | 20  | 19 | 18   | 17   | 16 |
|       | VER      |    |    |    | FAM |    |     |     | PARTNO |    |    |     |    |      |      |    |
| Type  | RO       | RO | RO | RO | RO  | RO | RO  | RO  | RO     | RO | RO | RO  | RO | RO   | RO   | RO |
| Reset | 0        | 0  | 0  | 0  | 0   | 0  | 0   | 0   | -      | -  | -  | -   | -  | -    | -    | -  |
|       | 15       | 14 | 13 | 12 | 11  | 10 | 9   | 8   | 7      | 6  | 5  | 4   | 3  | 2    | 1    | 0  |
|       | reserved |    |    |    |     |    |     |     | TEMP   |    |    | PKG |    | RoHS | QUAL |    |
| Type  | RO       | RO | RO | RO | RO  | RO | R/W | R/W | RO     | RO | RO | RO  | RO | RO   | RO   | RO |
| Reset | 0        | 0  | 0  | 0  | 0   | 0  | 0   | 0   | -      | -  | -  | 0   | 1  | 1    | -    | -  |

| Bit/Field | Name   | Type | Reset     | Description  |      |             |     |  |     |  |         |          |
|-----------|--|------|-----------|--|------|-------------|-----|--|-----|--|---------|----------|
| 31:28     | VER  | RO   | 0x0       | This field defines the version of the <b>DID1</b> register format:<br>0=Register version for the Stellaris microcontrollers  |      |             |     |  |     |  |         |          |
| 27:24     | FAM  | RO   | 0x0       | Family<br><br>This field provides the family identification of the device within the Luminary Micro product portfolio.<br><br>The 0x0 value indicates the Stellaris family of microcontrollers.  |      |             |     |  |     |  |         |          |
| 23:16     | PARTNO                                       | RO   | 0x27      | Part Number<br><br>This field provides the part number of the device within the family.<br><br>The 0x27 value indicates the LM3S628 microcontroller.   |      |             |     |  |     |  |         |          |
| 15:8      | reserved                                     | RO   | 0         | Reserved bits return an indeterminate value, and should never be changed.  |      |             |     |  |     |  |         |          |
| 7:5       | TEMP   | RO   | see table | Temperature Range<br><br>This field specifies the temperature rating of the device. This field is encoded as follows:<br><br><table border="1"> <thead> <tr> <th>TEMP</th> <th>Description</th> </tr> </thead> <tbody> <tr> <td>000</td> <td>Commercial temperature range (0°C to 70°C)</td> </tr> <tr> <td>001</td> <td>Industrial temperature range (-40°C to 85°C)</td> </tr> <tr> <td>010-111</td> <td>Reserved</td> </tr> </tbody> </table> | TEMP | Description | 000 | Commercial temperature range (0°C to 70°C) | 001 | Industrial temperature range (-40°C to 85°C) | 010-111 | Reserved |
| TEMP      | Description                                  |      |           |  |      |             |     |  |     |  |         |          |
| 000       | Commercial temperature range (0°C to 70°C)   |      |           |  |      |             |     |  |     |  |         |          |
| 001       | Industrial temperature range (-40°C to 85°C) |      |           |  |      |             |     |  |     |  |         |          |
| 010-111   | Reserved                                     |      |           |  |      |             |     |  |     |  |         |          |
| 4:3       | PKG  | RO   | 0x1       | This field specifies the package type. A value of 1 indicates a 48-pin LQFP package.   |      |             |     |  |     |  |         |          |

## System Control

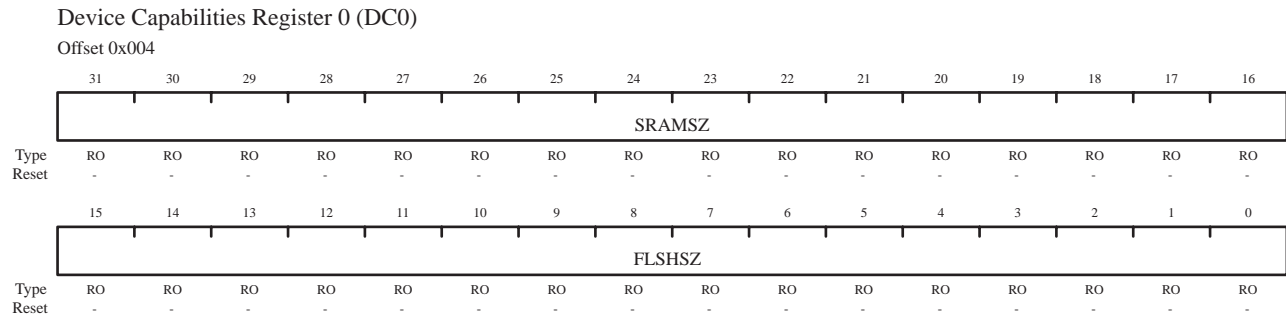
---

| Bit/Field | Name                             | Type | Reset     | Description   |      |             |    |                                  |    |                                |    |                 |    |          |
|-----------|----------------------------------|------|-----------|---|------|-------------|----|----------------------------------|----|--------------------------------|----|-----------------|----|----------|
| 2         | RoHS                             | RO   | 1         | RoHS-Compliance<br>A 1 in this bit specifies the device is RoHS-compliant.  |      |             |    |                                  |    |                                |    |                 |    |          |
| 1:0       | QUAL                             | RO   | see table | This field specifies the qualification status of the device.<br>This field is encoded as follows:<br><table><thead><tr><th>QUAL</th><th>Description</th></tr></thead><tbody><tr><td>00</td><td>Engineering Sample (unqualified)</td></tr><tr><td>01</td><td>Pilot Production (unqualified)</td></tr><tr><td>10</td><td>Fully Qualified</td></tr><tr><td>11</td><td>Reserved</td></tr></tbody></table> | QUAL | Description | 00 | Engineering Sample (unqualified) | 01 | Pilot Production (unqualified) | 10 | Fully Qualified | 11 | Reserved |
| QUAL      | Description                      |      |           |   |      |             |    |                                  |    |                                |    |                 |    |          |
| 00        | Engineering Sample (unqualified) |      |           |   |      |             |    |                                  |    |                                |    |                 |    |          |
| 01        | Pilot Production (unqualified)   |      |           |   |      |             |    |                                  |    |                                |    |                 |    |          |
| 10        | Fully Qualified                  |      |           |   |      |             |    |                                  |    |                                |    |                 |    |          |
| 11        | Reserved                         |      |           |   |      |             |    |                                  |    |                                |    |                 |    |          |

**Register 3: Device Capabilities 0 (DC0), offset 0x008**

This register is predefined by the part and can be used to verify features.

**Note:** The bit diagram indicates the values are device-specific. The table below indicates values for your specific part.



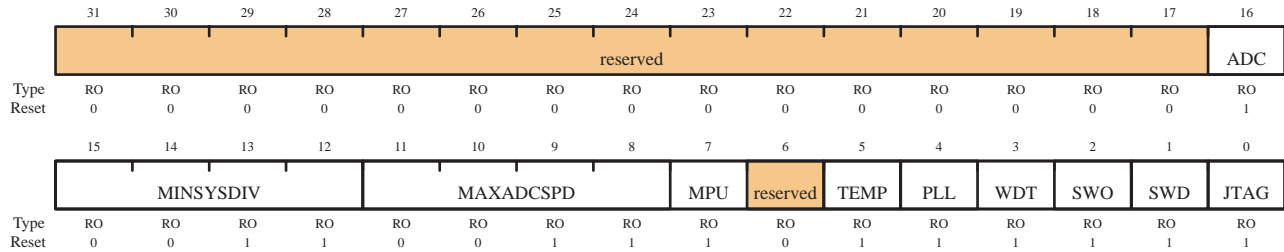
| Bit/Field | Name   | Type | Reset  | Description   |
|-----------|--------|------|--------|---|
| 31:16     | SRAMSZ | RO   | 0x001F | Indicates the size of the on-chip SRAM. A value of 0x001F indicates 8 KB of SRAM.           |
| 15:0      | FLSHSZ | RO   | 0x000F | Indicates the size of the on-chip flash memory. A value of 0x000F indicates 32 KB of Flash. |

**Register 4: Device Capabilities 1 (DC1), offset 0x010**

This register is predefined by the part and can be used to verify features.

Device Capabilities 1 (DC1)

Offset 0x010



| Bit/Field | Name                   | Type | Reset | Description   |
|-----------|------------------------|------|-------|---|
| 31:17     | reserved               | RO   | 0     | Reserved bits return an indeterminate value, and should never be changed.   |
| 16        | ADC <sup>a</sup>       | RO   | 1     | A 1 in this bit indicates the presence of the ADC module.   |
| 15:12     | MINSYSDIV              | RO   | 0x03  | The reset value is hardware-dependent. A value of 0x03 specifies a 50-MHz CPU clock with a PLL divider of 4. See the <b>RCC</b> register (page 75) for how to change the system clock divisor using the <i>SYSDIV</i> bit.  |
| 11:8      | MAXADCSPD <sup>a</sup> | RO   | 0x3   | This field indicates the maximum rate at which the ADC samples data. A value of 0x3 indicates 1M samples per second.  |
| 7         | MPU                    | RO   | 1     | This bit indicates whether the Memory Protection Unit (MPU) in the Cortex-M3 is available. A 0 in this bit indicates the MPU is not available; a 1 indicates the MPU is available.<br><br>See the <i>ARM® Cortex™-M3 Technical Reference Manual</i> for details on the MPU. |
| 6         | reserved               | RO   | 0     | Reserved bits return an indeterminate value, and should never be changed.   |
| 5         | TEMP                   | RO   | 1     | This bit specifies the presence of an internal temperature sensor.  |
| 4         | PLL                    | RO   | 1     | A 1 in this bit indicates the presence of an implemented PLL in the device.   |
| 3         | WDT <sup>a</sup>       | RO   | 1     | A 1 in this bit indicates a watchdog timer on the device.   |
| 2         | SWO <sup>a</sup>       | RO   | 1     | A 1 in this bit indicates the presence of the ARM Serial Wire Output (SWO) trace port capabilities.   |
| 1         | SWD <sup>a</sup>       | RO   | 1     | A 1 in this bit indicates the presence of the ARM Serial Wire Debug (SWD) capabilities.   |

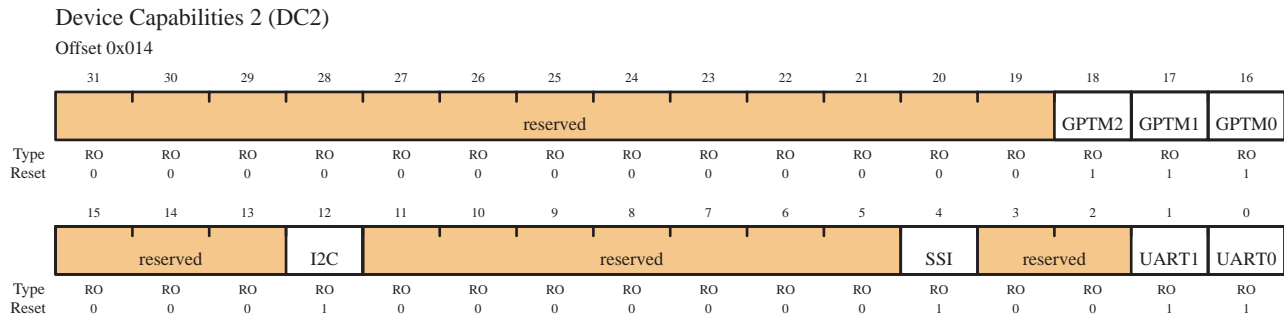
| Bit/Field | Name              | Type | Reset | Description  |
|-----------|-------------------|------|-------|--|
| 0         | JTAG <sup>a</sup> | RO   | 1     | A 1 in this bit indicates the presence of a JTAG port. |

- a. These bits mask the **Run-Mode Clock Gating Control 0 (RCGC0)** register (see page 113), **Sleep-Mode Clock Gating Control 0 (SCGC0)** register (see page 113), and **Deep-Sleep-Mode Clock Gating Control 0 (DCGC0)** register (see page 113). Bits that are not noted are passed as 0. ADCSP is clipped to the maximum value specified in DC1.

**Register 5: Device Capabilities 2 (DC2), offset 0x014**

**Note:** The bit diagram indicates all possible features. The table below indicates values for your specific part.

This register is predefined by the part and can be used to verify features.



| Bit/Field | Name     | Type | Reset | Description   |
|-----------|----------|------|-------|---|
| 31:19     | reserved | RO   | 0     | Reserved bits return an indeterminate value, and should never be changed. |
| 18        | GPTM2    | RO   | 1     | A 1 in this bit indicates the presence of General-Purpose Timer module 2. |
| 17        | GPTM1    | RO   | 1     | A 1 in this bit indicates the presence of General-Purpose Timer module 1. |
| 16        | GPTM0    | RO   | 1     | A 1 in this bit indicates the presence of General-Purpose Timer module 0. |
| 15:13     | reserved | RO   | 0     | Reserved bits return an indeterminate value, and should never be changed. |
| 12        | I2C      | RO   | 1     | A 1 in this bit indicates the presence of the I <sup>2</sup> C module.    |
| 11:5      | reserved | RO   | 0     | Reserved bits return an indeterminate value, and should never be changed. |
| 4         | SSI      | RO   | 1     | A 1 in this bit indicates the presence of the SSI module.                 |
| 3:2       | reserved | RO   | 0     | Reserved bits return an indeterminate value, and should never be changed. |
| 1         | UART1    | RO   | 1     | A 1 in this bit indicates the presence of the UART1 module.               |
| 0         | UART0    | RO   | 1     | A 1 in this bit indicates the presence of the UART0 module.               |

**Register 6: Device Capabilities 3 (DC3), offset 0x018**

**Note:** The bit diagram indicates all possible features. The table below indicates values for your specific part.

This register is predefined by the part and can be used to verify features.

## Device Capabilities 3 (DC3)

Offset 0x018

|       |          |    |    |    |      |      |      |      |      |      |      |      |      |      |      |      |
|-------|----------|----|----|----|------|------|------|------|------|------|------|------|------|------|------|------|
|       | 31       | 30 | 29 | 28 | 27   | 26   | 25   | 24   | 23   | 22   | 21   | 20   | 19   | 18   | 17   | 16   |
|       | reserved |    |    |    | CCP3 | CCP2 | CCP1 | CCP0 | ADC7 | ADC6 | ADC5 | ADC4 | ADC3 | ADC2 | ADC1 | ADC0 |
| Type  | RO       | RO | RO | RO | RO   | RO   | RO   | RO   | RO   | RO   | RO   | RO   | RO   | RO   | RO   | RO   |
| Reset | 0        | 0  | 0  | 0  | 1    | 1    | 1    | 1    | 1    | 1    | 1    | 1    | 1    | 1    | 1    | 1    |
|       | 15       | 14 | 13 | 12 | 11   | 10   | 9    | 8    | 7    | 6    | 5    | 4    | 3    | 2    | 1    | 0    |
|       | reserved |    |    |    |      |      |      |      |      |      |      |      |      |      |      |      |
| Type  | RO       | RO | RO | RO | RO   | RO   | RO   | RO   | RO   | RO   | RO   | RO   | RO   | RO   | RO   | RO   |
| Reset | 0        | 0  | 0  | 0  | 0    | 0    | 0    | 0    | 0    | 0    | 0    | 0    | 0    | 0    | 0    | 0    |

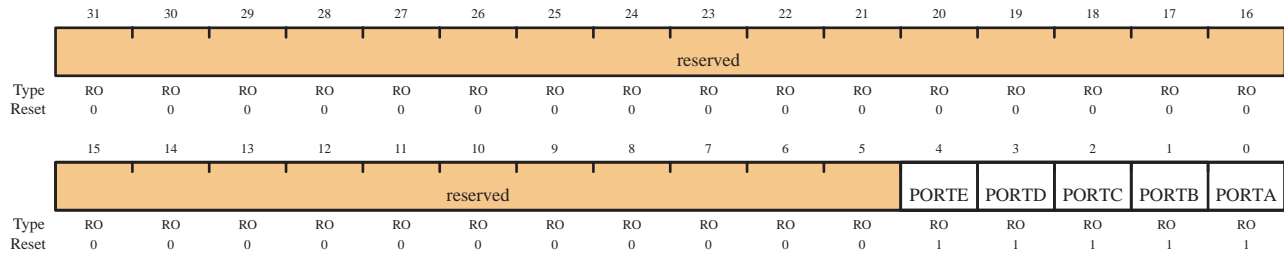
| Bit/Field | Name     | Type | Reset | Description   |
|-----------|----------|------|-------|---|
| 31:28     | reserved | RO   | 0     | Reserved bits return an indeterminate value, and should never be changed. |
| 27        | CCP3     | RO   | 1     | A 1 in this bit indicates the presence of the Capture/Compare/PWM pin 3.  |
| 26        | CCP2     | RO   | 1     | A 1 in this bit indicates the presence of the Capture/Compare/PWM pin 2.  |
| 25        | CCP1     | RO   | 1     | A 1 in this bit indicates the presence of the Capture/Compare/PWM pin 1.  |
| 24        | CCP0     | RO   | 1     | A 1 in this bit indicates the presence of the Capture/Compare/PWM pin 0.  |
| 23        | ADC7     | RO   | 1     | A 1 in this bit indicates the presence of the ADC7 pin.                   |
| 22        | ADC6     | RO   | 1     | A 1 in this bit indicates the presence of the ADC6 pin.                   |
| 21        | ADC5     | RO   | 1     | A 1 in this bit indicates the presence of the ADC5 pin.                   |
| 20        | ADC4     | RO   | 1     | A 1 in this bit indicates the presence of the ADC4 pin.                   |
| 19        | ADC3     | RO   | 1     | A 1 in this bit indicates the presence of the ADC3 pin.                   |
| 18        | ADC2     | RO   | 1     | A 1 in this bit indicates the presence of the ADC2 pin.                   |
| 17        | ADC1     | RO   | 1     | A 1 in this bit indicates the presence of the ADC1 pin.                   |
| 16        | ADC0     | RO   | 1     | A 1 in this bit indicates the presence of the ADC0 pin.                   |
| 15:0      | reserved | RO   | 0     | Reserved bits return an indeterminate value, and should never be changed. |

**Register 7: Device Capabilities 4 (DC4), offset 0x01C**

This register is predefined by the part and can be used to verify features.

Device Capabilities 4 (DC4)

Offset 0x01C



| Bit/Field | Name     | Type | Reset | Description   |
|-----------|----------|------|-------|---|
| 31:5      | reserved | RO   | 0     | Reserved bits return an indeterminate value, and should never be changed. |
| 4         | PORTE    | RO   | 1     | A 1 in this bit indicates the presence of GPIO Port E.                    |
| 3         | PORTD    | RO   | 1     | A 1 in this bit indicates the presence of GPIO Port D.                    |
| 2         | PORTC    | RO   | 1     | A 1 in this bit indicates the presence of GPIO Port C.                    |
| 1         | PORTB    | RO   | 1     | A 1 in this bit indicates the presence of GPIO Port B.                    |
| 0         | PORTA    | RO   | 1     | A 1 in this bit indicates the presence of GPIO Port A.                    |



**Register 8: Power-On and Brown-Out Reset Control (PBORCTL), offset 0x030**

This register is responsible for controlling reset conditions after initial power-on reset.

Power-On and Brown-Out Reset Control (PBORCTL)

Offset 0x030

|       |          |     |     |     |     |     |     |     |     |     |     |     |     |     |        |       |
|-------|----------|-----|-----|-----|-----|-----|-----|-----|-----|-----|-----|-----|-----|-----|--------|-------|
|       | 31       | 30  | 29  | 28  | 27  | 26  | 25  | 24  | 23  | 22  | 21  | 20  | 19  | 18  | 17     | 16    |
|       | reserved |     |     |     |     |     |     |     |     |     |     |     |     |     |        |       |
| Type  | RO       | RO  | RO  | RO  | RO  | RO  | RO  | RO  | RO  | RO  | RO  | RO  | RO  | RO  | RO     | RO    |
| Reset | 0        | 0   | 0   | 0   | 0   | 0   | 0   | 0   | 0   | 0   | 0   | 0   | 0   | 0   | 0      | 0     |
|       | 15       | 14  | 13  | 12  | 11  | 10  | 9   | 8   | 7   | 6   | 5   | 4   | 3   | 2   | 1      | 0     |
|       | BORTIM   |     |     |     |     |     |     |     |     |     |     |     |     |     | BORIOR | BORWT |
| Type  | R/W      | R/W | R/W | R/W | R/W | R/W | R/W | R/W | R/W | R/W | R/W | R/W | R/W | R/W | R/W    | R/W   |
| Reset | 0        | 1   | 1   | 1   | 1   | 1   | 1   | 1   | 1   | 1   | 1   | 1   | 1   | 1   | 0      | 1     |

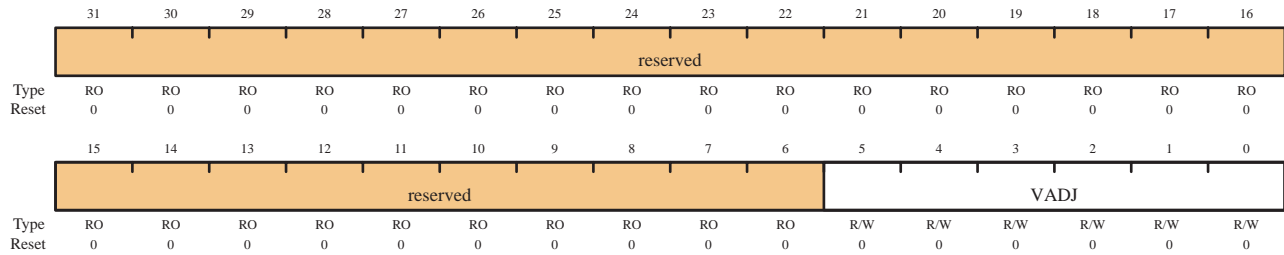
| Bit/Field | Name     | Type | Reset  | Description  |
|-----------|----------|------|--------|--|
| 31:16     | reserved | RO   | 0      | Reserved bits return an indeterminate value, and should never be changed.  |
| 15:2      | BORTIM   | R/W  | 0x1FFF | <p>This field specifies the number of internal oscillator clocks delayed before the BOR output is resampled if the BORWT bit is set.</p> <p>The width of this field is derived by the <math>t_{BOR}</math> width of 500 <math>\mu</math>s and the internal oscillator (IOSC) frequency of 15 MHz <math>\pm</math> 50%. At +50%, the counter value has to exceed 10,000.</p>  |
| 1         | BORIOR   | R/W  | 0      | <p>BOR Interrupt or Reset</p> <p>This bit controls how a BOR event is signaled to the controller. If set, a reset is signaled. Otherwise, an interrupt is signaled.</p>  |
| 0         | BORWT    | R/W  | 1      | <p>BOR Wait and Check for Noise</p> <p>This bit specifies the response to a brown-out signal assertion. If BORWT is set to 1, the controller waits BORTIM IOSC periods before resampling the BOR output, and if asserted, it signals a BOR condition interrupt or reset. If the BOR resample is deasserted, the cause of the initial assertion was likely noise and the interrupt or reset is suppressed. If BORWT is 0, BOR assertions do not resample the output and any condition is reported immediately if enabled.</p> |

**Register 9: LDO Power Control (LDOPCTL), offset 0x034**

The VADJ field in this register adjusts the on-chip output voltage (V<sub>OUT</sub>).

LDO Power Control (LDOPCTL)

Offset 0x034



| Bit/Field | Name     | Type | Reset | Description  |
|-----------|----------|------|-------|--|
| 31:6      | reserved | RO   | 0     | Reserved bits return an indeterminate value, and should never be changed.  |
| 5:0       | VADJ     | R/W  | 0x0   | This field sets the on-chip output voltage. The programming values for the VADJ field are provided in Table 6-2. |

**Table 6-2. VADJ to V<sub>OUT</sub>**

| VADJ Value | V <sub>OUT</sub> (V) | VADJ Value | V <sub>OUT</sub> (V) | VADJ Value | V <sub>OUT</sub> (V) |
|------------|----------------------|------------|----------------------|------------|----------------------|
| 0x1B       | 2.75                 | 0x1F       | 2.55                 | 0x03       | 2.35                 |
| 0x1C       | 2.70                 | 0x00       | 2.50                 | 0x04       | 2.30                 |
| 0x1D       | 2.65                 | 0x01       | 2.45                 | 0x05       | 2.25                 |
| 0x1E       | 2.60                 | 0x02       | 2.40                 | 0x06-0x3F  | Reserved             |

**Register 10: Software Reset Control 0 (SRCR0), offset 0x040**

Writes to this register are masked by the bits in the **Device Capabilities 1 (DC1)** register (see page 60).

## Software Reset Control 0 (SRCR0)

Offset 0x040

|       |          |    |    |    |    |    |    |    |    |    |    |    |     |          |    |     |     |
|-------|----------|----|----|----|----|----|----|----|----|----|----|----|-----|----------|----|-----|-----|
|       | 31       | 30 | 29 | 28 | 27 | 26 | 25 | 24 | 23 | 22 | 21 | 20 | 19  | 18       | 17 | 16  |     |
|       | reserved |    |    |    |    |    |    |    |    |    |    |    |     |          |    | ADC |     |
| Type  | RO       | RO | RO | RO | RO | RO | RO | RO | RO | RO | RO | RO | RO  | RO       | RO | RO  | R/W |
| Reset | 0        | 0  | 0  | 0  | 0  | 0  | 0  | 0  | 0  | 0  | 0  | 0  | 0   | 0        | 0  | 0   | 0   |
|       | 15       | 14 | 13 | 12 | 11 | 10 | 9  | 8  | 7  | 6  | 5  | 4  | 3   | 2        | 1  | 0   |     |
|       | reserved |    |    |    |    |    |    |    |    |    |    |    | WDT | reserved |    |     |     |
| Type  | RO       | RO | RO | RO | RO | RO | RO | RO | RO | RO | RO | RO | R/W | RO       | RO | RO  |     |
| Reset | 0        | 0  | 0  | 0  | 0  | 0  | 0  | 0  | 0  | 0  | 0  | 0  | 0   | 0        | 0  | 0   |     |

| Bit/Field | Name     | Type | Reset | Description   |
|-----------|----------|------|-------|---|
| 31:17     | reserved | RO   | 0     | Reserved bits return an indeterminate value, and should never be changed. |
| 16        | ADC      | R/W  | 0     | Reset control for the ADC units.  |
| 15:4      | reserved | RO   | 0     | Reserved bits return an indeterminate value, and should never be changed. |
| 3         | WDT      | R/W  | 0     | Reset control for the Watchdog unit.                                      |
| 2:0       | reserved | RO   | 0     | Reserved bits return an indeterminate value, and should never be changed. |

**Register 11: Software Reset Control 1 (SRCR1), offset 0x044**

Writes to this register are masked by the bits in the **Device Capabilities 2 (DC2)** register (see page 62).

Software Reset Control 1 (SRCR1)

Offset 0x044

|       |          |    |    |     |          |    |    |    |    |    |    |     |          |       |       |       |
|-------|----------|----|----|-----|----------|----|----|----|----|----|----|-----|----------|-------|-------|-------|
|       | 31       | 30 | 29 | 28  | 27       | 26 | 25 | 24 | 23 | 22 | 21 | 20  | 19       | 18    | 17    | 16    |
|       | reserved |    |    |     |          |    |    |    |    |    |    |     |          | GPTM2 | GPTM1 | GPTM0 |
| Type  | RO       | RO | RO | RO  | RO       | RO | RO | RO | RO | RO | RO | RO  | RO       | R/W   | R/W   | R/W   |
| Reset | 0        | 0  | 0  | 0   | 0        | 0  | 0  | 0  | 0  | 0  | 0  | 0   | 0        | 0     | 0     | 0     |
|       | 15       | 14 | 13 | 12  | 11       | 10 | 9  | 8  | 7  | 6  | 5  | 4   | 3        | 2     | 1     | 0     |
|       | reserved |    |    | I2C | reserved |    |    |    |    |    |    | SSI | reserved |       | UART1 | UART0 |
| Type  | RO       | RO | RO | R/W | RO       | RO | RO | RO | RO | RO | RO | R/W | RO       | RO    | R/W   | R/W   |
| Reset | 0        | 0  | 0  | 0   | 0        | 0  | 0  | 0  | 0  | 0  | 0  | 0   | 0        | 0     | 0     | 0     |

| Bit/Field | Name     | Type | Reset | Description   |
|-----------|----------|------|-------|---|
| 31:19     | reserved | RO   | 0     | Reserved bits return an indeterminate value, and should never be changed. |
| 18        | GPTM2    | R/W  | 0     | Reset control for General-Purpose Timer module 2.                         |
| 17        | GPTM1    | R/W  | 0     | Reset control for General-Purpose Timer module 1.                         |
| 16        | GPTM0    | R/W  | 0     | Reset control for General-Purpose Timer module 0.                         |
| 15:13     | reserved | RO   | 0     | Reserved bits return an indeterminate value, and should never be changed. |
| 12        | I2C      | R/W  | 0     | Reset control for the I <sup>2</sup> C units.                             |
| 11:5      | reserved | RO   | 0     | Reserved bits return an indeterminate value, and should never be changed. |
| 4         | SSI      | R/W  | 0     | Reset control for the SSI units.  |
| 3:2       | reserved | RO   | 0     | Reserved bits return an indeterminate value, and should never be changed. |
| 1         | UART1    | R/W  | 0     | Reset control for the UART1 module.                                       |
| 0         | UART0    | R/W  | 0     | Reset control for the UART0 module.                                       |

**Register 12: Software Reset Control 2 (SRCR2), offset 0x048**

Writes to this register are masked by the bits in the **Device Capabilities 4 (DC4)** register (see page 64).

## Software Reset Control (SRCR2)

Offset 0x048

|       |          |    |    |    |    |    |    |    |    |    |    |       |       |       |       |       |
|-------|----------|----|----|----|----|----|----|----|----|----|----|-------|-------|-------|-------|-------|
|       | 31       | 30 | 29 | 28 | 27 | 26 | 25 | 24 | 23 | 22 | 21 | 20    | 19    | 18    | 17    | 16    |
|       | reserved |    |    |    |    |    |    |    |    |    |    |       |       |       |       |       |
| Type  | RO       | RO | RO | RO | RO | RO | RO | RO | RO | RO | RO | RO    | RO    | RO    | RO    | RO    |
| Reset | 0        | 0  | 0  | 0  | 0  | 0  | 0  | 0  | 0  | 0  | 0  | 0     | 0     | 0     | 0     | 0     |
|       | 15       | 14 | 13 | 12 | 11 | 10 | 9  | 8  | 7  | 6  | 5  | 4     | 3     | 2     | 1     | 0     |
|       | reserved |    |    |    |    |    |    |    |    |    |    | PORTE | PORTD | PORTC | PORTB | PORTA |
| Type  | RO       | RO | RO | RO | RO | RO | RO | RO | RO | RO | RO | R/W   | R/W   | R/W   | R/W   | R/W   |
| Reset | 0        | 0  | 0  | 0  | 0  | 0  | 0  | 0  | 0  | 0  | 0  | 0     | 0     | 0     | 0     | 0     |

| Bit/Field | Name     | Type | Reset | Description   |
|-----------|----------|------|-------|---|
| 31:5      | reserved | RO   | 0     | Reserved bits return an indeterminate value, and should never be changed. |
| 4         | PORTE    | R/W  | 0     | Reset control for GPIO Port E.  |
| 3         | PORTD    | R/W  | 0     | Reset control for GPIO Port D.  |
| 2         | PORTC    | R/W  | 0     | Reset control for GPIO Port C.  |
| 1         | PORTB    | R/W  | 0     | Reset control for GPIO Port B.  |
| 0         | PORTA    | R/W  | 0     | Reset control for GPIO Port A.  |

**Register 13: Raw Interrupt Status (RIS), offset 0x050**

Central location for system control raw interrupts. These are set and cleared by hardware.

Raw Interrupt Status (RIS)

Offset 0x050

|       |          |    |    |    |    |    |    |    |    |    |         |       |        |        |        |        |         |
|-------|----------|----|----|----|----|----|----|----|----|----|---------|-------|--------|--------|--------|--------|---------|
|       | 31       | 30 | 29 | 28 | 27 | 26 | 25 | 24 | 23 | 22 | 21      | 20    | 19     | 18     | 17     | 16     |         |
|       | reserved |    |    |    |    |    |    |    |    |    |         |       |        |        |        |        |         |
| Type  | RO       | RO | RO | RO | RO | RO | RO | RO | RO | RO | RO      | RO    | RO     | RO     | RO     | RO     |         |
| Reset | 0        | 0  | 0  | 0  | 0  | 0  | 0  | 0  | 0  | 0  | 0       | 0     | 0      | 0      | 0      | 0      |         |
|       | 15       | 14 | 13 | 12 | 11 | 10 | 9  | 8  | 7  | 6  | 5       | 4     | 3      | 2      | 1      | 0      |         |
|       | reserved |    |    |    |    |    |    |    |    |    | PLLLRIS | CLRIS | IOFRIS | MOFRIS | LDORIS | BORRIS | PLLFRIS |
| Type  | RO       | RO | RO | RO | RO | RO | RO | RO | RO | RO | RO      | RO    | RO     | RO     | RO     | RO     |         |
| Reset | 0        | 0  | 0  | 0  | 0  | 0  | 0  | 0  | 0  | 0  | 0       | 0     | 0      | 0      | 0      | 0      |         |

| Bit/Field | Name     | Type | Reset | Description  |
|-----------|----------|------|-------|--|
| 31:7      | reserved | RO   | 0     | Reserved bits return an indeterminate value, and should never be changed.  |
| 6         | PLLLRIS  | RO   | 0     | PLL Lock Raw Interrupt Status<br>This bit is set when the PLL T <sub>READY</sub> Timer asserts.  |
| 5         | CLRIS    | RO   | 0     | Current Limit Raw Interrupt Status<br>This bit is set if the LDO's CLE output asserts.   |
| 4         | IOFRIS   | RO   | 0     | Internal Oscillator Fault Raw Interrupt Status<br>This bit is set if an internal oscillator fault is detected.   |
| 3         | MOFRIS   | RO   | 0     | Main Oscillator Fault Raw Interrupt Status<br>This bit is set if a main oscillator fault is detected.  |
| 2         | LDORIS   | RO   | 0     | LDO Power Unregulated Raw Interrupt Status<br>This bit is set if a LDO voltage is unregulated.   |
| 1         | BORRIS   | RO   | 0     | Brown-Out Reset Raw Interrupt Status<br>This bit is the raw interrupt status for any brown-out conditions. If set, a brown-out condition was detected. An interrupt is reported if the BORIM bit in the <b>IMC</b> register is set and the BORIOR bit in the <b>PBORCTL</b> register is cleared. |
| 0         | PLLFRIS  | RO   | 0     | PLL Fault Raw Interrupt Status<br>This bit is set if a PLL fault is detected (stops oscillating).  |

**Register 14: Interrupt Mask Control (IMC), offset 0x054**

Central location for system control interrupt masks.

## Interrupt Mask Control (IMC)

Offset 0x054

|       |          |    |    |    |    |    |    |    |    |    |        |      |       |       |       |       |        |
|-------|----------|----|----|----|----|----|----|----|----|----|--------|------|-------|-------|-------|-------|--------|
|       | 31       | 30 | 29 | 28 | 27 | 26 | 25 | 24 | 23 | 22 | 21     | 20   | 19    | 18    | 17    | 16    |        |
|       | reserved |    |    |    |    |    |    |    |    |    |        |      |       |       |       |       |        |
| Type  | RO       | RO | RO | RO | RO | RO | RO | RO | RO | RO | RO     | RO   | RO    | RO    | RO    | RO    |        |
| Reset | 0        | 0  | 0  | 0  | 0  | 0  | 0  | 0  | 0  | 0  | 0      | 0    | 0     | 0     | 0     | 0     |        |
|       | 15       | 14 | 13 | 12 | 11 | 10 | 9  | 8  | 7  | 6  | 5      | 4    | 3     | 2     | 1     | 0     |        |
|       | reserved |    |    |    |    |    |    |    |    |    | PLLLIM | CLIM | IOFIM | MOFIM | LDOIM | BORIM | PLLFIM |
| Type  | RO       | RO | RO | RO | RO | RO | RO | RO | RO | RO | R/W    | R/W  | R/W   | R/W   | R/W   | R/W   |        |
| Reset | 0        | 0  | 0  | 0  | 0  | 0  | 0  | 0  | 0  | 0  | 0      | 0    | 0     | 0     | 0     | 0     |        |

| Bit/Field | Name     | Type | Reset | Description  |
|-----------|----------|------|-------|--|
| 31:7      | reserved | RO   | 0     | Reserved bits return an indeterminate value, and should never be changed.  |
| 6         | PLLLIM   | R/W  | 0     | PLL Lock Interrupt Mask<br><br>This bit specifies whether a current limit detection is promoted to a controller interrupt. If set, an interrupt is generated if PLLLRIS in <b>RIS</b> is set; otherwise, an interrupt is not generated.                |
| 5         | CLIM     | R/W  | 0     | Current Limit Interrupt Mask<br><br>This bit specifies whether a current limit detection is promoted to a controller interrupt. If set, an interrupt is generated if CLRIS is set; otherwise, an interrupt is not generated.                           |
| 4         | IOFIM    | R/W  | 0     | Internal Oscillator Fault Interrupt Mask<br><br>This bit specifies whether an internal oscillator fault detection is promoted to a controller interrupt. If set, an interrupt is generated if IOFRIS is set; otherwise, an interrupt is not generated. |
| 3         | MOFIM    | R/W  | 0     | Main Oscillator Fault Interrupt Mask<br><br>This bit specifies whether a main oscillator fault detection is promoted to a controller interrupt. If set, an interrupt is generated if MOFRIS is set; otherwise, an interrupt is not generated.          |
| 2         | LDOIM    | R/W  | 0     | LDO Power Unregulated Interrupt Mask<br><br>This bit specifies whether an LDO unregulated power situation is promoted to a controller interrupt. If set, an interrupt is generated if LDORIS is set; otherwise, an interrupt is not generated.         |

| Bit/Field | Name   | Type | Reset | Description  |
|-----------|--------|------|-------|--|
| 1         | BORIM  | R/W  | 0     | <b>Brown-Out Reset Interrupt Mask</b><br><br>This bit specifies whether a brown-out condition is promoted to a controller interrupt. If set, an interrupt is generated if BORRIS is set; otherwise, an interrupt is not generated. |
| 0         | PLLFIM | R/W  | 0     | <b>PLL Fault Interrupt Mask</b><br><br>This bit specifies whether a PLL fault detection is promoted to a controller interrupt. If set, an interrupt is generated if PLLFRIS is set; otherwise, an interrupt is not generated.      |



**Register 15: Masked Interrupt Status and Clear (MISC), offset 0x058**

Central location for system control result of RIS AND IMC to generate an interrupt to the controller. All of the bits are R/W1C and this action also clears the corresponding raw interrupt bit in the **RIS** register (see page 70).

## Masked Interrupt Status and Clear (MISC)

Offset 0x058

|       |          |    |    |    |    |    |    |    |    |       |         |       |        |        |        |        |         |
|-------|----------|----|----|----|----|----|----|----|----|-------|---------|-------|--------|--------|--------|--------|---------|
|       | 31       | 30 | 29 | 28 | 27 | 26 | 25 | 24 | 23 | 22    | 21      | 20    | 19     | 18     | 17     | 16     |         |
|       | reserved |    |    |    |    |    |    |    |    |       |         |       |        |        |        |        |         |
| Type  | RO       | RO | RO | RO | RO | RO | RO | RO | RO | RO    | RO      | RO    | RO     | RO     | RO     | RO     |         |
| Reset | 0        | 0  | 0  | 0  | 0  | 0  | 0  | 0  | 0  | 0     | 0       | 0     | 0      | 0      | 0      | 0      |         |
|       | 15       | 14 | 13 | 12 | 11 | 10 | 9  | 8  | 7  | 6     | 5       | 4     | 3      | 2      | 1      | 0      |         |
|       | reserved |    |    |    |    |    |    |    |    |       | PLLLMIS | CLMIS | IOFMIS | MOFMIS | LDOMIS | BORMIS | PLLFMIS |
| Type  | RO       | RO | RO | RO | RO | RO | RO | RO | RO | R/W1C | R/W1C   | R/W1C | R/W1C  | R/W1C  | R/W1C  | R/W1C  |         |
| Reset | 0        | 0  | 0  | 0  | 0  | 0  | 0  | 0  | 0  | 0     | 0       | 0     | 0      | 0      | 0      | 0      |         |

| Bit/Field | Name     | Type  | Reset | Description   |
|-----------|----------|-------|-------|---|
| 31:7      | reserved | RO    | 0     | Reserved bits return an indeterminate value, and should never be changed.   |
| 6         | PLLLMIS  | R/W1C | 0     | PLL Lock Masked Interrupt Status<br>This bit is set when the PLL T <sub>READY</sub> timer asserts. The interrupt is cleared by writing a 1 to this bit.   |
| 5         | CLMIS    | R/W1C | 0     | Current Limit Masked Interrupt Status<br>This bit is set if the LDO's CLE output asserts. The interrupt is cleared by writing a 1 to this bit.  |
| 4         | IOFMIS   | R/W1C | 0     | Internal Oscillator Fault Masked Interrupt Status<br>This bit is set if an internal oscillator fault is detected. The interrupt is cleared by writing a 1 to this bit.  |
| 3         | MOFMIS   | R/W1C | 0     | Main Oscillator Fault Masked Interrupt Status<br>This bit is set if a main oscillator fault is detected. The interrupt is cleared by writing a 1 to this bit.   |
| 2         | LDOMIS   | R/W1C | 0     | LDO Power Unregulated Masked Interrupt Status<br>This bit is set if LDO power is unregulated. The interrupt is cleared by writing a 1 to this bit.  |
| 1         | BORMIS   | R/W1C | 0     | Brown-Out Reset Masked Interrupt Status<br>This bit is the masked interrupt status for any brown-out conditions. If set, a brown-out condition was detected. An interrupt is reported if the BORIM bit in the <b>IMC</b> register is set and the BORIOR bit in the <b>PBORCTL</b> register is cleared. The interrupt is cleared by writing a 1 to this bit. |
| 0         | PLLFMIS  | R/W1C | 0     | PLL Fault Masked Interrupt Status<br>This bit is set if a PLL fault is detected (stops oscillating). The interrupt is cleared by writing a 1 to this bit.   |

**Register 16: Reset Cause (RESC), offset 0x05C**

This field specifies the cause of the reset event to software. The reset value is determined by the cause of the reset. When an external reset is the cause ( $\overline{\text{EXT}}$  is set), all other reset bits are cleared. However, if the reset is due to any other cause, the remaining bits are sticky, allowing software to see all causes.

Reset Cause (RESC)

Offset 0x05C

|       |          |    |    |    |    |    |    |    |    |    |     |     |     |     |     |     |
|-------|----------|----|----|----|----|----|----|----|----|----|-----|-----|-----|-----|-----|-----|
|       | 31       | 30 | 29 | 28 | 27 | 26 | 25 | 24 | 23 | 22 | 21  | 20  | 19  | 18  | 17  | 16  |
|       | reserved |    |    |    |    |    |    |    |    |    |     |     |     |     |     |     |
| Type  | RO       | RO | RO | RO | RO | RO | RO | RO | RO | RO | RO  | RO  | RO  | RO  | RO  | RO  |
| Reset | 0        | 0  | 0  | 0  | 0  | 0  | 0  | 0  | 0  | 0  | 0   | 0   | 0   | 0   | 0   | 0   |
|       | 15       | 14 | 13 | 12 | 11 | 10 | 9  | 8  | 7  | 6  | 5   | 4   | 3   | 2   | 1   | 0   |
|       | reserved |    |    |    |    |    |    |    |    |    | LDO | SW  | WDT | BOR | POR | EXT |
| Type  | RO       | RO | RO | RO | RO | RO | RO | RO | RO | RO | R/W | R/W | R/W | R/W | R/W | R/W |
| Reset | 0        | 0  | 0  | 0  | 0  | 0  | 0  | 0  | 0  | 0  | -   | -   | -   | -   | -   | -   |

| Bit/Field | Name     | Type | Reset | Description  |
|-----------|----------|------|-------|--|
| 31:6      | reserved | RO   | 0     | Reserved bits return an indeterminate value, and should never be changed.                              |
| 5         | LDO      | R/W  | -     | When set to 1, LDO power OK lost is the cause of the reset event.                                      |
| 4         | SW       | R/W  | -     | When set to 1, a software reset is the cause of the reset event.                                       |
| 3         | WDT      | R/W  | -     | When set to 1, a watchdog reset is the cause of the reset event.                                       |
| 2         | BOR      | R/W  | -     | When set to 1, a brown-out reset is the cause of the reset event.                                      |
| 1         | POR      | R/W  | -     | When set to 1, a power-on reset is the cause of the reset event.                                       |
| 0         | EXT      | R/W  | -     | When set to 1, an external reset ( $\overline{\text{RST}}$ assertion) is the cause of the reset event. |

**Register 17: Run-Mode Clock Configuration (RCC), offset 0x060**

This register is defined to provide source control and frequency speed.

## Run-Mode Clock Configuration (RCC)

Offset 0x060

|       |          |    |       |     |        |        |      |     |     |     |            |          |          |          |         |         |
|-------|----------|----|-------|-----|--------|--------|------|-----|-----|-----|------------|----------|----------|----------|---------|---------|
|       | 31       | 30 | 29    | 28  | 27     | 26     | 25   | 24  | 23  | 22  | 21         | 20       | 19       | 18       | 17      | 16      |
|       | reserved |    |       |     | ACG    | SYSDIV |      |     |     |     | USESYS DIV | reserved |          |          |         |         |
| Type  | RO       | RO | RO    | RO  | R/W    | R/W    | R/W  | R/W | R/W | R/W | RO         | RO       | RO       | RO       | RO      | RO      |
| Reset | 0        | 0  | 0     | 0   | 0      | 1      | 1    | 1   | 1   | 0   | 0          | 0        | 0        | 0        | 0       | 0       |
|       | 15       | 14 | 13    | 12  | 11     | 10     | 9    | 8   | 7   | 6   | 5          | 4        | 3        | 2        | 1       | 0       |
|       | reserved |    | PWRDN | OEN | BYPASS | PLLVER | XTAL |     |     |     | OSCSRC     |          | IOSCV ER | MOSCV ER | IOSCDIS | MOSCDIS |
| Type  | RO       | RO | R/W   | R/W | R/W    | R/W    | R/W  | R/W | R/W | R/W | R/W        | R/W      | R/W      | R/W      | R/W     | R/W     |
| Reset | 0        | 0  | 1     | 1   | 1      | 0      | 1    | 0   | 1   | 1   | 0          | 0        | 0        | 0        | 0       | 0       |

| Bit/Field | Name     | Type | Reset | Description   |
|-----------|----------|------|-------|---|
| 31:28     | Reserved | RO   | 0     | Reserved bits return an indeterminate value, and should never be changed.   |
| 27        | ACG      | R/W  | 0     | <p>Auto Clock Gating</p> <p>This bit specifies whether the system uses the <b>Sleep-Mode Clock Gating Control (SCGCn)</b> registers (see page 80) and <b>Deep-Sleep-Mode Clock Gating Control (DCGCn)</b> registers (see page 80) if the controller enters a Sleep or Deep-Sleep mode (respectively). If set, the <b>SCGCn</b> or <b>DCGCn</b> registers are used to control the clocks distributed to the peripherals when the controller is in a sleep mode. Otherwise, the <b>Run-Mode Clock Gating Control (RCGCn)</b> registers (see page 80) are used when the controller enters a sleep mode.</p> <p>The <b>RCGCn</b> registers are always used to control the clocks in Run mode.</p> <p>This allows peripherals to consume less power when the controller is in a sleep mode and the peripheral is unused.</p> |

| Bit/Field    | Name               | Type                 | Reset | Description  |              |                    |                      |      |          |          |      |    |          |      |    |          |      |    |        |      |    |        |      |    |           |      |    |           |      |    |        |      |    |           |      |     |        |      |     |           |      |     |           |      |     |           |      |     |           |      |     |           |      |     |                    |
|--------------|--------------------|----------------------|-------|--|--------------|--------------------|----------------------|------|----------|----------|------|----|----------|------|----|----------|------|----|--------|------|----|--------|------|----|-----------|------|----|-----------|------|----|--------|------|----|-----------|------|-----|--------|------|-----|-----------|------|-----|-----------|------|-----|-----------|------|-----|-----------|------|-----|-----------|------|-----|--------------------|
| 26:23        | SYSDIV             | R/W                  | 0xF   | <p>System Clock Divisor</p> <p>Specifies which divisor is used to generate the system clock from the PLL output (200 MHz).</p> <table border="1"> <thead> <tr> <th>Binary Value</th> <th>Divisor (BYPASS=1)</th> <th>Frequency (BYPASS=0)</th> </tr> </thead> <tbody> <tr><td>0000</td><td>reserved</td><td>reserved</td></tr> <tr><td>0001</td><td>/2</td><td>reserved</td></tr> <tr><td>0010</td><td>/3</td><td>reserved</td></tr> <tr><td>0011</td><td>/4</td><td>50 MHz</td></tr> <tr><td>0100</td><td>/5</td><td>40 MHz</td></tr> <tr><td>0101</td><td>/6</td><td>33.33 MHz</td></tr> <tr><td>0110</td><td>/7</td><td>28.57 MHz</td></tr> <tr><td>0111</td><td>/8</td><td>25 MHz</td></tr> <tr><td>1000</td><td>/9</td><td>22.22 MHz</td></tr> <tr><td>1001</td><td>/10</td><td>20 MHz</td></tr> <tr><td>1010</td><td>/11</td><td>18.18 MHz</td></tr> <tr><td>1011</td><td>/12</td><td>16.67 MHz</td></tr> <tr><td>1100</td><td>/13</td><td>15.38 MHz</td></tr> <tr><td>1101</td><td>/14</td><td>14.29 MHz</td></tr> <tr><td>1110</td><td>/15</td><td>13.33 MHz</td></tr> <tr><td>1111</td><td>/16</td><td>12.5 MHz (default)</td></tr> </tbody> </table> <p>When reading the <b>Run-Mode Clock Configuration (RCC)</b> register (see page 75), the <b>SYSDIV</b> value is <b>MINSYSDIV</b> if a lower divisor was requested and the PLL is being used. This lower value is allowed to divide a non-PLL source.</p> | Binary Value | Divisor (BYPASS=1) | Frequency (BYPASS=0) | 0000 | reserved | reserved | 0001 | /2 | reserved | 0010 | /3 | reserved | 0011 | /4 | 50 MHz | 0100 | /5 | 40 MHz | 0101 | /6 | 33.33 MHz | 0110 | /7 | 28.57 MHz | 0111 | /8 | 25 MHz | 1000 | /9 | 22.22 MHz | 1001 | /10 | 20 MHz | 1010 | /11 | 18.18 MHz | 1011 | /12 | 16.67 MHz | 1100 | /13 | 15.38 MHz | 1101 | /14 | 14.29 MHz | 1110 | /15 | 13.33 MHz | 1111 | /16 | 12.5 MHz (default) |
| Binary Value | Divisor (BYPASS=1) | Frequency (BYPASS=0) |       |  |              |                    |                      |      |          |          |      |    |          |      |    |          |      |    |        |      |    |        |      |    |           |      |    |           |      |    |        |      |    |           |      |     |        |      |     |           |      |     |           |      |     |           |      |     |           |      |     |           |      |     |                    |
| 0000         | reserved           | reserved             |       |  |              |                    |                      |      |          |          |      |    |          |      |    |          |      |    |        |      |    |        |      |    |           |      |    |           |      |    |        |      |    |           |      |     |        |      |     |           |      |     |           |      |     |           |      |     |           |      |     |           |      |     |                    |
| 0001         | /2                 | reserved             |       |  |              |                    |                      |      |          |          |      |    |          |      |    |          |      |    |        |      |    |        |      |    |           |      |    |           |      |    |        |      |    |           |      |     |        |      |     |           |      |     |           |      |     |           |      |     |           |      |     |           |      |     |                    |
| 0010         | /3                 | reserved             |       |  |              |                    |                      |      |          |          |      |    |          |      |    |          |      |    |        |      |    |        |      |    |           |      |    |           |      |    |        |      |    |           |      |     |        |      |     |           |      |     |           |      |     |           |      |     |           |      |     |           |      |     |                    |
| 0011         | /4                 | 50 MHz               |       |  |              |                    |                      |      |          |          |      |    |          |      |    |          |      |    |        |      |    |        |      |    |           |      |    |           |      |    |        |      |    |           |      |     |        |      |     |           |      |     |           |      |     |           |      |     |           |      |     |           |      |     |                    |
| 0100         | /5                 | 40 MHz               |       |  |              |                    |                      |      |          |          |      |    |          |      |    |          |      |    |        |      |    |        |      |    |           |      |    |           |      |    |        |      |    |           |      |     |        |      |     |           |      |     |           |      |     |           |      |     |           |      |     |           |      |     |                    |
| 0101         | /6                 | 33.33 MHz            |       |  |              |                    |                      |      |          |          |      |    |          |      |    |          |      |    |        |      |    |        |      |    |           |      |    |           |      |    |        |      |    |           |      |     |        |      |     |           |      |     |           |      |     |           |      |     |           |      |     |           |      |     |                    |
| 0110         | /7                 | 28.57 MHz            |       |  |              |                    |                      |      |          |          |      |    |          |      |    |          |      |    |        |      |    |        |      |    |           |      |    |           |      |    |        |      |    |           |      |     |        |      |     |           |      |     |           |      |     |           |      |     |           |      |     |           |      |     |                    |
| 0111         | /8                 | 25 MHz               |       |  |              |                    |                      |      |          |          |      |    |          |      |    |          |      |    |        |      |    |        |      |    |           |      |    |           |      |    |        |      |    |           |      |     |        |      |     |           |      |     |           |      |     |           |      |     |           |      |     |           |      |     |                    |
| 1000         | /9                 | 22.22 MHz            |       |  |              |                    |                      |      |          |          |      |    |          |      |    |          |      |    |        |      |    |        |      |    |           |      |    |           |      |    |        |      |    |           |      |     |        |      |     |           |      |     |           |      |     |           |      |     |           |      |     |           |      |     |                    |
| 1001         | /10                | 20 MHz               |       |  |              |                    |                      |      |          |          |      |    |          |      |    |          |      |    |        |      |    |        |      |    |           |      |    |           |      |    |        |      |    |           |      |     |        |      |     |           |      |     |           |      |     |           |      |     |           |      |     |           |      |     |                    |
| 1010         | /11                | 18.18 MHz            |       |  |              |                    |                      |      |          |          |      |    |          |      |    |          |      |    |        |      |    |        |      |    |           |      |    |           |      |    |        |      |    |           |      |     |        |      |     |           |      |     |           |      |     |           |      |     |           |      |     |           |      |     |                    |
| 1011         | /12                | 16.67 MHz            |       |  |              |                    |                      |      |          |          |      |    |          |      |    |          |      |    |        |      |    |        |      |    |           |      |    |           |      |    |        |      |    |           |      |     |        |      |     |           |      |     |           |      |     |           |      |     |           |      |     |           |      |     |                    |
| 1100         | /13                | 15.38 MHz            |       |  |              |                    |                      |      |          |          |      |    |          |      |    |          |      |    |        |      |    |        |      |    |           |      |    |           |      |    |        |      |    |           |      |     |        |      |     |           |      |     |           |      |     |           |      |     |           |      |     |           |      |     |                    |
| 1101         | /14                | 14.29 MHz            |       |  |              |                    |                      |      |          |          |      |    |          |      |    |          |      |    |        |      |    |        |      |    |           |      |    |           |      |    |        |      |    |           |      |     |        |      |     |           |      |     |           |      |     |           |      |     |           |      |     |           |      |     |                    |
| 1110         | /15                | 13.33 MHz            |       |  |              |                    |                      |      |          |          |      |    |          |      |    |          |      |    |        |      |    |        |      |    |           |      |    |           |      |    |        |      |    |           |      |     |        |      |     |           |      |     |           |      |     |           |      |     |           |      |     |           |      |     |                    |
| 1111         | /16                | 12.5 MHz (default)   |       |  |              |                    |                      |      |          |          |      |    |          |      |    |          |      |    |        |      |    |        |      |    |           |      |    |           |      |    |        |      |    |           |      |     |        |      |     |           |      |     |           |      |     |           |      |     |           |      |     |           |      |     |                    |
| 22           | USESYSDIV          | R/W                  | 0     | Use the system clock divider as the source for the system clock. The system clock divider is forced to be used when the PLL is selected as the source.   |              |                    |                      |      |          |          |      |    |          |      |    |          |      |    |        |      |    |        |      |    |           |      |    |           |      |    |        |      |    |           |      |     |        |      |     |           |      |     |           |      |     |           |      |     |           |      |     |           |      |     |                    |
| 21:14        | reserved           | RO                   | 0     | Reserved bits return an indeterminate value, and should never be changed.  |              |                    |                      |      |          |          |      |    |          |      |    |          |      |    |        |      |    |        |      |    |           |      |    |           |      |    |        |      |    |           |      |     |        |      |     |           |      |     |           |      |     |           |      |     |           |      |     |           |      |     |                    |
| 13           | PWRDN              | R/W                  | 1     | <p>PLL Power Down</p> <p>This bit connects to the PLL PWRDN input. The reset value of 1 powers down the PLL. See Table 6-4 on page 78 for PLL mode control.</p>  |              |                    |                      |      |          |          |      |    |          |      |    |          |      |    |        |      |    |        |      |    |           |      |    |           |      |    |        |      |    |           |      |     |        |      |     |           |      |     |           |      |     |           |      |     |           |      |     |           |      |     |                    |
| 12           | OEN                | R/W                  | 1     | <p>PLL Output Enable</p> <p>This bit specifies whether the PLL output driver is enabled. If cleared, the driver transmits the PLL clock to the output. Otherwise, the PLL clock does not oscillate outside the PLL module.</p> <p><b>Note:</b> Both PWRDN and OEN must be cleared to run the PLL.</p>  |              |                    |                      |      |          |          |      |    |          |      |    |          |      |    |        |      |    |        |      |    |           |      |    |           |      |    |        |      |    |           |      |     |        |      |     |           |      |     |           |      |     |           |      |     |           |      |     |           |      |     |                    |

| Bit/Field               | Name  | Type | Reset | Description  |       |              |    |                           |    |                     |    |   |    |          |
|-------------------------|---|------|-------|--|-------|--------------|----|---------------------------|----|---------------------|----|---|----|----------|
| 11                      | BYPASS  | R/W  | 1     | <p>PLL Bypass</p> <p>Chooses whether the system clock is derived from the PLL output or the OSC source. If set, the clock that drives the system is the OSC source. Otherwise, the clock that drives the system is the PLL output clock divided by the system divider.</p> <p><b>Note:</b> The ADC module cannot be used when the PLL is in Bypass mode (BYPASS set to 1).</p>   |       |              |    |                           |    |                     |    |   |    |          |
| 10                      | PLLVER  | R/W  | 0     | <p>PLL Verification</p> <p>This bit controls the PLL verification timer function. If set, the verification timer is enabled and an interrupt is generated if the PLL becomes inoperative. Otherwise, the verification timer is not enabled.</p>  |       |              |    |                           |    |                     |    |   |    |          |
| 9:6                     | XTAL  | R/W  | 0xB   | <p>This field specifies the crystal value attached to the main oscillator. The encoding for this field is provided in Table 6-4 on page 78.</p>  |       |              |    |                           |    |                     |    |   |    |          |
| Oscillator-Related Bits |   |      |       |  |       |              |    |                           |    |                     |    |   |    |          |
| 5:4                     | OSCSRC  | R/W  | 0x0   | <p>Picks among the four input sources for the OSC. The values are:</p> <table border="1" style="margin-left: 40px;"> <thead> <tr> <th>Value</th> <th>Input Source</th> </tr> </thead> <tbody> <tr> <td>00</td> <td>Main oscillator (default)</td> </tr> <tr> <td>01</td> <td>Internal oscillator</td> </tr> <tr> <td>10</td> <td>Internal oscillator / 4 (this is necessary if used as input to PLL)</td> </tr> <tr> <td>11</td> <td>reserved</td> </tr> </tbody> </table> | Value | Input Source | 00 | Main oscillator (default) | 01 | Internal oscillator | 10 | Internal oscillator / 4 (this is necessary if used as input to PLL) | 11 | reserved |
| Value                   | Input Source  |      |       |  |       |              |    |                           |    |                     |    |   |    |          |
| 00                      | Main oscillator (default)   |      |       |  |       |              |    |                           |    |                     |    |   |    |          |
| 01                      | Internal oscillator   |      |       |  |       |              |    |                           |    |                     |    |   |    |          |
| 10                      | Internal oscillator / 4 (this is necessary if used as input to PLL) |      |       |  |       |              |    |                           |    |                     |    |   |    |          |
| 11                      | reserved  |      |       |  |       |              |    |                           |    |                     |    |   |    |          |
| 3                       | IOSCVER   | R/W  | 0     | <p>This bit controls the internal oscillator verification timer function. If set, the verification timer is enabled and an interrupt is generated if the timer becomes inoperative. Otherwise, the verification timer is not enabled.</p>  |       |              |    |                           |    |                     |    |   |    |          |
| 2                       | MOSCVER   | R/W  | 0     | <p>This bit controls the main oscillator verification timer function. If set, the verification timer is enabled and an interrupt is generated if the timer becomes inoperative. Otherwise, the verification timer is not enabled.</p>  |       |              |    |                           |    |                     |    |   |    |          |
| 1                       | IOSCDIS   | R/W  | 0     | <p>Internal Oscillator Disable</p> <p>0: Internal oscillator is enabled.<br/>1: Internal oscillator is disabled.</p>   |       |              |    |                           |    |                     |    |   |    |          |
| 0                       | MOSCDIS   | R/W  | 0     | <p>Main Oscillator Disable</p> <p>0: Main oscillator is enabled.<br/>1: Main oscillator is disabled.</p>   |       |              |    |                           |    |                     |    |   |    |          |

**Table 6-3. PLL Mode Control**

| PWRDN | OEN | Mode       |
|-------|-----|------------|
| 1     | X   | Power down |
| 0     | 0   | Normal     |

**Table 6-4. Default Crystal Field Values and PLL Programming**

| Crystal Number<br>(XTAL Binary Value) | Crystal Frequency (MHz) |
|---------------------------------------|-------------------------|
| 0000-0011                             | reserved                |
| 0100                                  | 3.579545 MHz            |
| 0101                                  | 3.6864 MHz              |
| 0110                                  | 4 MHz                   |
| 0111                                  | 4.096 MHz               |
| 1000                                  | 4.9152 MHz              |
| 1001                                  | 5 MHz                   |
| 1010                                  | 5.12 MHz                |
| 1011                                  | 6 MHz (reset value)     |
| 1100                                  | 6.144 MHz               |
| 1101                                  | 7.3728 MHz              |
| 1110                                  | 8 MHz                   |
| 1111                                  | 8.192 MHz               |

**Register 18: XTAL to PLL Translation (PLLCFG), offset 0x064**

This register provides a means of translating external crystal frequencies into the appropriate PLL settings. This register is initialized during the reset sequence and updated anytime that the *XTAL* field changes in the **Run-Mode Clock Configuration (RCC)** register (see page 75).

## XTAL to PLL Translation (PLLCFG)

Offset 0x064

|       |          |    |    |    |    |    |    |    |    |    |    |    |    |    |    |    |
|-------|----------|----|----|----|----|----|----|----|----|----|----|----|----|----|----|----|
|       | 31       | 30 | 29 | 28 | 27 | 26 | 25 | 24 | 23 | 22 | 21 | 20 | 19 | 18 | 17 | 16 |
|       | reserved |    |    |    |    |    |    |    |    |    |    |    |    |    |    |    |
| Type  | RO       | RO | RO | RO | RO | RO | RO | RO | RO | RO | RO | RO | RO | RO | RO | RO |
| Reset | 0        | 0  | 0  | 0  | 0  | 0  | 0  | 0  | 0  | 0  | 0  | 0  | 0  | 0  | 0  | 0  |
|       | 15       | 14 | 13 | 12 | 11 | 10 | 9  | 8  | 7  | 6  | 5  | 4  | 3  | 2  | 1  | 0  |
|       | OD       |    | F  |    |    |    |    |    |    |    |    | R  |    |    |    |    |
| Type  | RO       | RO | RO | RO | RO | RO | RO | RO | RO | RO | RO | RO | RO | RO | RO | RO |
| Reset | -        | -  | -  | -  | -  | -  | -  | -  | -  | -  | -  | -  | -  | -  | -  | -  |

| Bit/Field | Name     | Type | Reset | Description   |
|-----------|----------|------|-------|---|
| 31:16     | reserved | RO   | 0     | Reserved bits return an indeterminate value, and should never be changed. |
| 15:14     | OD       | RO   | -     | This field specifies the value supplied to the PLL's OD input.            |
| 13:5      | F        | RO   | -     | This field specifies the value supplied to the PLL's F input.             |
| 4:0       | R        | RO   | -     | This field specifies the value supplied to the PLL's R input.             |

**Register 19: Run-Mode Clock Gating Control 0 (RCGC0), offset 0x100**

**Register 20: Sleep-Mode Clock Gating Control 0 (SCGC0), offset 0x110**

**Register 21: Deep-Sleep-Mode Clock Gating Control 0 (DCGC0), offset 0x120**

These registers control the clock gating logic. Each bit controls a clock enable for a given interface, function, or unit. If set, the unit receives a clock and functions. Otherwise, the unit is unclocked and disabled (saving power). If the unit is unclocked, reads or writes to the unit will generate a bus fault. The reset state of these bits is 0 (unclocked) unless otherwise noted, so that all functional units are disabled. It is the responsibility of software to enable the ports necessary for the application. Note that these registers may contain more bits than there are interfaces, functions, or units to control. This is to assure reasonable code compatibility with other family and future parts.

**RCGC0** is the clock configuration register for running operation, **SCGC0** for Sleep operation, and **DCGC0** for Deep-Sleep operation. Setting the **ACG** bit in the **Run-Mode Clock Configuration (RCC)** register (see page 75) specifies that the system uses sleep modes.

Run-Mode, Sleep-Mode and Deep-Sleep-Mode Clock Gating Control 0 (RCGC0, SCGC0, and DCGC0)

Offset 0x100, 0x110, 0x120

|       |          |    |    |    |           |     |     |     |          |    |    |    |     |     |     |      |
|-------|----------|----|----|----|-----------|-----|-----|-----|----------|----|----|----|-----|-----|-----|------|
|       | 31       | 30 | 29 | 28 | 27        | 26  | 25  | 24  | 23       | 22 | 21 | 20 | 19  | 18  | 17  | 16   |
|       | reserved |    |    |    |           |     |     |     |          |    |    |    |     |     |     | ADC  |
| Type  | RO       | RO | RO | RO | RO        | RO  | RO  | RO  | RO       | RO | RO | RO | RO  | RO  | RO  | R/W  |
| Reset | 0        | 0  | 0  | 0  | 0         | 0   | 0   | 0   | 0        | 0  | 0  | 0  | 0   | 0   | 0   | 0    |
|       | 15       | 14 | 13 | 12 | 11        | 10  | 9   | 8   | 7        | 6  | 5  | 4  | 3   | 2   | 1   | 0    |
|       | reserved |    |    |    | MAXADCSPD |     |     |     | reserved |    |    |    | WDT | SWO | SWD | JTAG |
| Type  | RO       | RO | RO | RO | R/W       | R/W | R/W | R/W | RO       | RO | RO | RO | R/W | R/W | R/W | R/W  |
| Reset | 0        | 0  | 0  | 0  | 0         | 0   | 0   | 0   | 0        | 0  | 0  | 0  | 0   | 0   | 0   | 1    |

| Bit/Field | Name     | Type | Reset | Description   |
|-----------|----------|------|-------|---|
| 31:17     | reserved | RO   | 0     | Reserved bits return an indeterminate value, and should never be changed.   |
| 16        | ADC      | R/W  | 1     | This bit controls the clock gating for the ADC module. If set, the unit receives a clock and functions. Otherwise, the unit is unclocked and disabled. <sup>a</sup> |
| 15:12     | reserved | RO   | 0     | Reserved bits return an indeterminate value, and should never be changed.   |



| Bit/Field | Name                | Type | Reset | Description  |       |             |     |                     |     |                     |     |                     |     |                   |
|-----------|---------------------|------|-------|--|-------|-------------|-----|---------------------|-----|---------------------|-----|---------------------|-----|-------------------|
| 11:8      | MAXADCSPD           | R/W  | 0x3   | <p>This field sets the rate at which the ADC samples data. A value of 0x3 indicates the maximum rate of 1M samples per second. <i>You cannot set the rate higher than the maximum rate.</i></p> <p>You can set the sample rate by setting the MAXADCSPD bit as follows:</p> <table border="1"> <thead> <tr> <th>Value</th> <th>Sample Rate</th> </tr> </thead> <tbody> <tr> <td>0x0</td> <td>125K samples/second</td> </tr> <tr> <td>0x1</td> <td>250K samples/second</td> </tr> <tr> <td>0x2</td> <td>500K samples/second</td> </tr> <tr> <td>0x3</td> <td>1M samples/second</td> </tr> </tbody> </table> | Value | Sample Rate | 0x0 | 125K samples/second | 0x1 | 250K samples/second | 0x2 | 500K samples/second | 0x3 | 1M samples/second |
| Value     | Sample Rate         |      |       |  |       |             |     |                     |     |                     |     |                     |     |                   |
| 0x0       | 125K samples/second |      |       |  |       |             |     |                     |     |                     |     |                     |     |                   |
| 0x1       | 250K samples/second |      |       |  |       |             |     |                     |     |                     |     |                     |     |                   |
| 0x2       | 500K samples/second |      |       |  |       |             |     |                     |     |                     |     |                     |     |                   |
| 0x3       | 1M samples/second   |      |       |  |       |             |     |                     |     |                     |     |                     |     |                   |
| 7:4       | reserved            | RO   | 0     | Reserved bits return an indeterminate value, and should never be changed.  |       |             |     |                     |     |                     |     |                     |     |                   |
| 3         | WDT                 | R/W  | 0     | This bit controls the clock gating for the WDT module. If set, the unit receives a clock and functions. Otherwise, the unit is unlocked and disabled. <sup>a</sup>   |       |             |     |                     |     |                     |     |                     |     |                   |
| 2         | SWO                 | R/W  | 0     | This bit controls the clock gating for the SWO module. If set, the unit receives a clock and functions. Otherwise, the unit is unlocked and disabled. <sup>a</sup>   |       |             |     |                     |     |                     |     |                     |     |                   |
| 1         | SWD                 | R/W  | 0     | This bit controls the clock gating for the SWD module. If set, the unit receives a clock and functions. Otherwise, the unit is unlocked and disabled. <sup>a</sup>   |       |             |     |                     |     |                     |     |                     |     |                   |
| 0         | JTAG                | R/W  | 1     | This bit controls the clock gating for the JTAG module. The reset state for this bit is 1. At reset, the unit receives a clock and functions. Setting this bit to 0 leaves the unit unlocked and disabled. <sup>a</sup>  |       |             |     |                     |     |                     |     |                     |     |                   |

a. If the unit is unlocked, reads or writes to the unit will generate a bus fault.

**Register 22: Run-Mode Clock Gating Control 1 (RCGC1), offset 0x104**

**Register 23: Sleep-Mode Clock Gating Control 1 (SCGC1), offset 0x114**

**Register 24: Deep-Sleep-Mode Clock Gating Control 1 (DCGC1), offset 0x124**

These registers control the clock gating logic. Each bit controls a clock enable for a given interface, function, or unit. If set, the unit receives a clock and functions. Otherwise, the unit is unlocked and disabled (saving power). If the unit is unlocked, reads or writes to the unit will generate a bus fault. The reset state of these bits is 0 (unlocked) unless otherwise noted, so that all functional units are disabled. It is the responsibility of software to enable the ports necessary for the application. Note that these registers may contain more bits than there are interfaces, functions, or units to control. This is to assure reasonable code compatibility with other family and future parts.

**RCGC1** is the clock configuration register for running operation, **SCGC1** for Sleep operation, and **DCGC1** for Deep-Sleep operation. Setting the **ACG** bit in the **Run-Mode Clock Configuration (RCC)** register (see page 75) specifies that the system uses sleep modes.

Run-Mode, Sleep-Mode, and Deep-Sleep-Mode Clock Gating Control 1 (RCGC1, SCGC1, and DCGC1)  
Offset 0x104, 0x114, and 0x124

|       |          |    |    |     |          |    |    |    |    |    |    |     |          |       |       |       |
|-------|----------|----|----|-----|----------|----|----|----|----|----|----|-----|----------|-------|-------|-------|
|       | 31       | 30 | 29 | 28  | 27       | 26 | 25 | 24 | 23 | 22 | 21 | 20  | 19       | 18    | 17    | 16    |
|       | reserved |    |    |     |          |    |    |    |    |    |    |     |          | GPTM2 | GPTM1 | GPTM0 |
| Type  | RO       | RO | RO | RO  | RO       | RO | RO | RO | RO | RO | RO | RO  | RO       | R/W   | R/W   | R/W   |
| Reset | 0        | 0  | 0  | 0   | 0        | 0  | 0  | 0  | 0  | 0  | 0  | 0   | 0        | 0     | 0     | 0     |
|       | 15       | 14 | 13 | 12  | 11       | 10 | 9  | 8  | 7  | 6  | 5  | 4   | 3        | 2     | 1     | 0     |
|       | reserved |    |    | I2C | reserved |    |    |    |    |    |    | SSI | reserved |       | UART1 | UART0 |
| Type  | RO       | RO | RO | R/W | RO       | RO | RO | RO | RO | RO | RO | R/W | RO       | RO    | R/W   | R/W   |
| Reset | 0        | 0  | 0  | 0   | 0        | 0  | 0  | 0  | 0  | 0  | 0  | 0   | 0        | 0     | 0     | 0     |

| Bit/Field | Name     | Type | Reset | Description  |
|-----------|----------|------|-------|--|
| 31:19     | reserved | RO   | 0     | Reserved bits return an indeterminate value, and should never be changed.  |
| 18        | GPTM2    | R/W  | 0     | This bit controls the clock gating for the General Purpose Timer 2 module. If set, the unit receives a clock and functions. Otherwise, the unit is unlocked and disabled. <sup>a</sup> |
| 17        | GPTM1    | R/W  | 0     | This bit controls the clock gating for the General Purpose Timer 1 module. If set, the unit receives a clock and functions. Otherwise, the unit is unlocked and disabled. <sup>a</sup> |
| 16        | GPTM0    | R/W  | 0     | This bit controls the clock gating for the General Purpose Timer 0 module. If set, the unit receives a clock and functions. Otherwise, the unit is unlocked and disabled. <sup>a</sup> |
| 15:13     | reserved | RO   | 0     | Reserved bits return an indeterminate value, and should never be changed.  |
| 12        | I2C      | R/W  | 0     | This bit controls the clock gating for the I <sup>2</sup> C module. If set, the unit receives a clock and functions. Otherwise, the unit is unlocked and disabled. <sup>a</sup>        |

---

| Bit/Field | Name     | Type | Reset | Description  |
|-----------|----------|------|-------|--|
| 11:5      | reserved | RO   | 0     | Reserved bits return an indeterminate value, and should never be changed.  |
| 4         | SSI      | R/W  | 0     | This bit controls the clock gating for the SSI module. If set, the unit receives a clock and functions. Otherwise, the unit is unlocked and disabled. <sup>a</sup>   |
| 3:2       | reserved | RO   | 0     | Reserved bits return an indeterminate value, and should never be changed.  |
| 1         | UART1    | R/W  | 0     | This bit controls the clock gating for the UART1 module. If set, the unit receives a clock and functions. Otherwise, the unit is unlocked and disabled. <sup>a</sup> |
| 0         | UART0    | R/W  | 0     | This bit controls the clock gating for the UART0 module. If set, the unit receives a clock and functions. Otherwise, the unit is unlocked and disabled. <sup>a</sup> |

- a. If the unit is unlocked, reads or writes to the unit will generate a bus fault.

**Register 25: Run-Mode Clock Gating Control 2 (RCGC2), offset 0x108**

**Register 26: Sleep-Mode Clock Gating Control 2 (SCGC2), offset 0x118**

**Register 27: Deep-Sleep-Mode Clock Gating Control 2 (DCGC2), offset 0x128**

These registers control the clock gating logic. Each bit controls a clock enable for a given interface, function, or unit. If set, the unit receives a clock and functions. Otherwise, the unit is unlocked and disabled (saving power). If the unit is unlocked, reads or writes to the unit will generate a bus fault. The reset state of these bits is 0 (unlocked) unless otherwise noted, so that all functional units are disabled. It is the responsibility of software to enable the ports necessary for the application. Note that these registers may contain more bits than there are interfaces, functions, or units to control. This is to assure reasonable code compatibility with other family and future parts.

**RCGC2** is the clock configuration register for running operation, **SCGC2** for Sleep operation, and **DCGC2** for Deep-Sleep operation. Setting the **ACG** bit in the **Run-Mode Clock Configuration (RCC)** register (see page 75) specifies that the system uses sleep modes.

Run-Mode, Sleep-Mode, and Deep-Sleep-Mode Clock Gating Control 2 (RCGC2, SCGC2, and DCGC2)  
Offset 0x108, 0x118, and 0x128

|       |          |    |    |    |    |    |    |    |    |    |    |    |       |       |       |       |       |
|-------|----------|----|----|----|----|----|----|----|----|----|----|----|-------|-------|-------|-------|-------|
|       | 31       | 30 | 29 | 28 | 27 | 26 | 25 | 24 | 23 | 22 | 21 | 20 | 19    | 18    | 17    | 16    |       |
|       | reserved |    |    |    |    |    |    |    |    |    |    |    |       |       |       |       |       |
| Type  | RO       | RO | RO | RO | RO | RO | RO | RO | RO | RO | RO | RO | RO    | RO    | RO    | RO    |       |
| Reset | 0        | 0  | 0  | 0  | 0  | 0  | 0  | 0  | 0  | 0  | 0  | 0  | 0     | 0     | 0     | 0     |       |
|       | 15       | 14 | 13 | 12 | 11 | 10 | 9  | 8  | 7  | 6  | 5  | 4  | 3     | 2     | 1     | 0     |       |
|       | reserved |    |    |    |    |    |    |    |    |    |    |    | PORTE | PORTD | PORTC | PORTB | PORTA |
| Type  | RO       | RO | RO | RO | RO | RO | RO | RO | RO | RO | RO | RO | R/W   | R/W   | R/W   | R/W   |       |
| Reset | 0        | 0  | 0  | 0  | 0  | 0  | 0  | 0  | 0  | 0  | 0  | 0  | 0     | 0     | 0     | 0     |       |

| Bit/Field | Name     | Type | Reset | Description  |
|-----------|----------|------|-------|--|
| 31:5      | reserved | RO   | 0     | Reserved bits return an indeterminate value, and should never be changed.  |
| 4         | PORTE    | R/W  | 0     | This bit controls the clock gating for the GPIO Port E module. If set, the unit receives a clock and functions. Otherwise, the unit is unlocked and disabled. <sup>a</sup> |
| 3         | PORTD    | R/W  | 0     | This bit controls the clock gating for the GPIO Port D module. If set, the unit receives a clock and functions. Otherwise, the unit is unlocked and disabled. <sup>a</sup> |
| 2         | PORTC    | R/W  | 0     | This bit controls the clock gating for the GPIO Port C module. If set, the unit receives a clock and functions. Otherwise, the unit is unlocked and disabled. <sup>a</sup> |
| 1         | PORTB    | R/W  | 0     | This bit controls the clock gating for the GPIO Port B module. If set, the unit receives a clock and functions. Otherwise, the unit is unlocked and disabled. <sup>a</sup> |
| 0         | PORTA    | R/W  | 0     | This bit controls the clock gating for the GPIO Port A module. If set, the unit receives a clock and functions. Otherwise, the unit is unlocked and disabled. <sup>a</sup> |

a. If the unit is unlocked, reads or writes to the unit will generate a bus fault.

**Register 28: Deep-Sleep Clock Configuration (DSLPCCLKCFG), offset 0x144**

This register is used to automatically switch from the main oscillator to the internal oscillator when entering Deep-Sleep mode. The system clock source is the main oscillator by default. When this register is set, the internal oscillator is powered up and the main oscillator is powered down. When the Deep-Sleep exit event occurs, hardware brings the system clock back to the source and frequency it had at the onset of Deep-Sleep mode.

## Deep-Sleep Clock Configuration (DSLPCCLKCFG)

Offset 0x144

|       |          |    |    |    |    |    |    |    |    |    |    |    |    |    |    |      |
|-------|----------|----|----|----|----|----|----|----|----|----|----|----|----|----|----|------|
|       | 31       | 30 | 29 | 28 | 27 | 26 | 25 | 24 | 23 | 22 | 21 | 20 | 19 | 18 | 17 | 16   |
|       | reserved |    |    |    |    |    |    |    |    |    |    |    |    |    |    |      |
| Type  | RO       | RO | RO | RO | RO | RO | RO | RO | RO | RO | RO | RO | RO | RO | RO | RO   |
| Reset | 0        | 0  | 0  | 0  | 0  | 0  | 0  | 0  | 0  | 0  | 0  | 0  | 0  | 0  | 0  | 0    |
|       | 15       | 14 | 13 | 12 | 11 | 10 | 9  | 8  | 7  | 6  | 5  | 4  | 3  | 2  | 1  | 0    |
|       | reserved |    |    |    |    |    |    |    |    |    |    |    |    |    |    | IOSC |
| Type  | RO       | RO | RO | RO | RO | RO | RO | RO | RO | RO | RO | RO | RO | RO | RO | R/W  |
| Reset | 0        | 0  | 0  | 0  | 0  | 0  | 0  | 0  | 0  | 0  | 0  | 0  | 0  | 0  | 0  | 0    |

| Bit/Field | Name     | Type | Reset | Description   |
|-----------|----------|------|-------|---|
| 31:1      | Reserved | RO   | 0     | Reserved bits return an indeterminate value, and should never be changed.   |
| 0         | IOSC     | R/W  | 0     | This field allows an override of the main oscillator when Deep-Sleep mode is running. When set, this field forces the internal oscillator to be the clock source during Deep-Sleep mode. Otherwise, the main oscillator remains as the default system clock source. |

**Register 29: Clock Verification Clear (CLKVCLR), offset 0x150**

This register is provided as a means of clearing the clock verification circuits by software. Since the clock verification circuits force a known good clock to control the process, the controller is allowed the opportunity to solve the problem and clear the verification fault. This register clears all clock verification faults. To clear a clock verification fault, the VERCLR bit must be set and then cleared by software. This bit is not self-clearing.

Clock Verification Clear (CLKVCLR)

Offset 0x150

|       |          |    |    |    |    |    |    |    |    |    |    |    |    |    |    |        |
|-------|----------|----|----|----|----|----|----|----|----|----|----|----|----|----|----|--------|
|       | 31       | 30 | 29 | 28 | 27 | 26 | 25 | 24 | 23 | 22 | 21 | 20 | 19 | 18 | 17 | 16     |
|       | reserved |    |    |    |    |    |    |    |    |    |    |    |    |    |    |        |
| Type  | RO       | RO | RO | RO | RO | RO | RO | RO | RO | RO | RO | RO | RO | RO | RO | RO     |
| Reset | 0        | 0  | 0  | 0  | 0  | 0  | 0  | 0  | 0  | 0  | 0  | 0  | 0  | 0  | 0  | 0      |
|       | 15       | 14 | 13 | 12 | 11 | 10 | 9  | 8  | 7  | 6  | 5  | 4  | 3  | 2  | 1  | 0      |
|       | reserved |    |    |    |    |    |    |    |    |    |    |    |    |    |    | VERCLR |
| Type  | RO       | RO | RO | RO | RO | RO | RO | RO | RO | RO | RO | RO | RO | RO | RO | R/W    |
| Reset | 0        | 0  | 0  | 0  | 0  | 0  | 0  | 0  | 0  | 0  | 0  | 0  | 0  | 0  | 0  | 0      |

| Bit/Field | Name     | Type | Reset | Description   |
|-----------|----------|------|-------|---|
| 31:1      | Reserved | RO   | 0     | Reserved bits return an indeterminate value, and should never be changed. |
| 0         | VERCLR   | R/W  | 0     | Clear clock verification faults.  |

**Register 30: Allow Unregulated LDO to Reset the Part (LDOARST), offset 0x160**

This register is provided as a means of allowing the LDO to reset the part if the voltage goes unregulated. Use this register to choose whether to automatically reset the part if the LDO goes unregulated, based on the design tolerance for LDO fluctuation.

## Allow Unregulated LDO to Reset the Part (LDOARST)

Offset 0x160

|       |          |    |    |    |    |    |    |    |    |    |    |    |    |    |    |         |
|-------|----------|----|----|----|----|----|----|----|----|----|----|----|----|----|----|---------|
|       | 31       | 30 | 29 | 28 | 27 | 26 | 25 | 24 | 23 | 22 | 21 | 20 | 19 | 18 | 17 | 16      |
|       | reserved |    |    |    |    |    |    |    |    |    |    |    |    |    |    |         |
| Type  | RO       | RO | RO | RO | RO | RO | RO | RO | RO | RO | RO | RO | RO | RO | RO | RO      |
| Reset | 0        | 0  | 0  | 0  | 0  | 0  | 0  | 0  | 0  | 0  | 0  | 0  | 0  | 0  | 0  | 0       |
|       | 15       | 14 | 13 | 12 | 11 | 10 | 9  | 8  | 7  | 6  | 5  | 4  | 3  | 2  | 1  | 0       |
|       | reserved |    |    |    |    |    |    |    |    |    |    |    |    |    |    | LDOARST |
| Type  | RO       | RO | RO | RO | RO | RO | RO | RO | RO | RO | RO | RO | RO | RO | RO | R/W     |
| Reset | 0        | 0  | 0  | 0  | 0  | 0  | 0  | 0  | 0  | 0  | 0  | 0  | 0  | 0  | 0  | 0       |

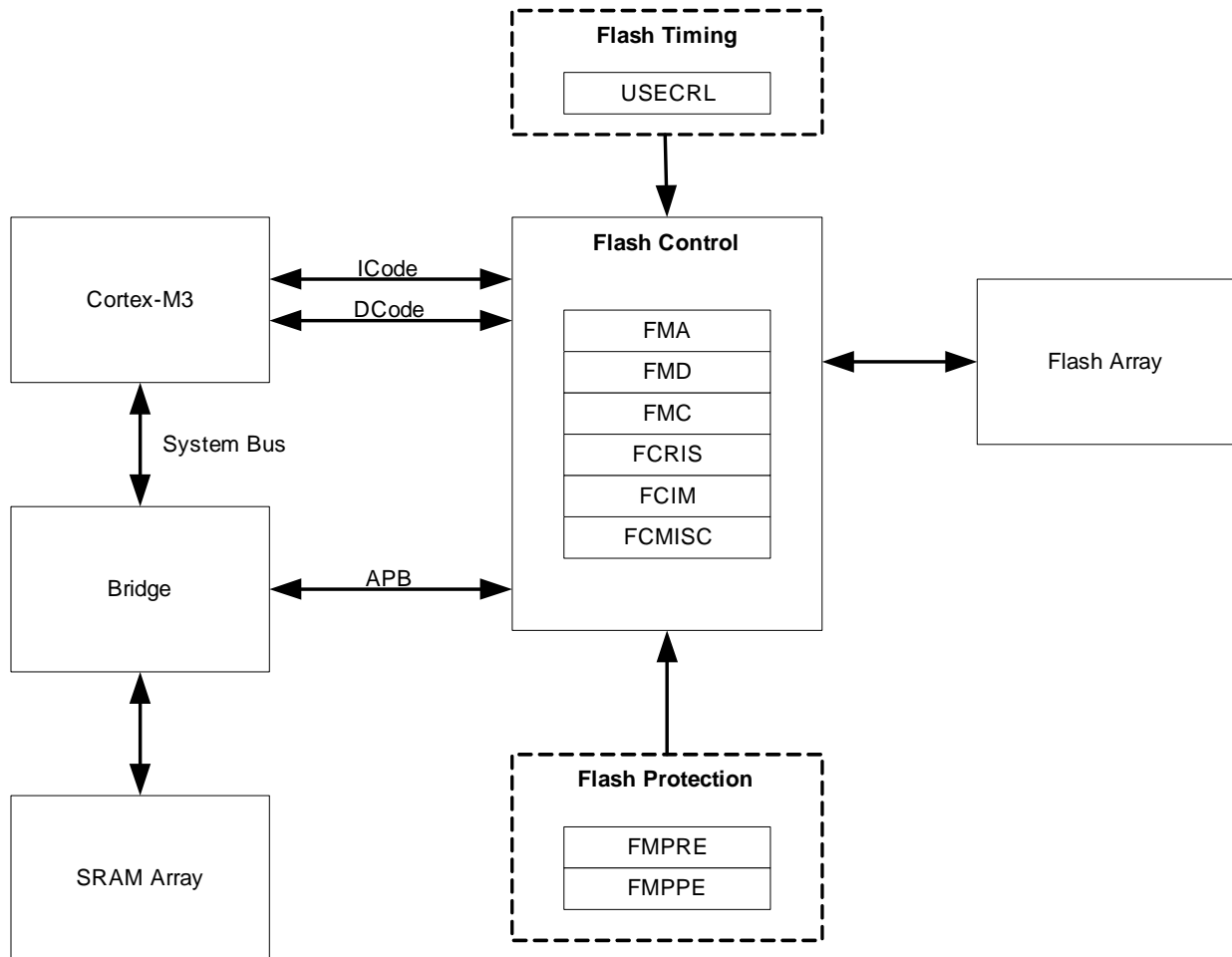
| Bit/Field | Name     | Type | Reset | Description   |
|-----------|----------|------|-------|---|
| 31:1      | Reserved | RO   | 0     | Reserved bits return an indeterminate value, and should never be changed. |
| 0         | LDOARST  | R/W  | 0     | Set to 1 to allow unregulated LDO output to reset the part.               |

## 7 Internal Memory

The LM3S628 microcontroller comes with 8 KB of bit-banded SRAM and 32 KB of flash memory. The flash controller provides a user-friendly interface, making flash programming a simple task. Flash protection can be applied to the flash memory on a 2-KB block basis.

### 7.1 Block Diagram

Figure 7-1. Flash Block Diagram



### 7.2 Functional Description

This section describes the functionality of both memories.

#### 7.2.1 SRAM Memory

The internal SRAM of the Stellaris devices is located at address 0x20000000 of the device memory map. To reduce the number of time consuming read-modify-write (RMW) operations, ARM has introduced *bit-banding* technology in the new Cortex-M3 processor. With a bit-band-enabled processor, certain regions in the memory map (SRAM and peripheral space) can use address aliases to access individual bits in a single, atomic operation.



The bit-band alias is calculated by using the formula:

$$\text{bit-band alias} = \text{bit-band base} + (\text{byte offset} * 32) + (\text{bit number} * 4)$$

For example, if bit 3 at address 0x20001000 is to be modified, the bit-band alias is calculated as:

$$0x22000000 + (0x1000 * 32) + (3 * 4) = 0x2202000C$$

With the alias address calculated, an instruction performing a read/write to address 0x2202000C allows direct access to only bit 3 of the byte at address 0x20001000.

For details about bit-banding, please refer to Chapter 4, "Memory Map" in the *ARM® Cortex™-M3 Technical Reference Manual*.

## 7.2.2 Flash Memory

The flash is organized as a set of 1-KB blocks that can be individually erased. Erasing a block causes the entire contents of the block to be reset to all 1s. These blocks are paired into a set of 2-KB blocks that can be individually protected. The blocks can be marked as read-only or execute-only, providing different levels of code protection. Read-only blocks cannot be erased or programmed, protecting the contents of those blocks from being modified. Execute-only blocks cannot be erased or programmed, and can only be read by the controller instruction fetch mechanism, protecting the contents of those blocks from being read by either the controller or by a debugger.

### 7.2.2.1 Flash Memory Timing

The timing for the flash is automatically handled by the flash controller. However, in order to do so, it must know the clock rate of the system in order to time its internal signals properly. The number of clock cycles per microsecond must be provided to the flash controller for it to accomplish this timing. It is software's responsibility to keep the flash controller updated with this information via the **Usec Reload (USECRL)** register (see page 94).

On reset, **USECRL** is loaded with a value that configures the flash timing so that it works with the selected crystal value. If software changes the system operating frequency, the new operating frequency must be loaded into **USECRL** before any flash modifications are attempted. For example, if the device is operating at a speed of 20 MHz, a value of 0x13 must be written to the **USECRL** register.

### 7.2.2.2 Flash Memory Protection

The user is provided two forms of flash protection per 2-KB flash blocks in two 32-bit wide registers. The protection policy for each form is controlled by individual bits (per policy per block) in the **FMPPE** and **FMPRE** registers (see page 93).

- **Flash Memory Protection Program Enable (FMPPE):** If set, the block may be programmed (written) or erased. If cleared, the block may not be changed.
- **Flash Memory Protection Read Enable (FMPRE):** If set, the block may be executed or read by software or debuggers. If cleared, the block may only be executed. The contents of the memory block are prohibited from being accessed as data and traversing the DCode bus.

The policies may be combined as shown in Table 7-1.

**Table 7-1. Flash Protection Policy Combinations**

| FMPPE | FMPRE | Protection   |
|-------|-------|--|
| 0     | 0     | Execute-only protection. The block may only be executed and may not be written or erased. This mode is used to protect code.   |
| 1     | 0     | The block may be written, erased or executed, but not read. This combination is unlikely to be used.   |
| 0     | 1     | Read-only protection. The block may be read or executed but may not be written or erased. This mode is used to lock the block from further modification while allowing any read or execute access. |
| 1     | 1     | No protection. The block may be written, erased, executed or read.   |

An access that attempts to program or erase a PE-protected block is prohibited. A controller interrupt may be optionally generated (by setting the `AMASK` bit in the **FIM** register) to alert software developers of poorly behaving software during the development and debug phases.

An access that attempts to read an RE-protected block is prohibited. Such accesses return data filled with all 0s. A controller interrupt may be optionally generated to alert software developers of poorly behaving software during the development and debug phases.

The factory settings for the **FMPRE** and **FMPPE** registers are a value of 1 for all implemented banks. This implements a policy of open access and programmability. The register bits may be changed by writing the specific register bit. The changes are not permanent until the register is committed (saved), at which point the bit change is permanent. If a bit is changed from a 1 to a 0 and not committed, it may be restored by executing a power-on reset sequence.

### 7.2.2.3 Flash Memory Programming

Writing the flash memory requires that the code be executed out of SRAM to avoid corrupting or interrupting the bus timing. Flash pages can be erased on a page basis (1 KB in size), or by performing a mass erase of the entire flash.

All erase and program operations are performed using the **Flash Memory Address (FMA)**, **Flash Memory Data (FMD)** and **Flash Memory Control (FMC)** registers. See section 7.3 for examples.

## 7.3 Initialization and Configuration

This section shows examples for using the flash controller to perform various operations on the contents of the flash memory.

### 7.3.1 Changing Flash Protection Bits

As discussed in Section 7.2.2.2, changes to the protection bits must be committed before they take effect. The sequence to change and commit a bit in software is as follows:

1. The **Flash Memory Protection Read Enable (FMPRE)** and **Flash Memory Protection Program Enable (FMPPE)** registers are written, changing the intended bit(s). The action of these changes can be tested by software while in this state.
2. The **Flash Memory Address (FMA)** register (see page 95) bit 0 is set to 1 if the **FMPPE** register is to be committed; otherwise, a 0 commits the **FMPRE** register.
3. The **Flash Memory Control (FMC)** register (see page 97) is written with the `COMT` bit set. This initiates a write sequence and commits the changes.

### 7.3.2 Flash Programming

The Stellaris devices provide a user-friendly interface for flash programming. All erase/program operations are handled via three registers: **FMA**, **FMD** and **FMC**.

**The flash is programmed using the following sequence:**

1. Write source data to the **FMD** register.
2. Write the target address to the **FMA** register.
3. Write the flash write key and the **WRITE** bit (a value of 0xA4420001) to the **FMC** register.
4. Poll the **FMC** register until the **WRITE** bit is cleared.

**To perform an erase of a 1-KB page:**

1. Write the page address to the **FMA** register.
2. Write the flash write key and the **ERASE** bit (a value of 0xA4420002) to the **FMC** register.
3. Poll the **FMC** register until the **ERASE** bit is cleared.

**To perform a mass erase of the flash:**

1. Write the flash write key and the **MERASE** bit (a value of 0xA4420004) to the **FMC** register.
2. Poll the **FMC** register until the **MERASE** bit is cleared.

## 7.4 Register Map

Table 7-2 lists the Flash memory and control registers. The offset listed is a hexadecimal increment to the register's address, relative to the Flash control base address of 0x400FD000, except for **FMPRE** and **FMPPE**, which are relative to the System Control base address of 0x400FE000.

**Table 7-2. Flash Register Map**

| Offset             | Name   | Reset      | Type  | Description  | See page |
|--------------------|--------|------------|-------|--|----------|
| 0x130 <sup>a</sup> | FMPRE  | 0xFFFF     | R/W0  | Flash memory read protect                          | 93       |
| 0x134 <sup>a</sup> | FMPPE  | 0xFFFF     | R/W0  | Flash memory program protect                       | 93       |
| 0x140 <sup>a</sup> | USECRL | 0x31       | R/W   | USec reload  | 94       |
| 0x000              | FMA    | 0x00000000 | R/W   | Flash memory address                               | 95       |
| 0x004              | FMD    | 0x00000000 | R/W   | Flash memory data                                  | 96       |
| 0x008              | FMC    | 0x00000000 | R/W   | Flash memory control                               | 97       |
| 0x00C              | FCRIS  | 0x00000000 | RO    | Flash controller raw interrupt status              | 99       |
| 0x010              | FCIM   | 0x00000000 | R/W   | Flash controller interrupt mask                    | 100      |
| 0x014              | FCMISC | 0x00000000 | R/W1C | Flash controller masked interrupt status and clear | 101      |

a. Relative to System Control base address of 0x400FE000.

## **7.5 Register Descriptions**

The remainder of this section lists and describes the Flash Memory registers, in numerical order by address offset.

**Register 1: Flash Memory Protection Read Enable (FMPRE), offset 0x130****Register 2: Flash Memory Protection Program Enable (FMPPE), offset 0x134**

**Note:** Offset is relative to System Control base address of 0x400FE000

These registers store the read-only (**FMPRE**) and execute-only (**FMPPE**) protection bits for each 2 KB flash block. This register is loaded during the power-on reset sequence.

The factory settings for the **FMPRE** and **FMPPE** registers are a value of 1 for all implemented banks. This implements a policy of open access and programmability. The register bits may be changed by writing the specific register bit. However, this register is R/W0; the user can only change the protection bit from a 1 to a 0 (and may NOT change a 0 to a 1).

The changes are not permanent until the register is committed (saved), at which point the bit change is permanent. If a bit is changed from a 1 to a 0 and not committed, it may be restored by executing a power-on reset sequence.

For additional information, see “Flash Memory Protection” on page 89.

## Flash Memory Protection Read Enable and Program Enable (FMPRE and FMPPE)

Offset 0x130 and 0x134

|       | 31       | 30      | 29      | 28      | 27      | 26      | 25     | 24     | 23     | 22     | 21     | 20     | 19     | 18     | 17     | 16     |
|-------|----------|---------|---------|---------|---------|---------|--------|--------|--------|--------|--------|--------|--------|--------|--------|--------|
|       | reserved |         |         |         |         |         |        |        |        |        |        |        |        |        |        |        |
| Type  | RO       | RO      | RO      | RO      | RO      | RO      | RO     | RO     | RO     | RO     | RO     | RO     | RO     | RO     | RO     | RO     |
| Reset | 0        | 0       | 0       | 0       | 0       | 0       | 0      | 0      | 0      | 0      | 0      | 0      | 0      | 0      | 0      | 0      |
|       | 15       | 14      | 13      | 12      | 11      | 10      | 9      | 8      | 7      | 6      | 5      | 4      | 3      | 2      | 1      | 0      |
|       | Block15  | Block14 | Block13 | Block12 | Block11 | Block10 | Block9 | Block8 | Block7 | Block6 | Block5 | Block4 | Block3 | Block2 | Block1 | Block0 |
| Type  | R/W0     | R/W0    | R/W0    | R/W0    | R/W0    | R/W0    | R/W0   | R/W0   | R/W0   | R/W0   | R/W0   | R/W0   | R/W0   | R/W0   | R/W0   | R/W0   |
| Reset | 1        | 1       | 1       | 1       | 1       | 1       | 1      | 1      | 1      | 1      | 1      | 1      | 1      | 1      | 1      | 1      |

| Bit/Field | Name           | Type | Reset | Description   |
|-----------|----------------|------|-------|---|
| 31:16     | reserved       | RO   | 0     | Reserved bits return an indeterminate value, and should never be changed.   |
| 15:0      | Block15-Block0 | R/W0 | 1     | Enable 2 KB flash blocks to be written or erased ( <b>FMPPE</b> register), or executed or read ( <b>FMPRE</b> register). The policies may be combined as shown in Table 7-1 on page 90. |

**Register 3: USec Reload (USECRL), offset 0x140**

**Note:** Offset is relative to System Control base address of 0x400FE000

This register is provided as a means of creating a 1  $\mu$ s tick divider reload value for the flash controller. The internal flash has specific minimum and maximum requirements on the length of time the high voltage write pulse can be applied. It is required that this register contain the operating frequency (in MHz -1) whenever the flash is being erased or programmed. The user is required to change this value if the clocking conditions are changed for a flash erase/program operation.

Usec Reload (USECRL)

Offset 0x140

|       |          |    |    |    |    |    |    |    |      |     |     |     |     |     |     |     |
|-------|----------|----|----|----|----|----|----|----|------|-----|-----|-----|-----|-----|-----|-----|
|       | 31       | 30 | 29 | 28 | 27 | 26 | 25 | 24 | 23   | 22  | 21  | 20  | 19  | 18  | 17  | 16  |
|       | reserved |    |    |    |    |    |    |    |      |     |     |     |     |     |     |     |
| Type  | RO       | RO | RO | RO | RO | RO | RO | RO | RO   | RO  | RO  | RO  | RO  | RO  | RO  | RO  |
| Reset | 0        | 0  | 0  | 0  | 0  | 0  | 0  | 0  | 0    | 0   | 0   | 0   | 0   | 0   | 0   | 0   |
|       | 15       | 14 | 13 | 12 | 11 | 10 | 9  | 8  | 7    | 6   | 5   | 4   | 3   | 2   | 1   | 0   |
|       | reserved |    |    |    |    |    |    |    | USEC |     |     |     |     |     |     |     |
| Type  | RO       | RO | RO | RO | RO | RO | RO | RO | R/W  | R/W | R/W | R/W | R/W | R/W | R/W | R/W |
| Reset | 0        | 0  | 0  | 0  | 0  | 0  | 0  | 0  | 0    | 0   | 1   | 1   | 0   | 0   | 0   | 1   |

| Bit/Field | Name     | Type | Reset | Description   |
|-----------|----------|------|-------|---|
| 31:8      | reserved | RO   | 0     | Reserved bits return an indeterminate value, and should never be changed.   |
| 7:0       | USEC     | R/W  | 0x31  | MHz -1 of the controller clock when the flash is being erased or programmed.<br><br>USEC should be set to 0x31 (49 MHz) whenever the flash is being erased or programmed. |

**Register 4: Flash Memory Address (FMA), offset 0x000**

During a write operation, this register contains a 4-byte-aligned address and specifies where the data is written. During erase operations, this register contains a 1 KB-aligned address and specifies which page is erased. Note that the alignment requirements must be met by software or the results of the operation are unpredictable.

Flash Memory Address (FMA)

Offset 0x000

|       | 31       | 30 | 29  | 28  | 27  | 26  | 25  | 24  | 23  | 22  | 21  | 20  | 19  | 18  | 17  | 16  |
|-------|----------|----|-----|-----|-----|-----|-----|-----|-----|-----|-----|-----|-----|-----|-----|-----|
|       | reserved |    |     |     |     |     |     |     |     |     |     |     |     |     |     |     |
| Type  | RO       | RO | RO  | RO  | RO  | RO  | RO  | RO  | RO  | RO  | RO  | RO  | RO  | RO  | RO  | RO  |
| Reset | 0        | 0  | 0   | 0   | 0   | 0   | 0   | 0   | 0   | 0   | 0   | 0   | 0   | 0   | 0   | 0   |
|       | 15       | 14 | 13  | 12  | 11  | 10  | 9   | 8   | 7   | 6   | 5   | 4   | 3   | 2   | 1   | 0   |
|       | OFFSET   |    |     |     |     |     |     |     |     |     |     |     |     |     |     |     |
| Type  | RO       | RO | R/W | R/W | R/W | R/W | R/W | R/W | R/W | R/W | R/W | R/W | R/W | R/W | R/W | R/W |
| Reset | 0        | 0  | 0   | 0   | 0   | 0   | 0   | 0   | 0   | 0   | 0   | 0   | 0   | 0   | 0   | 0   |

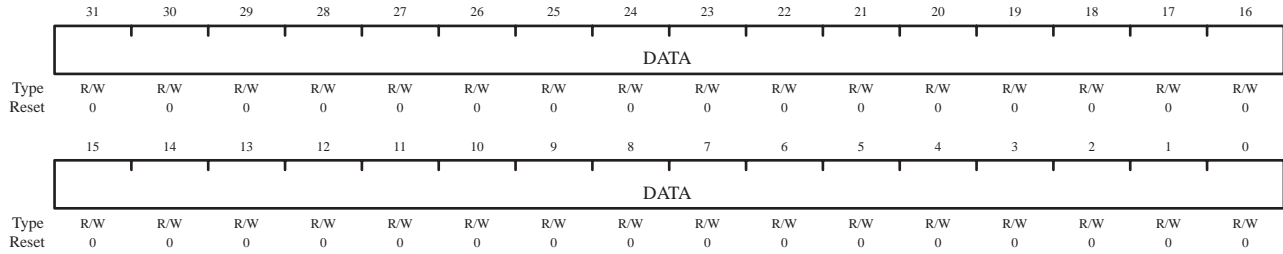
| Bit/Field | Name     | Type | Reset | Description   |
|-----------|----------|------|-------|---|
| 31:15     | reserved | RO   | 0x0   | Reserved bits return an indeterminate value, and should never be changed. |
| 14:0      | OFFSET   | R/W  | 0x0   | Address offset in flash where operation is performed.                     |

**Register 5: Flash Memory Data (FMD), offset 0x004**

This register contains the data to be written during the programming cycle or read during the read cycle. Note that the contents of this register are undefined for a read access of an execute-only block. This register is not used during the erase cycles.

Flash Memory Data (FMD)

Offset 0x004



| Bit/Field | Name | Type | Reset | Description                     |
|-----------|------|------|-------|---------------------------------|
| 31:0      | DATA | R/W  | 0x0   | Data value for write operation. |



**Register 6: Flash Memory Control (FMC), offset 0x008**

When this register is written, the flash controller initiates the appropriate access cycle for the location specified by the **Flash Memory Address (FMA)** register (see page 95). If the access is a write access, the data contained in the **Flash Memory Data (FMD)** register (see page 96) is written.

This is the final register written and initiates the memory operation. There are four control bits in the lower byte of this register that, when set, initiate the memory operation. The most used of these register bits are the **ERASE** and **WRITE** bits.

It is a programming error to write multiple control bits and the results of such an operation are unpredictable.

## Flash Memory Control (FMC)

Offset 0x008

|       |          |    |    |    |    |    |    |    |    |    |    |    |      |        |       |       |     |
|-------|----------|----|----|----|----|----|----|----|----|----|----|----|------|--------|-------|-------|-----|
|       | 31       | 30 | 29 | 28 | 27 | 26 | 25 | 24 | 23 | 22 | 21 | 20 | 19   | 18     | 17    | 16    |     |
|       | WRKEY    |    |    |    |    |    |    |    |    |    |    |    |      |        |       |       |     |
| Type  | WO       | WO | WO | WO | WO | WO | WO | WO | WO | WO | WO | WO | WO   | WO     | WO    | WO    |     |
| Reset | 0        | 0  | 0  | 0  | 0  | 0  | 0  | 0  | 0  | 0  | 0  | 0  | 0    | 0      | 0     | 0     |     |
|       | 15       | 14 | 13 | 12 | 11 | 10 | 9  | 8  | 7  | 6  | 5  | 4  | 3    | 2      | 1     | 0     |     |
|       | reserved |    |    |    |    |    |    |    |    |    |    |    | COMT | MERASE | ERASE | WRITE |     |
| Type  | RO       | RO | RO | RO | RO | RO | RO | RO | RO | RO | RO | RO | RO   | R/W    | R/W   | R/W   | R/W |
| Reset | 0        | 0  | 0  | 0  | 0  | 0  | 0  | 0  | 0  | 0  | 0  | 0  | 0    | 0      | 0     | 0     | 0   |

| Bit/Field | Name     | Type | Reset | Description   |
|-----------|----------|------|-------|---|
| 31:16     | WRKEY    | WO   | 0x0   | This field contains a write key, which is used to minimize the incidence of accidental flash writes. The value 0xA442 must be written into this field for a write to occur. Writes to the <b>FMC</b> register without this WRKEY value are ignored. A read of this field returns the value 0.   |
| 15:4      | reserved | RO   | 0     | Reserved bits return an indeterminate value, and should never be changed.   |
| 3         | COMT     | R/W  | 0     | Commit (write) of register value to nonvolatile storage. A write of 0 has no effect on the state of this bit.<br><br>If read, the state of the previous commit access is provided. If the previous commit access is complete, a 0 is returned; otherwise, if the commit access is not complete, a 1 is returned.<br><br>This can take up to 50 $\mu$ s.   |
| 2         | MERASE   | R/W  | 0     | Mass erase flash memory<br><br>If this bit is set, the flash main memory of the device is all erased. A write of 0 has no effect on the state of this bit.<br><br>If read, the state of the previous mass erase access is provided. If the previous mass erase access is complete, a 0 is returned; otherwise, if the previous mass erase access is not complete, a 1 is returned.<br><br>This can take up to 250 ms. |

| Bit/Field | Name  | Type | Reset | Description   |
|-----------|-------|------|-------|---|
| 1         | ERASE | R/W  | 0     | <p>Erase a page of flash memory</p> <p>If this bit is set, the page of flash main memory as specified by the contents of <b>FMA</b> is erased. A write of 0 has no effect on the state of this bit.</p> <p>If read, the state of the previous erase access is provided. If the previous erase access is complete, a 0 is returned; otherwise, if the previous erase access is not complete, a 1 is returned.</p> <p>This can take up to 25 ms.</p>                            |
| 0         | WRITE | R/W  | 0     | <p>Write a word into flash memory</p> <p>If this bit is set, the data stored in <b>FMD</b> is written into the location as specified by the contents of <b>FMA</b>. A write of 0 has no effect on the state of this bit.</p> <p>If read, the state of the previous write update is provided. If the previous write access is complete, a 0 is returned; otherwise, if the write access is not complete, a 1 is returned.</p> <p>This can take up to 50 <math>\mu</math>s.</p> |

**Register 7: Flash Controller Raw Interrupt Status (FCRIS), offset 0x00C**

This register indicates that the flash controller has an interrupt condition. An interrupt is only signaled if the corresponding **FCIM** register bit is set.

## Flash Controller Raw Interrupt Status (FCRIS)

Offset 0x00C

|       |          |    |    |    |    |    |    |    |    |    |    |    |    |    |      |      |
|-------|----------|----|----|----|----|----|----|----|----|----|----|----|----|----|------|------|
|       | 31       | 30 | 29 | 28 | 27 | 26 | 25 | 24 | 23 | 22 | 21 | 20 | 19 | 18 | 17   | 16   |
|       | reserved |    |    |    |    |    |    |    |    |    |    |    |    |    |      |      |
| Type  | RO       | RO | RO | RO | RO | RO | RO | RO | RO | RO | RO | RO | RO | RO | RO   | RO   |
| Reset | 0        | 0  | 0  | 0  | 0  | 0  | 0  | 0  | 0  | 0  | 0  | 0  | 0  | 0  | 0    | 0    |
|       | 15       | 14 | 13 | 12 | 11 | 10 | 9  | 8  | 7  | 6  | 5  | 4  | 3  | 2  | 1    | 0    |
|       | reserved |    |    |    |    |    |    |    |    |    |    |    |    |    | PRIS | ARIS |
| Type  | RO       | RO | RO | RO | RO | RO | RO | RO | RO | RO | RO | RO | RO | RO | RO   | RO   |
| Reset | 0        | 0  | 0  | 0  | 0  | 0  | 0  | 0  | 0  | 0  | 0  | 0  | 0  | 0  | 0    | 0    |

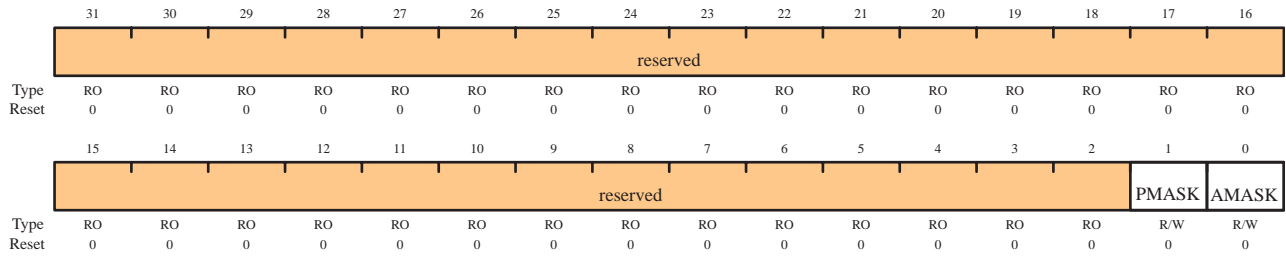
| Bit/Field | Name     | Type | Reset | Description  |
|-----------|----------|------|-------|--|
| 31:2      | reserved | RO   | 0     | Reserved bits return an indeterminate value, and should never be changed.  |
| 1         | PRIS     | RO   | 0     | Programming Raw Interrupt Status<br><br>This bit indicates the current state of the programming cycle. If set, the programming cycle completed; if cleared, the programming cycle has not completed. Programming cycles are either write or erase actions generated through the <b>Flash Memory Control (FMC)</b> register bits (see page 97).                                     |
| 0         | ARIS     | RO   | 0     | Access Raw Interrupt Status<br><br>This bit indicates if the flash was improperly accessed. If set, the program tried to access the flash counter to the policy as set in the <b>Flash Memory Protection Read Enable (FMPRE)</b> and <b>Flash Memory Protection Program Enable (FMPPE)</b> registers (see page 93). Otherwise, no access has tried to improperly access the flash. |

**Register 8: Flash Controller Interrupt Mask (FCIM), offset 0x010**

This register controls whether the flash controller generates interrupts to the controller.

Flash Controller Interrupt Mask (FCIM)

Offset 0x010



| Bit/Field | Name     | Type | Reset | Description  |
|-----------|----------|------|-------|--|
| 31:2      | reserved | RO   | 0     | Reserved bits return an indeterminate value, and should never be changed.  |
| 1         | PMASK    | R/W  | 0     | Programming Interrupt Mask<br>This bit controls the reporting of the programming raw interrupt status to the controller. If set, a programming-generated interrupt is promoted to the controller. Otherwise, interrupts are recorded but suppressed from the controller. |
| 0         | AMASK    | R/W  | 0     | Access Interrupt Mask<br>This bit controls the reporting of the access raw interrupt status to the controller. If set, an access-generated interrupt is promoted to the controller. Otherwise, interrupts are recorded but suppressed from the controller.               |

**Register 9: Flash Controller Masked Interrupt Status and Clear (FCMISC), offset 0x014**

This register provides two functions. First, it reports the cause of an interrupt by indicating which interrupt source or sources are signalling the interrupt. Second, it serves as the method to clear the interrupt reporting.

Flash Controller Masked Interrupt Status and Clear (FCMISC)

Offset 0x014

|       |          |    |    |    |    |    |    |    |    |    |    |    |    |    |       |       |       |
|-------|----------|----|----|----|----|----|----|----|----|----|----|----|----|----|-------|-------|-------|
|       | 31       | 30 | 29 | 28 | 27 | 26 | 25 | 24 | 23 | 22 | 21 | 20 | 19 | 18 | 17    | 16    |       |
|       | reserved |    |    |    |    |    |    |    |    |    |    |    |    |    |       |       |       |
| Type  | RO       | RO | RO | RO | RO | RO | RO | RO | RO | RO | RO | RO | RO | RO | RO    | RO    |       |
| Reset | 0        | 0  | 0  | 0  | 0  | 0  | 0  | 0  | 0  | 0  | 0  | 0  | 0  | 0  | 0     | 0     |       |
|       | 15       | 14 | 13 | 12 | 11 | 10 | 9  | 8  | 7  | 6  | 5  | 4  | 3  | 2  | 1     | 0     |       |
|       | reserved |    |    |    |    |    |    |    |    |    |    |    |    |    | PMISC | AMISC |       |
| Type  | RO       | RO | RO | RO | RO | RO | RO | RO | RO | RO | RO | RO | RO | RO | RO    | R/W1C | R/W1C |
| Reset | 0        | 0  | 0  | 0  | 0  | 0  | 0  | 0  | 0  | 0  | 0  | 0  | 0  | 0  | 0     | 0     | 0     |

| Bit/Field | Name     | Type  | Reset | Description  |
|-----------|----------|-------|-------|--|
| 31:2      | reserved | RO    | 0     | Reserved bits return an indeterminate value, and should never be changed.  |
| 1         | PMISC    | R/W1C | 0     | Programming Masked Interrupt Status and Clear<br>This bit indicates whether an interrupt was signaled because a programming cycle completed and was not masked. This bit is cleared by writing a 1. The <code>PRIS</code> bit in the <code>FCRIS</code> register (see page 99) is also cleared when the <code>PMISC</code> bit is cleared. |
| 0         | AMISC    | R/W1C | 0     | Access Masked Interrupt Status and Clear<br>This bit indicates whether an interrupt was signaled because an improper access was attempted and was not masked. This bit is cleared by writing a 1. The <code>ARIS</code> bit in the <code>FCRIS</code> register is also cleared when the <code>AMISC</code> bit is cleared.                 |

## 8 General-Purpose Input/Outputs (GPIOs)

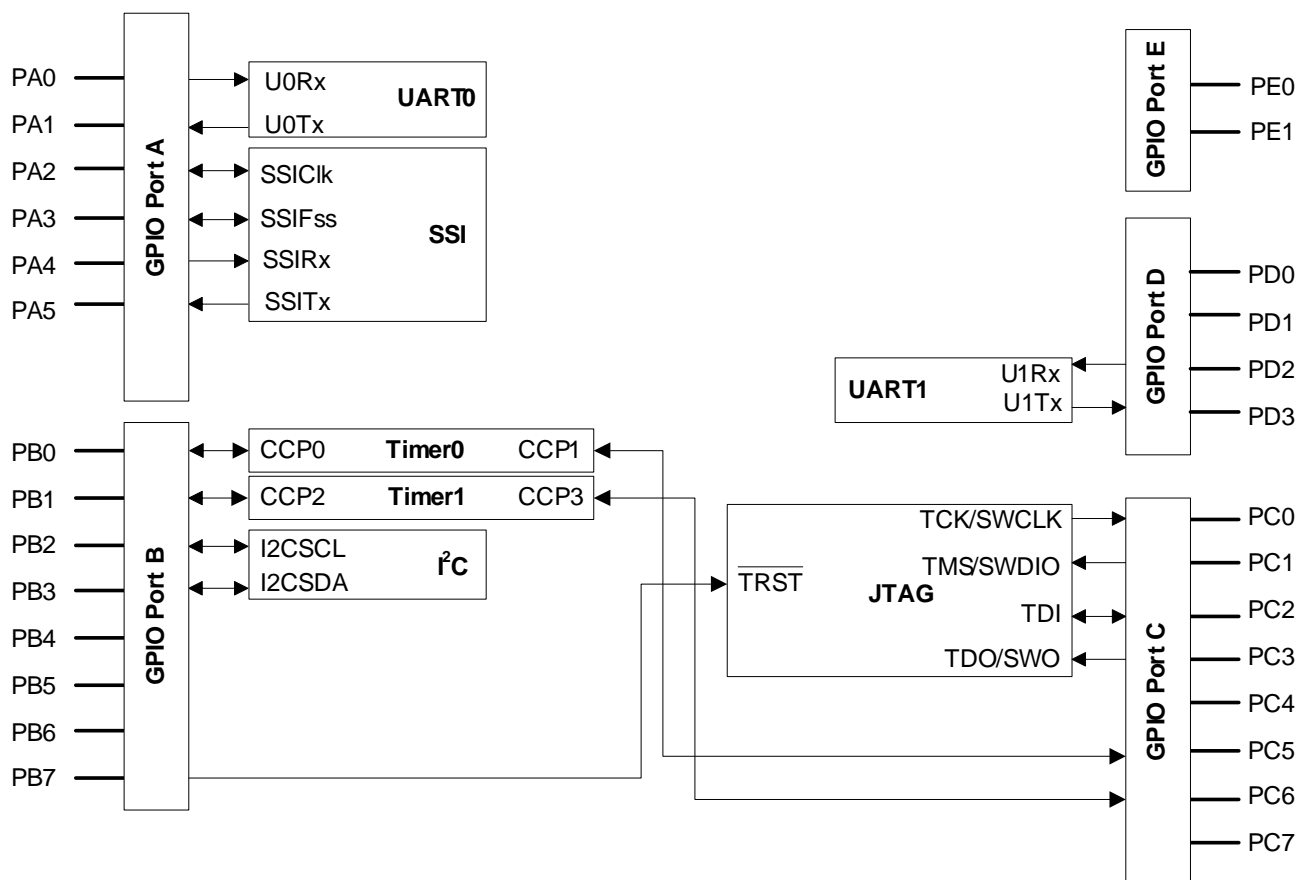
The GPIO module is composed of five physical GPIO blocks, each corresponding to an individual GPIO port (Port A, Port B, Port C, Port D, and Port E). The GPIO module is FiRM-compliant and supports 9 to 28 programmable input/output pins, depending on the peripherals being used.

The GPIO module has the following features:

- Programmable control for GPIO interrupts:
  - Interrupt generation masking
  - Edge-triggered on rising, falling, or both
  - Level-sensitive on High or Low values
- 5-V-tolerant input/outputs
- Bit masking in both read and write operations through address lines
- Programmable control for GPIO pad configuration:
  - Weak pull-up or pull-down resistors
  - 2-mA, 4-mA, and 8-mA pad drive
  - Slew rate control for the 8-mA drive
  - Open drain enables
  - Digital input enables

## 8.1 Block Diagram

Figure 8-1. GPIO Module Block Diagram

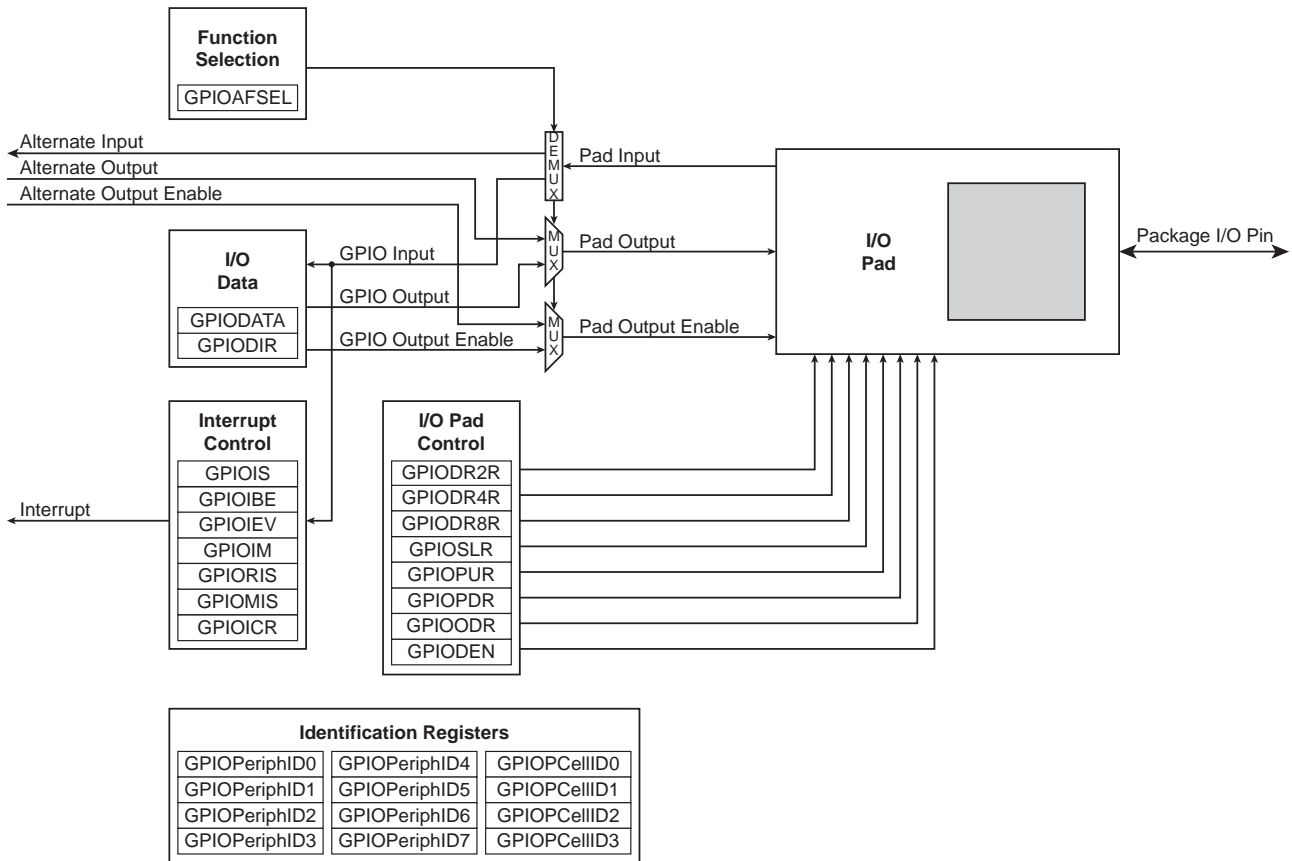


## 8.2 Functional Description

**Important:** All GPIO pins are inputs by default (**GPDIR**=0 and **GPIOAFSEL**=0), with the exception of the five JTAG pins (**PB7** and **PC[3:0]**). The JTAG pins default to their JTAG functionality (**GPIOAFSEL**=1). Asserting a Power-On-Reset (POR) or an external reset (**RST**) puts both groups of pins back to their default state.

Each GPIO port is a separate hardware instantiation of the same physical block (see Figure 8-2). The LM3S628 microcontroller contains five ports and thus five of these physical GPIO blocks.

Figure 8-2. GPIO Port Block Diagram



### 8.2.1 Data Register Operation

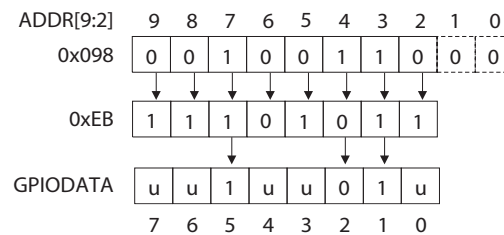
To aid in the efficiency of software, the GPIO ports allow for the modification of individual bits in the **GPIO Data (GPIODATA)** register (see page 110) by using bits [9:2] of the address bus as a mask. This allows software drivers to modify individual GPIO pins in a single instruction, without affecting the state of the other pins. This is in contrast to the "typical" method of doing a read-modify-write operation to set or clear an individual GPIO pin. To accommodate this feature, the **GPIODATA** register covers 256 locations in the memory map.

During a write, if the address bit associated with that data bit is set to 1, the value of the **GPIODATA** register is altered. If it is cleared to 0, it is left unchanged.

For example, writing a value of 0xEB to the address `GPIODATA + 0x098` would yield as shown in Figure 8-3, where u is data unchanged by the write.

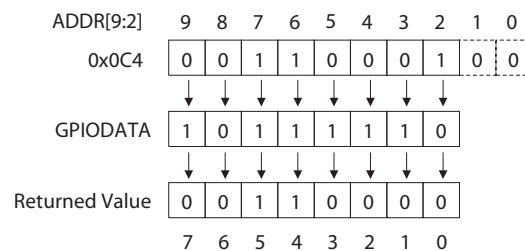


Figure 8-3. GPIODATA Write Example



During a read, if the address bit associated with the data bit is set to 1, the value is read. If the address bit associated with the data bit is set to 0, it is read as a zero, regardless of its actual value. For example, reading address GPIODATA + 0x0C4 yields as shown in Figure 8-4.

Figure 8-4. GPIODATA Read Example



## 8.2.2 Data Direction

The **GPIO Direction (GPIODIR)** register (see page 111) is used to configure each individual pin as an input or output.

## 8.2.3 Interrupt Operation

The interrupt capabilities of each GPIO port are controlled by a set of seven registers. With these registers, it is possible to select the source of the interrupt, its polarity, and the edge properties. When one or more GPIO inputs cause an interrupt, a single interrupt output is sent to the interrupt controller for the entire GPIO port. For edge-triggered interrupts, software must clear the interrupt to enable any further interrupts. For a level-sensitive interrupt, it is assumed that the external source holds the level constant for the interrupt to be recognized by the controller.

Three registers are required to define the edge or sense that causes interrupts:

- **GPIO Interrupt Sense (GPIOIS)** register (see page 112)
- **GPIO Interrupt Both Edges (GPIOIBE)** register (see page 113)
- **GPIO Interrupt Event (GPIOIEV)** register (see page 114)

Interrupts are enabled/disabled via the **GPIO Interrupt Mask (GPIOIM)** register (see page 115). When an interrupt condition occurs, the state of the interrupt signal can be viewed in two locations: the **GPIO Raw Interrupt Status (GPIORIS)** and **GPIO Masked Interrupt Status (GPIOMIS)** registers (see pages 116 and 117). As the name implies, the **GPIOMIS** register only shows interrupt conditions that are allowed to be passed to the controller. The **GPIORIS** register indicates that a GPIO pin meets the conditions for an interrupt, but has not necessarily been sent to the controller.

In addition to providing GPIO functionality, PB4 can also be used as an external trigger for the ADC. If PB4 is configured as a non-masked interrupt pin (**GPIOIM** is set to 1), not only is an interrupt for PortB generated, but an external trigger signal is sent to the ADC. If the **ADC Event Multiplexer Select (ADCEMUX)** register is configured to use the external trigger, an ADC conversion is initiated.

If no other PortB pins are being used to generate interrupts, the ARM Integrated Nested Vectored Interrupt Controller (NVIC) Interrupt Set Enable (SETNA) register can disable the PortB interrupts and the ADC interrupt can be used to read back the converted data. Otherwise, the PortB interrupt handler needs to ignore and clear interrupts on B4, and wait for the ADC interrupt or the ADC interrupt needs to be disabled in the SETNA register and the PortB interrupt handler polls the ADC registers until the conversion is completed.

Interrupts are cleared by writing a 1 to the **GPIO Interrupt Clear (GPIOICR)** register (see page 118).

When programming interrupts, the interrupts should be masked (**GPIOIM** set to 0). Writing any value to an interrupt control register (**GPIOIS**, **GPIOIBE**, or **GPIOIEV**) can generate a spurious interrupt if the corresponding bits are enabled.

### **8.2.4 Mode Control**

The GPIO pins can be controlled by either hardware or software. When hardware control is enabled via the **GPIO Alternate Function Select (GPIOAFSEL)** register (see page 119), the pin state is controlled by its alternate function (that is, the peripheral). Software control corresponds to GPIO mode, where the **GPIO DATA** register is used to read/write the corresponding pins.

### **8.2.5 Pad Configuration**

The pad configuration registers allow for GPIO pad configuration by software based on the application requirements. The pad configuration registers include the **GPIO DR2R**, **GPIO DR4R**, **GPIO DR8R**, **GPIO DR**, **GPIO PUR**, **GPIO PDR**, **GPIO SLR**, and **GPIO DEN** registers.

### **8.2.6 Identification**

The identification registers configured at reset allow software to detect and identify the module as a GPIO block. The identification registers include the **GPIO PeriphID0-GPIO PeriphID7** registers as well as the **GPIO CellID0-GPIO CellID3** registers.

## **8.3 Initialization and Configuration**

To use the GPIO, the peripheral clock must be enabled by setting **PORTA**, **PORTB**, **PORTC**, **PORTD**, and **PORTE** in the **RCGC2** register.

On reset, all GPIO pins (except for the five JTAG pins) default to general-purpose input mode (**GPIO DIR** and **GPIO AFSEL** both set to 0). Table 8-1 shows all possible configurations of the

GPIO pads and the control register settings required to achieve them. Table 8-2 shows how a rising edge interrupt would be configured for pin 2 of a GPIO port.

**Table 8-1. GPIO Pad Configuration Examples**

| Configuration                              | Register Bit Value <sup>a</sup> |         |         |         |         |         |          |          |          |         |
|--|---------------------------------|---------|---------|---------|---------|---------|----------|----------|----------|---------|
|  | GPIOAFSEL                       | GPIODIR | GPIOODR | GPIODEN | GPIOPUR | GPIOPDR | GPIODR2R | GPIODR4R | GPIODR8R | GPIOSLR |
| Digital Input (GPIO)                       | 0                               | 0       | 0       | 1       | ?       | ?       | X        | X        | X        | X       |
| Digital Output (GPIO)                      | 0                               | 1       | 0       | 1       | ?       | ?       | ?        | ?        | ?        | ?       |
| Open Drain Input (GPIO)                    | 0                               | 0       | 1       | 1       | X       | X       | X        | X        | X        | X       |
| Open Drain Output (GPIO)                   | 0                               | 1       | 1       | 1       | X       | X       | ?        | ?        | ?        | ?       |
| Open Drain Input/Output (I <sup>2</sup> C) | 1                               | X       | 1       | 1       | X       | X       | ?        | ?        | ?        | ?       |
| Digital Input (Timer CCP)                  | 1                               | X       | 0       | 1       | ?       | ?       | X        | X        | X        | X       |
| Digital Output (Timer PWM)                 | 1                               | X       | 0       | 1       | ?       | ?       | ?        | ?        | ?        | ?       |
| Digital Input/Output (SSI)                 | 1                               | X       | 0       | 1       | ?       | ?       | ?        | ?        | ?        | ?       |
| Digital Input/Output (UART)                | 1                               | X       | 0       | 1       | ?       | ?       | ?        | ?        | ?        | ?       |

- a. X=Ignored (don't care bit)  
 ?=Can be either 0 or 1, depending on the configuration

**Table 8-2. GPIO Interrupt Configuration Example**

| Register | Desired Interrupt Event Trigger                                       | Pin 2 Bit Value <sup>a</sup> |   |   |   |   |   |   |   |
|----------|---|------------------------------|---|---|---|---|---|---|---|
|          |   | 7                            | 6 | 5 | 4 | 3 | 2 | 1 | 0 |
| GPIOIS   | 0=edge<br>1=level   | X                            | X | X | X | X | 0 | X | X |
| GPIOIBE  | 0=single edge<br>1=both edges   | X                            | X | X | X | X | 0 | X | X |
| GPIOIEV  | 0=Low level, or<br>negative edge<br>1=High level, or<br>positive edge | X                            | X | X | X | X | 1 | X | X |
| GPIOIM   | 0=masked<br>1=not masked  | 0                            | 0 | 0 | 0 | 0 | 1 | 0 | 0 |

- a. X=Ignored (don't care bit)

## 8.4 Register Map

Table 8-2 lists the GPIO registers. The offset listed is a hexadecimal increment to the register's address, relative to that GPIO port's base address:

- GPIO Port A: 0x40004000
- GPIO Port B: 0x40005000
- GPIO Port C: 0x40006000
- GPIO Port D: 0x40007000
- GPIO Port E: 0x40024000

**Important:** The GPIO registers in this chapter are duplicated in each GPIO block, however, depending on the block, all eight bits may not be connected to a GPIO pad (see Figure 8-1 on page 103). In those cases, writing to those unconnected bits has no effect and reading those unconnected bits returns no meaningful data.

**Table 8-3. GPIO Register Map**

| Offset | Name          | Reset                 | Type | Description                 | See page |
|--------|---------------|-----------------------|------|-----------------------------|----------|
| 0x000  | GPIODATA      | 0x00000000            | R/W  | Data                        | 110      |
| 0x400  | GPIODIR       | 0x00000000            | R/W  | Data direction              | 111      |
| 0x404  | GPIOIS        | 0x00000000            | R/W  | Interrupt sense             | 112      |
| 0x408  | GPIOIBE       | 0x00000000            | R/W  | Interrupt both edges        | 113      |
| 0x40C  | GPIOIEV       | 0x00000000            | R/W  | Interrupt event             | 114      |
| 0x410  | GPIOIM        | 0x00000000            | R/W  | Interrupt mask enable       | 115      |
| 0x414  | GPIORIS       | 0x00000000            | RO   | Raw interrupt status        | 116      |
| 0x418  | GIOMIS        | 0x00000000            | RO   | Masked interrupt status     | 117      |
| 0x41C  | GPIOICR       | 0x00000000            | W1C  | Interrupt clear             | 118      |
| 0x420  | GPIOAFSEL     | see note <sup>a</sup> | R/W  | Alternate function select   | 119      |
| 0x500  | GPIODR2R      | 0x000000FF            | R/W  | 2-mA drive select           | 120      |
| 0x504  | GPIODR4R      | 0x00000000            | R/W  | 4-mA drive select           | 121      |
| 0x508  | GPIODR8R      | 0x00000000            | R/W  | 8-mA drive select           | 122      |
| 0x50C  | GPIOODR       | 0x00000000            | R/W  | Open drain select           | 123      |
| 0x510  | GPIOPUR       | 0x000000FF            | R/W  | Pull-up select              | 124      |
| 0x514  | GPIOPDR       | 0x00000000            | R/W  | Pull-down select            | 125      |
| 0x518  | GPIOSLR       | 0x00000000            | R/W  | Slew rate control select    | 126      |
| 0x51C  | GIODEN        | 0x000000FF            | R/W  | Digital input enable        | 127      |
| 0xFD0  | GPIOPeriphID4 | 0x00000000            | RO   | Peripheral identification 4 | 128      |

Table 8-3. GPIO Register Map (Continued)

| Offset | Name          | Reset      | Type | Description                     | See page |
|--------|---------------|------------|------|---------------------------------|----------|
| 0xFD4  | GPIOPeriphID5 | 0x00000000 | RO   | Peripheral identification 5     | 129      |
| 0xFD8  | GPIOPeriphID6 | 0x00000000 | RO   | Peripheral identification 6     | 130      |
| 0xFDC  | GPIOPeriphID7 | 0x00000000 | RO   | Peripheral identification 7     | 131      |
| 0xFE0  | GPIOPeriphID0 | 0x00000061 | RO   | Peripheral identification 0     | 132      |
| 0xFE4  | GPIOPeriphID1 | 0x00000000 | RO   | Peripheral identification 1     | 133      |
| 0xFE8  | GPIOPeriphID2 | 0x00000018 | RO   | Peripheral identification 2     | 134      |
| 0xFEC  | GPIOPeriphID3 | 0x00000001 | RO   | Peripheral identification 3     | 135      |
| 0xFF0  | GPIOCellID0   | 0x0000000D | RO   | GPIO PrimeCell identification 0 | 136      |
| 0xFF4  | GPIOCellID1   | 0x000000F0 | RO   | GPIO PrimeCell identification 1 | 137      |
| 0xFF8  | GPIOCellID2   | 0x00000005 | RO   | GPIO PrimeCell identification 2 | 138      |
| 0xFFC  | GPIOCellID3   | 0x000000B1 | RO   | GPIO PrimeCell identification 3 | 139      |

- a. The default reset value for the **GPIOAFSEL** register is 0x00000000 for all GPIO pins, with the exception of the five JTAG pins (PB7 and PC[3:0]). These five pins default to JTAG functionality. Because of this, the default reset value of **GPIOAFSEL** for GPIO Port B is 0x00000080 while the default reset value of **GPIOAFSEL** for Port C is 0x0000000F.

## 8.5 Register Descriptions

The remainder of this section lists and describes the GPIO registers, in numerical order by address offset.

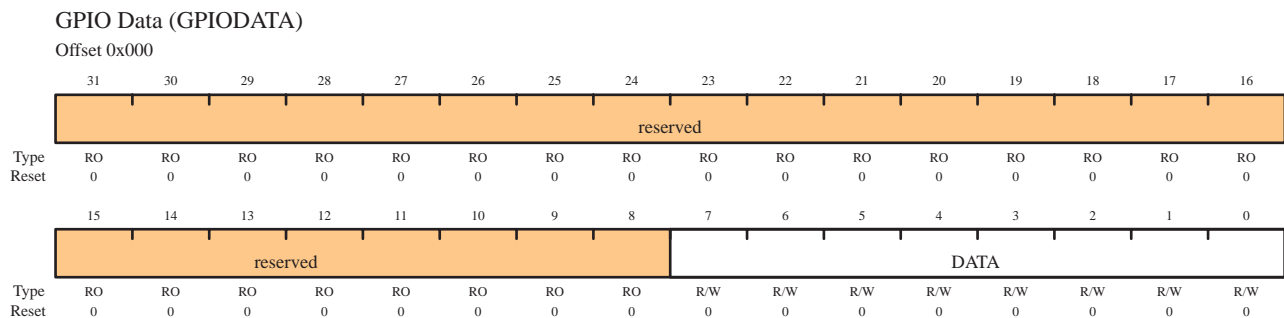
**Register 1: GPIO Data (GPIODATA), offset 0x000**

The **GPIODATA** register is the data register. In software control mode, values written in the **GPIODATA** register are transferred onto the GPIO port pins if the respective pins have been configured as outputs through the **GPIO Direction (GPIODIR)** register (see page 111).

In order to write to **GPIODATA**, the corresponding bits in the mask, resulting from the address bus bits [9:2], must be High. Otherwise, the bit values remain unchanged by the write.

Similarly, the values read from this register are determined for each bit by the mask bit derived from the address used to access the data register, bits [9:2]. Bits that are 1 in the address mask cause the corresponding bits in **GPIODATA** to be read, and bits that are 0 in the address mask cause the corresponding bits in **GPIODATA** to be read as 0, regardless of their value.

A read from **GPIODATA** returns the last bit value written if the respective pins are configured as outputs, or it returns the value on the corresponding input pin when these are configured as inputs. All bits are cleared by a reset.



| Bit/Field | Name     | Type | Reset | Description   |
|-----------|----------|------|-------|---|
| 31:8      | reserved | RO   | 0     | Reserved bits return an indeterminate value, and should never be changed. |
| 7:0       | DATA     | R/W  | 0     | GPIO Data   |

This register is virtually mapped to 256 locations in the address space. To facilitate the reading and writing of data to these registers by independent drivers, the data read from and the data written to the registers are masked by the eight address lines `ipaddr[9:2]`. Reads from this register return its current state. Writes to this register only affect bits that are not masked by `ipaddr[9:2]` and are configured as outputs. See "Data Register Operation" on page 104 for examples of reads and writes.

**Register 2: GPIO Direction (GPIODIR), offset 0x400**

The **GPIODIR** register is the data direction register. Bits set to 1 in the **GPIODIR** register configure the corresponding pin to be an output, while bits set to 0 configure the pins to be inputs. All bits are cleared by a reset, meaning all GPIO pins are inputs by default.

## GPIO Direction (GPIODIR)

Offset 0x400

|       |          |    |    |    |    |    |    |    |     |     |     |     |     |     |     |     |
|-------|----------|----|----|----|----|----|----|----|-----|-----|-----|-----|-----|-----|-----|-----|
|       | 31       | 30 | 29 | 28 | 27 | 26 | 25 | 24 | 23  | 22  | 21  | 20  | 19  | 18  | 17  | 16  |
|       | reserved |    |    |    |    |    |    |    |     |     |     |     |     |     |     |     |
| Type  | RO       | RO | RO | RO | RO | RO | RO | RO | RO  | RO  | RO  | RO  | RO  | RO  | RO  | RO  |
| Reset | 0        | 0  | 0  | 0  | 0  | 0  | 0  | 0  | 0   | 0   | 0   | 0   | 0   | 0   | 0   | 0   |
|       | 15       | 14 | 13 | 12 | 11 | 10 | 9  | 8  | 7   | 6   | 5   | 4   | 3   | 2   | 1   | 0   |
|       | reserved |    |    |    |    |    |    |    | DIR |     |     |     |     |     |     |     |
| Type  | RO       | RO | RO | RO | RO | RO | RO | RO | R/W | R/W | R/W | R/W | R/W | R/W | R/W | R/W |
| Reset | 0        | 0  | 0  | 0  | 0  | 0  | 0  | 0  | 0   | 0   | 0   | 0   | 0   | 0   | 0   | 0   |

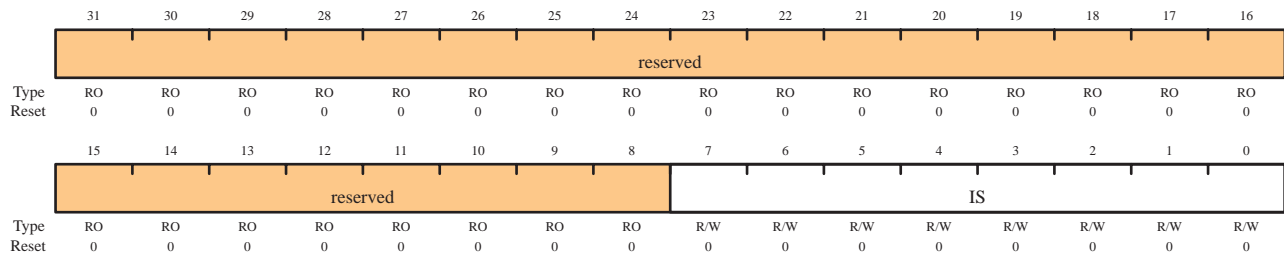
| Bit/Field | Name     | Type | Reset | Description   |
|-----------|----------|------|-------|---|
| 31:8      | reserved | RO   | 0     | Reserved bits return an indeterminate value, and should never be changed. |
| 7:0       | DIR      | R/W  | 0x00  | GPIO Data Direction<br>0: Pins are inputs.<br>1: Pins are outputs.        |

**Register 3: GPIO Interrupt Sense (GPIOIS), offset 0x404**

The **GPIOIS** register is the interrupt sense register. Bits set to 1 in **GPIOIS** configure the corresponding pins to detect levels, while bits set to 0 configure the pins to detect edges. All bits are cleared by a reset.

GPIO Interrupt Sense (GPIOIS)

Offset 0x404



| Bit/Field | Name     | Type | Reset | Description  |
|-----------|----------|------|-------|--|
| 31:8      | reserved | RO   | 0     | Reserved bits return an indeterminate value, and should never be changed.  |
| 7:0       | IS       | R/W  | 0x00  | GPIO Interrupt Sense<br>0: Edge on corresponding pin is detected (edge-sensitive).<br>1: Level on corresponding pin is detected (level-sensitive). |



**Register 4: GPIO Interrupt Both Edges (GPIOIBE), offset 0x408**

The **GPIOIBE** register is the interrupt both-edges register. When the corresponding bit in the **GPIO Interrupt Sense (GPIOIS)** register (see page 112) is set to detect edges, bits set to High in **GPIOIBE** configure the corresponding pin to detect both rising and falling edges, regardless of the corresponding bit in the **GPIO Interrupt Event (GPIOIEV)** register (see page 114). Clearing a bit configures the pin to be controlled by **GPIOIEV**. All bits are cleared by a reset.

## GPIO Interrupt Both Edges (GPIOIBE)

Offset 0x408

|       | 31       | 30 | 29 | 28 | 27 | 26 | 25 | 24 | 23  | 22  | 21  | 20  | 19  | 18  | 17  | 16  |
|-------|----------|----|----|----|----|----|----|----|-----|-----|-----|-----|-----|-----|-----|-----|
|       | reserved |    |    |    |    |    |    |    |     |     |     |     |     |     |     |     |
| Type  | RO       | RO | RO | RO | RO | RO | RO | RO | RO  | RO  | RO  | RO  | RO  | RO  | RO  | RO  |
| Reset | 0        | 0  | 0  | 0  | 0  | 0  | 0  | 0  | 0   | 0   | 0   | 0   | 0   | 0   | 0   | 0   |
|       | 15       | 14 | 13 | 12 | 11 | 10 | 9  | 8  | 7   | 6   | 5   | 4   | 3   | 2   | 1   | 0   |
|       | reserved |    |    |    |    |    |    |    | IBE |     |     |     |     |     |     |     |
| Type  | RO       | RO | RO | RO | RO | RO | RO | RO | R/W | R/W | R/W | R/W | R/W | R/W | R/W | R/W |
| Reset | 0        | 0  | 0  | 0  | 0  | 0  | 0  | 0  | 0   | 0   | 0   | 0   | 0   | 0   | 0   | 0   |

| Bit/Field | Name         | Type | Reset | Description  |
|-----------|--------------|------|-------|--|
| 31:8      | reserved     | RO   | 0     | Reserved bits return an indeterminate value, and should never be changed.  |
| 7:0       | IBE          | R/W  | 0x00  | GPIO Interrupt Both Edges<br>0: Interrupt generation is controlled by the <b>GPIO Interrupt Event (GPIOIEV)</b> register (see page 142).<br>1: Both edges on the corresponding pin trigger an interrupt. |
|           | <b>Note:</b> |      |       | Single edge is determined by the corresponding bit in <b>GPIOIEV</b> .   |

**Register 5: GPIO Interrupt Event (GPIOIEV), offset 0x40C**

The **GPIOIEV** register is the interrupt event register. Bits set to High in **GPIOIEV** configure the corresponding pin to detect rising edges or high levels, depending on the corresponding bit value in the **GPIO Interrupt Sense (GPIOIS)** register (see page 112). Clearing a bit configures the pin to detect falling edges or low levels, depending on the corresponding bit value in **GPIOIS**. All bits are cleared by a reset.

GPIO Interrupt Event (GPIOIEV)

Offset 0x40C

|       |          |    |    |    |    |    |    |    |     |     |     |     |     |     |     |     |
|-------|----------|----|----|----|----|----|----|----|-----|-----|-----|-----|-----|-----|-----|-----|
|       | 31       | 30 | 29 | 28 | 27 | 26 | 25 | 24 | 23  | 22  | 21  | 20  | 19  | 18  | 17  | 16  |
|       | reserved |    |    |    |    |    |    |    |     |     |     |     |     |     |     |     |
| Type  | RO       | RO | RO | RO | RO | RO | RO | RO | RO  | RO  | RO  | RO  | RO  | RO  | RO  | RO  |
| Reset | 0        | 0  | 0  | 0  | 0  | 0  | 0  | 0  | 0   | 0   | 0   | 0   | 0   | 0   | 0   | 0   |
|       | 15       | 14 | 13 | 12 | 11 | 10 | 9  | 8  | 7   | 6   | 5   | 4   | 3   | 2   | 1   | 0   |
|       | reserved |    |    |    |    |    |    |    | IEV |     |     |     |     |     |     |     |
| Type  | RO       | RO | RO | RO | RO | RO | RO | RO | R/W | R/W | R/W | R/W | R/W | R/W | R/W | R/W |
| Reset | 0        | 0  | 0  | 0  | 0  | 0  | 0  | 0  | 0   | 0   | 0   | 0   | 0   | 0   | 0   | 0   |

| Bit/Field | Name     | Type | Reset | Description  |
|-----------|----------|------|-------|--|
| 31:8      | reserved | RO   | 0     | Reserved bits return an indeterminate value, and should never be changed.  |
| 7:0       | IEV      | R/W  | 0x00  | GPIO Interrupt Event<br>0: Falling edge or Low levels on corresponding pins trigger interrupts.<br>1: Rising edge or High levels on corresponding pins trigger interrupts. |

**Register 6: GPIO Interrupt Mask (GPIOIM), offset 0x410**

The **GPIOIM** register is the interrupt mask register. Bits set to High in **GPIOIM** allow the corresponding pins to trigger their individual interrupts and the combined GPIOINTR line. Clearing a bit disables interrupt triggering on that pin. All bits are cleared by a reset.

## GPIO Interrupt Mask (GPIOIM)

Offset 0x410

|       | 31       | 30 | 29 | 28 | 27 | 26 | 25 | 24 | 23  | 22  | 21  | 20  | 19  | 18  | 17  | 16  |
|-------|----------|----|----|----|----|----|----|----|-----|-----|-----|-----|-----|-----|-----|-----|
|       | reserved |    |    |    |    |    |    |    |     |     |     |     |     |     |     |     |
| Type  | RO       | RO | RO | RO | RO | RO | RO | RO | RO  | RO  | RO  | RO  | RO  | RO  | RO  | RO  |
| Reset | 0        | 0  | 0  | 0  | 0  | 0  | 0  | 0  | 0   | 0   | 0   | 0   | 0   | 0   | 0   | 0   |
|       | 15       | 14 | 13 | 12 | 11 | 10 | 9  | 8  | 7   | 6   | 5   | 4   | 3   | 2   | 1   | 0   |
|       | reserved |    |    |    |    |    |    |    | IME |     |     |     |     |     |     |     |
| Type  | RO       | RO | RO | RO | RO | RO | RO | RO | R/W | R/W | R/W | R/W | R/W | R/W | R/W | R/W |
| Reset | 0        | 0  | 0  | 0  | 0  | 0  | 0  | 0  | 0   | 0   | 0   | 0   | 0   | 0   | 0   | 0   |

| Bit/Field | Name     | Type | Reset | Description  |
|-----------|----------|------|-------|--|
| 31:8      | reserved | RO   | 0     | Reserved bits return an indeterminate value, and should never be changed.  |
| 7:0       | IME      | R/W  | 0x00  | GPIO Interrupt Mask Enable<br>0: Corresponding pin interrupt is masked.<br>1: Corresponding pin interrupt is not masked. |

**Register 7: GPIO Raw Interrupt Status (GPIORIS), offset 0x414**

The **GPIORIS** register is the raw interrupt status register. Bits read High in **GPIORIS** reflect the status of interrupt trigger conditions detected (raw, prior to masking), indicating that all the requirements have been met, before they are finally allowed to trigger by the **GPIO Interrupt Mask (GPIOIM)** register (see page 115). Bits read as zero indicate that corresponding input pins have not initiated an interrupt. All bits are cleared by a reset.

GPIO Raw Interrupt Status (GPIORIS)

Offset 0x414

|       |          |    |    |    |    |    |    |    |     |    |    |    |    |    |    |    |
|-------|----------|----|----|----|----|----|----|----|-----|----|----|----|----|----|----|----|
|       | 31       | 30 | 29 | 28 | 27 | 26 | 25 | 24 | 23  | 22 | 21 | 20 | 19 | 18 | 17 | 16 |
|       | reserved |    |    |    |    |    |    |    |     |    |    |    |    |    |    |    |
| Type  | RO       | RO | RO | RO | RO | RO | RO | RO | RO  | RO | RO | RO | RO | RO | RO | RO |
| Reset | 0        | 0  | 0  | 0  | 0  | 0  | 0  | 0  | 0   | 0  | 0  | 0  | 0  | 0  | 0  | 0  |
|       | 15       | 14 | 13 | 12 | 11 | 10 | 9  | 8  | 7   | 6  | 5  | 4  | 3  | 2  | 1  | 0  |
|       | reserved |    |    |    |    |    |    |    | RIS |    |    |    |    |    |    |    |
| Type  | RO       | RO | RO | RO | RO | RO | RO | RO | RO  | RO | RO | RO | RO | RO | RO | RO |
| Reset | 0        | 0  | 0  | 0  | 0  | 0  | 0  | 0  | 0   | 0  | 0  | 0  | 0  | 0  | 0  | 0  |

| Bit/Field | Name     | Type | Reset | Description   |
|-----------|----------|------|-------|---|
| 31:8      | reserved | RO   | 0     | Reserved bits return an indeterminate value, and should never be changed.   |
| 7:0       | RIS      | RO   | 0x00  | GPIO Interrupt Raw Status<br>Reflect the status of interrupt trigger condition detection on pins (raw, prior to masking).<br>0: Corresponding pin interrupt requirements not met.<br>1: Corresponding pin interrupt has met requirements. |

**Register 8: GPIO Masked Interrupt Status (GPIOMIS), offset 0x418**

The **GPIOMIS** register is the masked interrupt status register. Bits read High in **GPIOMIS** reflect the status of input lines triggering an interrupt. Bits read as Low indicate that either no interrupt has been generated, or the interrupt is masked.

In addition to providing GPIO functionality,  $PB4$  can also be used as an external trigger for the ADC. If  $PB4$  is configured as a non-masked interrupt pin (**GPIOIM** is set to 1), not only is an interrupt for PortB generated, but an external trigger signal is sent to the ADC. If the **ADC Event Multiplexer Select (ADCEMUX)** register (see page 206) is configured to use the external trigger, an ADC conversion is initiated.

If no other PortB pins are being used to generate interrupts, the ARM Integrated Nested Vectored Interrupt Controller (NVIC) Interrupt Set Enable (SETNA) register can disable the PortB interrupts and the ADC interrupt can be used to read back the converted data. Otherwise, the PortB interrupt handler needs to ignore and clear interrupts on B4, and wait for the ADC interrupt or the ADC interrupt needs to be disabled in the SETNA register and the PortB interrupt handler polls the ADC registers until the conversion is completed.

**GPIOMIS** is the state of the interrupt after masking.

## GPIO Masked Interrupt Status (GPIOMIS)

Offset 0x418

|       |          |    |    |    |    |    |    |    |     |    |    |    |    |    |    |    |
|-------|----------|----|----|----|----|----|----|----|-----|----|----|----|----|----|----|----|
|       | 31       | 30 | 29 | 28 | 27 | 26 | 25 | 24 | 23  | 22 | 21 | 20 | 19 | 18 | 17 | 16 |
|       | reserved |    |    |    |    |    |    |    |     |    |    |    |    |    |    |    |
| Type  | RO       | RO | RO | RO | RO | RO | RO | RO | RO  | RO | RO | RO | RO | RO | RO | RO |
| Reset | 0        | 0  | 0  | 0  | 0  | 0  | 0  | 0  | 0   | 0  | 0  | 0  | 0  | 0  | 0  | 0  |
|       | 15       | 14 | 13 | 12 | 11 | 10 | 9  | 8  | 7   | 6  | 5  | 4  | 3  | 2  | 1  | 0  |
|       | reserved |    |    |    |    |    |    |    | MIS |    |    |    |    |    |    |    |
| Type  | RO       | RO | RO | RO | RO | RO | RO | RO | RO  | RO | RO | RO | RO | RO | RO | RO |
| Reset | 0        | 0  | 0  | 0  | 0  | 0  | 0  | 0  | 0   | 0  | 0  | 0  | 0  | 0  | 0  | 0  |

| Bit/Field | Name     | Type | Reset | Description  |
|-----------|----------|------|-------|--|
| 31:8      | reserved | RO   | 0     | Reserved bits return an indeterminate value, and should never be changed.  |
| 7:0       | MIS      | RO   | 0x00  | GPIO Masked Interrupt Status<br>Masked value of interrupt due to corresponding pin.<br>0: Corresponding GPIO line interrupt not active.<br>1: Corresponding GPIO line asserting interrupt. |

**Register 9: GPIO Interrupt Clear (GPIOICR), offset 0x41C**

The **GPIOICR** register is the interrupt clear register. Writing a 1 to a bit in this register clears the corresponding interrupt edge detection logic register. Writing a 0 has no effect.

GPIO Interrupt Clear (GPIOICR)

Offset 0x41C

|       |          |    |    |    |    |    |    |    |     |     |     |     |     |     |     |     |
|-------|----------|----|----|----|----|----|----|----|-----|-----|-----|-----|-----|-----|-----|-----|
|       | 31       | 30 | 29 | 28 | 27 | 26 | 25 | 24 | 23  | 22  | 21  | 20  | 19  | 18  | 17  | 16  |
|       | reserved |    |    |    |    |    |    |    |     |     |     |     |     |     |     |     |
| Type  | RO       | RO | RO | RO | RO | RO | RO | RO | RO  | RO  | RO  | RO  | RO  | RO  | RO  | RO  |
| Reset | 0        | 0  | 0  | 0  | 0  | 0  | 0  | 0  | 0   | 0   | 0   | 0   | 0   | 0   | 0   | 0   |
|       | 15       | 14 | 13 | 12 | 11 | 10 | 9  | 8  | 7   | 6   | 5   | 4   | 3   | 2   | 1   | 0   |
|       | reserved |    |    |    |    |    |    |    | IC  |     |     |     |     |     |     |     |
| Type  | RO       | RO | RO | RO | RO | RO | RO | RO | W1C | W1C | W1C | W1C | W1C | W1C | W1C | W1C |
| Reset | 0        | 0  | 0  | 0  | 0  | 0  | 0  | 0  | 0   | 0   | 0   | 0   | 0   | 0   | 0   | 0   |

| Bit/Field | Name     | Type | Reset | Description   |
|-----------|----------|------|-------|---|
| 31:8      | reserved | RO   | 0     | Reserved bits return an indeterminate value, and should never be changed.                                   |
| 7:0       | IC       | W1C  | 0x00  | GPIO Interrupt Clear<br>0: Corresponding interrupt is unaffected.<br>1: Corresponding interrupt is cleared. |

**Register 10: GPIO Alternate Function Select (GPIOAFSEL), offset 0x420**

The **GPIOAFSEL** register is the mode control select register. Writing a 1 to any bit in this register selects the hardware control for the corresponding GPIO line. All bits are cleared by a reset, therefore no GPIO line is set to hardware control by default.

**Caution** – All GPIO pins are inputs by default (**GPIO\_DIR=0** and **GPIOAFSEL=0**), with the exception of the five JTAG pins (**PB7** and **PC[3:0]**). The JTAG pins default to their **JTAG** functionality (**GPIOAFSEL=1**). Asserting a Power-On-Reset (POR) or an external reset (**RST**) puts both groups of pins back to their default state.

If the JTAG pins are used as GPIOs in a design, **PB7** and **PC2** cannot have external pull-down resistors connected to both of them at the same time. If both pins are pulled Low during reset, the controller has **unpredictable** behavior. If this happens, remove one or both of the pull-down resistors, and apply **RST** or power-cycle the part.

In addition, it is possible to create a software sequence that prevents the debugger from connecting to the Stellaris microcontroller. If the program code loaded into flash immediately changes the JTAG pins to their GPIO functionality, the debugger may not have enough time to connect and halt the controller before the JTAG pin functionality switches. This may lock the debugger out of the part. This can be avoided with a software routine that restores JTAG functionality based on an external or software trigger.

GPIO Alternate Function Select (GPIOAFSEL)

Offset 0x420

|       |          |    |    |    |    |    |    |    |       |     |     |     |     |     |     |     |
|-------|----------|----|----|----|----|----|----|----|-------|-----|-----|-----|-----|-----|-----|-----|
|       | 31       | 30 | 29 | 28 | 27 | 26 | 25 | 24 | 23    | 22  | 21  | 20  | 19  | 18  | 17  | 16  |
|       | reserved |    |    |    |    |    |    |    |       |     |     |     |     |     |     |     |
| Type  | RO       | RO | RO | RO | RO | RO | RO | RO | RO    | RO  | RO  | RO  | RO  | RO  | RO  | RO  |
| Reset | 0        | 0  | 0  | 0  | 0  | 0  | 0  | 0  | 0     | 0   | 0   | 0   | 0   | 0   | 0   | 0   |
|       | 15       | 14 | 13 | 12 | 11 | 10 | 9  | 8  | 7     | 6   | 5   | 4   | 3   | 2   | 1   | 0   |
|       | reserved |    |    |    |    |    |    |    | AFSEL |     |     |     |     |     |     |     |
| Type  | RO       | RO | RO | RO | RO | RO | RO | RO | R/W   | R/W | R/W | R/W | R/W | R/W | R/W | R/W |
| Reset | 0        | 0  | 0  | 0  | 0  | 0  | 0  | 0  | -     | -   | -   | -   | -   | -   | -   | -   |

| Bit/Field | Name     | Type | Reset    | Description  |
|-----------|----------|------|----------|--|
| 31:8      | reserved | RO   | 0        | Reserved bits return an indeterminate value, and should never be changed.  |
| 7:0       | AFSEL    | R/W  | see note | GPIO Alternate Function Select<br>0: Software control of corresponding GPIO line (GPIO mode).<br>1: Hardware control of corresponding GPIO line (alternate hardware function). |

**Note:** The default reset value for the **GPIOAFSEL** register is 0x00 for all GPIO pins, with the exception of the five JTAG pins (**PB7** and **PC[3:0]**). These five pins default to JTAG functionality. Because of this, the default reset value of **GPIOAFSEL** for GPIO Port B is 0x80 while the default reset value of **GPIOAFSEL** for Port C is 0x0F.

**Register 11: GPIO 2-mA Drive Select (GPIODR2R), offset 0x500**

The **GPIODR2R** register is the 2-mA drive control register. It allows for each GPIO signal in the port to be individually configured without affecting the other pads. When writing a **DRV2** bit for a GPIO signal, the corresponding **DRV4** bit in the **GPIODR4R** register and the **DRV8** bit in the **GPIODR8R** register are automatically cleared by hardware.

GPIO 2-mA Drive Select (GPIODR2R)

Offset 0x500

|       |          |    |    |    |    |    |    |    |      |     |     |     |     |     |     |     |
|-------|----------|----|----|----|----|----|----|----|------|-----|-----|-----|-----|-----|-----|-----|
|       | 31       | 30 | 29 | 28 | 27 | 26 | 25 | 24 | 23   | 22  | 21  | 20  | 19  | 18  | 17  | 16  |
|       | reserved |    |    |    |    |    |    |    |      |     |     |     |     |     |     |     |
| Type  | RO       | RO | RO | RO | RO | RO | RO | RO | RO   | RO  | RO  | RO  | RO  | RO  | RO  | RO  |
| Reset | 0        | 0  | 0  | 0  | 0  | 0  | 0  | 0  | 0    | 0   | 0   | 0   | 0   | 0   | 0   | 0   |
|       | 15       | 14 | 13 | 12 | 11 | 10 | 9  | 8  | 7    | 6   | 5   | 4   | 3   | 2   | 1   | 0   |
|       | reserved |    |    |    |    |    |    |    | DRV2 |     |     |     |     |     |     |     |
| Type  | RO       | RO | RO | RO | RO | RO | RO | RO | R/W  | R/W | R/W | R/W | R/W | R/W | R/W | R/W |
| Reset | 0        | 0  | 0  | 0  | 0  | 0  | 0  | 0  | 1    | 1   | 1   | 1   | 1   | 1   | 1   | 1   |

| Bit/Field | Name     | Type | Reset | Description  |
|-----------|----------|------|-------|--|
| 31:8      | reserved | RO   | 0     | Reserved bits return an indeterminate value, and should never be changed.  |
| 7:0       | DRV2     | R/W  | 0xFF  | Output Pad 2-mA Drive Enable<br>A write of 1 to either <b>GPIODR4[n]</b> or <b>GPIODR8[n]</b> clears the corresponding 2-mA enable bit. The change is effective on the second clock cycle after the write. |



**Register 12: GPIO 4-mA Drive Select (GPIODR4R), offset 0x504**

The **GPIODR4R** register is the 4-mA drive control register. It allows for each GPIO signal in the port to be individually configured without affecting the other pads. When writing the **DRV4** bit for a GPIO signal, the corresponding **DRV2** bit in the **GPIODR2R** register and the **DRV8** bit in the **GPIODR8R** register are automatically cleared by hardware.

## GPIO 4-mA Drive Select (GPIODR4R)

Offset 0x504

|       |          |    |    |    |    |    |    |    |      |     |     |     |     |     |     |     |
|-------|----------|----|----|----|----|----|----|----|------|-----|-----|-----|-----|-----|-----|-----|
|       | 31       | 30 | 29 | 28 | 27 | 26 | 25 | 24 | 23   | 22  | 21  | 20  | 19  | 18  | 17  | 16  |
|       | reserved |    |    |    |    |    |    |    |      |     |     |     |     |     |     |     |
| Type  | RO       | RO | RO | RO | RO | RO | RO | RO | RO   | RO  | RO  | RO  | RO  | RO  | RO  | RO  |
| Reset | 0        | 0  | 0  | 0  | 0  | 0  | 0  | 0  | 0    | 0   | 0   | 0   | 0   | 0   | 0   | 0   |
|       | 15       | 14 | 13 | 12 | 11 | 10 | 9  | 8  | 7    | 6   | 5   | 4   | 3   | 2   | 1   | 0   |
|       | reserved |    |    |    |    |    |    |    | DRV4 |     |     |     |     |     |     |     |
| Type  | RO       | RO | RO | RO | RO | RO | RO | RO | R/W  | R/W | R/W | R/W | R/W | R/W | R/W | R/W |
| Reset | 0        | 0  | 0  | 0  | 0  | 0  | 0  | 0  | 0    | 0   | 0   | 0   | 0   | 0   | 0   | 0   |

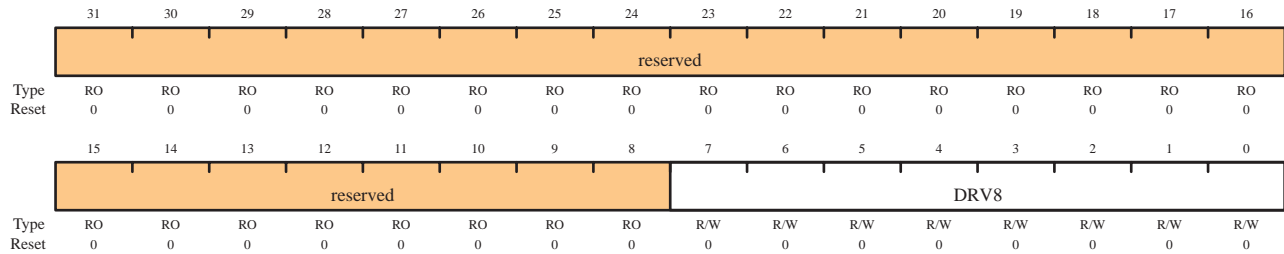
| Bit/Field | Name     | Type | Reset | Description  |
|-----------|----------|------|-------|--|
| 31:8      | reserved | RO   | 0     | Reserved bits return an indeterminate value, and should never be changed.  |
| 7:0       | DRV4     | R/W  | 0x00  | Output Pad 4-mA Drive Enable<br>A write of 1 to either <b>GPIODR2[n]</b> or <b>GPIODR8[n]</b> clears the corresponding 4-mA enable bit. The change is effective on the second clock cycle after the write. |

**Register 13: GPIO 8-mA Drive Select (GPIODR8R), offset 0x508**

The **GPIODR8R** register is the 8-mA drive control register. It allows for each GPIO signal in the port to be individually configured without affecting the other pads. When writing the **DRV8** bit for a GPIO signal, the corresponding **DRV2** bit in the **GPIODR2R** register and the **DRV4** bit in the **GPIODR4R** register are automatically cleared by hardware.

GPIO 8-mA Drive Select (GPIODR8R)

Offset 0x508



| Bit/Field | Name     | Type | Reset | Description  |
|-----------|----------|------|-------|--|
| 31:8      | reserved | RO   | 0     | Reserved bits return an indeterminate value, and should never be changed.  |
| 7:0       | DRV8     | R/W  | 0x00  | Output Pad 8-mA Drive Enable<br>A write of 1 to either <b>GPIODR2[n]</b> or <b>GPIODR4[n]</b> clears the corresponding 8-mA enable bit. The change is effective on the second clock cycle after the write. |

**Register 14: GPIO Open Drain Select (GPIOODR), offset 0x50C**

The **GPIOODR** register is the open drain control register. Setting a bit in this register enables the open drain configuration of the corresponding GPIO pad. When open drain mode is enabled, the corresponding bit should also be set in the **GPIO Digital Input Enable (GPIODEN)** register (see page 127). Corresponding bits in the drive strength registers (**GPIODR2R**, **GPIODR4R**, **GPIODR8R**, and **GPIOSLR**) can be set to achieve the desired rise and fall times. The GPIO acts as an open drain input if the corresponding bit in the **GPIODIR** register is set to 0; and as an open drain output when set to 1.

When using the I<sup>2</sup>C module, the **GPIO Alternate Function Select (GPIOAFSEL)** register bit for PB2 and PB3 should be set to 1 (see examples in “Initialization and Configuration” on page 106).

## GPIO Open Drain Select (GPIOODR)

Offset 0x50C

|       |          |    |    |    |    |    |    |    |     |     |     |     |     |     |     |     |
|-------|----------|----|----|----|----|----|----|----|-----|-----|-----|-----|-----|-----|-----|-----|
|       | 31       | 30 | 29 | 28 | 27 | 26 | 25 | 24 | 23  | 22  | 21  | 20  | 19  | 18  | 17  | 16  |
|       | reserved |    |    |    |    |    |    |    |     |     |     |     |     |     |     |     |
| Type  | RO       | RO | RO | RO | RO | RO | RO | RO | RO  | RO  | RO  | RO  | RO  | RO  | RO  | RO  |
| Reset | 0        | 0  | 0  | 0  | 0  | 0  | 0  | 0  | 0   | 0   | 0   | 0   | 0   | 0   | 0   | 0   |
|       | 15       | 14 | 13 | 12 | 11 | 10 | 9  | 8  | 7   | 6   | 5   | 4   | 3   | 2   | 1   | 0   |
|       | reserved |    |    |    |    |    |    |    | ODE |     |     |     |     |     |     |     |
| Type  | RO       | RO | RO | RO | RO | RO | RO | RO | R/W | R/W | R/W | R/W | R/W | R/W | R/W | R/W |
| Reset | 0        | 0  | 0  | 0  | 0  | 0  | 0  | 0  | 0   | 0   | 0   | 0   | 0   | 0   | 0   | 0   |

| Bit/Field | Name     | Type | Reset | Description   |
|-----------|----------|------|-------|---|
| 31:8      | reserved | RO   | 0     | Reserved bits return an indeterminate value, and should never be changed.   |
| 7:0       | ODE      | R/W  | 0x00  | Output Pad Open Drain Enable<br>0: Open drain configuration is disabled.<br>1: Open drain configuration is enabled. |

**Register 15: GPIO Pull-Up Select (GPIOPUR), offset 0x510**

The **GPIOPUR** register is the pull-up control register. When a bit is set to 1, it enables a weak pull-up resistor on the corresponding GPIO signal. Setting a bit in **GPIOPUR** automatically clears the corresponding bit in the **GPIO Pull-Down Select (GPIOPDR)** register (see page 125).

GPIO Pull-Up Select (GPIOPUR)

Offset 0x510

|       |          |    |    |    |    |    |    |    |     |     |     |     |     |     |     |     |
|-------|----------|----|----|----|----|----|----|----|-----|-----|-----|-----|-----|-----|-----|-----|
|       | 31       | 30 | 29 | 28 | 27 | 26 | 25 | 24 | 23  | 22  | 21  | 20  | 19  | 18  | 17  | 16  |
|       | reserved |    |    |    |    |    |    |    |     |     |     |     |     |     |     |     |
| Type  | RO       | RO | RO | RO | RO | RO | RO | RO | RO  | RO  | RO  | RO  | RO  | RO  | RO  | RO  |
| Reset | 0        | 0  | 0  | 0  | 0  | 0  | 0  | 0  | 0   | 0   | 0   | 0   | 0   | 0   | 0   | 0   |
|       | 15       | 14 | 13 | 12 | 11 | 10 | 9  | 8  | 7   | 6   | 5   | 4   | 3   | 2   | 1   | 0   |
|       | reserved |    |    |    |    |    |    |    | PUE |     |     |     |     |     |     |     |
| Type  | RO       | RO | RO | RO | RO | RO | RO | RO | R/W | R/W | R/W | R/W | R/W | R/W | R/W | R/W |
| Reset | 0        | 0  | 0  | 0  | 0  | 0  | 0  | 0  | 1   | 1   | 1   | 1   | 1   | 1   | 1   | 1   |

| Bit/Field | Name     | Type | Reset | Description   |
|-----------|----------|------|-------|---|
| 31:8      | reserved | RO   | 0     | Reserved bits return an indeterminate value, and should never be changed.   |
| 7:0       | PUE      | R/W  | 0xFF  | Pad Weak Pull-Up Enable<br>A write of 1 to <b>GPIOPDR[n]</b> clears the corresponding <b>GPIOPUR[n]</b> enables. The change is effective on the second clock cycle after the write. |

**Register 16: GPIO Pull-Down Select (GPIOPDR), offset 0x514**

The **GPIOPDR** register is the pull-down control register. When a bit is set to 1, it enables a weak pull-down resistor on the corresponding GPIO signal. Setting a bit in **GPIOPDR** automatically clears the corresponding bit in the **GPIO Pull-Up Select (GPIOPUR)** register (see page 124).

## GPIO Pull-Down Select (GPIOPDR)

Offset 0x514

|       |          |    |    |    |    |    |    |    |     |     |     |     |     |     |     |     |
|-------|----------|----|----|----|----|----|----|----|-----|-----|-----|-----|-----|-----|-----|-----|
|       | 31       | 30 | 29 | 28 | 27 | 26 | 25 | 24 | 23  | 22  | 21  | 20  | 19  | 18  | 17  | 16  |
|       | reserved |    |    |    |    |    |    |    |     |     |     |     |     |     |     |     |
| Type  | RO       | RO | RO | RO | RO | RO | RO | RO | RO  | RO  | RO  | RO  | RO  | RO  | RO  | RO  |
| Reset | 0        | 0  | 0  | 0  | 0  | 0  | 0  | 0  | 0   | 0   | 0   | 0   | 0   | 0   | 0   | 0   |
|       | 15       | 14 | 13 | 12 | 11 | 10 | 9  | 8  | 7   | 6   | 5   | 4   | 3   | 2   | 1   | 0   |
|       | reserved |    |    |    |    |    |    |    | PDE |     |     |     |     |     |     |     |
| Type  | RO       | RO | RO | RO | RO | RO | RO | RO | R/W | R/W | R/W | R/W | R/W | R/W | R/W | R/W |
| Reset | 0        | 0  | 0  | 0  | 0  | 0  | 0  | 0  | 0   | 0   | 0   | 0   | 0   | 0   | 0   | 0   |

| Bit/Field | Name     | Type | Reset | Description   |
|-----------|----------|------|-------|---|
| 31:8      | reserved | RO   | 0     | Reserved bits return an indeterminate value, and should never be changed.   |
| 7:0       | PDE      | R/W  | 0x00  | Pad Weak Pull-Down Enable<br>A write of 1 to <b>GPIOPUR[n]</b> clears the corresponding <b>GPIOPDR[n]</b> enables. The change is effective on the second clock cycle after the write. |

**Register 17: GPIO Slew Rate Control Select (GPIOSLR), offset 0x518**

The **GPIOSLR** register is the slew rate control register. Slew rate control is only available when using the 8-mA drive strength option via the **GPIO 8-mA Drive Select (GPIODR8R)** register (see page 122).

GPIO Slew Rate Control Select (GPIOSLR)

Offset 0x518

|       |          |    |    |    |    |    |    |    |     |     |     |     |     |     |     |     |
|-------|----------|----|----|----|----|----|----|----|-----|-----|-----|-----|-----|-----|-----|-----|
|       | 31       | 30 | 29 | 28 | 27 | 26 | 25 | 24 | 23  | 22  | 21  | 20  | 19  | 18  | 17  | 16  |
|       | reserved |    |    |    |    |    |    |    |     |     |     |     |     |     |     |     |
| Type  | RO       | RO | RO | RO | RO | RO | RO | RO | RO  | RO  | RO  | RO  | RO  | RO  | RO  | RO  |
| Reset | 0        | 0  | 0  | 0  | 0  | 0  | 0  | 0  | 0   | 0   | 0   | 0   | 0   | 0   | 0   | 0   |
|       | 15       | 14 | 13 | 12 | 11 | 10 | 9  | 8  | 7   | 6   | 5   | 4   | 3   | 2   | 1   | 0   |
|       | reserved |    |    |    |    |    |    |    | SRL |     |     |     |     |     |     |     |
| Type  | RO       | RO | RO | RO | RO | RO | RO | RO | R/W | R/W | R/W | R/W | R/W | R/W | R/W | R/W |
| Reset | 0        | 0  | 0  | 0  | 0  | 0  | 0  | 0  | 0   | 0   | 0   | 0   | 0   | 0   | 0   | 0   |

| Bit/Field | Name     | Type | Reset | Description   |
|-----------|----------|------|-------|---|
| 31:8      | reserved | RO   | 0     | Reserved bits return an indeterminate value, and should never be changed.                                   |
| 7:0       | SRL      | R/W  | 0     | Slew Rate Limit Enable (8-mA drive only)<br>0: Slew rate control disabled.<br>1: Slew rate control enabled. |

**Register 18: GPIO Digital Input Enable (GPIODEN), offset 0x51C**

The **GPIODEN** register is the digital input enable register. By default, all GPIO signals are configured as digital inputs at reset.

## GPIO Digital Input Enable (GPIODEN)

Offset 0x51C

|       |          |    |    |    |    |    |    |    |     |     |     |     |     |     |     |     |
|-------|----------|----|----|----|----|----|----|----|-----|-----|-----|-----|-----|-----|-----|-----|
|       | 31       | 30 | 29 | 28 | 27 | 26 | 25 | 24 | 23  | 22  | 21  | 20  | 19  | 18  | 17  | 16  |
|       | reserved |    |    |    |    |    |    |    |     |     |     |     |     |     |     |     |
| Type  | RO       | RO | RO | RO | RO | RO | RO | RO | RO  | RO  | RO  | RO  | RO  | RO  | RO  | RO  |
| Reset | 0        | 0  | 0  | 0  | 0  | 0  | 0  | 0  | 0   | 0   | 0   | 0   | 0   | 0   | 0   | 0   |
|       | 15       | 14 | 13 | 12 | 11 | 10 | 9  | 8  | 7   | 6   | 5   | 4   | 3   | 2   | 1   | 0   |
|       | reserved |    |    |    |    |    |    |    | DEN |     |     |     |     |     |     |     |
| Type  | RO       | RO | RO | RO | RO | RO | RO | RO | R/W | R/W | R/W | R/W | R/W | R/W | R/W | R/W |
| Reset | 0        | 0  | 0  | 0  | 0  | 0  | 0  | 0  | 1   | 1   | 1   | 1   | 1   | 1   | 1   | 1   |

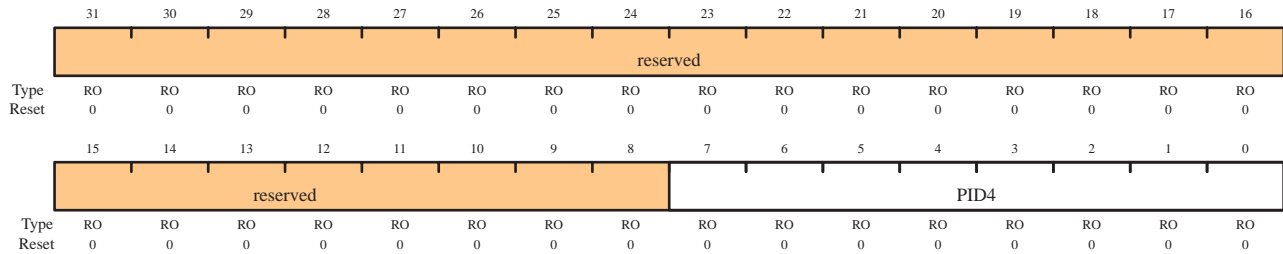
| Bit/Field | Name     | Type | Reset | Description   |
|-----------|----------|------|-------|---|
| 31:8      | reserved | RO   | 0     | Reserved bits return an indeterminate value, and should never be changed.     |
| 7:0       | DEN      | R/W  | 0xFF  | Digital-Input Enable<br>0: Digital input disabled<br>1: Digital input enabled |

**Register 19: GPIO Peripheral Identification 4 (GPIOPeriphID4), offset 0xFD0**

The **GPIOPeriphID4**, **GPIOPeriphID5**, **GPIOPeriphID6**, and **GPIOPeriphID7** registers can conceptually be treated as one 32-bit register; each register contains eight bits of the 32-bit register, used by software to identify the peripheral.

GPIO Peripheral Identification 4 (GPIOPeriphID4)

Offset 0xFD0



| Bit/Field | Name     | Type | Reset | Description   |
|-----------|----------|------|-------|---|
| 31:8      | reserved | RO   | 0     | Reserved bits return an indeterminate value, and should never be changed. |
| 7:0       | PID4     | RO   | 0x00  | GPIO Peripheral ID Register[7:0]  |



**Register 20: GPIO Peripheral Identification 5 (GPIOPeriphID5), offset 0xFD4**

The **GPIOPeriphID4**, **GPIOPeriphID5**, **GPIOPeriphID6**, and **GPIOPeriphID7** registers can conceptually be treated as one 32-bit register; each register contains eight bits of the 32-bit register, used by software to identify the peripheral.

## GPIO Peripheral Identification 5 (GPIOPeriphID5)

Offset 0xFD4

|       |          |    |    |    |    |    |    |    |      |    |    |    |    |    |    |    |
|-------|----------|----|----|----|----|----|----|----|------|----|----|----|----|----|----|----|
|       | 31       | 30 | 29 | 28 | 27 | 26 | 25 | 24 | 23   | 22 | 21 | 20 | 19 | 18 | 17 | 16 |
|       | reserved |    |    |    |    |    |    |    |      |    |    |    |    |    |    |    |
| Type  | RO       | RO | RO | RO | RO | RO | RO | RO | RO   | RO | RO | RO | RO | RO | RO | RO |
| Reset | 0        | 0  | 0  | 0  | 0  | 0  | 0  | 0  | 0    | 0  | 0  | 0  | 0  | 0  | 0  | 0  |
|       | 15       | 14 | 13 | 12 | 11 | 10 | 9  | 8  | 7    | 6  | 5  | 4  | 3  | 2  | 1  | 0  |
|       | reserved |    |    |    |    |    |    |    | PID5 |    |    |    |    |    |    |    |
| Type  | RO       | RO | RO | RO | RO | RO | RO | RO | RO   | RO | RO | RO | RO | RO | RO | RO |
| Reset | 0        | 0  | 0  | 0  | 0  | 0  | 0  | 0  | 0    | 0  | 0  | 0  | 0  | 0  | 0  | 0  |

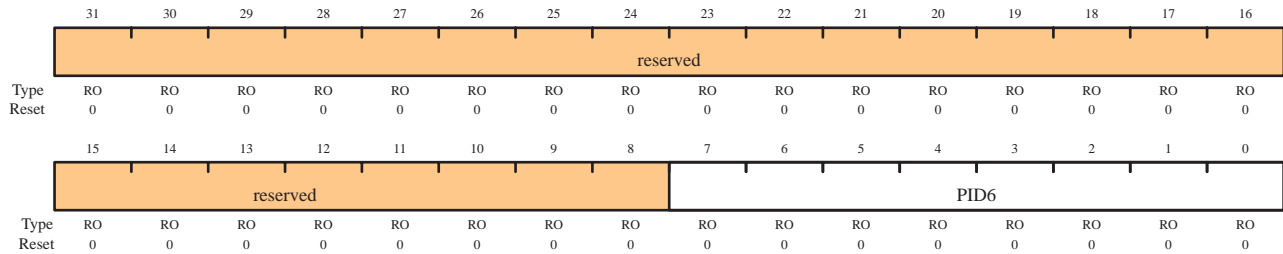
| Bit/Field | Name     | Type | Reset | Description   |
|-----------|----------|------|-------|---|
| 31:8      | reserved | RO   | 0     | Reserved bits return an indeterminate value, and should never be changed. |
| 7:0       | PID5     | RO   | 0x00  | GPIO Peripheral ID Register[15:8]   |

**Register 21: GPIO Peripheral Identification 6 (GPIOPeriphID6), offset 0xFD8**

The **GPIOPeriphID4**, **GPIOPeriphID5**, **GPIOPeriphID6**, and **GPIOPeriphID7** registers can conceptually be treated as one 32-bit register; each register contains eight bits of the 32-bit register, used by software to identify the peripheral.

GPIO Peripheral Identification 6 (GPIOPeriphID6)

Offset 0xFD8



| Bit/Field | Name     | Type | Reset | Description   |
|-----------|----------|------|-------|---|
| 31:8      | reserved | RO   | 0     | Reserved bits return an indeterminate value, and should never be changed. |
| 7:0       | PID6     | RO   | 0x00  | GPIO Peripheral ID Register[23:16]  |

**Register 22: GPIO Peripheral Identification 7 (GPIOPeriphID7), offset 0xFDC**

The **GPIOPeriphID4**, **GPIOPeriphID5**, **GPIOPeriphID6**, and **GPIOPeriphID7** registers can conceptually be treated as one 32-bit register; each register contains eight bits of the 32-bit register, used by software to identify the peripheral.

## GPIO Peripheral Identification 7 (GPIOPeriphID7)

Offset 0xFDC

|       |          |    |    |    |    |    |    |    |      |    |    |    |    |    |    |    |
|-------|----------|----|----|----|----|----|----|----|------|----|----|----|----|----|----|----|
|       | 31       | 30 | 29 | 28 | 27 | 26 | 25 | 24 | 23   | 22 | 21 | 20 | 19 | 18 | 17 | 16 |
|       | reserved |    |    |    |    |    |    |    |      |    |    |    |    |    |    |    |
| Type  | RO       | RO | RO | RO | RO | RO | RO | RO | RO   | RO | RO | RO | RO | RO | RO | RO |
| Reset | 0        | 0  | 0  | 0  | 0  | 0  | 0  | 0  | 0    | 0  | 0  | 0  | 0  | 0  | 0  | 0  |
|       | 15       | 14 | 13 | 12 | 11 | 10 | 9  | 8  | 7    | 6  | 5  | 4  | 3  | 2  | 1  | 0  |
|       | reserved |    |    |    |    |    |    |    | PID7 |    |    |    |    |    |    |    |
| Type  | RO       | RO | RO | RO | RO | RO | RO | RO | RO   | RO | RO | RO | RO | RO | RO | RO |
| Reset | 0        | 0  | 0  | 0  | 0  | 0  | 0  | 0  | 0    | 0  | 0  | 0  | 0  | 0  | 0  | 0  |

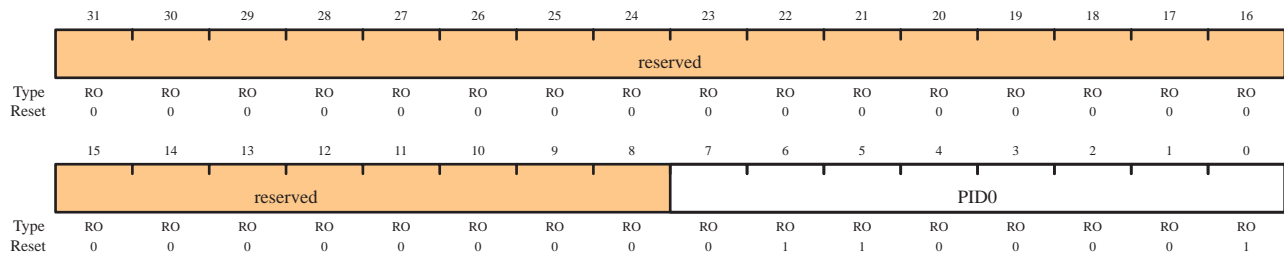
| Bit/Field | Name     | Type | Reset | Description   |
|-----------|----------|------|-------|---|
| 31:8      | reserved | RO   | 0     | Reserved bits return an indeterminate value, and should never be changed. |
| 7:0       | PID7     | RO   | 0x00  | GPIO Peripheral ID Register[31:24]  |

**Register 23: GPIO Peripheral Identification 0 (GPIOPeriphID0), offset 0xFE0**

The **GPIOPeriphID0**, **GPIOPeriphID1**, **GPIOPeriphID2**, and **GPIOPeriphID3** registers can conceptually be treated as one 32-bit register; each register contains eight bits of the 32-bit register, used by software to identify the peripheral.

GPIO Peripheral Identification 0 (GPIOPeriphID0)

Offset 0xFE0



| Bit/Field | Name     | Type | Reset | Description  |
|-----------|----------|------|-------|--|
| 31:8      | reserved | RO   | 0     | Reserved bits return an indeterminate value, and should never be changed.                                |
| 7:0       | PID0     | RO   | 0x61  | GPIO Peripheral ID Register[7:0]<br>Can be used by software to identify the presence of this peripheral. |

**Register 24: GPIO Peripheral Identification 1 (GPIOPeriphID1), offset 0xFE4**

The **GPIOPeriphID0**, **GPIOPeriphID1**, **GPIOPeriphID2**, and **GPIOPeriphID3** registers can conceptually be treated as one 32-bit register; each register contains eight bits of the 32-bit register, used by software to identify the peripheral.

## GPIO Peripheral Identification 1 (GPIOPeriphID1)

Offset 0xFE4

|       |          |    |    |    |    |    |    |    |      |    |    |    |    |    |    |    |
|-------|----------|----|----|----|----|----|----|----|------|----|----|----|----|----|----|----|
|       | 31       | 30 | 29 | 28 | 27 | 26 | 25 | 24 | 23   | 22 | 21 | 20 | 19 | 18 | 17 | 16 |
|       | reserved |    |    |    |    |    |    |    |      |    |    |    |    |    |    |    |
| Type  | RO       | RO | RO | RO | RO | RO | RO | RO | RO   | RO | RO | RO | RO | RO | RO | RO |
| Reset | 0        | 0  | 0  | 0  | 0  | 0  | 0  | 0  | 0    | 0  | 0  | 0  | 0  | 0  | 0  | 0  |
|       | 15       | 14 | 13 | 12 | 11 | 10 | 9  | 8  | 7    | 6  | 5  | 4  | 3  | 2  | 1  | 0  |
|       | reserved |    |    |    |    |    |    |    | PID1 |    |    |    |    |    |    |    |
| Type  | RO       | RO | RO | RO | RO | RO | RO | RO | RO   | RO | RO | RO | RO | RO | RO | RO |
| Reset | 0        | 0  | 0  | 0  | 0  | 0  | 0  | 0  | 0    | 0  | 0  | 0  | 0  | 0  | 0  | 0  |

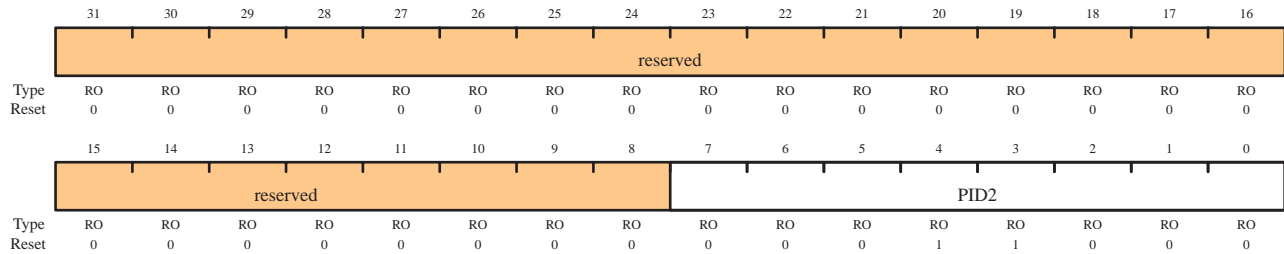
| Bit/Field | Name     | Type | Reset | Description   |
|-----------|----------|------|-------|---|
| 31:8      | reserved | RO   | 0     | Reserved bits return an indeterminate value, and should never be changed.                                 |
| 7:0       | PID1     | RO   | 0x00  | GPIO Peripheral ID Register[15:8]<br>Can be used by software to identify the presence of this peripheral. |

**Register 25: GPIO Peripheral Identification 2 (GPIOPeriphID2), offset 0xFE8**

The **GPIOPeriphID0**, **GPIOPeriphID1**, **GPIOPeriphID2**, and **GPIOPeriphID3** registers can conceptually be treated as one 32-bit register; each register contains eight bits of the 32-bit register, used by software to identify the peripheral.

GPIO Peripheral Identification 2 (GPIOPeriphID2)

Offset 0xFE8



| Bit/Field | Name     | Type | Reset | Description  |
|-----------|----------|------|-------|--|
| 31:8      | reserved | RO   | 0     | Reserved bits return an indeterminate value, and should never be changed.                                  |
| 7:0       | PID2     | RO   | 0x18  | GPIO Peripheral ID Register[23:16]<br>Can be used by software to identify the presence of this peripheral. |

**Register 26: GPIO Peripheral Identification 3 (GPIOPeriphID3), offset 0xFEC**

The **GPIOPeriphID0**, **GPIOPeriphID1**, **GPIOPeriphID2**, and **GPIOPeriphID3** registers can conceptually be treated as one 32-bit register; each register contains eight bits of the 32-bit register, used by software to identify the peripheral.

## GPIO Peripheral Identification 3 (GPIOPeriphID3)

Offset 0xFEC

|       |          |    |    |    |    |    |    |    |      |    |    |    |    |    |    |    |
|-------|----------|----|----|----|----|----|----|----|------|----|----|----|----|----|----|----|
|       | 31       | 30 | 29 | 28 | 27 | 26 | 25 | 24 | 23   | 22 | 21 | 20 | 19 | 18 | 17 | 16 |
|       | reserved |    |    |    |    |    |    |    |      |    |    |    |    |    |    |    |
| Type  | RO       | RO | RO | RO | RO | RO | RO | RO | RO   | RO | RO | RO | RO | RO | RO | RO |
| Reset | 0        | 0  | 0  | 0  | 0  | 0  | 0  | 0  | 0    | 0  | 0  | 0  | 0  | 0  | 0  | 0  |
|       | 15       | 14 | 13 | 12 | 11 | 10 | 9  | 8  | 7    | 6  | 5  | 4  | 3  | 2  | 1  | 0  |
|       | reserved |    |    |    |    |    |    |    | PID3 |    |    |    |    |    |    |    |
| Type  | RO       | RO | RO | RO | RO | RO | RO | RO | RO   | RO | RO | RO | RO | RO | RO | RO |
| Reset | 0        | 0  | 0  | 0  | 0  | 0  | 0  | 0  | 0    | 0  | 0  | 0  | 0  | 0  | 0  | 1  |

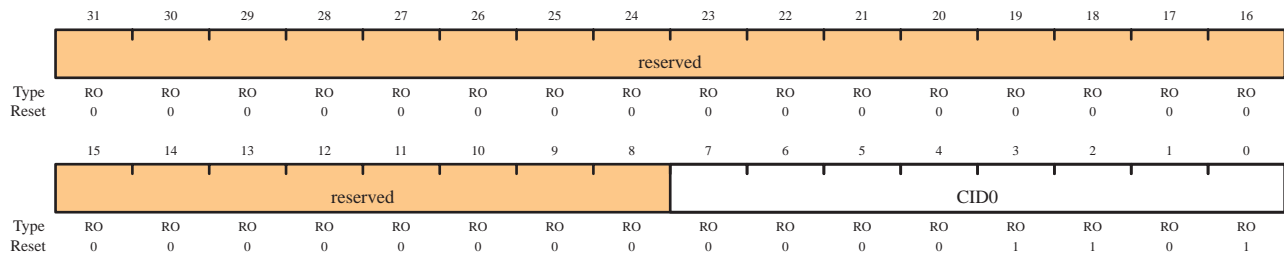
| Bit/Field | Name     | Type | Reset | Description  |
|-----------|----------|------|-------|--|
| 31:8      | reserved | RO   | 0     | Reserved bits return an indeterminate value, and should never be changed.                                  |
| 7:0       | PID3     | RO   | 0x01  | GPIO Peripheral ID Register[31:24]<br>Can be used by software to identify the presence of this peripheral. |

**Register 27: GPIO PrimeCell Identification 0 (GPIOCellID0), offset 0xFF0**

The **GPIOCellID0**, **GPIOCellID1**, **GPIOCellID2**, and **GPIOCellID3** registers are four 8-bit wide registers, that can conceptually be treated as one 32-bit register. The register is used as a standard cross-peripheral identification system.

GPIO Primecell Identification 0 (GPIOCellID0)

Offset 0xFF0



| Bit/Field | Name     | Type | Reset | Description   |
|-----------|----------|------|-------|---|
| 31:8      | reserved | RO   | 0     | Reserved bits return an indeterminate value, and should never be changed.                               |
| 7:0       | CID0     | RO   | 0x0D  | GPIO PrimeCell ID Register[7:0]<br>Provides software a standard cross-peripheral identification system. |



**Register 28: GPIO PrimeCell Identification 1 (GPIOCellID1), offset 0xFF4**

The **GPIOCellID0**, **GPIOCellID1**, **GPIOCellID2**, and **GPIOCellID3** registers are four 8-bit wide registers, that can conceptually be treated as one 32-bit register. The register is used as a standard cross-peripheral identification system.

## GPIO Primecell Identification 1 (GPIOCellID1)

Offset 0xFF4

|       |          |    |    |    |    |    |    |    |      |    |    |    |    |    |    |    |
|-------|----------|----|----|----|----|----|----|----|------|----|----|----|----|----|----|----|
|       | 31       | 30 | 29 | 28 | 27 | 26 | 25 | 24 | 23   | 22 | 21 | 20 | 19 | 18 | 17 | 16 |
|       | reserved |    |    |    |    |    |    |    |      |    |    |    |    |    |    |    |
| Type  | RO       | RO | RO | RO | RO | RO | RO | RO | RO   | RO | RO | RO | RO | RO | RO | RO |
| Reset | 0        | 0  | 0  | 0  | 0  | 0  | 0  | 0  | 0    | 0  | 0  | 0  | 0  | 0  | 0  | 0  |
|       | 15       | 14 | 13 | 12 | 11 | 10 | 9  | 8  | 7    | 6  | 5  | 4  | 3  | 2  | 1  | 0  |
|       | reserved |    |    |    |    |    |    |    | CID1 |    |    |    |    |    |    |    |
| Type  | RO       | RO | RO | RO | RO | RO | RO | RO | RO   | RO | RO | RO | RO | RO | RO | RO |
| Reset | 0        | 0  | 0  | 0  | 0  | 0  | 0  | 0  | 1    | 1  | 1  | 1  | 0  | 0  | 0  | 0  |

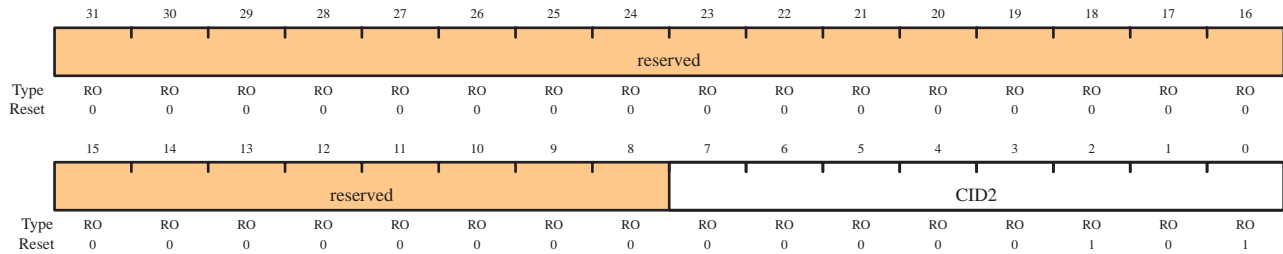
| Bit/Field | Name     | Type | Reset | Description  |
|-----------|----------|------|-------|--|
| 31:8      | reserved | RO   | 0     | Reserved bits return an indeterminate value, and should never be changed.                                |
| 7:0       | CID1     | RO   | 0xF0  | GPIO PrimeCell ID Register[15:8]<br>Provides software a standard cross-peripheral identification system. |

**Register 29: GPIO PrimeCell Identification 2 (GPIOCellID2), offset 0xFF8**

The **GPIOCellID0**, **GPIOCellID1**, **GPIOCellID2**, and **GPIOCellID3** registers are four 8-bit wide registers, that can conceptually be treated as one 32-bit register. The register is used as a standard cross-peripheral identification system.

GPIO Primecell Identification 2 (GPIOCellID2)

Offset 0xFF8



| Bit/Field | Name     | Type | Reset | Description   |
|-----------|----------|------|-------|---|
| 31:8      | reserved | RO   | 0     | Reserved bits return an indeterminate value, and should never be changed.                                 |
| 7:0       | CID2     | RO   | 0x05  | GPIO PrimeCell ID Register[23:16]<br>Provides software a standard cross-peripheral identification system. |

**Register 30: GPIO PrimeCell Identification 3 (GPIOCellID3), offset 0xFFC**

The **GPIOCellID0**, **GPIOCellID1**, **GPIOCellID2**, and **GPIOCellID3** registers are four 8-bit wide registers, that can conceptually be treated as one 32-bit register. The register is used as a standard cross-peripheral identification system.

## GPIO Primecell Identification 3 (GPIOCellID3)

Offset 0xFFC

|       |          |    |    |    |    |    |    |    |      |    |    |    |    |    |    |    |
|-------|----------|----|----|----|----|----|----|----|------|----|----|----|----|----|----|----|
|       | 31       | 30 | 29 | 28 | 27 | 26 | 25 | 24 | 23   | 22 | 21 | 20 | 19 | 18 | 17 | 16 |
|       | reserved |    |    |    |    |    |    |    |      |    |    |    |    |    |    |    |
| Type  | RO       | RO | RO | RO | RO | RO | RO | RO | RO   | RO | RO | RO | RO | RO | RO | RO |
| Reset | 0        | 0  | 0  | 0  | 0  | 0  | 0  | 0  | 0    | 0  | 0  | 0  | 0  | 0  | 0  | 0  |
|       | 15       | 14 | 13 | 12 | 11 | 10 | 9  | 8  | 7    | 6  | 5  | 4  | 3  | 2  | 1  | 0  |
|       | reserved |    |    |    |    |    |    |    | CID3 |    |    |    |    |    |    |    |
| Type  | RO       | RO | RO | RO | RO | RO | RO | RO | RO   | RO | RO | RO | RO | RO | RO | RO |
| Reset | 0        | 0  | 0  | 0  | 0  | 0  | 0  | 0  | 1    | 0  | 1  | 1  | 0  | 0  | 0  | 1  |

| Bit/Field | Name     | Type | Reset | Description   |
|-----------|----------|------|-------|---|
| 31:8      | reserved | RO   | 0     | Reserved bits return an indeterminate value, and should never be changed.                                 |
| 7:0       | CID3     | RO   | 0xB1  | GPIO PrimeCell ID Register[31:24]<br>Provides software a standard cross-peripheral identification system. |

## 9 General-Purpose Timers

Programmable timers can be used to count or time external events that drive the Timer input pins.

The LM3S628 controller General-Purpose Timer Module (GPTM) contains three GPTM blocks (Timer0, Timer1, and Timer 2). Each GPTM block provides two 16-bit timer/counters (referred to as TimerA and TimerB) that can be configured to operate independently as timers or event counters, or configured to operate as one 32-bit timer or one 32-bit Real-Time Clock (RTC). Timers can also be used to trigger analog-to-digital (ADC) conversions. The trigger signals from all of the general-purpose timers are ORed together before reaching the ADC module, so only one timer should be used to trigger ADC events.

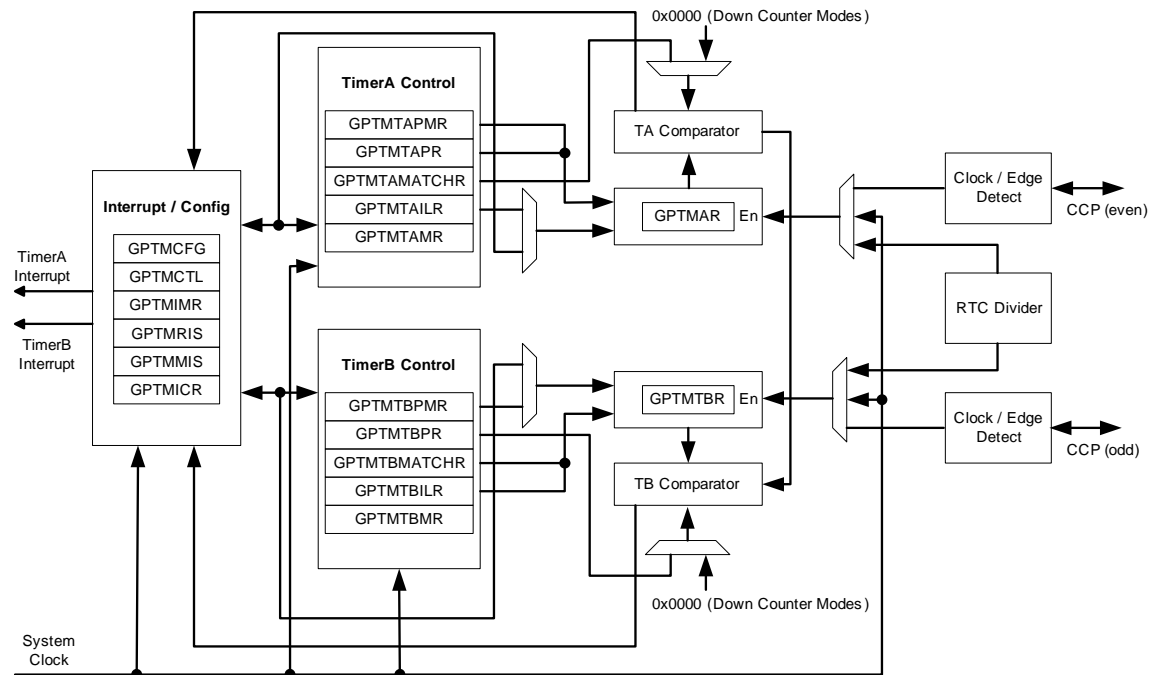
**Note:** Timer2 is an internal timer and can only be used to generate internal interrupts or trigger ADC events.

The following modes are supported:

- 32-bit Timer modes:
  - Programmable one-shot timer
  - Programmable periodic timer
  - Real-Time Clock using 32.768-KHz input clock
  - Software-controlled event stalling (excluding RTC mode)
- 16-bit Timer modes:
  - General-purpose timer function with an 8-bit prescaler
  - Programmable one-shot timer
  - Programmable periodic timer
  - Software-controlled event stalling
- 16-bit Input Capture modes:
  - Input edge count capture
  - Input edge time capture
- 16-bit PWM mode:
  - Simple PWM mode with software-programmable output inversion of the PWM signal

## 9.1 Block Diagram

Figure 9-1. GPTM Module Block Diagram



## 9.2 Functional Description

The main components of each GPTM block are two free-running 16-bit up/down counters (referred to as TimerA and TimerB), two 16-bit match registers, two prescaler match registers, and two 16-bit load/initialization registers and their associated control functions. The exact functionality of each GPTM is controlled by software and configured through the register interface.

Software configures the GPTM using the **GPTM Configuration (GPTMCFG)** register (see page 152), the **GPTM TimerA Mode (GPTMTAMR)** register (see page 153), and the **GPTM TimerB Mode (GPTMTBMR)** register (see page 154). When in one of the 32-bit modes, the timer can only act as a 32-bit timer. However, when configured in 16-bit mode, the GPTM can have its two 16-bit timers configured in any combination of the 16-bit modes.

### 9.2.1 GPTM Reset Conditions

After reset has been applied to the GPTM module, the module is in an inactive state, and all control registers are cleared and in their default states. Counters TimerA and TimerB are initialized to 0xFFFF, along with their corresponding load registers: the **GPTM TimerA Interval Load (GPTMTAILR)** register (see page 162) and the **GPTM TimerB Interval Load (GPTMTBILR)** register (see page 163). The prescale counters are initialized to 0x00: the **GPTM TimerA Prescale (GPTMTAPR)** register (see page 166) and the **GPTM TimerB Prescale (GPTMTBPR)** register (see page 167).

### 9.2.2 32-Bit Timer Operating Modes

**Note:** Both the odd- and even-numbered CCP pins are used for 16-bit mode. Only the even-numbered CCP pins are used for 32-bit mode.

This section describes the three GPTM 32-bit timer modes (One-Shot, Periodic, and RTC) and their configuration.

The GPTM is placed into 32-bit mode by writing a 0 (One-Shot/Periodic 32-bit timer mode) or a 1 (RTC mode) to the **GPTM Configuration (GPTMCFG)** register. In both configurations, certain GPTM registers are concatenated to form pseudo 32-bit registers. These registers include:

- **GPTM TimerA Interval Load (GPTMTAILR)** register [15:0], see page 162
- **GPTM TimerB Interval Load (GPTMTBILR)** register [15:0], see page 163
- **GPTM TimerA (GPTMTAR)** register [15:0], see page 170
- **GPTM TimerB (GPTMTBR)** register [15:0], see page 171

In the 32-bit modes, the GPTM translates a 32-bit write access to **GPTMTAILR** into a write access to both **GPTMTAILR** and **GPTMTBILR**. The resulting word ordering for such a write operation is: **GPTMTBILR** [15 : 0] : **GPTMTAILR** [15 : 0]. Likewise, a read access to **GPTMTAR** returns the value: **GPTMTBR** [15 : 0] : **GPTMTAR** [15 : 0].

### 9.2.2.1 32-Bit One-Shot/Periodic Timer Mode

In 32-bit one-shot and periodic timer modes, the concatenated versions of the TimerA and TimerB registers are configured as a 32-bit down-counter. The selection of one-shot or periodic mode is determined by the value written to the **TAMR** field of the **GPTM TimerA Mode (GPTMTAMR)** register (see page 153), and there is no need to write to the **GPTM TimerB Mode (GPTMTBMR)** register.

When software writes the **TAEN** bit in the **GPTM Control (GPTMCTL)** register (see page 155), the timer begins counting down from its preloaded value. Once the 0x00000000 state is reached, the timer reloads its start value from the concatenated **GPTMTAILR** on the next cycle. If configured to be a one-shot timer, the timer stops counting and clears the **TAEN** bit in the **GPTMCTL** register. If configured as a periodic timer, it continues counting.

In addition to reloading the count value, the GPTM generates interrupts and output triggers when it reaches the 0x00000000 state. The GPTM sets the **TATORIS** bit in the **GPTM Raw Interrupt Status (GPTMRIS)** register (see page 159), and holds it until it is cleared by writing the **GPTM Interrupt Clear (GPTMICR)** register (see page 161). If the time-out interrupt is enabled in the **GPTM Interrupt Mask (GPTIMR)** register (see page 157), the GPTM also sets the **TATOMIS** bit in the **GPTM Masked Interrupt Status (GPTMISR)** register (see page 160).

The output trigger is a one-clock-cycle pulse that is asserted when the counter hits the 0x00000000 state, and deasserted on the following clock cycle. It is enabled by setting the **TAOTE** bit in **GPTMCTL**, and can trigger SoC-level events such as ADC conversions.

If software reloads the **GPTMTAILR** register while the counter is running, the counter loads the new value on the next clock cycle and continues counting from the new value.

If the **TASTALL** bit in the **GPTMCTL** register is asserted, the timer freezes counting until the signal is deasserted.

### 9.2.2.2 32-Bit Real-Time Clock Timer Mode

In Real-Time Clock (RTC) mode, the concatenated versions of the TimerA and TimerB registers are configured as a 32-bit up-counter. When RTC mode is selected for the first time, the counter is loaded with a value of 0x00000001. All subsequent load values must be written to the **GPTM TimerA Match (GPTMTAMATCHR)** register (see page 164) by the controller.

The input clock on the CCP0 or CCP2 pins is required to be 32.768 KHz in RTC mode. The clock signal is then divided down to a 1 Hz rate and is passed along to the input of the 32-bit counter.

When software writes the **TAEN** bit in **GPTMCTL**, the counter starts counting up from its preloaded value of 0x00000001. When the current count value matches the preloaded value in **GPTMTAMATCHR**, it rolls over to a value of 0x00000000 and continues counting until either a hardware reset, or it is disabled by software (clearing the **TAEN** bit). When a match occurs, the GPTM asserts the **RTCRES** bit in **GPTMRIS**. If the RTC interrupt is enabled in **GPTIMR**, the GPTM also sets the **RTCMIS** bit in **GPTMISR** and generates a controller interrupt. The status flags are cleared by writing the **RTCCINT** bit in **GPTMICR**.

If the **TASTALL** and/or **TBSTALL** bits in the **GPTMCTL** register are set, the timer does not freeze if the **RTCEN** bit is set in **GPTMCTL**.

### 9.2.3 16-Bit Timer Operating Modes

The GPTM is placed into global 16-bit mode by writing a value of 0x4 to the **GPTM Configuration (GPTMCFG)** register (see page 152). This section describes each of the GPTM 16-bit modes of operation. Timer A and Timer B have identical modes, so a single description is given using an **n** to reference both.

#### 9.2.3.1 16-Bit One-Shot/Periodic Timer Mode

In 16-bit one-shot and periodic timer modes, the timer is configured as a 16-bit down-counter with an optional 8-bit prescaler that effectively extends the counting range of the timer to 24 bits. The selection of one-shot or periodic mode is determined by the value written to the **TnMR** field of the **GPTMTnMR** register. The optional prescaler is loaded into the **GPTM Timern Prescale (GPTMTnPR)** register.

When software writes the **TnEN** bit in the **GPTMCTL** register, the timer begins counting down from its preloaded value. Once the 0x0000 state is reached, the timer reloads its start value from **GPTMTnILR** and **GPTMTnPR** on the next cycle. If configured to be a one-shot timer, the timer stops counting and clears the **TnEN** bit in the **GPTMCTL** register. If configured as a periodic timer, it continues counting.

In addition to reloading the count value, the timer generates interrupts and output triggers when it reaches the 0x0000 state. The GPTM sets the **TnTORIS** bit in the **GPTMRIS** register, and holds it until it is cleared by writing the **GPTMICR** register. If the time-out interrupt is enabled in **GPTIMR**, the GPTM also sets the **TnTOMIS** bit in **GPTMISR** and generates a controller interrupt.

The output trigger is a one-clock-cycle pulse that is asserted when the counter hits the 0x0000 state, and deasserted on the following clock cycle. It is enabled by setting the **TnOTE** bit in the **GPTMCTL** register, and can trigger SoC-level events such as ADC conversions.

If software reloads the **GPTMTAILR** register while the counter is running, the counter loads the new value on the next clock cycle and continues counting from the new value.

If the **TnSTALL** bit in the **GPTMCTL** register is enabled, the timer freezes counting until the signal is deasserted.

The following example shows a variety of configurations for a 16-bit free running timer while using the prescaler. All values assume a 50-MHz clock with  $T_c=20$  ns (clock period).

Table 9-1. 16-Bit Timer With Prescaler Configurations

| Prescale | #Clock ( $T_C$ ) <sup>a</sup> | Max Time | Units |
|----------|-------------------------------|----------|-------|
| 00000000 | 1                             | 1.3107   | mS    |
| 00000001 | 2                             | 2.6214   | mS    |
| 00000010 | 3                             | 3.9321   | mS    |
| -----    | --                            |          |       |
| 11111100 | 254                           | 332.9229 | mS    |
| 11111110 | 255                           | 334.2336 | mS    |
| 11111111 | 256                           | 335.5443 | mS    |

a.  $T_C$  is the clock period.

### 9.2.3.2 16-Bit Input Edge Count Mode

In Edge Count mode, the timer is configured as a down-counter capable of capturing three types of events: rising edge, falling edge, or both. To place the timer in Edge Count mode, the  $T_nCMR$  bit of the **GPTMTnMR** register must be set to 0. The type of edge that the timer counts is determined by the  $T_nEVENT$  fields of the **GPTMCTL** register. During initialization, the **GPTM Timern Match (GPTMTnMATCHR)** register is configured so that the difference between the value in the **GPTMTnILR** register and the **GPTMTnMATCHR** register equals the number of edge events that must be counted.

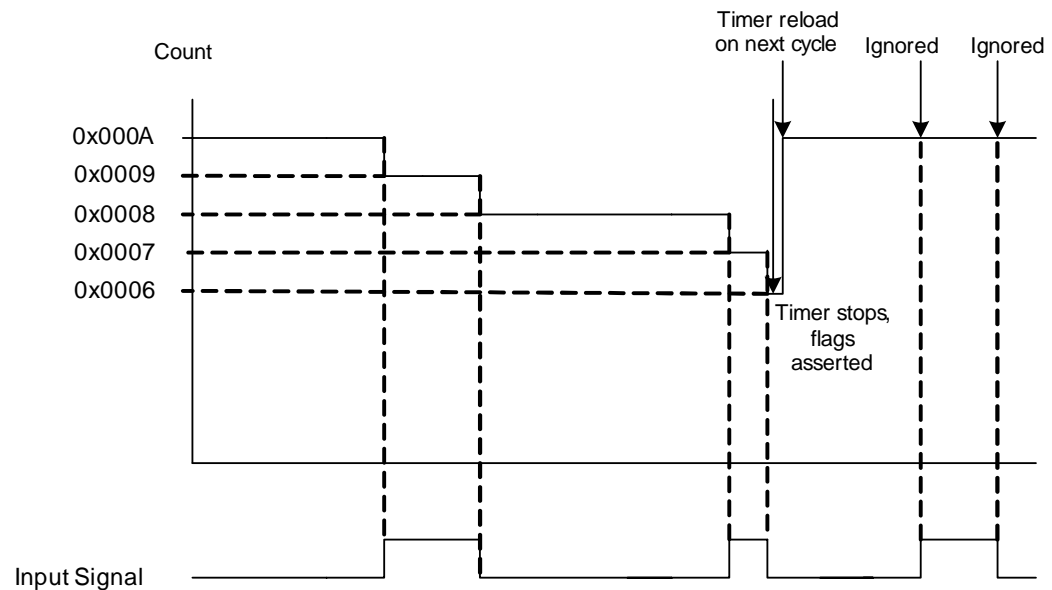
When software writes the  $T_nEN$  bit in the **GPTM Control (GPTMCTL)** register, the timer is enabled for event capture. Each input event on the  $CCP$  pin decrements the counter by 1 until the event count matches **GPTMTnMATCHR**. When the counts match, the GPTM asserts the  $C_nMRIS$  bit in the **GPTMRIS** register (and the  $C_nMMIS$  bit, if the interrupt is not masked). The counter is then reloaded using the value in **GPTMTnILR**, and stopped since the GPTM automatically clears the  $T_nEN$  bit in the **GPTMCTL** register. Once the event count has been reached, all further events are ignored until  $T_nEN$  is re-enabled by software.

Figure 9-2 shows how input edge count mode works. In this case, the timer start value is set to **GPTMTnILR=0x000A** and the match value is set to **GPTMTnMATCHR=0x0006** so that four edge events are counted. The counter is configured to detect both edges of the input signal.

Note that the last two edges are not counted since the timer automatically clears the  $T_nEN$  bit after the current count matches the value in the **GPTMTnMR** register.



Figure 9-2. 16-Bit Input Edge Count Mode Example



### 9.2.3.3 16-Bit Input Edge Time Mode

In Edge Time mode, the timer is configured as a free-running down-counter initialized to the value loaded in the **GPTMTnILR** register (or 0xFFFF at reset). This mode allows for event capture of both rising and falling edges. The timer is placed into Edge Time mode by setting the **TnCMR** bit in the **GPTMTnMR** register, and the type of event that the timer captures is determined by the **TnEVENT** fields of the **GPTMCTL** register.

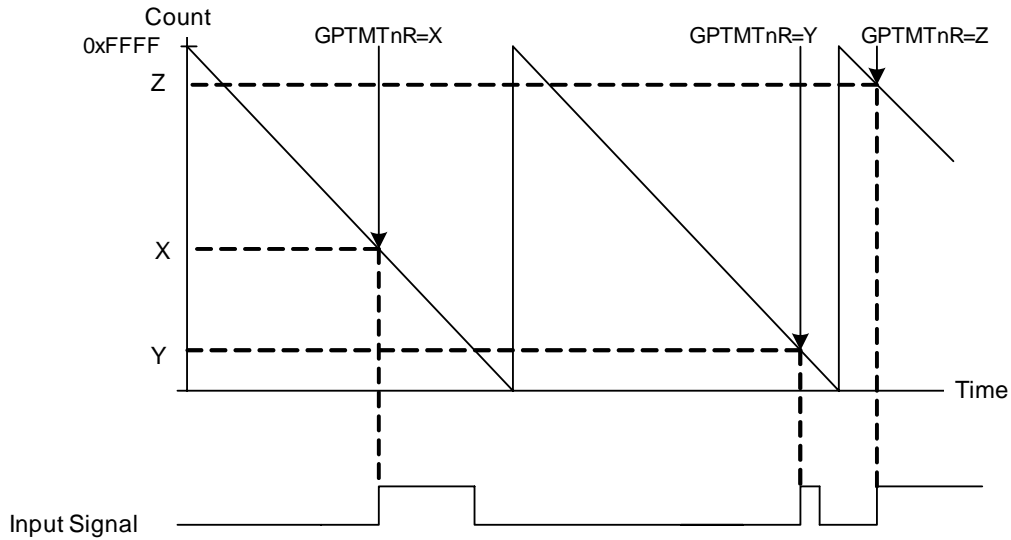
When software writes the **TnEN** bit in the **GPTMCTL** register, the timer is enabled for event capture. When the selected input event is detected, the current **Tn** counter value is captured in the **GPTMTnR** register and is available to be read by the controller. The GPTM then asserts the **CnERIS** bit (and the **CnEMIS** bit, if the interrupt is not masked).

After an event has been captured, the timer does not stop counting. It continues to count until the **TnEN** bit is cleared. When the timer reaches the 0x0000 state, it is reloaded with the value from the **GPTMnILR** register.

Figure 9-3 shows how input edge timing mode works. In the diagram, it is assumed that the start value of the timer is the default value of 0xFFFF, and the timer is configured to capture rising edge events.

Each time a rising edge event is detected, the current count value is loaded into the **GPTMTnR** register, and is held there until another rising edge is detected (at which point the new count value is loaded into **GPTMTnR**).

Figure 9-3. 16-Bit Input Edge Time Mode Example



9.2.3.4 16-Bit PWM Mode

The GPTM supports a simple PWM generation mode. In PWM mode, the timer is configured as a down-counter with a start value (and thus period) defined by **GPTMTnILR**. PWM mode is enabled with the **GPTMTnMR** register by setting the **TnAMS** bit to 0x1, the **TnCMR** bit to 0x0, and the **TnMR** field to 0x2.

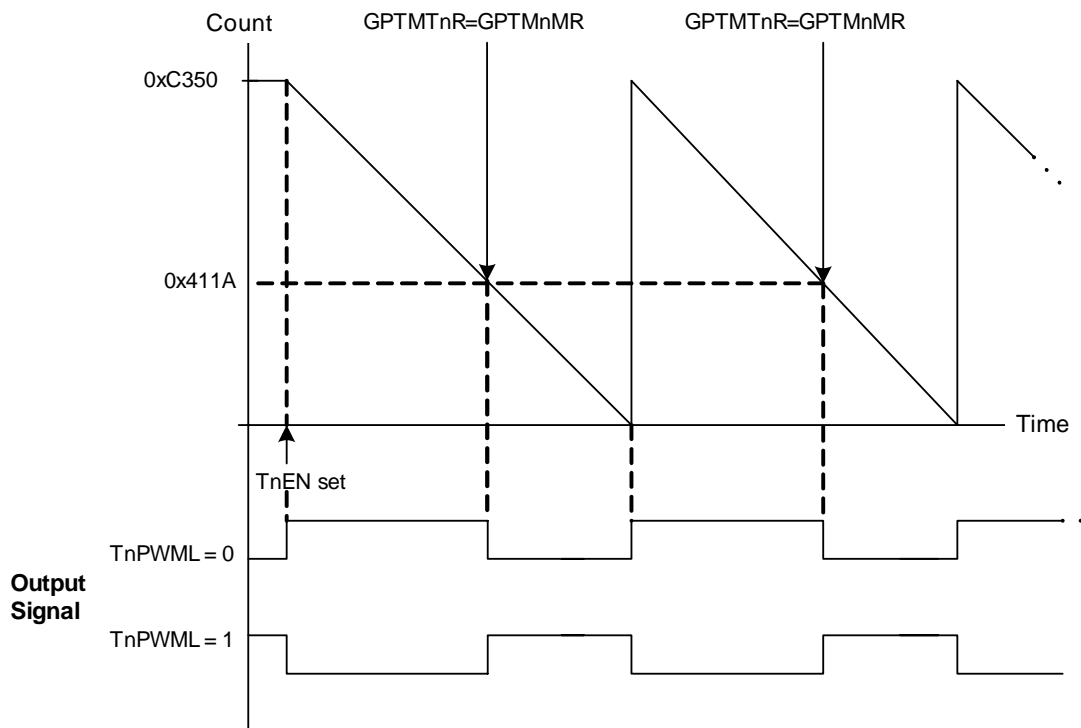
PWM mode can take advantage of the 8-bit prescaler by using the **GPTM Timern Prescale Register (GPTMTnPR)** and the **GPTM Timern Prescale Match Register (GPTMTnPMR)**. This effectively extends the range of the timer to 24 bits.

When software writes the **TnEN** bit in the **GPTMCTL** register, the counter begins counting down until it reaches the 0x0000 state. On the next counter cycle, the counter reloads its start value from **GPTMTnILR** (and **GPTMTnPR** if using a prescaler) and continues counting until disabled by software clearing the **TnEN** bit in the **GPTMCTL** register. No interrupts or status bits are asserted in PWM mode.

The output PWM signal asserts when the counter is at the value of the **GPTMTnILR** register (its start state), and is deasserted when the counter value equals the value in the **GPTM Timern Match Register (GPTMnMATCHR)**. Software has the capability of inverting the output PWM signal by setting the **TnPWML** bit in the **GPTMCTL** register.

Figure 9-4 shows how to generate an output PWM with a 1-ms period and a 66% duty cycle assuming a 50-MHz input clock and **TnPWML=0** (duty cycle would be 33% for the **TnPWML=1** configuration). For this example, the start value is **GPTMnIRL=0xC350** and the match value is **GPTMnMR=0x411A**.

Figure 9-4. 16-Bit PWM Mode Example



## 9.3 Initialization and Configuration

To use the general purpose timers, the peripheral clock must be enabled by setting the `GPTM0`, `GPTM1`, and `GPTM2` bits in the `RCGC1` register.

This section shows module initialization and configuration examples for each of the supported timer modes.

### 9.3.1 32-Bit One-Shot/Periodic Timer Mode

The GPTM is configured for 32-bit One-Shot and Periodic modes by the following sequence:

1. Ensure the timer is disabled (the `TAEN` bit in the `GPTMCTL` register is cleared) before making any changes.
2. Write the **GPTM Configuration Register (GPTMCFG)** with a value of 0x0.
3. Set the `TAMR` field in the **GPTM TimerA Mode Register (GPTMTAMR)**:
  - a. Write a value of 0x1 for One-Shot mode.
  - b. Write a value of 0x2 for Periodic mode.
4. Load the start value into the **GPTM TimerA Interval Load Register (GPTMTAILR)**.
5. If interrupts are required, set the `TATOIM` bit in the **GPTM Interrupt Mask Register (GPTMIMR)**.
6. Set the `TAEN` bit in the `GPTMCTL` register to enable the timer and start counting.
7. Poll the `TATORIS` bit in the `GPTMRIS` register or wait for the interrupt to be generated (if enabled). In both cases, the status flags are cleared by writing a 1 to the `TATOCINT` bit of the **GPTM Interrupt Clear Register (GPTMICR)**.

In One-Shot mode, the timer stops counting after step 7. To re-enable the timer, repeat the sequence. A timer configured in Periodic mode does not stop counting after it times out.

### 9.3.2 32-Bit Real-Time Clock (RTC) Mode

To use the RTC mode, the timer must have a 32.768-KHz input signal on its CCP0 or CCP2 pins. To enable the RTC feature, follow these steps:

1. Ensure the timer is disabled (the **TAEN** bit is cleared) before making any changes.
2. Write the **GPTM Configuration Register (GPTMCFG)** with a value of 0x1.
3. Write the desired match value to the **GPTM TimerA Match Register (GPTMTAMATCHR)**.
4. Set/clear the **RTCEN** bit in the **GPTM Control Register (GPTMCTL)** as desired.
5. If interrupts are required, set the **RTCIM** bit in the **GPTM Interrupt Mask Register (GPTMIMR)**.
6. Set the **TAEN** bit in the **GPTMCTL** register to enable the timer and start counting.

When the timer count equals the value in the **GPTMTAMATCHR** register, the counter is re-loaded with 0x00000000 and begins counting. If an interrupt is enabled, it does not have to be cleared.

### 9.3.3 16-Bit One-Shot/Periodic Timer Mode

A timer is configured for 16-bit One-Shot and Periodic modes by the following sequence:

1. Ensure the timer is disabled (the **TnEN** bit is cleared) before making any changes.
2. Write the **GPTM Configuration Register (GPTMCFG)** with a value of 0x4.
3. Set the **TnMR** field in the **GPTM Timer Mode (GPTMTnMR)** register:
  - a. Write a value of 0x1 for One-Shot mode.
  - b. Write a value of 0x2 for Periodic mode.
4. If a prescaler is to be used, write the prescale value to the **GPTM Timern Prescale Register (GPTMTnPR)**.
5. Load the start value into the **GPTM Timer Interval Load Register (GPTMTnILR)**.
6. If interrupts are required, set the **TnTOIM** bit in the **GPTM Interrupt Mask Register (GPTMIMR)**.
7. Set the **TnEN** bit in the **GPTM Control Register (GPTMCTL)** to enable the timer and start counting.
8. Poll the **TnTORIS** bit in the **GPTMRIS** register or wait for the interrupt to be generated (if enabled). In both cases, the status flags are cleared by writing a 1 to the **TnTOCINT** bit of the **GPTM Interrupt Clear Register (GPTMICR)**.

In One-Shot mode, the timer stops counting after step 8. To re-enable the timer, repeat the sequence. A timer configured in Periodic mode does not stop counting after it times out.

### 9.3.4 16-Bit Input Edge Count Mode

A timer is configured to Input Edge Count mode by the following sequence:

1. Ensure the timer is disabled (the **TnEN** bit is cleared) before making any changes.
2. Write the **GPTM Configuration (GPTMCFG)** register with a value of 0x4.
3. In the **GPTM Timer Mode (GPTMTnMR)** register, write the **TnCMR** field to 0x0 and the **TnMR** field to 0x3.

4. Configure the type of event(s) that the timer captures by writing the `TnEVENT` field of the **GPTM Control (GPTMCTL)** register.
5. Load the timer start value into the **GPTM Timern Interval Load (GPTMTnILR)** register.
6. Load the desired event count into the **GPTM Timern Match (GPTMTnMATCHR)** register.
7. If interrupts are required, set the `CnMIM` bit in the **GPTM Interrupt Mask (GPTMIMR)** register.
8. Set the `TnEN` bit in the **GPTMCTL** register to enable the timer and begin waiting for edge events.
9. Poll the `CnMRIS` bit in the **GPTMRIS** register or wait for the interrupt to be generated (if enabled). In both cases, the status flags are cleared by writing a 1 to the `CnMCINT` bit of the **GPTM Interrupt Clear (GPTMICR)** register.

In Input Edge Count Mode, the timer stops after the desired number of edge events has been detected. To re-enable the timer, ensure that the `TnEN` bit is cleared and repeat steps 4-9.

### 9.3.5 16-Bit Input Edge Timing Mode

A timer is configured to Input Edge Timing mode by the following sequence:

1. Ensure the timer is disabled (the `TnEN` bit is cleared) before making any changes.
2. Write the **GPTM Configuration (GPTMCFG)** register with a value of 0x4.
3. In the **GPTM Timer Mode (GPTMTnMR)** register, write the `TnCMR` field to 0x1 and the `TnMR` field to 0x3.
4. Configure the type of event that the timer captures by writing the `TnEVENT` field of the **GPTM Control (GPTMCTL)** register.
5. Load the timer start value into the **GPTM Timern Interval Load (GPTMTnILR)** register.
6. If interrupts are required, set the `CnEIM` bit in the **GPTM Interrupt Mask (GPTMIMR)** register.
7. Set the `TnEN` bit in the **GPTM Control (GPTMCTL)** register to enable the timer and start counting.
8. Poll the `CnERIS` bit in the **GPTMRIS** register or wait for the interrupt to be generated (if enabled). In both cases, the status flags are cleared by writing a 1 to the `CnECINT` bit of the **GPTM Interrupt Clear (GPTMICR)** register. The time at which the event happened can be obtained by reading the **GPTM Timern (GPTMTnR)** register.

In Input Edge Timing mode, the timer continues running after an edge event has been detected, but the timer interval can be changed at any time by writing the **GPTMTnILR** register. The change takes effect at the next cycle after the write.

### 9.3.6 16-Bit PWM Mode

A timer is configured to PWM mode using the following sequence:

1. Ensure the timer is disabled (the `TnEN` bit is cleared) before making any changes.
2. Write the **GPTM Configuration (GPTMCFG)** register with a value of 0x4.
3. In the **GPTM Timer Mode (GPTMTnMR)** register, set the `TnAMS` bit to 0x1, the `TnCMR` bit to 0x0, and the `TnMR` field to 0x2.
4. Configure the output state of the PWM signal (whether or not it is inverted) in the `TnEVENT` field of the **GPTM Control (GPTMCTL)** register.
5. Load the timer start value into the **GPTM Timern Interval Load (GPTMTnILR)** register.
6. Load the **GPTM Timern Match (GPTMTnMATCHR)** register with the desired value.

7. If a prescaler is going to be used, configure the **GPTM Timern Prescale (GPTMTnPR)** register and the **GPTM Timern Prescale Match (GPTMTnPMR)** register.
8. Set the **TnEN** bit in the **GPTM Control (GPTMCTL)** register to enable the timer and begin generation of the output PWM signal.

In PWM Timing mode, the timer continues running after the PWM signal has been generated. The PWM period can be adjusted at any time by writing the **GPTMTnILR** register, and the change takes effect at the next cycle after the write.

## 9.4 Register Map

Table 9-1 lists the GPTM registers. The offset listed is a hexadecimal increment to the register's address, relative to that timer's base address:

- Timer0: 0x40030000
- Timer1: 0x40031000
- Timer2: 0x40032000

**Table 9-2. GPTM Register Map**

| Offset | Name         | Reset                                 | Type | Description             | See page |
|--------|--------------|---------------------------------------|------|-------------------------|----------|
| 0x000  | GPTMCFG      | 0x00000000                            | R/W  | Configuration           | 152      |
| 0x004  | GPTMTAMR     | 0x00000000                            | R/W  | TimerA mode             | 153      |
| 0x008  | GPTMTBMR     | 0x00000000                            | R/W  | TimerB mode             | 154      |
| 0x00C  | GPTMCTL      | 0x00000000                            | R/W  | Control                 | 155      |
| 0x018  | GPTMIMR      | 0x00000000                            | R/W  | Interrupt mask          | 157      |
| 0x01C  | GPTMRIS      | 0x00000000                            | RO   | Interrupt status        | 159      |
| 0x020  | GPTMMIS      | 0x00000000                            | RO   | Masked interrupt status | 160      |
| 0x024  | GPTMICR      | 0x00000000                            | W1C  | Interrupt clear         | 161      |
| 0x028  | GPTMTAILR    | 0x0000FFFF <sup>a</sup><br>0xFFFFFFFF | R/W  | TimerA interval load    | 162      |
| 0x02C  | GPTMTBILR    | 0x0000FFFF                            | R/W  | TimerB interval load    | 163      |
| 0x030  | GPTMTAMATCHR | 0x0000FFFF <sup>a</sup><br>0xFFFFFFFF | R/W  | TimerA match            | 164      |
| 0x034  | GPTMTBMATCHR | 0x0000FFFF                            | R/W  | TimerB match            | 165      |
| 0x038  | GPTMTAPR     | 0x00000000                            | R/W  | TimerA prescale         | 166      |
| 0x03C  | GPTMTBPR     | 0x00000000                            | R/W  | TimerB prescale         | 167      |
| 0x040  | GPTMTAPMR    | 0x00000000                            | R/W  | TimerA prescale match   | 168      |
| 0x044  | GPTMTBPMR    | 0x00000000                            | R/W  | TimerB prescale match   | 169      |

Table 9-2. GPTM Register Map (Continued)

| Offset | Name    | Reset                                 | Type | Description | See page |
|--------|---------|---------------------------------------|------|-------------|----------|
| 0x048  | GPTMTAR | 0x0000FFFF <sup>a</sup><br>0xFFFFFFFF | RO   | TimerA      | 170      |
| 0x04C  | GPTMTBR | 0x0000FFFF                            | RO   | TimerB      | 171      |

a. The default reset value for the **GPTMTAILR**, **GPTMTAMATCHR**, and **GPTMTAR** registers is 0x0000FFFF when in 16-bit mode and 0xFFFFFFFF when in 32-bit mode.

## 9.5 Register Descriptions

The remainder of this section lists and describes the GPTM registers, in numerical order by address offset.

**Register 1: GPTM Configuration (GPTMCFG), offset 0x000**

This register configures the global operation of the GPTM module. The value written to this register determines whether the GPTM is in 32- or 16-bit mode.

GPTM Configuration (GPTMCFG)

Offset 0x000

|       |          |    |    |    |    |    |    |    |    |    |    |    |    |         |     |     |
|-------|----------|----|----|----|----|----|----|----|----|----|----|----|----|---------|-----|-----|
|       | 31       | 30 | 29 | 28 | 27 | 26 | 25 | 24 | 23 | 22 | 21 | 20 | 19 | 18      | 17  | 16  |
|       | reserved |    |    |    |    |    |    |    |    |    |    |    |    |         |     |     |
| Type  | RO       | RO | RO | RO | RO | RO | RO | RO | RO | RO | RO | RO | RO | RO      | RO  | RO  |
| Reset | 0        | 0  | 0  | 0  | 0  | 0  | 0  | 0  | 0  | 0  | 0  | 0  | 0  | 0       | 0   | 0   |
|       | 15       | 14 | 13 | 12 | 11 | 10 | 9  | 8  | 7  | 6  | 5  | 4  | 3  | 2       | 1   | 0   |
|       | reserved |    |    |    |    |    |    |    |    |    |    |    |    | GPTMCFG |     |     |
| Type  | RO       | RO | RO | RO | RO | RO | RO | RO | RO | RO | RO | RO | RO | R/W     | R/W | R/W |
| Reset | 0        | 0  | 0  | 0  | 0  | 0  | 0  | 0  | 0  | 0  | 0  | 0  | 0  | 0       | 0   | 0   |

| Bit/Field | Name     | Type | Reset | Description  |
|-----------|----------|------|-------|--|
| 31:3      | reserved | RO   | 0     | Reserved bits return an indeterminate value, and should never be changed.  |
| 2:0       | GPTMCFG  | R/W  | 0     | GPTM Configuration<br>0x0: 32-bit timer configuration.<br>0x1: 32-bit real-time clock (RTC) counter configuration.<br>0x2: Reserved.<br>0x3: Reserved.<br>0x4-0x7: 16-bit timer configuration, function is controlled by bits 1:0 of <b>GPTMTAMR</b> and <b>GPTMTBMR</b> . |



**Register 2: GPTM TimerA Mode (GPTMTAMR), offset 0x004**

This register configures the GPTM based on the configuration selected in the **GPTMCFG** register. When in 16-bit PWM mode, set the **TAAMS** bit to 0x1, the **TACMR** bit to 0x0, and the **TAMR** field to 0x2.

GPTM TimerA Mode (GPTMTAMR)

Offset 0x004

|       |          |    |    |    |    |    |    |    |    |    |    |    |       |       |      |     |
|-------|----------|----|----|----|----|----|----|----|----|----|----|----|-------|-------|------|-----|
|       | 31       | 30 | 29 | 28 | 27 | 26 | 25 | 24 | 23 | 22 | 21 | 20 | 19    | 18    | 17   | 16  |
|       | reserved |    |    |    |    |    |    |    |    |    |    |    |       |       |      |     |
| Type  | RO       | RO | RO | RO | RO | RO | RO | RO | RO | RO | RO | RO | RO    | RO    | RO   | RO  |
| Reset | 0        | 0  | 0  | 0  | 0  | 0  | 0  | 0  | 0  | 0  | 0  | 0  | 0     | 0     | 0    | 0   |
|       | 15       | 14 | 13 | 12 | 11 | 10 | 9  | 8  | 7  | 6  | 5  | 4  | 3     | 2     | 1    | 0   |
|       | reserved |    |    |    |    |    |    |    |    |    |    |    | TAAMS | TACMR | TAMR |     |
| Type  | RO       | RO | RO | RO | RO | RO | RO | RO | RO | RO | RO | RO | R/W   | R/W   | R/W  | R/W |
| Reset | 0        | 0  | 0  | 0  | 0  | 0  | 0  | 0  | 0  | 0  | 0  | 0  | 0     | 0     | 0    | 0   |

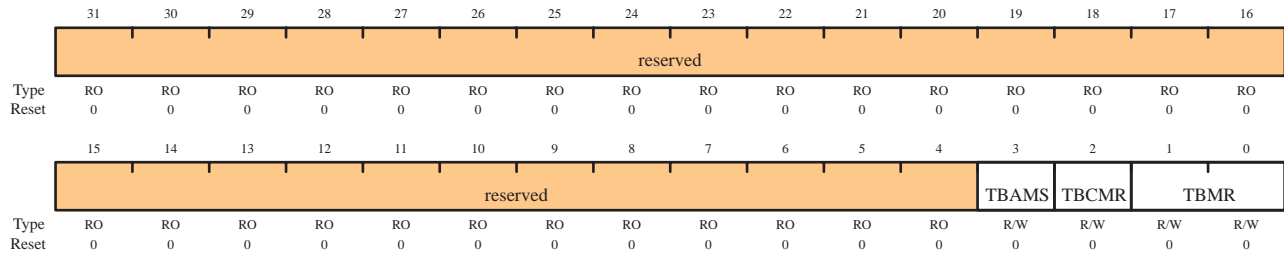
| Bit/Field | Name     | Type | Reset | Description  |
|-----------|----------|------|-------|--|
| 31:4      | reserved | RO   | 0     | Reserved bits return an indeterminate value, and should never be changed.  |
| 3         | TAAMS    | R/W  | 0     | GPTM TimerA Alternate Mode Select<br>0: Capture mode is enabled.<br>1: PWM mode is enabled.<br><b>Note:</b> To enable PWM mode, you must also clear the <b>TACMR</b> bit and set the <b>TAMR</b> field to 0x2.   |
| 2         | TACMR    | R/W  | 0     | GPTM TimerA Capture Mode<br>0: Edge-Count mode.<br>1: Edge-Time mode.  |
| 1:0       | TAMR     | R/W  | 0     | GPTM TimerA Mode<br>0x0: Reserved.<br>0x1: One-Shot Timer mode.<br>0x2: Periodic Timer mode.<br>0x3: Capture mode.<br><br>The Timer mode is based on the timer configuration defined by bits 2:0 in the <b>GPTMCFG</b> register (16-or 32-bit).<br>In 16-bit timer configuration, <b>TAMR</b> controls the 16-bit timer modes for TimerA.<br><br>In 32-bit timer configuration, this register controls the mode and the contents of <b>GPTMTBMR</b> are ignored. |

**Register 3: GPTM TimerB Mode (GPTMTBMR), offset 0x008**

This register configures the GPTM based on the configuration selected in the **GPTMCFG** register. When in 16-bit PWM mode, set the **TBAMS** bit to 0x1, the **TBCMR** bit to 0x0, and the **TBMR** field to 0x2.

GPTM TimerB Mode (GPTMTBMR)

Offset 0x008



| Bit/Field | Name     | Type | Reset | Description  |
|-----------|----------|------|-------|--|
| 31:4      | reserved | RO   | 0     | Reserved bits return an indeterminate value, and should never be changed.  |
| 3         | TBAMS    | R/W  | 0     | GPTM TimerB Alternate Mode Select<br>0: Capture mode is enabled.<br>1: PWM mode is enabled.<br><b>Note:</b> To enable PWM mode, you must also clear the <b>TBCMR</b> bit and set the <b>TBMR</b> field to 0x2.   |
| 2         | TBCMR    | R/W  | 0     | GPTM TimerB Capture Mode<br>0: Edge-Count mode.<br>1: Edge-Time mode.  |
| 1:0       | TBMR     | R/W  | 0     | GPTM TimerB Mode<br>0x0: Reserved.<br>0x1: One-Shot Timer mode.<br>0x2: Periodic Timer mode.<br>0x3: Capture mode.<br>The timer mode is based on the timer configuration defined by bits 2:0 in the <b>GPTMCFG</b> register.<br>In 16-bit timer configuration, these bits control the 16-bit timer modes for TimerB.<br>In 32-bit timer configuration, this register's contents are ignored and <b>GPTMTAMR</b> is used. |

**Register 4: GPTM Control (GPTMCTL), offset 0x00C**

This register is used alongside the **GPTMCFG** and **GMTMTnMR** registers to fine-tune the timer configuration, and to enable other features such as timer stall and the output trigger. The output trigger can be used to initiate transfers on the ADC module.

## GPTM Control (GPTMCTL)

Offset 0x00C

|       |          |        |       |     |         |         |      |     |        |       |       |         |         |      |     |     |
|-------|----------|--------|-------|-----|---------|---------|------|-----|--------|-------|-------|---------|---------|------|-----|-----|
|       | 31       | 30     | 29    | 28  | 27      | 26      | 25   | 24  | 23     | 22    | 21    | 20      | 19      | 18   | 17  | 16  |
|       | reserved |        |       |     |         |         |      |     |        |       |       |         |         |      |     |     |
| Type  | RO       | RO     | RO    | RO  | RO      | RO      | RO   | RO  | RO     | RO    | RO    | RO      | RO      | RO   | RO  | RO  |
| Reset | 0        | 0      | 0     | 0   | 0       | 0       | 0    | 0   | 0      | 0     | 0     | 0       | 0       | 0    | 0   | 0   |
|       | 15       | 14     | 13    | 12  | 11      | 10      | 9    | 8   | 7      | 6     | 5     | 4       | 3       | 2    | 1   | 0   |
|       | res      | TBPWML | TBOTE | res | TBEVENT | TBSTALL | TBEN | res | TAPWML | TAOTE | RTCEN | TAEVENT | TASTALL | TAEN |     |     |
| Type  | RO       | R/W    | R/W   | RO  | R/W     | R/W     | R/W  | R/W | RO     | R/W   | R/W   | R/W     | R/W     | R/W  | R/W | R/W |
| Reset | 0        | 0      | 0     | 0   | 0       | 0       | 0    | 0   | 0      | 0     | 0     | 0       | 0       | 0    | 0   | 0   |

| Bit/Field | Name     | Type | Reset | Description  |
|-----------|----------|------|-------|--|
| 31:15     | reserved | RO   | 0     | Reserved bits return an indeterminate value, and should never be changed.  |
| 14        | TBPWML   | R/W  | 0     | GPTM TimerB PWM Output Level<br>0: Output is unaffected.<br>1: Output is inverted.   |
| 13        | TBOTE    | R/W  | 0     | GPTM TimerB Output Trigger Enable<br>0: The output TimerB trigger is disabled.<br>1: The output TimerB trigger is enabled.                                     |
| 12        | reserved | RO   | 0     | Reserved bits return an indeterminate value, and should never be changed.  |
| 11:10     | TBEVENT  | R/W  | 0     | GPTM TimerB Event Mode<br>00: Positive edge.<br>01: Negative edge.<br>10: Reserved.<br>11: Both edges.   |
| 9         | TBSTALL  | R/W  | 0     | GPTM TimerB Stall Enable<br>0: TimerB stalling is disabled.<br>1: TimerB stalling is enabled.  |
| 8         | TBEN     | R/W  | 0     | GPTM TimerB Enable<br>0: TimerB is disabled.<br>1: TimerB is enabled and begins counting or the capture logic is enabled based on the <b>GPTMCFG</b> register. |
| 7         | reserved | RO   | 0     | Reserved bits return an indeterminate value, and should never be changed.  |

## General-Purpose Timers

---

| Bit/Field | Name    | Type | Reset | Description  |
|-----------|---------|------|-------|--|
| 6         | TAPWML  | R/W  | 0     | GPTM TimerA PWM Output Level<br>0: Output is unaffected.<br>1: Output is inverted.   |
| 5         | TAOTE   | R/W  | 0     | GPTM TimerA Output Trigger Enable<br>0: The output TimerA trigger is disabled.<br>1: The output TimerA trigger is enabled.                                     |
| 4         | RTCEN   | R/W  | 0     | GPTM RTC Enable<br>0: RTC counting is disabled.<br>1: RTC counting is enabled.   |
| 3:2       | TAEVENT | R/W  | 0     | GPTM TimerA Event Mode<br>00: Positive edge.<br>01: Negative edge.<br>10: Reserved.<br>11: Both edges.   |
| 1         | TASTALL | R/W  | 0     | GPTM TimerA Stall Enable<br>0: TimerA stalling is disabled.<br>1: TimerA stalling is enabled.  |
| 0         | TAEN    | R/W  | 0     | GPTM TimerA Enable<br>0: TimerA is disabled.<br>1: TimerA is enabled and begins counting or the capture logic is enabled based on the <b>GPTMCFG</b> register. |

**Register 5: GPTM Interrupt Mask (GPTMIMR), offset 0x018**

This register allows software to enable/disable GPTM controller-level interrupts. Writing a 1 enables the interrupt, while writing a 0 disables it.

## GPTM Interrupt Mask (GPTMIMR)

Offset 0x018

|       |          |    |    |    |    |       |       |        |          |    |    |    |       |       |       |        |
|-------|----------|----|----|----|----|-------|-------|--------|----------|----|----|----|-------|-------|-------|--------|
|       | 31       | 30 | 29 | 28 | 27 | 26    | 25    | 24     | 23       | 22 | 21 | 20 | 19    | 18    | 17    | 16     |
|       | reserved |    |    |    |    |       |       |        |          |    |    |    |       |       |       |        |
| Type  | RO       | RO | RO | RO | RO | RO    | RO    | RO     | RO       | RO | RO | RO | RO    | RO    | RO    | RO     |
| Reset | 0        | 0  | 0  | 0  | 0  | 0     | 0     | 0      | 0        | 0  | 0  | 0  | 0     | 0     | 0     | 0      |
|       | 15       | 14 | 13 | 12 | 11 | 10    | 9     | 8      | 7        | 6  | 5  | 4  | 3     | 2     | 1     | 0      |
|       | reserved |    |    |    |    | CBEIM | CBMIM | TBTOIM | reserved |    |    |    | RTCIM | CAEIM | CAMIM | TATOIM |
| Type  | RO       | RO | RO | RO | RO | R/W   | R/W   | R/W    | RO       | RO | RO | RO | R/W   | R/W   | R/W   | R/W    |
| Reset | 0        | 0  | 0  | 0  | 0  | 0     | 0     | 0      | 0        | 0  | 0  | 0  | 0     | 0     | 0     | 0      |

| Bit/Field | Name     | Type | Reset | Description  |
|-----------|----------|------|-------|--|
| 31:11     | reserved | RO   | 0     | Reserved bits return an indeterminate value, and should never be changed.                    |
| 10        | CBEIM    | R/W  | 0     | GPTM CaptureB Event Interrupt Mask<br>0: Interrupt is disabled.<br>1: Interrupt is enabled.  |
| 9         | CBMIM    | R/W  | 0     | GPTM CaptureB Match Interrupt Mask<br>0: Interrupt is disabled.<br>1: Interrupt is enabled.  |
| 8         | TBTOIM   | R/W  | 0     | GPTM TimerB Time-Out Interrupt Mask<br>0: Interrupt is disabled.<br>1: Interrupt is enabled. |
| 7:4       | reserved | RO   | 0     | Reserved bits return an indeterminate value, and should never be changed.                    |
| 3         | RTCIM    | R/W  | 0     | GPTM RTC Interrupt Mask<br>0: Interrupt is disabled.<br>1: Interrupt is enabled.             |
| 2         | CAEIM    | R/W  | 0     | GPTM CaptureA Event Interrupt Mask<br>0: Interrupt is disabled.<br>1: Interrupt is enabled.  |

## General-Purpose Timers

---

| Bit/Field | Name   | Type | Reset | Description  |
|-----------|--------|------|-------|--|
| 1         | CAMIM  | R/W  | 0     | GPTM CaptureA Match Interrupt Mask<br>0: Interrupt is disabled.<br>1: Interrupt is enabled.  |
| 0         | TATOIM | R/W  | 0     | GPTM TimerA Time-Out Interrupt Mask<br>0: Interrupt is disabled.<br>1: Interrupt is enabled. |

**Register 6: GPTM Raw Interrupt Status (GPTMRIS), offset 0x01C**

This register shows the state of the GPTM's internal interrupt signal. These bits are set whether or not the interrupt is masked in the **GPTMIMR** register. Each bit can be cleared by writing a 1 to its corresponding bit in **GPTMICR**.

## GPTM Raw Interrupt Status (GPTMRIS)

Offset 0x01C

|       |          |    |    |    |    |        |        |         |          |    |    |    |    |        |        |        |         |
|-------|----------|----|----|----|----|--------|--------|---------|----------|----|----|----|----|--------|--------|--------|---------|
|       | 31       | 30 | 29 | 28 | 27 | 26     | 25     | 24      | 23       | 22 | 21 | 20 | 19 | 18     | 17     | 16     |         |
|       | reserved |    |    |    |    |        |        |         |          |    |    |    |    |        |        |        |         |
| Type  | RO       | RO | RO | RO | RO | RO     | RO     | RO      | RO       | RO | RO | RO | RO | RO     | RO     | RO     |         |
| Reset | 0        | 0  | 0  | 0  | 0  | 0      | 0      | 0       | 0        | 0  | 0  | 0  | 0  | 0      | 0      | 0      |         |
|       | 15       | 14 | 13 | 12 | 11 | 10     | 9      | 8       | 7        | 6  | 5  | 4  | 3  | 2      | 1      | 0      |         |
|       | reserved |    |    |    |    | CBERIS | CBMRIS | TBTORIS | reserved |    |    |    |    | RTCRIS | CAERIS | CAMRIS | TATORIS |
| Type  | RO       | RO | RO | RO | RO | RO     | RO     | RO      | RO       | RO | RO | RO | RO | RO     | RO     | RO     |         |
| Reset | 0        | 0  | 0  | 0  | 0  | 0      | 0      | 0       | 0        | 0  | 0  | 0  | 0  | 0      | 0      | 0      |         |

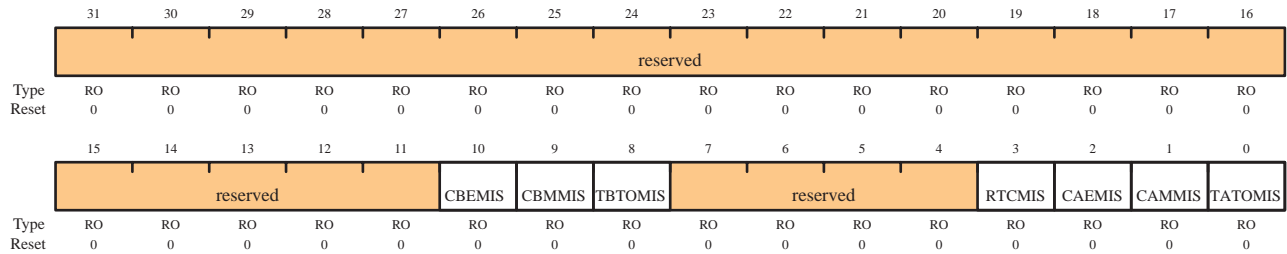
| Bit/Field | Name     | Type | Reset | Description  |
|-----------|----------|------|-------|--|
| 31:11     | reserved | RO   | 0     | Reserved bits return an indeterminate value, and should never be changed.                            |
| 10        | CBERIS   | RO   | 0     | GPTM CaptureB Event Raw Interrupt<br>This is the CaptureB Event interrupt status prior to masking.   |
| 9         | CBMRIS   | RO   | 0     | GPTM CaptureB Match Raw Interrupt<br>This is the CaptureB Match interrupt status prior to masking.   |
| 8         | TBTORIS  | RO   | 0     | GPTM TimerB Time-Out Raw Interrupt<br>This is the TimerB time-out interrupt status prior to masking. |
| 7:4       | reserved | RO   | 0     | Reserved bits return an indeterminate value, and should never be changed.                            |
| 3         | RTCRIS   | RO   | 0     | GPTM RTC Raw Interrupt<br>This is the RTC Event interrupt status prior to masking.                   |
| 2         | CAERIS   | RO   | 0     | GPTM CaptureA Event Raw Interrupt<br>This is the CaptureA Event interrupt status prior to masking.   |
| 1         | CAMRIS   | RO   | 0     | GPTM CaptureA Match Raw Interrupt<br>This is the CaptureA Match interrupt status prior to masking.   |
| 0         | TATORIS  | RO   | 0     | GPTM TimerA Time-Out Raw Interrupt<br>This the TimerA time-out interrupt status prior to masking.    |

**Register 7: GPTM Masked Interrupt Status (GPTMMIS), offset 0x020**

This register show the state of the GPTM's controller-level interrupt. If an interrupt is unmasked in **GPTMIMR**, and there is an event that causes the interrupt to be asserted, the corresponding bit is set in this register. All bits are cleared by writing a 1 to the corresponding bit in **GPTMICR**.

GPTM Masked Interrupt Status (GPTMMIS)

Offset 0x020



| Bit/Field | Name     | Type | Reset | Description  |
|-----------|----------|------|-------|--|
| 31:11     | reserved | RO   | 0     | Reserved bits return an indeterminate value, and should never be changed.                            |
| 10        | CBEMIS   | RO   | 0     | GPTM CaptureB Event Masked Interrupt<br>This is the CaptureB event interrupt status after masking.   |
| 9         | CBMMIS   | RO   | 0     | GPTM CaptureB Match Masked Interrupt<br>This is the CaptureB match interrupt status after masking.   |
| 8         | TBTOMIS  | RO   | 0     | GPTM TimerB Time-Out Masked Interrupt<br>This is the TimerB time-out interrupt status after masking. |
| 7:4       | reserved | RO   | 0     | Reserved bits return an indeterminate value, and should never be changed.                            |
| 3         | RTCMIS   | RO   | 0     | GPTM RTC Masked Interrupt<br>This is the RTC event interrupt status after masking.                   |
| 2         | CAEMIS   | RO   | 0     | GPTM CaptureA Event Masked Interrupt<br>This is the CaptureA event interrupt status after masking.   |
| 1         | CAMMIS   | RO   | 0     | GPTM CaptureA Match Masked Interrupt<br>This is the CaptureA match interrupt status after masking.   |
| 0         | TATOMIS  | RO   | 0     | GPTM TimerA Time-Out Masked Interrupt<br>This is the TimerA time-out interrupt status after masking. |



**Register 8: GPTM Interrupt Clear (GPTMICR), offset 0x024**

This register is used to clear the status bits in the **GPTMRIS** and **GPTMMIS** registers. Writing a 1 to a bit clears the corresponding bit in the **GPTMRIS** and **GPTMMIS** registers.

## GPTM Interrupt Clear (GPTMICR)

Offset 0x024

|       |          |    |    |    |         |         |          |          |    |    |    |         |         |         |          |     |
|-------|----------|----|----|----|---------|---------|----------|----------|----|----|----|---------|---------|---------|----------|-----|
|       | 31       | 30 | 29 | 28 | 27      | 26      | 25       | 24       | 23 | 22 | 21 | 20      | 19      | 18      | 17       | 16  |
|       | reserved |    |    |    |         |         |          |          |    |    |    |         |         |         |          |     |
| Type  | RO       | RO | RO | RO | RO      | RO      | RO       | RO       | RO | RO | RO | RO      | RO      | RO      | RO       | RO  |
| Reset | 0        | 0  | 0  | 0  | 0       | 0       | 0        | 0        | 0  | 0  | 0  | 0       | 0       | 0       | 0        | 0   |
|       | 15       | 14 | 13 | 12 | 11      | 10      | 9        | 8        | 7  | 6  | 5  | 4       | 3       | 2       | 1        | 0   |
|       | reserved |    |    |    | CBECINT | CBMCINT | TBTOCINT | reserved |    |    |    | RTCCINT | CAECINT | CAMCINT | TATOCINT |     |
| Type  | RO       | RO | RO | RO | W1C     | W1C     | W1C      | W1C      | RO | RO | RO | RO      | W1C     | W1C     | W1C      | W1C |
| Reset | 0        | 0  | 0  | 0  | 0       | 0       | 0        | 0        | 0  | 0  | 0  | 0       | 0       | 0       | 0        | 0   |

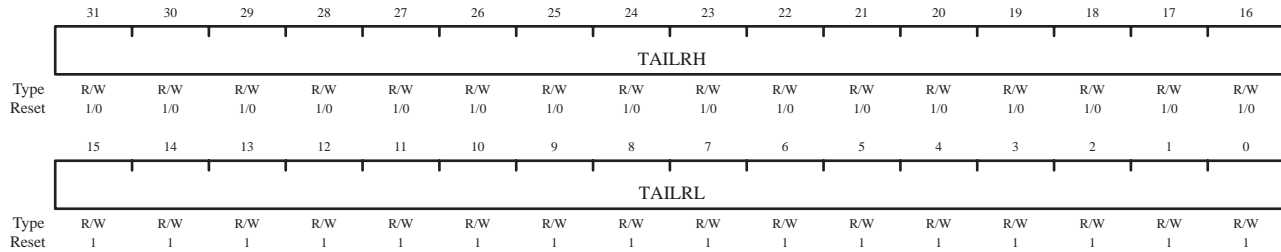
| Bit/Field | Name     | Type | Reset | Description   |
|-----------|----------|------|-------|---|
| 31:11     | reserved | RO   | 0     | Reserved bits return an indeterminate value, and should never be changed.                               |
| 10        | CBECINT  | W1C  | 0     | GPTM CaptureB Event Interrupt Clear<br>0: The interrupt is unaffected.<br>1: The interrupt is cleared.  |
| 9         | CBMCINT  | W1C  | 0     | GPTM CaptureB Match Interrupt Clear<br>0: The interrupt is unaffected.<br>1: The interrupt is cleared.  |
| 8         | TBTOCINT | W1C  | 0     | GPTM TimerB Time-Out Interrupt Clear<br>0: The interrupt is unaffected.<br>1: The interrupt is cleared. |
| 7:4       | reserved | RO   | 0     | Reserved bits return an indeterminate value, and should never be changed.                               |
| 3         | RTCCINT  | W1C  | 0     | GPTM RTC Interrupt Clear<br>0: The interrupt is unaffected.<br>1: The interrupt is cleared.             |
| 2         | CAECINT  | W1C  | 0     | GPTM CaptureA Event Interrupt Clear<br>0: The interrupt is unaffected.<br>1: The interrupt is cleared.  |
| 1         | CAMCINT  | W1C  | 0     | GPTM CaptureA Match Raw Interrupt<br>This is the CaptureA match interrupt status after masking.         |
| 0         | TATOCINT | W1C  | 0     | GPTM TimerA Time-Out Raw Interrupt<br>0: The interrupt is unaffected.<br>1: The interrupt is cleared.   |

**Register 9: GPTM TimerA Interval Load (GPTMTAILR), offset 0x028**

This register is used to load the starting count value into the timer. When GPTM is configured to one of the 32-bit modes, **GPTMTAILR** appears as a 32-bit register (the upper 16-bits correspond to the contents of the **GPTM TimerB Interval Load (GPTMTBILR)** register). In 16-bit mode, the upper 16 bits of this register read as 0s and have no effect on the state of **GPTMTBILR**.

GPTM TimerA Interval Load (GPTMTAILR)

Offset 0x028



1/0 = 1 if timer is configured in 32-bit mode; 0 if timer is configured in 16-bit mode.

| Bit/Field | Name   | Type | Reset  | Description   |
|-----------|--------|------|--|---|
| 31:16     | TAILRH | R/W  | 0xFFFF<br>(32-bit mode)<br><br>0x0000<br>(16-bit mode) | GPTM TimerA Interval Load Register High<br><br>When configured for 32-bit mode via the <b>GPTMCFG</b> register, the <b>GPTM TimerB Interval Load (GPTMTBILR)</b> register loads this value on a write. A read returns the current value of <b>GPTMTBILR</b> .<br><br>In 16-bit mode, this field reads as 0 and does not have an effect on the state of <b>GPTMTBILR</b> . |
| 15:0      | TAILRL | R/W  | 0xFFFF   | GPTM TimerA Interval Load Register Low<br><br>For both 16- and 32-bit modes, writing this field loads the counter for TimerA. A read returns the current value of <b>GPTMTAILR</b> .  |

**Register 10: GPTM TimerB Interval Load (GPTMTBILR), offset 0x02C**

This register is used to load the starting count value into TimerB. When the GPTM is configured to a 32-bit mode, **GPTMTBILR** returns the current value of TimerB and ignores writes.

GPTM TimerB Interval Load (GPTMTBILR)

Offset 0x02C

|       |          |     |     |     |     |     |     |     |     |     |     |     |     |     |     |     |
|-------|----------|-----|-----|-----|-----|-----|-----|-----|-----|-----|-----|-----|-----|-----|-----|-----|
|       | 31       | 30  | 29  | 28  | 27  | 26  | 25  | 24  | 23  | 22  | 21  | 20  | 19  | 18  | 17  | 16  |
|       | reserved |     |     |     |     |     |     |     |     |     |     |     |     |     |     |     |
| Type  | RO       | RO  | RO  | RO  | RO  | RO  | RO  | RO  | RO  | RO  | RO  | RO  | RO  | RO  | RO  | RO  |
| Reset | 0        | 0   | 0   | 0   | 0   | 0   | 0   | 0   | 0   | 0   | 0   | 0   | 0   | 0   | 0   | 0   |
|       | 15       | 14  | 13  | 12  | 11  | 10  | 9   | 8   | 7   | 6   | 5   | 4   | 3   | 2   | 1   | 0   |
|       | TBILRL   |     |     |     |     |     |     |     |     |     |     |     |     |     |     |     |
| Type  | R/W      | R/W | R/W | R/W | R/W | R/W | R/W | R/W | R/W | R/W | R/W | R/W | R/W | R/W | R/W | R/W |
| Reset | 1        | 1   | 1   | 1   | 1   | 1   | 1   | 1   | 1   | 1   | 1   | 1   | 1   | 1   | 1   | 1   |

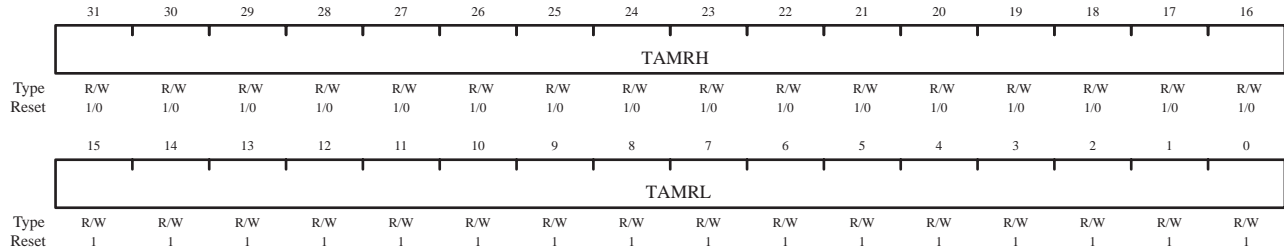
| Bit/Field | Name     | Type | Reset  | Description  |
|-----------|----------|------|--------|--|
| 31:16     | reserved | RO   | 0      | Reserved bits return an indeterminate value, and should never be changed.  |
| 15:0      | TBILRL   | R/W  | 0xFFFF | GPTM TimerB Interval Load Register<br>When the GPTM is not configured as a 32-bit timer, a write to this field updates <b>GPTMTBILR</b> . In 32-bit mode, writes are ignored, and reads return the current value of <b>GPTMTBILR</b> . |

**Register 11: GPTM TimerA Match (GPTMTAMATCHR), offset 0x030**

This register is used in 32-bit Real-Time Clock mode and 16-bit PWM and Input Edge Count modes.

GPTM TimerA Match (GPTMTAMATCHR)

Offset 0x030



1/0 = 1 if timer is configured in 32-bit mode; 0 if timer is configured in 16-bit mode.

| Bit/Field | Name  | Type | Reset  | Description  |
|-----------|-------|------|--|--|
| 31:16     | TAMRH | R/W  | 0xFFFF<br>(32-bit mode)<br><br>0x0000<br>(16-bit mode) | GPTM TimerA Match Register High<br><br>When configured for 32-bit Real-Time Clock (RTC) mode via the <b>GPTMCFG</b> register, this value is compared to the upper half of <b>GPTMTAR</b> , to determine match events.<br><br>In 16-bit mode, this field reads as 0 and does not have an effect on the state of <b>GPTMTBMATCHR</b> .   |
| 15:0      | TAMRL | R/W  | 0xFFFF   | GPTM TimerA Match Register Low<br><br>When configured for 32-bit Real-Time Clock (RTC) mode via the <b>GPTMCFG</b> register, this value is compared to the lower half of <b>GPTMTAR</b> , to determine match events.<br><br>When configured for PWM mode, this value along with <b>GPTMTAILR</b> , determines the duty cycle of the output PWM signal.<br><br>When configured for Edge Count mode, this value along with <b>GPTMTAILR</b> , determines how many edge events are counted. The total number of edge events counted is equal to the value in <b>GPTMTAILR</b> minus this value. |

**Register 12: GPTM TimerB Match (GPTMTBMATCHR), offset 0x034**

This register is used in 32-bit Real-Time Clock mode and 16-bit PWM and Input Edge Count modes.

GPTM TimerB Match (GPTMTBMATCHR)

Offset 0x034

|       |          |     |     |     |     |     |     |     |     |     |     |     |     |     |     |     |
|-------|----------|-----|-----|-----|-----|-----|-----|-----|-----|-----|-----|-----|-----|-----|-----|-----|
|       | 31       | 30  | 29  | 28  | 27  | 26  | 25  | 24  | 23  | 22  | 21  | 20  | 19  | 18  | 17  | 16  |
|       | reserved |     |     |     |     |     |     |     |     |     |     |     |     |     |     |     |
| Type  | RO       | RO  | RO  | RO  | RO  | RO  | RO  | RO  | RO  | RO  | RO  | RO  | RO  | RO  | RO  | RO  |
| Reset | 0        | 0   | 0   | 0   | 0   | 0   | 0   | 0   | 0   | 0   | 0   | 0   | 0   | 0   | 0   | 0   |
|       | 15       | 14  | 13  | 12  | 11  | 10  | 9   | 8   | 7   | 6   | 5   | 4   | 3   | 2   | 1   | 0   |
|       | TBMRL    |     |     |     |     |     |     |     |     |     |     |     |     |     |     |     |
| Type  | R/W      | R/W | R/W | R/W | R/W | R/W | R/W | R/W | R/W | R/W | R/W | R/W | R/W | R/W | R/W | R/W |
| Reset | 0        | 0   | 0   | 0   | 0   | 0   | 0   | 0   | 0   | 0   | 0   | 0   | 0   | 0   | 0   | 0   |

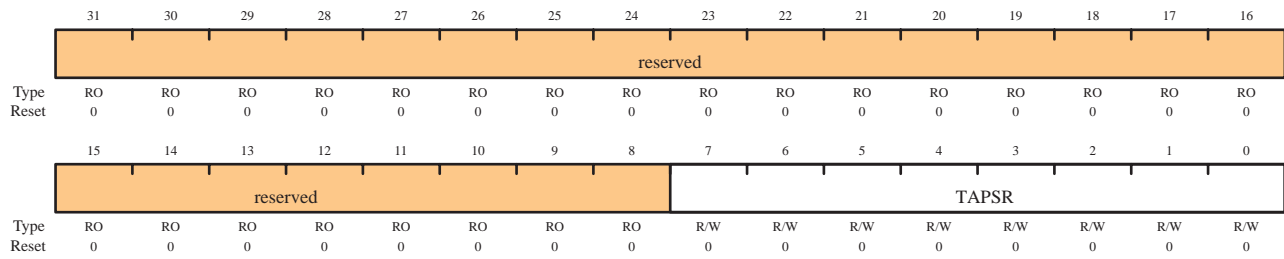
| Bit/Field | Name     | Type | Reset  | Description   |
|-----------|----------|------|--------|---|
| 31:16     | reserved | RO   | 0      | Reserved bits return an indeterminate value, and should never be changed.   |
| 15:0      | TBMRL    | R/W  | 0xFFFF | <p>GPTM TimerB Match Register Low</p> <p>When configured for PWM mode, this value along with <b>GPTMTBILR</b>, determines the duty cycle of the output PWM signal.</p> <p>When configured for Edge Count mode, this value along with <b>GPTMTBILR</b>, determines how many edge events are counted. The total number of edge events counted is equal to the value in <b>GPTMTBILR</b> minus this value.</p> |

**Register 13: GPTM TimerA Prescale (GPTMTAPR), offset 0x038**

This register allows software to extend the range of the 16-bit timers.

GPTM TimerA Prescale (GPTMTAPR)

Offset 0x038



| Bit/Field | Name     | Type | Reset | Description  |
|-----------|----------|------|-------|--|
| 31:8      | reserved | RO   | 0     | Reserved bits return an indeterminate value, and should never be changed.  |
| 7:0       | TAPSR    | R/W  | 0     | GPTM TimerA Prescale<br>The register loads this value on a write. A read returns the current value of the register.<br>Refer to Table 9-1 on page 144 for more details and an example. |

**Register 14: GPTM TimerB Prescale (GPTMTBPR), offset 0x03C**

This register allows software to extend the range of the 16-bit timers.

## GPTM TimerB Prescale (GPTMTBPR)

Offset 0x03C

|       |          |    |    |    |    |    |    |    |       |     |     |     |     |     |     |     |
|-------|----------|----|----|----|----|----|----|----|-------|-----|-----|-----|-----|-----|-----|-----|
|       | 31       | 30 | 29 | 28 | 27 | 26 | 25 | 24 | 23    | 22  | 21  | 20  | 19  | 18  | 17  | 16  |
|       | reserved |    |    |    |    |    |    |    |       |     |     |     |     |     |     |     |
| Type  | RO       | RO | RO | RO | RO | RO | RO | RO | RO    | RO  | RO  | RO  | RO  | RO  | RO  | RO  |
| Reset | 0        | 0  | 0  | 0  | 0  | 0  | 0  | 0  | 0     | 0   | 0   | 0   | 0   | 0   | 0   | 0   |
|       | 15       | 14 | 13 | 12 | 11 | 10 | 9  | 8  | 7     | 6   | 5   | 4   | 3   | 2   | 1   | 0   |
|       | reserved |    |    |    |    |    |    |    | TBPSR |     |     |     |     |     |     |     |
| Type  | RO       | RO | RO | RO | RO | RO | RO | RO | R/W   | R/W | R/W | R/W | R/W | R/W | R/W | R/W |
| Reset | 0        | 0  | 0  | 0  | 0  | 0  | 0  | 0  | 0     | 0   | 0   | 0   | 0   | 0   | 0   | 0   |

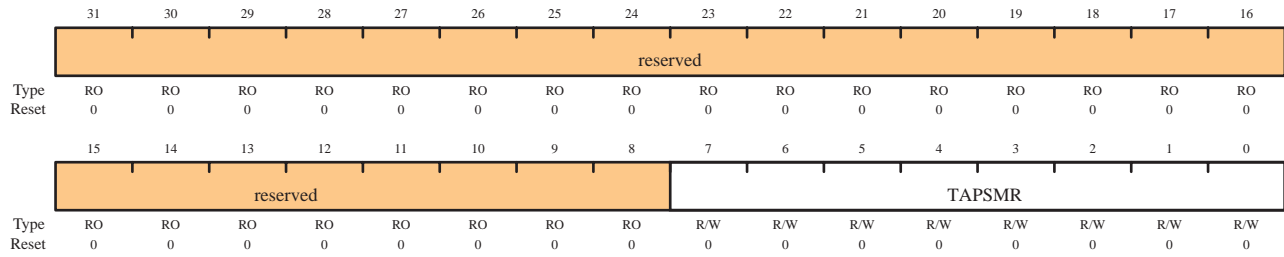
| Bit/Field | Name     | Type | Reset | Description   |
|-----------|----------|------|-------|---|
| 31:8      | reserved | RO   | 0     | Reserved bits return an indeterminate value, and should never be changed.   |
| 7:0       | TBPSR    | R/W  | 0     | GPTM TimerB Prescale<br>The register loads this value on a write. A read returns the current value of this register.<br>Refer to Table 9-1 on page 144 for more details and an example. |

**Register 15: GPTM TimerA Prescale Match (GPTMTAPMR), offset 0x040**

This register effectively extends the range of **GPTMTAMATCHR** to 24 bits.

GPTM TimerA Prescale Match (GPTMTAPMR)

Offset 0x040



| Bit/Field | Name     | Type | Reset | Description  |
|-----------|----------|------|-------|--|
| 31:8      | reserved | RO   | 0     | Reserved bits return an indeterminate value, and should never be changed.  |
| 7:0       | TAPSMR   | R/W  | 0     | GPTM TimerA Prescale Match<br>This value is used alongside <b>GPTMTAMATCHR</b> to detect timer match events while using a prescaler. |



**Register 16: GPTM TimerB Prescale Match (GPTMTBPMR), offset 0x044**

This register effectively extends the range of **GPTMTBMATCHR** to 24 bits.

## GPTM TimerB Prescale Match (GPTMTBPMR)

Offset 0x044

|       |          |    |    |    |    |    |    |    |        |     |     |     |     |     |     |     |
|-------|----------|----|----|----|----|----|----|----|--------|-----|-----|-----|-----|-----|-----|-----|
|       | 31       | 30 | 29 | 28 | 27 | 26 | 25 | 24 | 23     | 22  | 21  | 20  | 19  | 18  | 17  | 16  |
|       | reserved |    |    |    |    |    |    |    |        |     |     |     |     |     |     |     |
| Type  | RO       | RO | RO | RO | RO | RO | RO | RO | RO     | RO  | RO  | RO  | RO  | RO  | RO  | RO  |
| Reset | 0        | 0  | 0  | 0  | 0  | 0  | 0  | 0  | 0      | 0   | 0   | 0   | 0   | 0   | 0   | 0   |
|       | 15       | 14 | 13 | 12 | 11 | 10 | 9  | 8  | 7      | 6   | 5   | 4   | 3   | 2   | 1   | 0   |
|       | reserved |    |    |    |    |    |    |    | TBPSMR |     |     |     |     |     |     |     |
| Type  | RO       | RO | RO | RO | RO | RO | RO | RO | R/W    | R/W | R/W | R/W | R/W | R/W | R/W | R/W |
| Reset | 0        | 0  | 0  | 0  | 0  | 0  | 0  | 0  | 0      | 0   | 0   | 0   | 0   | 0   | 0   | 0   |

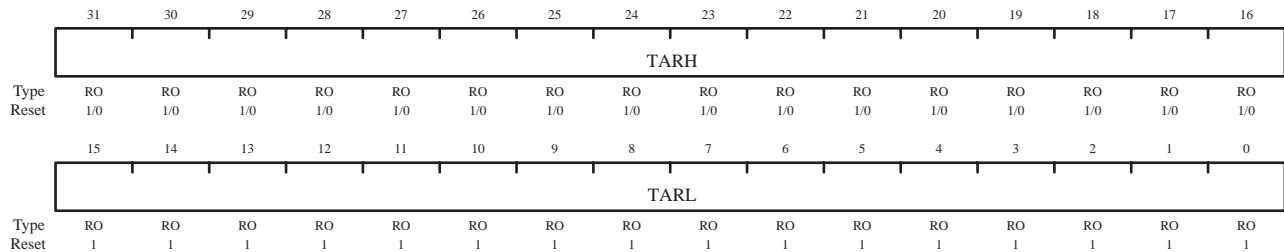
| Bit/Field | Name     | Type | Reset | Description  |
|-----------|----------|------|-------|--|
| 31:8      | reserved | RO   | 0     | Reserved bits return an indeterminate value, and should never be changed.  |
| 7:0       | TBPSMR   | R/W  | 0     | GPTM TimerB Prescale Match<br>This value is used alongside <b>GPTMTBMATCHR</b> to detect timer match events while using a prescaler. |

**Register 17: GPTM TimerA (GPTMTAR), offset 0x048**

This register shows the current value of the TimerA counter in all cases except for Input Edge Count mode. When in this mode, this register contains the time at which the last edge event took place.

GPTM TimerA (GPTMTAR)

Offset 0x048



1/0 = 1 if timer is configured in 32-bit mode; 0 if timer is configured in 16-bit mode.

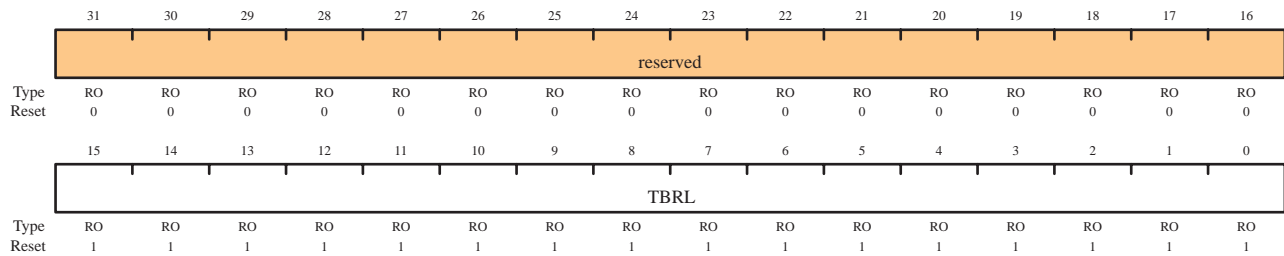
| Bit/Field | Name | Type | Reset  | Description  |
|-----------|------|------|--|--|
| 31:16     | TARH | RO   | 0xFFFF (32-bit mode)<br>0x0000 (16-bit mode) | GPTM TimerA Register High<br>If the <b>GPTMCFG</b> is in a 32-bit mode, TimerB value is read. If the <b>GPTMCFG</b> is in a 16-bit mode, this is read as zero.                                   |
| 15:0      | TARL | RO   | 0xFFFF                                       | GPTM TimerA Register Low<br>A read returns the current value of the <b>GPTM TimerA Count Register</b> , except in Input Edge Count mode, when it returns the timestamp from the last edge event. |

**Register 18: GPTM TimerB (GPTMTBR), offset 0x04C**

This register shows the current value of the TimerB counter in all cases except for Input Edge Count mode. When in this mode, this register contains the time at which the last edge event took place.

GPTM TimerB (GPTMTBR)

Offset 0x04C



| Bit/Field | Name     | Type | Reset  | Description   |
|-----------|----------|------|--------|---|
| 31:16     | reserved | RO   | 0      | Reserved bits return an indeterminate value, and should never be changed.   |
| 15:0      | TBRL     | RO   | 0xFFFF | GPTM TimerB<br>A read returns the current value of the <b>GPTM TimerB Count Register</b> , except in Input Edge Count mode, when it returns the timestamp from the last edge event. |

## 10 Watchdog Timer

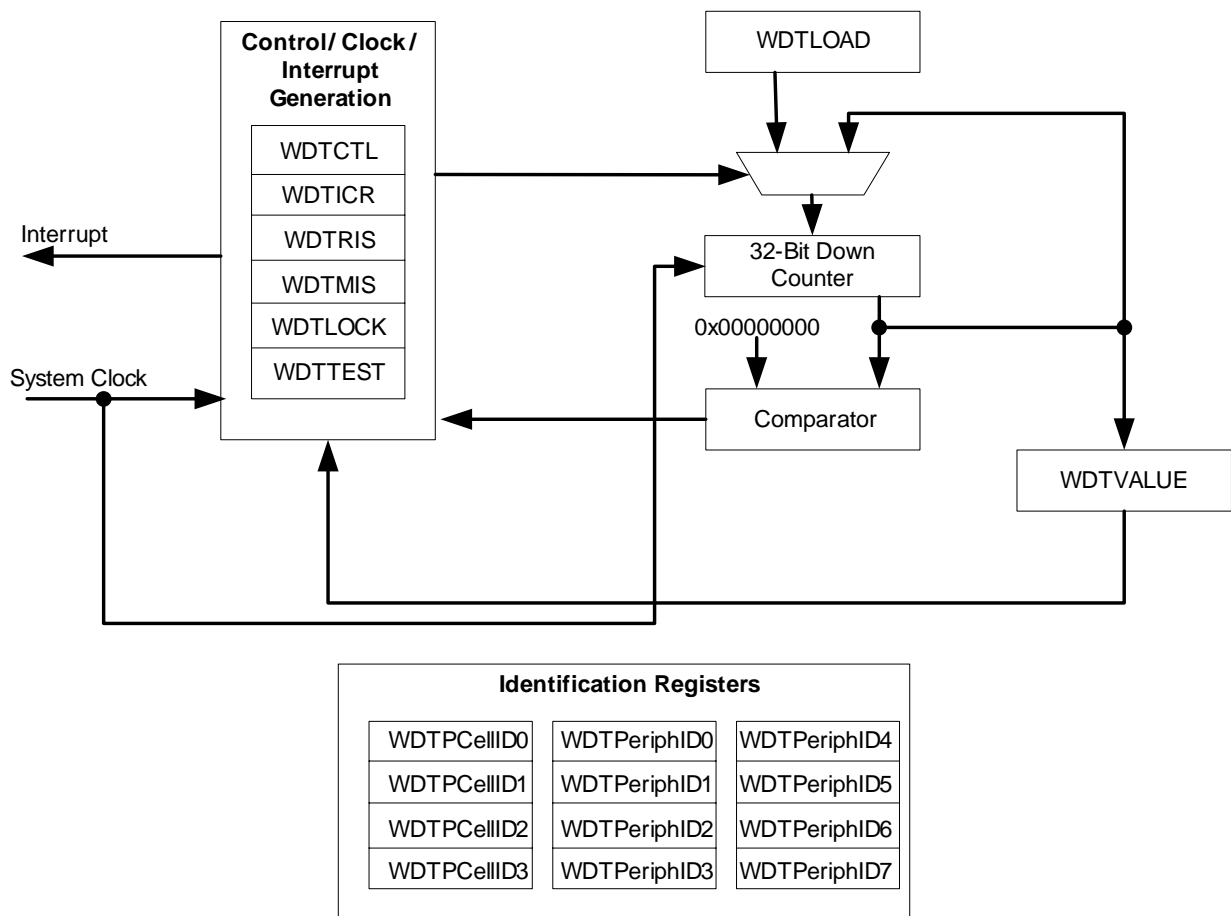
A watchdog timer can generate nonmaskable interrupts (NMIs) or a reset when a time-out value is reached. The watchdog timer is used to regain control when a system has failed due to a software error or due to the failure of an external device to respond in the expected way.

The Stellaris Watchdog Timer module consists of a 32-bit down counter, a programmable load register, interrupt generation logic, a locking register, and user-enabled stalling.

The Watchdog Timer can be configured to generate an interrupt to the controller on its first time-out, and to generate a reset signal on its second time-out. Once the Watchdog Timer has been configured, the lock register can be written to prevent the timer configuration from being inadvertently altered.

### 10.1 Block Diagram

Figure 10-1. WDT Module Block Diagram



## 10.2 Functional Description

The Watchdog Timer module consists of a 32-bit down counter, a programmable load register, interrupt generation logic, and a locking register. Once the Watchdog Timer has been configured, the **Watchdog Timer Lock (WDTLOCK)** register is written, which prevents the timer configuration from being inadvertently altered by software.

The Watchdog Timer module generates the first time-out signal when the 32-bit counter reaches the zero state after being enabled; enabling the counter also enables the watchdog timer interrupt. After the first time-out event, the 32-bit counter is re-loaded with the value of the **Watchdog Timer Load (WDTLOAD)** register, and the timer resumes counting down from that value.

If the timer counts down to its zero state again before the first time-out interrupt is cleared, and the reset signal has been enabled (via the `WatchdogResetEnable` function), the Watchdog timer asserts its reset signal to the system. If the interrupt is cleared before the 32-bit counter reaches its second time-out, the 32-bit counter is loaded with the value in the **WDTLOAD** register, and counting resumes from that value.

If **WDTLOAD** is written with a new value while the Watchdog Timer counter is counting, then the counter is loaded with the new value and continues counting.

Writing to **WDTLOAD** does not clear an active interrupt. An interrupt must be specifically cleared by writing to the **Watchdog Interrupt Clear (WDTICR)** register.

The Watchdog module interrupt and reset generation can be enabled or disabled as required. When the interrupt is re-enabled, the 32-bit counter is preloaded with the load register value and not its last state.

## 10.3 Initialization and Configuration

To use the WDT, its peripheral clock must be enabled by setting the `WDT` bit in the **RCGC0** register. The Watchdog Timer is configured using the following sequence:

1. Load the **WDTLOAD** register with the desired timer load value.
2. If the Watchdog is configured to trigger system resets, set the `RESEN` bit in the **WDTCTL** register.
3. Set the `INTEN` bit in the **WDTCTL** register to enable the Watchdog and lock the control register.

If software requires that all of the watchdog registers are locked, the Watchdog Timer module can be fully locked by writing any value to the **WDTLOCK** register. To unlock the Watchdog Timer, write a value of `0x1ACCE551`.

## 10.4 Register Map

Table 10-1 lists the Watchdog registers. The offset listed is a hexadecimal increment to the register's address, relative to the Watchdog Timer base address of `0x40000000`.

Table 10-1. WDT Register Map

| Offset | Name     | Reset      | Type | Description   | See page |
|--------|----------|------------|------|---------------|----------|
| 0x000  | WDTLOAD  | 0xFFFFFFFF | R/W  | Load          | 175      |
| 0x004  | WDTVALUE | 0xFFFFFFFF | RO   | Current value | 176      |
| 0x008  | WDTCTL   | 0x00000000 | R/W  | Control       | 177      |

**Table 10-1. WDT Register Map (Continued)**

| Offset | Name         | Reset      | Type | Description                 | See page |
|--------|--------------|------------|------|-----------------------------|----------|
| 0x00C  | WDTICR       | -          | WO   | Interrupt clear             | 178      |
| 0x010  | WDTRIS       | 0x00000000 | RO   | Raw interrupt status        | 179      |
| 0x014  | WDTMIS       | 0x00000000 | RO   | Masked interrupt status     | 180      |
| 0x418  | WDTTEST      | 0x00000000 | R/W  | Watchdog stall enable       | 182      |
| 0xC00  | WDTLOCK      | 0x00000000 | R/W  | Lock                        | 181      |
| 0xFD0  | WDTPeriphID4 | 0x00000000 | RO   | Peripheral identification 4 | 183      |
| 0xFD4  | WDTPeriphID5 | 0x00000000 | RO   | Peripheral identification 5 | 184      |
| 0xFD8  | WDTPeriphID6 | 0x00000000 | RO   | Peripheral identification 6 | 185      |
| 0xFDC  | WDTPeriphID7 | 0x00000000 | RO   | Peripheral identification 7 | 186      |
| 0xFE0  | WDTPeriphID0 | 0x00000005 | RO   | Peripheral identification 0 | 187      |
| 0xFE4  | WDTPeriphID1 | 0x00000018 | RO   | Peripheral identification 1 | 188      |
| 0xFE8  | WDTPeriphID2 | 0x00000018 | RO   | Peripheral identification 2 | 189      |
| 0xFEC  | WDTPeriphID3 | 0x00000001 | RO   | Peripheral identification 3 | 190      |
| 0xFF0  | WDTPCellID0  | 0x0000000D | RO   | PrimeCell identification 0  | 191      |
| 0xFF4  | WDTPCellID1  | 0x000000F0 | RO   | PrimeCell identification 1  | 192      |
| 0xFF8  | WDTPCellID2  | 0x00000005 | RO   | PrimeCell identification 2  | 193      |
| 0xFFC  | WDTPCellID3  | 0x000000B1 | RO   | PrimeCell identification 3  | 194      |

## 10.5 Register Descriptions

The remainder of this section lists and describes the WDT registers, in numerical order by address offset.

**Register 1: Watchdog Load (WDTLOAD), offset 0x000**

This register is the 32-bit interval value used by the 32-bit counter. When this register is written, the value is immediately loaded and the counter restarts counting down from the new value. If the **WDTLOAD** register is loaded with 0x00000000, an interrupt is immediately generated.

Watchdog Load (WDTLOAD)

Offset 0x000

|       | 31      | 30  | 29  | 28  | 27  | 26  | 25  | 24  | 23  | 22  | 21  | 20  | 19  | 18  | 17  | 16  |
|-------|---------|-----|-----|-----|-----|-----|-----|-----|-----|-----|-----|-----|-----|-----|-----|-----|
|       | WDTLoad |     |     |     |     |     |     |     |     |     |     |     |     |     |     |     |
| Type  | R/W     | R/W | R/W | R/W | R/W | R/W | R/W | R/W | R/W | R/W | R/W | R/W | R/W | R/W | R/W | R/W |
| Reset | 1       | 1   | 1   | 1   | 1   | 1   | 1   | 1   | 1   | 1   | 1   | 1   | 1   | 1   | 1   | 1   |
|       | 15      | 14  | 13  | 12  | 11  | 10  | 9   | 8   | 7   | 6   | 5   | 4   | 3   | 2   | 1   | 0   |
|       | WDTLoad |     |     |     |     |     |     |     |     |     |     |     |     |     |     |     |
| Type  | R/W     | R/W | R/W | R/W | R/W | R/W | R/W | R/W | R/W | R/W | R/W | R/W | R/W | R/W | R/W | R/W |
| Reset | 1       | 1   | 1   | 1   | 1   | 1   | 1   | 1   | 1   | 1   | 1   | 1   | 1   | 1   | 1   | 1   |

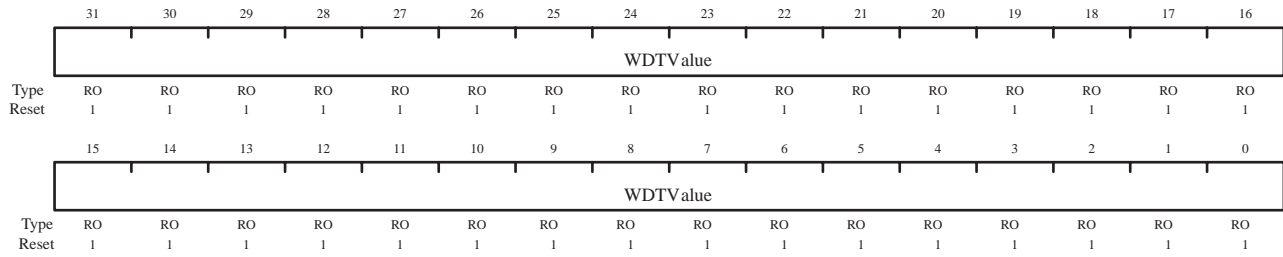
| Bit/Field | Name    | Type | Reset      | Description         |
|-----------|---------|------|------------|---------------------|
| 31:0      | WDTLoad | R/W  | 0xFFFFFFFF | Watchdog Load Value |

**Register 2: Watchdog Value (WDTVALUE), offset 0x004**

This register contains the current count value of the timer.

Watchdog Value (WDTVALUE)

Offset 0x004



| Bit/Field | Name     | Type | Reset      | Description   |
|-----------|----------|------|------------|---|
| 31:0      | WDTValue | RO   | 0xFFFFFFFF | Watchdog Value<br>Current value of the 32-bit down counter. |



**Register 3: Watchdog Control (WDTCTL), offset 0x008**

This register is the watchdog control register. The watchdog timer can be configured to generate a reset signal (upon second time-out) or an interrupt on time-out.

When the watchdog interrupt has been enabled, all subsequent writes to the control register are ignored. The only mechanism that can re-enable writes is a hardware reset.

## Watchdog Control (WDTCTL)

Offset 0x008

|       |          |    |    |    |    |    |    |    |    |    |    |    |    |    |       |       |     |
|-------|----------|----|----|----|----|----|----|----|----|----|----|----|----|----|-------|-------|-----|
|       | 31       | 30 | 29 | 28 | 27 | 26 | 25 | 24 | 23 | 22 | 21 | 20 | 19 | 18 | 17    | 16    |     |
|       | reserved |    |    |    |    |    |    |    |    |    |    |    |    |    |       |       |     |
| Type  | RO       | RO | RO | RO | RO | RO | RO | RO | RO | RO | RO | RO | RO | RO | RO    | RO    |     |
| Reset | 0        | 0  | 0  | 0  | 0  | 0  | 0  | 0  | 0  | 0  | 0  | 0  | 0  | 0  | 0     | 0     |     |
|       | 15       | 14 | 13 | 12 | 11 | 10 | 9  | 8  | 7  | 6  | 5  | 4  | 3  | 2  | 1     | 0     |     |
|       | reserved |    |    |    |    |    |    |    |    |    |    |    |    |    | RESEN | INTEN |     |
| Type  | RO       | RO | RO | RO | RO | RO | RO | RO | RO | RO | RO | RO | RO | RO | RO    | R/W   | R/W |
| Reset | 0        | 0  | 0  | 0  | 0  | 0  | 0  | 0  | 0  | 0  | 0  | 0  | 0  | 0  | 0     | 0     | 0   |

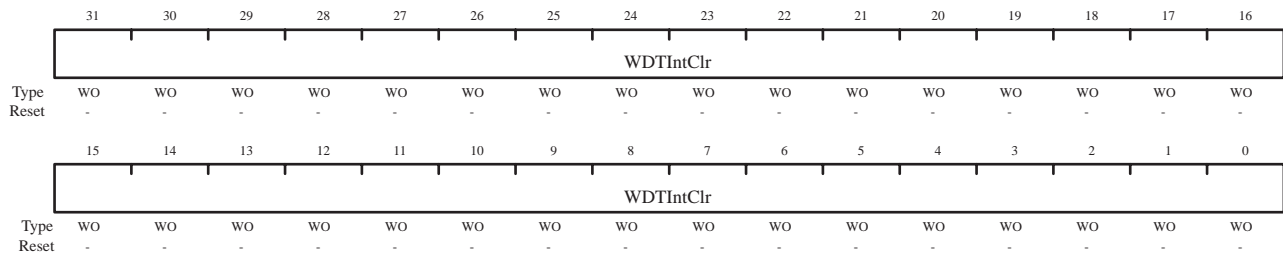
| Bit/Field | Name     | Type | Reset | Description  |
|-----------|----------|------|-------|--|
| 31:2      | reserved | RO   | 0     | Reserved bits return an indeterminate value, and should never be changed.  |
| 1         | RESEN    | R/W  | 0     | Watchdog Reset Enable<br>0: Disabled.<br>1: Enable the Watchdog module reset output.   |
| 0         | INTEN    | R/W  | 0     | Watchdog Interrupt Enable<br>0: Interrupt event disabled (once this bit is set, it can only be cleared by a hardware reset)<br>1: Interrupt event enabled. Once enabled, all writes are ignored. |

**Register 4: Watchdog Interrupt Clear (WDTICR), offset 0x00C**

This register is the interrupt clear register. A write of any value to this register clears the Watchdog interrupt and reloads the 32-bit counter from the **WDTLOAD** register. Value for a read or reset is indeterminate.

Watchdog Interrupt Clear (WDTICR)

Offset 0x00C



| Bit/Field | Name      | Type | Reset | Description              |
|-----------|-----------|------|-------|--------------------------|
| 31:0      | WDTIntClr | WO   | -     | Watchdog Interrupt Clear |

**Register 5: Watchdog Raw Interrupt Status (WDTRIS), offset 0x010**

This register is the raw interrupt status register. Watchdog interrupt events can be monitored via this register if the controller interrupt is masked.

## Watchdog Raw Interrupt Status (WDTRIS)

Offset 0x010

|       |          |    |    |    |    |    |    |    |    |    |    |    |    |    |    |    |
|-------|----------|----|----|----|----|----|----|----|----|----|----|----|----|----|----|----|
|       | 31       | 30 | 29 | 28 | 27 | 26 | 25 | 24 | 23 | 22 | 21 | 20 | 19 | 18 | 17 | 16 |
|       | reserved |    |    |    |    |    |    |    |    |    |    |    |    |    |    |    |
| Type  | RO       | RO | RO | RO | RO | RO | RO | RO | RO | RO | RO | RO | RO | RO | RO | RO |
| Reset | 0        | 0  | 0  | 0  | 0  | 0  | 0  | 0  | 0  | 0  | 0  | 0  | 0  | 0  | 0  | 0  |
|       | 15       | 14 | 13 | 12 | 11 | 10 | 9  | 8  | 7  | 6  | 5  | 4  | 3  | 2  | 1  | 0  |
|       | reserved |    |    |    |    |    |    |    |    |    |    |    |    |    |    |    |
| Type  | RO       | RO | RO | RO | RO | RO | RO | RO | RO | RO | RO | RO | RO | RO | RO | RO |
| Reset | 0        | 0  | 0  | 0  | 0  | 0  | 0  | 0  | 0  | 0  | 0  | 0  | 0  | 0  | 0  | 0  |

| Bit/Field | Name     | Type | Reset | Description   |
|-----------|----------|------|-------|---|
| 31:1      | reserved | RO   | 0     | Reserved bits return an indeterminate value, and should never be changed.                             |
| 0         | WDTRIS   | RO   | 0     | Watchdog Raw Interrupt Status<br>Gives the raw interrupt state (prior to masking) of <b>WDTINTR</b> . |

**Register 6: Watchdog Masked Interrupt Status (WDTMIS), offset 0x014**

This register is the masked interrupt status register. The value of this register is the logical AND of the raw interrupt bit and the Watchdog interrupt enable bit.

Watchdog Masked Interrupt Status (WDTMIS)

Offset 0x014

|       |          |    |    |    |    |    |    |    |    |    |    |    |    |    |    |        |
|-------|----------|----|----|----|----|----|----|----|----|----|----|----|----|----|----|--------|
|       | 31       | 30 | 29 | 28 | 27 | 26 | 25 | 24 | 23 | 22 | 21 | 20 | 19 | 18 | 17 | 16     |
|       | reserved |    |    |    |    |    |    |    |    |    |    |    |    |    |    |        |
| Type  | RO       | RO | RO | RO | RO | RO | RO | RO | RO | RO | RO | RO | RO | RO | RO | RO     |
| Reset | 0        | 0  | 0  | 0  | 0  | 0  | 0  | 0  | 0  | 0  | 0  | 0  | 0  | 0  | 0  | 0      |
|       | 15       | 14 | 13 | 12 | 11 | 10 | 9  | 8  | 7  | 6  | 5  | 4  | 3  | 2  | 1  | 0      |
|       | reserved |    |    |    |    |    |    |    |    |    |    |    |    |    |    | WDTMIS |
| Type  | RO       | RO | RO | RO | RO | RO | RO | RO | RO | RO | RO | RO | RO | RO | RO | RO     |
| Reset | 0        | 0  | 0  | 0  | 0  | 0  | 0  | 0  | 0  | 0  | 0  | 0  | 0  | 0  | 0  | 0      |

| Bit/Field | Name     | Type | Reset | Description   |
|-----------|----------|------|-------|---|
| 31:1      | reserved | RO   | 0     | Reserved bits return an indeterminate value, and should never be changed.   |
| 0         | WDTMIS   | RO   | 0     | Watchdog Masked Interrupt Status<br>Gives the masked interrupt state (after masking) of the <b>WDTINTR</b> interrupt. |

**Register 7: Watchdog Lock (WDTLOCK), offset 0xC00**

Writing 0x1ACCE551 to the **WDTLOCK** register enables write access to all other registers. Writing any other value to the **WDTLOCK** register re-enables the locked state for register writes to all the other registers. Reading the **WDTLOCK** register returns the lock status rather than the 32-bit value written. Therefore, when write accesses are disabled, reading the **WDTLOCK** register returns 0x00000001 (when locked; otherwise, the returned value is 0x00000000 (unlocked)).

## Watchdog Lock (WDTLOCK)

Offset 0xC00

|       | 31      | 30  | 29  | 28  | 27  | 26  | 25  | 24  | 23  | 22  | 21  | 20  | 19  | 18  | 17  | 16  |
|-------|---------|-----|-----|-----|-----|-----|-----|-----|-----|-----|-----|-----|-----|-----|-----|-----|
|       | WDTLock |     |     |     |     |     |     |     |     |     |     |     |     |     |     |     |
| Type  | R/W     | R/W | R/W | R/W | R/W | R/W | R/W | R/W | R/W | R/W | R/W | R/W | R/W | R/W | R/W | R/W |
| Reset | 0       | 0   | 0   | 0   | 0   | 0   | 0   | 0   | 0   | 0   | 0   | 0   | 0   | 0   | 0   | 0   |
|       | 15      | 14  | 13  | 12  | 11  | 10  | 9   | 8   | 7   | 6   | 5   | 4   | 3   | 2   | 1   | 0   |
|       | WDTLock |     |     |     |     |     |     |     |     |     |     |     |     |     |     |     |
| Type  | R/W     | R/W | R/W | R/W | R/W | R/W | R/W | R/W | R/W | R/W | R/W | R/W | R/W | R/W | R/W | R/W |
| Reset | 0       | 0   | 0   | 0   | 0   | 0   | 0   | 0   | 0   | 0   | 0   | 0   | 0   | 0   | 0   | 0   |

| Bit/Field | Name    | Type | Reset  | Description   |
|-----------|---------|------|--------|---|
| 31:0      | WDTLock | R/W  | 0x0000 | <p>Watchdog Lock</p> <p>A write of the value 0x1ACCE551 unlocks the watchdog registers for write access. A write of any other value reapplies the lock, preventing any register updates.</p> <p>A read of this register returns the following values:</p> <p>Locked: 0x00000001</p> <p>Unlocked: 0x00000000</p> |

**Register 8: Watchdog Test (WDTTEST), offset 0x418**

This register provides user-enabled stalling when the microcontroller asserts the CPU halt flag during debug.

Watchdog Test (WDTTEST)

Offset 0x418

|       |          |    |    |    |    |    |    |       |          |    |    |    |    |    |    |    |
|-------|----------|----|----|----|----|----|----|-------|----------|----|----|----|----|----|----|----|
|       | 31       | 30 | 29 | 28 | 27 | 26 | 25 | 24    | 23       | 22 | 21 | 20 | 19 | 18 | 17 | 16 |
|       | reserved |    |    |    |    |    |    |       |          |    |    |    |    |    |    |    |
| Type  | RO       | RO | RO | RO | RO | RO | RO | RO    | RO       | RO | RO | RO | RO | RO | RO | RO |
| Reset | 0        | 0  | 0  | 0  | 0  | 0  | 0  | 0     | 0        | 0  | 0  | 0  | 0  | 0  | 0  | 0  |
|       | 15       | 14 | 13 | 12 | 11 | 10 | 9  | 8     | 7        | 6  | 5  | 4  | 3  | 2  | 1  | 0  |
|       | reserved |    |    |    |    |    |    | STALL | reserved |    |    |    |    |    |    |    |
| Type  | RO       | RO | RO | RO | RO | RO | RO | R/W   | RO       | RO | RO | RO | RO | RO | RO | RO |
| Reset | 0        | 0  | 0  | 0  | 0  | 0  | 0  | 0     | 0        | 0  | 0  | 0  | 0  | 0  | 0  | 0  |

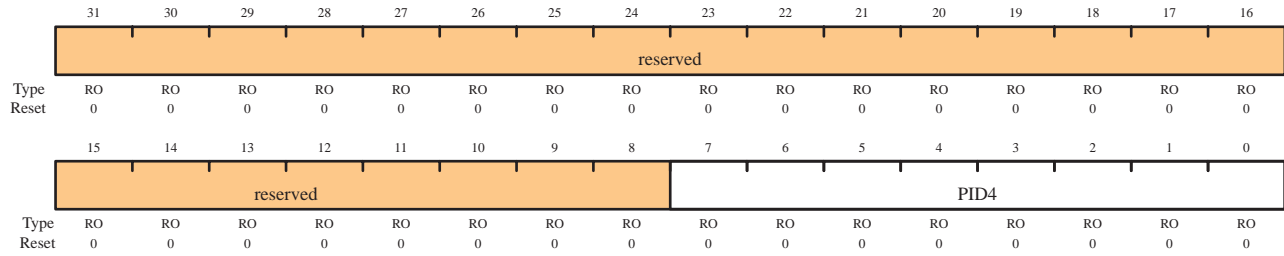
| Bit/Field | Name     | Type | Reset | Description  |
|-----------|----------|------|-------|--|
| 31:9      | reserved | RO   | 0     | Reserved bits return an indeterminate value, and should never be changed.  |
| 8         | STALL    | R/W  | 0     | <p>Watchdog Stall Enable</p> <p>When set to 1, if the Stellaris microcontroller is stopped with a debugger, the watchdog timer stops counting. Once the microcontroller is restarted, the watchdog timer resumes counting.</p> |
| 7:0       | reserved | RO   | 0     | Reserved bits return an indeterminate value, and should never be changed.  |

**Register 9: Watchdog Peripheral Identification 4 (WDTPeriphID4), offset 0xFD0**

The **WDTPeriphIDn** registers are hard-coded and the fields within the register determine the reset value.

Watchdog Peripheral Identification 4 (WDTPeriphID4)

Offset 0xFD0



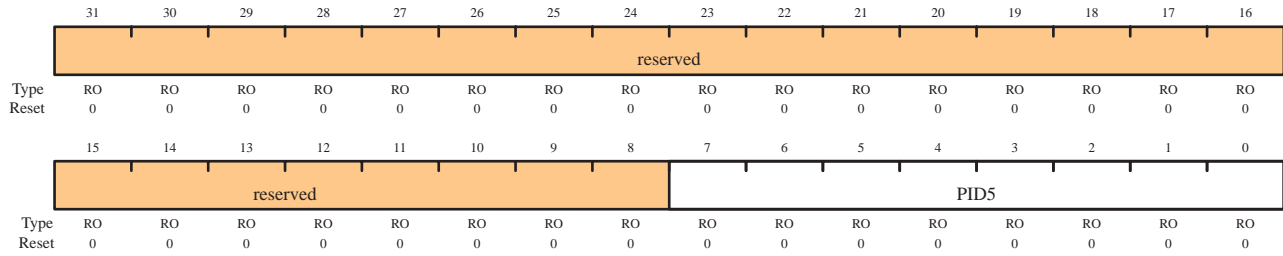
| Bit/Field | Name     | Type | Reset | Description   |
|-----------|----------|------|-------|---|
| 31:8      | reserved | RO   | 0     | Reserved bits return an indeterminate value, and should never be changed. |
| 7:0       | PID4     | RO   | 0x00  | WDT Peripheral ID Register[7:0]   |

**Register 10: Watchdog Peripheral Identification 5 (WDTPeriphID5), offset 0xFD4**

The **WDTPeriphIDn** registers are hard-coded and the fields within the register determine the reset value.

Watchdog Peripheral Identification 5 (WDTPeriphID5)

Offset 0xFD4



| Bit/Field | Name     | Type | Reset | Description   |
|-----------|----------|------|-------|---|
| 31:8      | reserved | RO   | 0     | Reserved bits return an indeterminate value, and should never be changed. |
| 7:0       | PID5     | RO   | 0x00  | WDT Peripheral ID Register[15:8]  |

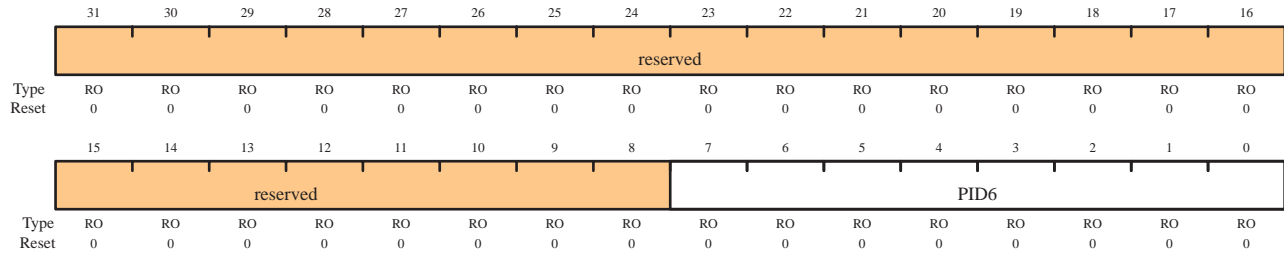


**Register 11: Watchdog Peripheral Identification 6 (WDTPeriphID6), offset 0xFD8**

The **WDTPeriphIDn** registers are hard-coded and the fields within the register determine the reset value.

Watchdog Peripheral Identification 6 (WDTPeriphID6)

Offset 0xFD8



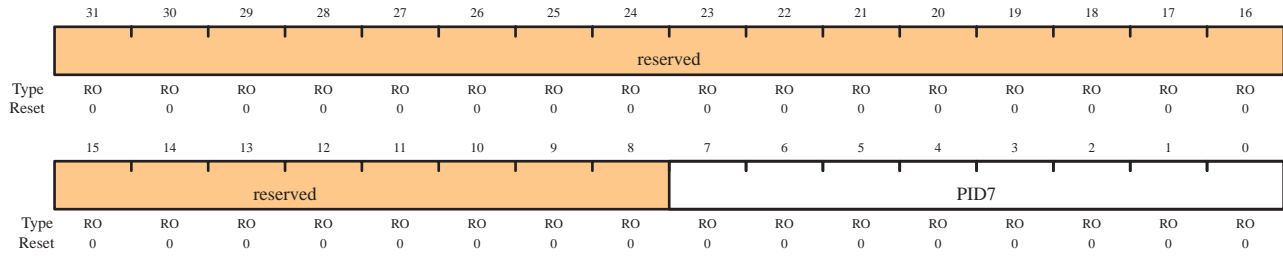
| Bit/Field | Name     | Type | Reset | Description   |
|-----------|----------|------|-------|---|
| 31:8      | reserved | RO   | 0     | Reserved bits return an indeterminate value, and should never be changed. |
| 7:0       | PID6     | RO   | 0x00  | WDT Peripheral ID Register[23:16]   |

**Register 12: Watchdog Peripheral Identification 7 (WDTPeriphID7), offset 0xFDC**

The **WDTPeriphIDn** registers are hard-coded and the fields within the register determine the reset value.

Watchdog Peripheral Identification 7 (WDTPeriphID7)

Offset 0xFDC



| Bit/Field | Name     | Type | Reset | Description   |
|-----------|----------|------|-------|---|
| 31:8      | reserved | RO   | 0     | Reserved bits return an indeterminate value, and should never be changed. |
| 7:0       | PID7     | RO   | 0x00  | WDT Peripheral ID Register[31:24]   |

**Register 13: Watchdog Peripheral Identification 0 (WDTPeriphID0), offset 0xFE0**

The **WDTPeriphIDn** registers are hard-coded and the fields within the register determine the reset value.

## Watchdog Peripheral Identification 0 (WDTPeriphID0)

Offset 0xFE0

|       |          |    |    |    |    |    |    |    |      |    |    |    |    |    |    |    |
|-------|----------|----|----|----|----|----|----|----|------|----|----|----|----|----|----|----|
|       | 31       | 30 | 29 | 28 | 27 | 26 | 25 | 24 | 23   | 22 | 21 | 20 | 19 | 18 | 17 | 16 |
|       | reserved |    |    |    |    |    |    |    |      |    |    |    |    |    |    |    |
| Type  | RO       | RO | RO | RO | RO | RO | RO | RO | RO   | RO | RO | RO | RO | RO | RO | RO |
| Reset | 0        | 0  | 0  | 0  | 0  | 0  | 0  | 0  | 0    | 0  | 0  | 0  | 0  | 0  | 0  | 0  |
|       | 15       | 14 | 13 | 12 | 11 | 10 | 9  | 8  | 7    | 6  | 5  | 4  | 3  | 2  | 1  | 0  |
|       | reserved |    |    |    |    |    |    |    | PID0 |    |    |    |    |    |    |    |
| Type  | RO       | RO | RO | RO | RO | RO | RO | RO | RO   | RO | RO | RO | RO | RO | RO | RO |
| Reset | 0        | 0  | 0  | 0  | 0  | 0  | 0  | 0  | 0    | 0  | 0  | 0  | 0  | 1  | 0  | 1  |

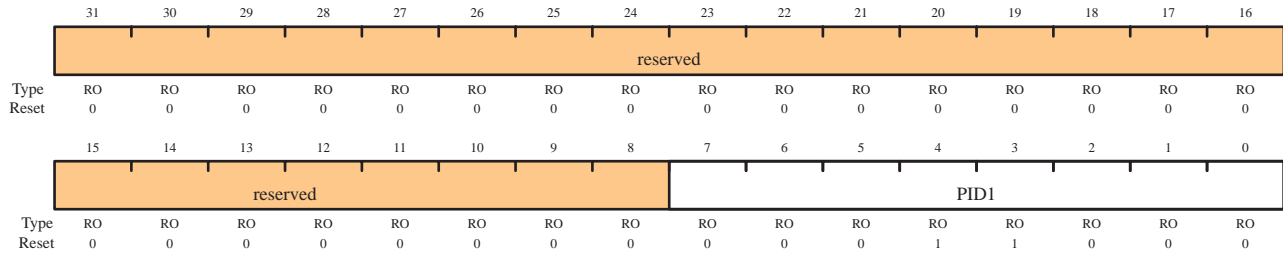
| Bit/Field | Name     | Type | Reset | Description   |
|-----------|----------|------|-------|---|
| 31:8      | reserved | RO   | 0     | Reserved bits return an indeterminate value, and should never be changed. |
| 7:0       | PID0     | RO   | 0x05  | Watchdog Peripheral ID Register[7:0]                                      |

**Register 14: Watchdog Peripheral Identification 1 (WDTPeriphID1), offset 0xFE4**

The **WDTPeriphIDn** registers are hard-coded and the fields within the register determine the reset value.

Watchdog Peripheral Identification 1 (WDTPeriphID1)

Offset 0xFE4



| Bit/Field | Name     | Type | Reset | Description   |
|-----------|----------|------|-------|---|
| 31:8      | reserved | RO   | 0     | Reserved bits return an indeterminate value, and should never be changed. |
| 7:0       | PID1     | RO   | 0x18  | Watchdog Peripheral ID Register[15:8]                                     |

**Register 15: Watchdog Peripheral Identification 2 (WDTPeriphID2), offset 0xFE8**

The **WDTPeriphIDn** registers are hard-coded and the fields within the register determine the reset value.

## Watchdog Peripheral Identification 2 (WDTPeriphID2)

Offset 0xFE8

|       |          |    |    |    |    |    |    |    |      |    |    |    |    |    |    |    |
|-------|----------|----|----|----|----|----|----|----|------|----|----|----|----|----|----|----|
|       | 31       | 30 | 29 | 28 | 27 | 26 | 25 | 24 | 23   | 22 | 21 | 20 | 19 | 18 | 17 | 16 |
|       | reserved |    |    |    |    |    |    |    |      |    |    |    |    |    |    |    |
| Type  | RO       | RO | RO | RO | RO | RO | RO | RO | RO   | RO | RO | RO | RO | RO | RO | RO |
| Reset | 0        | 0  | 0  | 0  | 0  | 0  | 0  | 0  | 0    | 0  | 0  | 0  | 0  | 0  | 0  | 0  |
|       | 15       | 14 | 13 | 12 | 11 | 10 | 9  | 8  | 7    | 6  | 5  | 4  | 3  | 2  | 1  | 0  |
|       | reserved |    |    |    |    |    |    |    | PID2 |    |    |    |    |    |    |    |
| Type  | RO       | RO | RO | RO | RO | RO | RO | RO | RO   | RO | RO | RO | RO | RO | RO | RO |
| Reset | 0        | 0  | 0  | 0  | 0  | 0  | 0  | 0  | 0    | 0  | 0  | 1  | 1  | 0  | 0  | 0  |

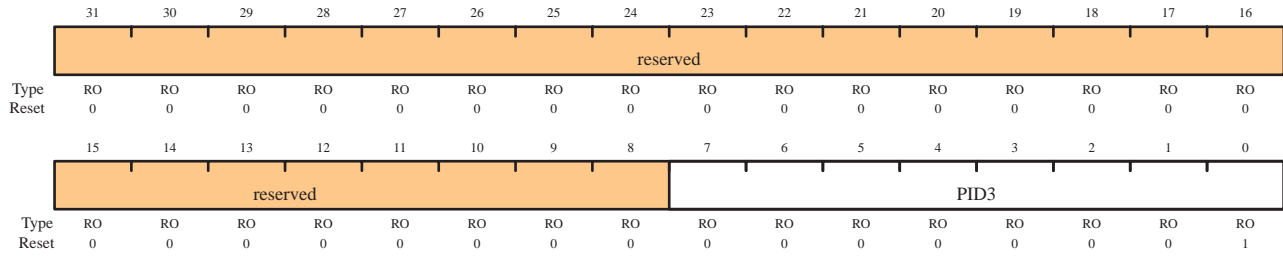
| Bit/Field | Name     | Type | Reset | Description   |
|-----------|----------|------|-------|---|
| 31:8      | reserved | RO   | 0     | Reserved bits return an indeterminate value, and should never be changed. |
| 7:0       | PID2     | RO   | 0x18  | Watchdog Peripheral ID Register[23:16]                                    |

**Register 16: Watchdog Peripheral Identification 3 (WDTPeriphID3), offset 0xFEC**

The **WDTPeriphIDn** registers are hard-coded and the fields within the register determine the reset value.

Watchdog Peripheral Identification 3 (WDTPeriphID3)

Offset 0xFEC



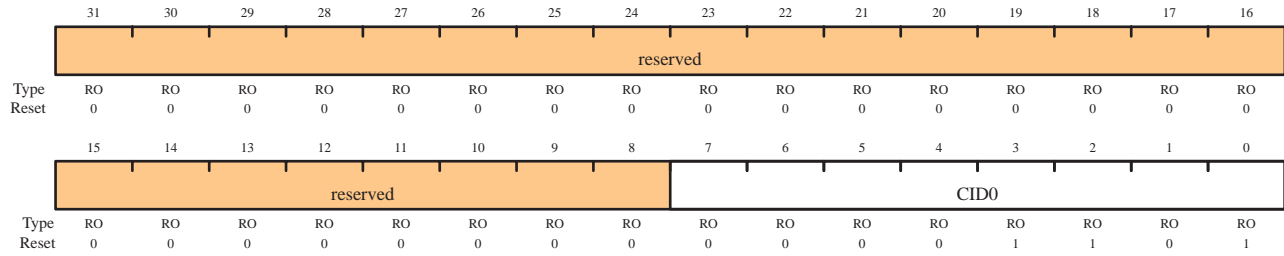
| Bit/Field | Name     | Type | Reset | Description   |
|-----------|----------|------|-------|---|
| 31:8      | reserved | RO   | 0     | Reserved bits return an indeterminate value, and should never be changed. |
| 7:0       | PID3     | RO   | 0x01  | Watchdog Peripheral ID Register[31:24]                                    |

**Register 17: Watchdog PrimeCell Identification 0 (WDTPCellID0), offset 0xFF0**

The **WDTPCellIDn** registers are hard-coded and the fields within the register determine the reset value.

Watchdog Primecell Identification 0 (WDTPCellID0)

Offset 0xFF0



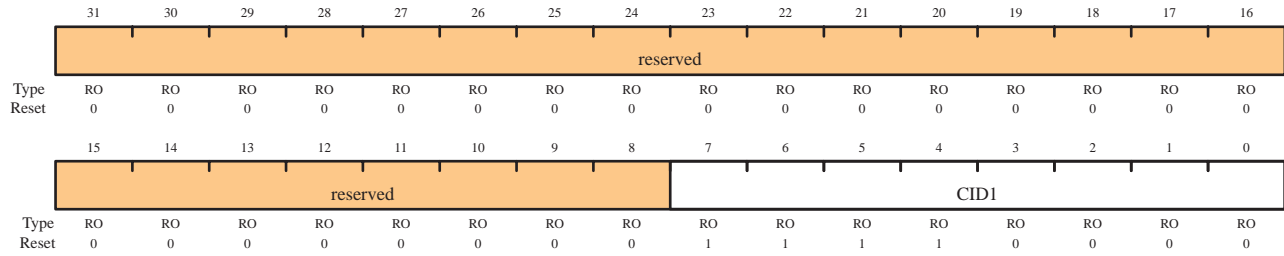
| Bit/Field | Name     | Type | Reset | Description   |
|-----------|----------|------|-------|---|
| 31:8      | reserved | RO   | 0     | Reserved bits return an indeterminate value, and should never be changed. |
| 7:0       | CID0     | RO   | 0x0D  | Watchdog PrimeCell ID Register[7:0]                                       |

**Register 18: Watchdog PrimeCell Identification 1 (WDTPCellID1), offset 0xFF4**

The **WDTPCellIDn** registers are hard-coded and the fields within the register determine the reset value.

Watchdog Primecell Identification 1 (WDTPCellID1)

Offset 0xFF4



| Bit/Field | Name     | Type | Reset | Description   |
|-----------|----------|------|-------|---|
| 31:8      | reserved | RO   | 0     | Reserved bits return an indeterminate value, and should never be changed. |
| 7:0       | CID1     | RO   | 0xF0  | Watchdog PrimeCell ID Register[15:8]                                      |



**Register 19: Watchdog PrimeCell Identification 2 (WDTPCellID2), offset 0xFF8**

The **WDTPCellIDn** registers are hard-coded and the fields within the register determine the reset value.

## Watchdog Primecell Identification 2 (WDTPCellID2)

Offset 0xFF8

|       |          |    |    |    |    |    |    |    |      |    |    |    |    |    |    |    |
|-------|----------|----|----|----|----|----|----|----|------|----|----|----|----|----|----|----|
|       | 31       | 30 | 29 | 28 | 27 | 26 | 25 | 24 | 23   | 22 | 21 | 20 | 19 | 18 | 17 | 16 |
|       | reserved |    |    |    |    |    |    |    |      |    |    |    |    |    |    |    |
| Type  | RO       | RO | RO | RO | RO | RO | RO | RO | RO   | RO | RO | RO | RO | RO | RO | RO |
| Reset | 0        | 0  | 0  | 0  | 0  | 0  | 0  | 0  | 0    | 0  | 0  | 0  | 0  | 0  | 0  | 0  |
|       | 15       | 14 | 13 | 12 | 11 | 10 | 9  | 8  | 7    | 6  | 5  | 4  | 3  | 2  | 1  | 0  |
|       | reserved |    |    |    |    |    |    |    | CID2 |    |    |    |    |    |    |    |
| Type  | RO       | RO | RO | RO | RO | RO | RO | RO | RO   | RO | RO | RO | RO | RO | RO | RO |
| Reset | 0        | 0  | 0  | 0  | 0  | 0  | 0  | 0  | 0    | 0  | 0  | 0  | 0  | 1  | 0  | 1  |

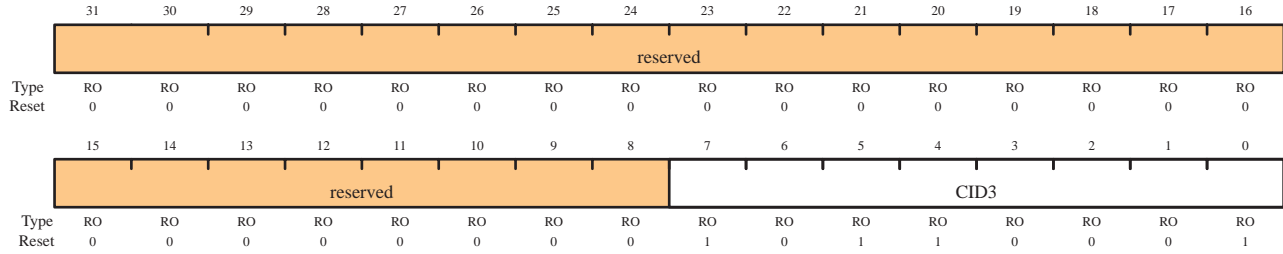
| Bit/Field | Name     | Type | Reset | Description   |
|-----------|----------|------|-------|---|
| 31:8      | reserved | RO   | 0     | Reserved bits return an indeterminate value, and should never be changed. |
| 7:0       | CID2     | RO   | 0x05  | Watchdog PrimeCell ID Register[23:16]                                     |

**Register 20: Watchdog PrimeCell Identification 3 (WDTPCellID3 ), offset 0xFFC**

The **WDTPCellIDn** registers are hard-coded and the fields within the register determine the reset value.

Watchdog Primecell Identification 3 (WDTPCellID3)

Offset 0xFFC



| Bit/Field | Name     | Type | Reset | Description   |
|-----------|----------|------|-------|---|
| 31:8      | reserved | RO   | 0     | Reserved bits return an indeterminate value, and should never be changed. |
| 7:0       | CID3     | RO   | 0xB1  | Watchdog PrimeCell ID Register[31:24]                                     |

## 11 Analog-to-Digital Converter (ADC)

An analog-to-digital converter (ADC) is a peripheral that converts a continuous analog voltage to a discrete digital number.

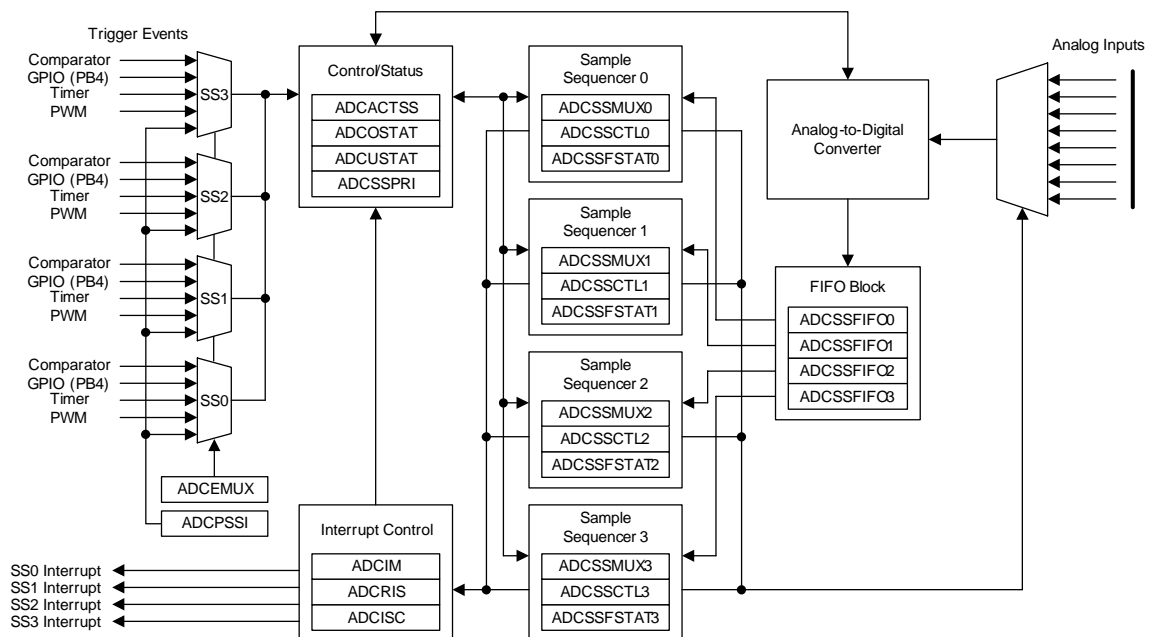
The Stellaris ADC module features 10-bit conversion resolution and supports eight input channels, plus an internal temperature sensor. The ADC module contains a programmable sequencer which allows for the sampling of multiple analog input sources without controller intervention. Each sample sequence provides flexible programming with fully configurable input source, trigger events, interrupt generation, and sequence priority.

The Stellaris ADC provides the following features:

- Eight analog input channels
- Single-ended and differential-input configurations
- Internal temperature sensor
- Sample rate of one million samples/second
- Four programmable sample conversion sequences from one to eight entries long, with corresponding conversion result FIFOs
- Flexible trigger control
  - Controller (software)
  - Timers
  - GPIO
- Hardware averaging of up to 64 samples for improved accuracy

### 11.1 Block Diagram

Figure 11-1. ADC Module Block Diagram



## 11.2 Functional Description

The Stellaris ADC collects sample data by using a programmable sequence-based approach instead of the traditional single or double-sampling approach found on many ADC modules. Each *sample sequence* is a fully programmed series of consecutive (back-to-back) samples, allowing the ADC to collect data from multiple input sources without having to be re-configured or serviced by the controller. The programming of each sample in the sample sequence includes parameters such as the input source and mode (differential versus single-ended input), interrupt generation on sample completion, and the indicator for the last sample in the sequence.

### 11.2.1 Sample Sequencers

The sampling control and data capture is handled by the Sample Sequencers. All of the sequencers are identical in implementation except for the number of samples that can be captured and the depth of the FIFO. Table 11-1 shows the maximum number of samples that each Sequencer can capture and its corresponding FIFO depth. In this implementation, each FIFO entry is a 32-bit word, with the lower 10 bits containing the conversion result.

**Table 11-1. Samples and FIFO Depth of Sequencers**

| Sequencer | Number of Samples | Depth of FIFO |
|-----------|-------------------|---------------|
| SS3       | 1                 | 1             |
| SS2       | 4                 | 4             |
| SS1       | 4                 | 4             |
| SS0       | 8                 | 8             |

For a given sample sequence, each sample is defined by two 4-bit nibbles in the **ADC Sample Sequence Input Multiplexer Select (ADCSSMUXn)** and **ADC Sample Sequence Control (ADCSSCTLn)** registers, where "n" corresponds to the sequence number. The **ADCSSMUXn** nibbles select the input pin, while the **ADCSSCTLn** nibbles contain the sample control bits corresponding to parameters such as temperature sensor selection, interrupt enable, end of sequence, and differential input mode. Sample Sequencers are enabled by setting the respective **ASENn** bit in the **ADC Active Sample Sequencer (ADCACTSS)** register, but can be configured before being enabled.

When configuring a sample sequence, multiple uses of the same input pin within the same sequence is allowed. In the **ADCSSCTLn** register, the **Interrupt Enable (IE)** bits can be set for any combination of samples, allowing interrupts to be generated after every sample in the sequence if necessary. Also, the **END** bit can be set at any point within a sample sequence. For example, if Sequencer 0 is used, the **END** bit can be set in the nibble associated with the fifth sample, allowing Sequencer 0 to complete execution of the sample sequence after the fifth sample.

After a sample sequence completes execution, the result data can be retrieved from the **ADC Sample Sequence Result FIFO (ADCSSFIFO)** registers. The FIFOs are simple circular buffers that read a single address to "pop" result data. For software debug purposes, the positions of the FIFO head and tail pointers are visible in the **ADC Sample Sequence FIFO Status (ADCSSFSTATn)** registers along with **FULL** and **EMPTY** status flags. Overflow and underflow conditions are monitored using the **ADCOSTAT** and **ADCUSTAT** registers.

## 11.2.2 Module Control

Outside of the Sample Sequencers, the remainder of the control logic is responsible for tasks such as interrupt generation, sequence prioritization, and trigger configuration.

Most of the ADC control logic runs at the ADC clock rate of 14-18 MHz. The internal ADC divider is configured automatically by hardware when the system XTAL is selected. The automatic clock divider configuration targets 16.667 MHz operation for all Stellaris devices.

### 11.2.2.1 Interrupts

The Sample Sequencers dictate the events that cause interrupts, but they don't have control over whether the interrupt is actually sent to the interrupt controller. The ADC module's interrupt signal is controlled by the state of the MASK bits in the **ADC Interrupt Mask (ADCIM)** register. Interrupt status can be viewed at two locations: the **ADC Raw Interrupt Status (ADCRIS)** register, which shows the raw status of a Sample Sequencer's interrupt signal, and the **ADC Interrupt Status and Clear (ADCISC)** register, which shows the logical AND of the ADCRIS register's INR bit and the ADCIM register's MASK bits. Interrupts are cleared by writing a 1 to the corresponding IN bit in ADCISC.

### 11.2.2.2 Prioritization

When sampling events (triggers) happen concurrently, they are prioritized for processing by the values in the **ADC Sample Sequencer Priority (ADCSSPRI)** register. Valid priority values are in the range of 0-3, with 0 being the highest priority and 3 being the lowest. Multiple active Sample Sequencer units with the same priority do not provide consistent results, so software must ensure that all active Sample Sequencer units have a unique priority value.

### 11.2.2.3 Sampling Events

Sample triggering for each Sample Sequencer is defined in the **ADC Event Multiplexer Select (ADCEMUX)** register. The external peripheral triggering sources vary by Stellaris family member, but all devices share the "Controller" and "Always" triggers. Software can initiate sampling by setting the CH bits in the **ADC Processor Sample Sequence Initiate (ADCPSSI)** register.

When using the "Always" trigger, care must be taken. If a sequence's priority is too high, it is possible to starve other lower priority sequences.

## 11.2.3 Hardware Sample Averaging Circuit

Higher precision results can be generated using the hardware averaging circuit, however, the improved results are at the cost of throughput. Up to 64 samples can be accumulated and averaged to form a single data entry in the sequencer FIFO. Throughput is decreased proportionally to the number of samples in the averaging calculation. For example, if the averaging circuit is configured to average 16 samples, the throughput is decreased by a factor of 16.

By default the averaging circuit is off and all data from the converter passes through to the sequencer FIFO. The averaging hardware is controlled by the **ADC Sample Averaging Control (ADC SAC)** register (see page 210). There is a single averaging circuit and all input channels receive the same amount of averaging whether they are single-ended or differential.

## 11.2.4 Analog-to-Digital Converter

The converter itself generates a 10-bit output value for selected analog input. Special analog pads are used to minimize the distortion on the input.

## 11.2.5 Test Modes

There is a user-available test mode that allows for loopback operation within the digital portion of the ADC module. This can be useful for debugging software without having to provide actual

analog stimulus. This mode is available through the **ADC Test Mode Loopback (ADCTMLB)** register (see page 223).

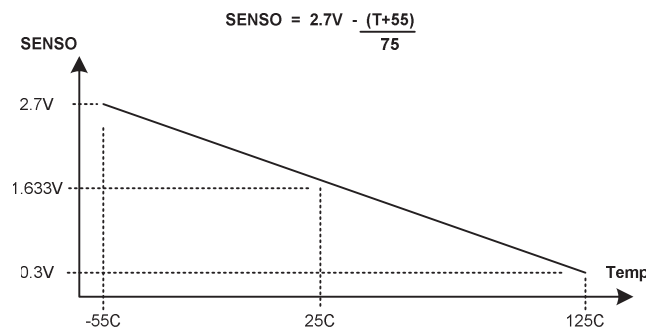
### 11.2.6 Internal Temperature Sensor

The internal temperature sensor provides an analog temperature reading as well as a reference voltage. The voltage at the output terminal **SENSO** is given by the following equation:

$$SENSO = 2.7 - ((T + 55) / 75)$$

This relation is shown in Figure 11-2 on page 198.

**Figure 11-2. Internal Temperature Sensor Characteristic**



## 11.3 Initialization and Configuration

In order for the ADC module to be used, the PLL must be enabled and using a supported crystal frequency (see the **RCC** register on page 75). Using unsupported frequencies can cause faulty operation in the ADC module.

### 11.3.1 Module Initialization

Initialization of the ADC module is a simple process with very few steps. The main steps include enabling the clock to the ADC and reconfiguring the Sample Sequencer priorities (if needed).

The initialization sequence for the ADC is as follows:

1. Enable the ADC clock by writing a value of 0x00010000 to the **RCGC1** register in the System Control module.
2. If required by the application, reconfigure the Sample Sequencer priorities in the **ADCSSPRI** register. The default configuration has Sample Sequencer 0 with the highest priority, and Sample Sequencer 3 as the lowest priority.

### 11.3.2 Sample Sequencer Configuration

Configuration of the Sample Sequencers is slightly more complex than the module initialization since each sample sequence is completely programmable.

The configuration for each Sample Sequencer should be as follows:

1. Ensure that the Sample Sequencer is disabled by writing a 0 to the corresponding **ASEN** bit in the **ADCACTSS** register. Programming of the Sample Sequencers is allowed without having them enabled. Disabling the Sequencer during programming prevents erroneous execution if a trigger event were to occur during the configuration process.
2. Configure the trigger event for the Sample Sequencer in the **ADCEMUX** register.

3. For each sample in the sample sequence, configure the corresponding input source in the **ADCSSMUXn** register.
4. For each sample in the sample sequence, configure the sample control bits in the corresponding nibble in the **ADCSSCTLn** register. When programming the last nibble, ensure that the **END** bit is set. Failure to set the **END** bit causes unpredictable behavior.
5. If interrupts are to be used, write a 1 to the corresponding **MASK** bit in the **ADCIM** register.
6. Enable the Sample Sequencer logic by writing a 1 to the corresponding **ASEN** bit in the **ADCACTSS** register.

## 11.4 Register Map

Table 11-2 lists the ADC registers. The offset listed is a hexadecimal increment to the register's address, relative to the ADC base address of 0x40038000.

**Table 11-2. ADC Register Map**

| Offset | Name        | Reset      | Type  | Description                                | See page |
|--------|-------------|------------|-------|--|----------|
| 0x000  | ADCACTSS    | 0x00000000 | R/W   | Active sample sequencer                    | 201      |
| 0x004  | ADCRIS      | 0x00000000 | RO    | Raw interrupt status and clear             | 202      |
| 0x008  | ADCIM       | 0x00000000 | R/W   | Interrupt mask                             | 203      |
| 0x00C  | ADCISC      | 0x00000000 | R/W1C | Interrupt status and clear                 | 204      |
| 0x010  | ADCOSTAT    | 0x00000000 | R/W1C | Overflow status                            | 205      |
| 0x014  | ADCEMUX     | 0x00000000 | R/W   | Event multiplexer select                   | 206      |
| 0x018  | ADCUSTAT    | 0x00000000 | R/W1C | Underflow status                           | 207      |
| 0x020  | ADCSSPRI    | 0x00003210 | R/W   | Sample sequencer priority                  | 208      |
| 0x028  | ADCPSSI     | -          | WO    | Processor sample sequence initiate         | 209      |
| 0x030  | ADCSCAC     | 0x00000000 | R/W   | Sample averaging control                   | 210      |
| 0x040  | ADCSSMUX0   | 0x00000000 | R/W   | Sample sequence input multiplexer select 0 | 211      |
| 0x044  | ADCSSCTL0   | 0x00000000 | R/W   | Sample sequence control 0                  | 213      |
| 0x048  | ADCSSFIFO0  | 0x00000000 | RO    | Sample sequence result FIFO 0              | 215      |
| 0x04C  | ADCSSFSTAT0 | 0x00000100 | RO    | Sample sequence FIFO 0 status              | 216      |
| 0x060  | ADCSSMUX1   | 0x00000000 | R/W   | Sample sequence input multiplexer select 1 | 217      |
| 0x064  | ADCSSCTL1   | 0x00000000 | R/W   | Sample sequence control 1                  | 218      |
| 0x068  | ADCSSFIFO1  | 0x00000000 | RO    | Sample sequence result FIFO 1              | 218      |
| 0x06C  | ADCSSFSTAT1 | 0x00000100 | RO    | Sample sequence FIFO 1 status              | 218      |
| 0x080  | ADCSSMUX2   | 0x00000000 | R/W   | Sample sequence input multiplexer select 2 | 219      |
| 0x084  | ADCSSCTL2   | 0x00000000 | R/W   | Sample sequence control 2                  | 220      |
| 0x088  | ADCSSFIFO2  | 0x00000000 | RO    | Sample sequence result FIFO 2              | 220      |

**Table 11-2. ADC Register Map (Continued)**

| Offset | Name        | Reset      | Type | Description                                | See page |
|--------|-------------|------------|------|--|----------|
| 0x08C  | ADCSSFSTAT2 | 0x00000100 | RO   | Sample sequence FIFO 2 status              | 220      |
| 0x0A0  | ADCSSMUX3   | 0x00000000 | R/W  | Sample sequence input multiplexer select 3 | 221      |
| 0x064  | ADCSSCTL3   | 0x00000002 | R/W  | Sample sequence control 3                  | 222      |
| 0x0A8  | ADCSSFIFO3  | 0x00000000 | RO   | Sample sequence result FIFO 3              | 222      |
| 0x0AC  | ADCSSFSTAT3 | 0x00000100 | RO   | Sample sequence FIFO 3 status              | 222      |
| 0x100  | ADCTMLB     | 0x00000000 | R/W  | Test mode loopback                         | 223      |

## 11.5 Register Descriptions

The remainder of this section lists and describes the ADC registers, in numerical order by address offset.



**Register 1: ADC Active Sample Sequencer (ADCACTSS), offset 0x000**

This register controls the activation of the Sample Sequencers. Each Sample Sequencer can be enabled/disabled independently.

## ADC Active Sample Sequencer (ADCACTSS)

Offset 0x000

|       |          |    |    |    |    |    |    |    |    |    |    |    |       |       |       |       |
|-------|----------|----|----|----|----|----|----|----|----|----|----|----|-------|-------|-------|-------|
|       | 31       | 30 | 29 | 28 | 27 | 26 | 25 | 24 | 23 | 22 | 21 | 20 | 19    | 18    | 17    | 16    |
|       | reserved |    |    |    |    |    |    |    |    |    |    |    |       |       |       |       |
| Type  | RO       | RO | RO | RO | RO | RO | RO | RO | RO | RO | RO | RO | RO    | RO    | RO    | RO    |
| Reset | 0        | 0  | 0  | 0  | 0  | 0  | 0  | 0  | 0  | 0  | 0  | 0  | 0     | 0     | 0     | 0     |
|       | 15       | 14 | 13 | 12 | 11 | 10 | 9  | 8  | 7  | 6  | 5  | 4  | 3     | 2     | 1     | 0     |
|       | reserved |    |    |    |    |    |    |    |    |    |    |    | ASEN3 | ASEN2 | ASEN1 | ASEN0 |
| Type  | RO       | RO | RO | RO | RO | RO | RO | RO | RO | RO | RO | RO | R/W   | R/W   | R/W   | R/W   |
| Reset | 0        | 0  | 0  | 0  | 0  | 0  | 0  | 0  | 0  | 0  | 0  | 0  | 0     | 0     | 0     | 0     |

| Bit/Field | Name     | Type | Reset | Description   |
|-----------|----------|------|-------|---|
| 31:4      | reserved | RO   | 0     | Reserved bits return an indeterminate value, and should never be changed.   |
| 3         | ASEN3    | R/W  | 0     | Specifies whether Sample Sequencer 3 is enabled. If set, the sample sequence logic for Sequencer 3 is active. Otherwise, the Sequencer is inactive. |
| 2         | ASEN2    | R/W  | 0     | Specifies whether Sample Sequencer 2 is enabled. If set, the sample sequence logic for Sequencer 2 is active. Otherwise, the Sequencer is inactive. |
| 1         | ASEN1    | R/W  | 0     | Specifies whether Sample Sequencer 1 is enabled. If set, the sample sequence logic for Sequencer 1 is active. Otherwise, the Sequencer is inactive. |
| 0         | ASEN0    | R/W  | 0     | Specifies whether Sample Sequencer 0 is enabled. If set, the sample sequence logic for Sequencer 0 is active. Otherwise, the Sequencer is inactive. |

**Register 2: ADC Raw Interrupt Status (ADCRIS), offset 0x004**

This register shows the status of the raw interrupt signal of each Sample Sequencer. These bits may be polled by software to look for interrupt conditions without having to generate controller interrupts.

ADC Raw Interrupt Status (ADCRIS)

Offset 0x004

|       |          |    |    |    |    |    |    |    |    |    |    |    |      |      |      |      |
|-------|----------|----|----|----|----|----|----|----|----|----|----|----|------|------|------|------|
|       | 31       | 30 | 29 | 28 | 27 | 26 | 25 | 24 | 23 | 22 | 21 | 20 | 19   | 18   | 17   | 16   |
|       | reserved |    |    |    |    |    |    |    |    |    |    |    |      |      |      |      |
| Type  | RO       | RO | RO | RO | RO | RO | RO | RO | RO | RO | RO | RO | RO   | RO   | RO   | RO   |
| Reset | 0        | 0  | 0  | 0  | 0  | 0  | 0  | 0  | 0  | 0  | 0  | 0  | 0    | 0    | 0    | 0    |
|       | 15       | 14 | 13 | 12 | 11 | 10 | 9  | 8  | 7  | 6  | 5  | 4  | 3    | 2    | 1    | 0    |
|       | reserved |    |    |    |    |    |    |    |    |    |    |    | INR3 | INR2 | INR1 | INR0 |
| Type  | RO       | RO | RO | RO | RO | RO | RO | RO | RO | RO | RO | RO | RO   | RO   | RO   | RO   |
| Reset | 0        | 0  | 0  | 0  | 0  | 0  | 0  | 0  | 0  | 0  | 0  | 0  | 0    | 0    | 0    | 0    |

| Bit/Field | Name     | Type | Reset | Description  |
|-----------|----------|------|-------|--|
| 31:4      | reserved | RO   | 0     | Reserved bits return an indeterminate value, and should never be changed.  |
| 3         | INR3     | RO   | 0     | Set by hardware when a sample with its respective <b>ADCSSCTL3</b> IE bit has completed conversion. This bit is cleared by writing a 1 to the <b>ADCISC</b> IN3 bit. |
| 2         | INR2     | RO   | 0     | Set by hardware when a sample with its respective <b>ADCSSCTL2</b> IE bit has completed conversion. This bit is cleared by writing a 1 to the <b>ADCISC</b> IN2 bit. |
| 1         | INR1     | RO   | 0     | Set by hardware when a sample with its respective <b>ADCSSCTL1</b> IE bit has completed conversion. This bit is cleared by writing a 1 to the <b>ADCISC</b> IN1 bit. |
| 0         | INR0     | RO   | 0     | Set by hardware when a sample with its respective <b>ADCSSCTL0</b> IE bit has completed conversion. This bit is cleared by writing a 1 to the <b>ADCISC</b> IN0 bit. |

**Register 3: ADC Interrupt Mask (ADCIM), offset 0x008**

This register controls whether the Sample Sequencer raw interrupt signals are promoted to controller interrupts. The raw interrupt signal for each Sample Sequencer can be masked independently.

## ADC Interrupt Mask (ADCIM)

Offset 0x008

|       |          |    |    |    |    |    |    |    |    |    |    |    |       |       |       |       |
|-------|----------|----|----|----|----|----|----|----|----|----|----|----|-------|-------|-------|-------|
|       | 31       | 30 | 29 | 28 | 27 | 26 | 25 | 24 | 23 | 22 | 21 | 20 | 19    | 18    | 17    | 16    |
|       | reserved |    |    |    |    |    |    |    |    |    |    |    |       |       |       |       |
| Type  | RO       | RO | RO | RO | RO | RO | RO | RO | RO | RO | RO | RO | RO    | RO    | RO    | RO    |
| Reset | 0        | 0  | 0  | 0  | 0  | 0  | 0  | 0  | 0  | 0  | 0  | 0  | 0     | 0     | 0     | 0     |
|       | 15       | 14 | 13 | 12 | 11 | 10 | 9  | 8  | 7  | 6  | 5  | 4  | 3     | 2     | 1     | 0     |
|       | reserved |    |    |    |    |    |    |    |    |    |    |    | MASK3 | MASK2 | MASK1 | MASK0 |
| Type  | RO       | RO | RO | RO | RO | RO | RO | RO | RO | RO | RO | RO | R/W   | R/W   | R/W   | R/W   |
| Reset | 0        | 0  | 0  | 0  | 0  | 0  | 0  | 0  | 0  | 0  | 0  | 0  | 0     | 0     | 0     | 0     |

| Bit/Field | Name     | Type | Reset | Description   |
|-----------|----------|------|-------|---|
| 31:4      | reserved | RO   | 0     | Reserved bits return an indeterminate value, and should never be changed.   |
| 3         | MASK3    | R/W  | 0     | Specifies whether the raw interrupt signal from Sample Sequencer 3 ( <b>ADCRIS</b> register <i>INR3</i> bit) is promoted to a controller interrupt. If set, the raw interrupt signal is promoted to a controller interrupt. Otherwise, it is not. |
| 2         | MASK2    | R/W  | 0     | Specifies whether the raw interrupt signal from Sample Sequencer 2 ( <b>ADCRIS</b> register <i>INR2</i> bit) is promoted to a controller interrupt. If set, the raw interrupt signal is promoted to a controller interrupt. Otherwise, it is not. |
| 1         | MASK1    | R/W  | 0     | Specifies whether the raw interrupt signal from Sample Sequencer 1 ( <b>ADCRIS</b> register <i>INR0</i> bit) is promoted to a controller interrupt. If set, the raw interrupt signal is promoted to a controller interrupt. Otherwise, it is not. |
| 0         | MASK0    | R/W  | 0     | Specifies whether the raw interrupt signal from Sample Sequencer 0 ( <b>ADCRIS</b> register <i>INR0</i> bit) is promoted to a controller interrupt. If set, the raw interrupt signal is promoted to a controller interrupt. Otherwise, it is not. |

**Register 4: ADC Interrupt Status and Clear (ADCISC), offset 0x00C**

This register provides the mechanism for clearing interrupt conditions, and shows the status of controller interrupts generated by the Sample Sequencers. When read, each bit field is the logical AND of the respective *INR* and *MASK* bits. Interrupts are cleared by writing a 1 to the corresponding bit position. If software is polling the **ADCRIS** instead of generating interrupts, the *INR* bits are still cleared via the **ADCISC** register, even if the *IN* bit is not set.

ADC Interrupt Status and Clear (ADCISC)

Offset 0x00C

|       |          |    |    |    |    |    |    |    |    |    |    |    |       |       |       |       |
|-------|----------|----|----|----|----|----|----|----|----|----|----|----|-------|-------|-------|-------|
|       | 31       | 30 | 29 | 28 | 27 | 26 | 25 | 24 | 23 | 22 | 21 | 20 | 19    | 18    | 17    | 16    |
|       | reserved |    |    |    |    |    |    |    |    |    |    |    |       |       |       |       |
| Type  | RO       | RO | RO | RO | RO | RO | RO | RO | RO | RO | RO | RO | RO    | RO    | RO    | RO    |
| Reset | 0        | 0  | 0  | 0  | 0  | 0  | 0  | 0  | 0  | 0  | 0  | 0  | 0     | 0     | 0     | 0     |
|       | 15       | 14 | 13 | 12 | 11 | 10 | 9  | 8  | 7  | 6  | 5  | 4  | 3     | 2     | 1     | 0     |
|       | reserved |    |    |    |    |    |    |    |    |    |    |    | IN3   | IN2   | IN1   | IN0   |
| Type  | RO       | RO | RO | RO | RO | RO | RO | RO | RO | RO | RO | RO | R/W1C | R/W1C | R/W1C | R/W1C |
| Reset | 0        | 0  | 0  | 0  | 0  | 0  | 0  | 0  | 0  | 0  | 0  | 0  | 0     | 0     | 0     | 0     |

| Bit/Field | Name     | Type  | Reset | Description  |
|-----------|----------|-------|-------|--|
| 31:4      | reserved | RO    | 0     | Reserved bits return an indeterminate value, and should never be changed.  |
| 3         | IN3      | R/W1C | 0     | This bit is set by hardware when the <i>MASK3</i> and <i>INR3</i> bits are both 1, providing a level-based interrupt to the controller. It is cleared by writing a 1, and also clears the <i>INR3</i> bit. |
| 2         | IN2      | R/W1C | 0     | This bit is set by hardware when the <i>MASK2</i> and <i>INR2</i> bits are both 1, providing a level based interrupt to the controller. It is cleared by writing a 1, and also clears the <i>INR2</i> bit. |
| 1         | IN1      | R/W1C | 0     | This bit is set by hardware when the <i>MASK1</i> and <i>INR1</i> bits are both 1, providing a level based interrupt to the controller. It is cleared by writing a 1, and also clears the <i>INR1</i> bit. |
| 0         | IN0      | R/W1C | 0     | This bit is set by hardware when the <i>MASK0</i> and <i>INR0</i> bits are both 1, providing a level based interrupt to the controller. It is cleared by writing a 1, and also clears the <i>INR0</i> bit. |

**Register 5: ADC Overflow Status (ADCOSTAT), offset 0x010**

This register indicates overflow conditions in the Sample Sequencer FIFOs. Once the overflow condition has been handled by software, the condition can be cleared by writing a 1 to the corresponding bit position.

## ADC Overflow Status (ADCOSTAT)

Offset 0x010

|       |          |    |    |    |    |    |    |    |    |    |    |    |       |       |       |       |
|-------|----------|----|----|----|----|----|----|----|----|----|----|----|-------|-------|-------|-------|
|       | 31       | 30 | 29 | 28 | 27 | 26 | 25 | 24 | 23 | 22 | 21 | 20 | 19    | 18    | 17    | 16    |
|       | reserved |    |    |    |    |    |    |    |    |    |    |    |       |       |       |       |
| Type  | RO       | RO | RO | RO | RO | RO | RO | RO | RO | RO | RO | RO | RO    | RO    | RO    | RO    |
| Reset | 0        | 0  | 0  | 0  | 0  | 0  | 0  | 0  | 0  | 0  | 0  | 0  | 0     | 0     | 0     | 0     |
|       | 15       | 14 | 13 | 12 | 11 | 10 | 9  | 8  | 7  | 6  | 5  | 4  | 3     | 2     | 1     | 0     |
|       | reserved |    |    |    |    |    |    |    |    |    |    |    | OV3   | OV2   | OV1   | OV0   |
| Type  | RO       | RO | RO | RO | RO | RO | RO | RO | RO | RO | RO | RO | R/W1C | R/W1C | R/W1C | R/W1C |
| Reset | 0        | 0  | 0  | 0  | 0  | 0  | 0  | 0  | 0  | 0  | 0  | 0  | 0     | 0     | 0     | 0     |

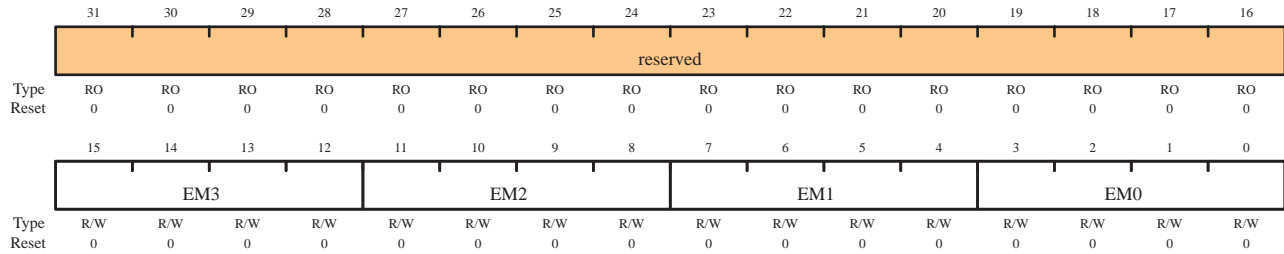
| Bit/Field | Name     | Type  | Reset | Description  |
|-----------|----------|-------|-------|--|
| 31:4      | reserved | RO    | 0     | Reserved bits return an indeterminate value, and should never be changed.  |
| 3         | OV3      | R/W1C | 0     | This bit specifies that the FIFO for Sample Sequencer 3 has hit an overflow condition where the FIFO is full and a write was requested. When an overflow is detected, the most recent write is dropped and this bit is set by hardware to indicate the occurrence of dropped data. This bit is cleared by writing a 1. |
| 2         | OV2      | R/W1C | 0     | This bit specifies that the FIFO for Sample Sequencer 2 has hit an overflow condition where the FIFO is full and a write was requested. When an overflow is detected, the most recent write is dropped and this bit is set by hardware to indicate the occurrence of dropped data. This bit is cleared by writing a 1. |
| 1         | OV1      | R/W1C | 0     | This bit specifies that the FIFO for Sample Sequencer 1 has hit an overflow condition where the FIFO is full and a write was requested. When an overflow is detected, the most recent write is dropped and this bit is set by hardware to indicate the occurrence of dropped data. This bit is cleared by writing a 1. |
| 0         | OV0      | R/W1C | 0     | This bit specifies that the FIFO for Sample Sequencer 0 has hit an overflow condition where the FIFO is full and a write was requested. When an overflow is detected, the most recent write is dropped and this bit is set by hardware to indicate the occurrence of dropped data. This bit is cleared by writing a 1. |

**Register 6: ADC Event Multiplexer Select (ADCEMUX), offset 0x014**

The **ADCEMUX** selects the event (trigger) that initiates sampling for each Sample Sequencer. Each Sample Sequencer can be configured with a unique trigger source.

ADC Event Multiplexer Select (ADCEMUX)

Offset 0x014



| Bit/Field       | Name                         | Type | Reset | Description  |                 |       |      |                      |      |          |      |          |      |          |      |                     |      |       |      |          |      |          |      |          |           |          |      |                              |
|-----------------|------------------------------|------|-------|--|-----------------|-------|------|----------------------|------|----------|------|----------|------|----------|------|---------------------|------|-------|------|----------|------|----------|------|----------|-----------|----------|------|------------------------------|
| 31:16           | reserved                     | RO   | 0     | Reserved bits return an indeterminate value, and should never be changed.  |                 |       |      |                      |      |          |      |          |      |          |      |                     |      |       |      |          |      |          |      |          |           |          |      |                              |
| 15:12           | EM3                          | R/W  | 0     | This field selects the trigger source for Sample Sequencer 3.<br>The valid configurations for this field are: <table border="1" style="margin-left: 20px;"> <thead> <tr> <th>EM Binary Value</th> <th>Event</th> </tr> </thead> <tbody> <tr><td>0000</td><td>Controller (default)</td></tr> <tr><td>0001</td><td>Reserved</td></tr> <tr><td>0010</td><td>Reserved</td></tr> <tr><td>0011</td><td>Reserved</td></tr> <tr><td>0100</td><td>External (GPIO PB4)</td></tr> <tr><td>0101</td><td>Timer</td></tr> <tr><td>0110</td><td>Reserved</td></tr> <tr><td>0111</td><td>Reserved</td></tr> <tr><td>1000</td><td>Reserved</td></tr> <tr><td>1001-1110</td><td>reserved</td></tr> <tr><td>1111</td><td>Always (continuously sample)</td></tr> </tbody> </table> | EM Binary Value | Event | 0000 | Controller (default) | 0001 | Reserved | 0010 | Reserved | 0011 | Reserved | 0100 | External (GPIO PB4) | 0101 | Timer | 0110 | Reserved | 0111 | Reserved | 1000 | Reserved | 1001-1110 | reserved | 1111 | Always (continuously sample) |
| EM Binary Value | Event                        |      |       |  |                 |       |      |                      |      |          |      |          |      |          |      |                     |      |       |      |          |      |          |      |          |           |          |      |                              |
| 0000            | Controller (default)         |      |       |  |                 |       |      |                      |      |          |      |          |      |          |      |                     |      |       |      |          |      |          |      |          |           |          |      |                              |
| 0001            | Reserved                     |      |       |  |                 |       |      |                      |      |          |      |          |      |          |      |                     |      |       |      |          |      |          |      |          |           |          |      |                              |
| 0010            | Reserved                     |      |       |  |                 |       |      |                      |      |          |      |          |      |          |      |                     |      |       |      |          |      |          |      |          |           |          |      |                              |
| 0011            | Reserved                     |      |       |  |                 |       |      |                      |      |          |      |          |      |          |      |                     |      |       |      |          |      |          |      |          |           |          |      |                              |
| 0100            | External (GPIO PB4)          |      |       |  |                 |       |      |                      |      |          |      |          |      |          |      |                     |      |       |      |          |      |          |      |          |           |          |      |                              |
| 0101            | Timer                        |      |       |  |                 |       |      |                      |      |          |      |          |      |          |      |                     |      |       |      |          |      |          |      |          |           |          |      |                              |
| 0110            | Reserved                     |      |       |  |                 |       |      |                      |      |          |      |          |      |          |      |                     |      |       |      |          |      |          |      |          |           |          |      |                              |
| 0111            | Reserved                     |      |       |  |                 |       |      |                      |      |          |      |          |      |          |      |                     |      |       |      |          |      |          |      |          |           |          |      |                              |
| 1000            | Reserved                     |      |       |  |                 |       |      |                      |      |          |      |          |      |          |      |                     |      |       |      |          |      |          |      |          |           |          |      |                              |
| 1001-1110       | reserved                     |      |       |  |                 |       |      |                      |      |          |      |          |      |          |      |                     |      |       |      |          |      |          |      |          |           |          |      |                              |
| 1111            | Always (continuously sample) |      |       |  |                 |       |      |                      |      |          |      |          |      |          |      |                     |      |       |      |          |      |          |      |          |           |          |      |                              |
| 11:8            | EM2                          | R/W  | 0     | This field selects the trigger source for Sample Sequencer 2. The encodings are the same as those for EM3.   |                 |       |      |                      |      |          |      |          |      |          |      |                     |      |       |      |          |      |          |      |          |           |          |      |                              |
| 7:4             | EM1                          | R/W  | 0     | This field selects the trigger source for Sample Sequencer 1. The encodings are the same as those for EM3.   |                 |       |      |                      |      |          |      |          |      |          |      |                     |      |       |      |          |      |          |      |          |           |          |      |                              |
| 3:0             | EM0                          | R/W  | 0     | This field selects the trigger source for Sample Sequencer 0. The encodings are the same as those for EM3.   |                 |       |      |                      |      |          |      |          |      |          |      |                     |      |       |      |          |      |          |      |          |           |          |      |                              |

**Register 7: ADC Underflow Status (ADCUSTAT), offset 0x018**

This register indicates underflow conditions in the Sample Sequencer FIFOs. The corresponding underflow condition can be cleared by writing a 1 to the relevant bit position.

## ADC Underflow Status (ADCUSTAT)

Offset 0x010

|       |          |    |    |    |    |    |    |    |    |    |    |    |       |       |       |       |
|-------|----------|----|----|----|----|----|----|----|----|----|----|----|-------|-------|-------|-------|
|       | 31       | 30 | 29 | 28 | 27 | 26 | 25 | 24 | 23 | 22 | 21 | 20 | 19    | 18    | 17    | 16    |
|       | reserved |    |    |    |    |    |    |    |    |    |    |    |       |       |       |       |
| Type  | RO       | RO | RO | RO | RO | RO | RO | RO | RO | RO | RO | RO | RO    | RO    | RO    | RO    |
| Reset | 0        | 0  | 0  | 0  | 0  | 0  | 0  | 0  | 0  | 0  | 0  | 0  | 0     | 0     | 0     | 0     |
|       | 15       | 14 | 13 | 12 | 11 | 10 | 9  | 8  | 7  | 6  | 5  | 4  | 3     | 2     | 1     | 0     |
|       | reserved |    |    |    |    |    |    |    |    |    |    |    | UV3   | UV2   | UV1   | UV0   |
| Type  | RO       | RO | RO | RO | RO | RO | RO | RO | RO | RO | RO | RO | R/W1C | R/W1C | R/W1C | R/W1C |
| Reset | 0        | 0  | 0  | 0  | 0  | 0  | 0  | 0  | 0  | 0  | 0  | 0  | 0     | 0     | 0     | 0     |

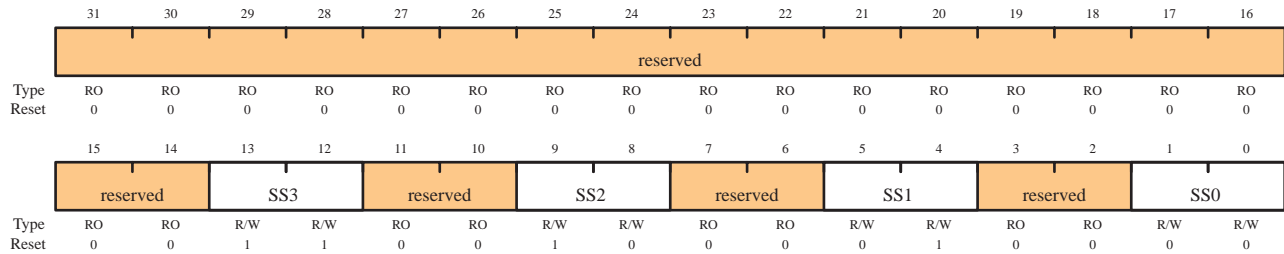
| Bit/Field | Name     | Type  | Reset | Description   |
|-----------|----------|-------|-------|---|
| 31:4      | reserved | RO    | 0     | Reserved bits return an indeterminate value, and should never be changed.   |
| 3         | UV3      | R/W1C | 0     | This bit specifies that the FIFO for Sample Sequencer 3 has hit an underflow condition where the FIFO is empty and a read was requested. The problematic read does not move the FIFO pointers, and 0s are returned. This bit is cleared by writing a 1. |
| 2         | UV2      | R/W1C | 0     | This bit specifies that the FIFO for Sample Sequencer 2 has hit an underflow condition where the FIFO is empty and a read was requested. The problematic read does not move the FIFO pointers, and 0s are returned. This bit is cleared by writing a 1. |
| 1         | UV1      | R/W1C | 0     | This bit specifies that the FIFO for Sample Sequencer 1 has hit an underflow condition where the FIFO is empty and a read was requested. The problematic read does not move the FIFO pointers, and 0s are returned. This bit is cleared by writing a 1. |
| 0         | UV0      | R/W1C | 0     | This bit specifies that the FIFO for Sample Sequencer 0 has hit an underflow condition where the FIFO is empty and a read was requested. The problematic read does not move the FIFO pointers, and 0s are returned. This bit is cleared by writing a 1. |

**Register 8: ADC Sample Sequencer Priority (ADCSSPRI), offset 0x020**

This register sets the priority for each of the Sample Sequencers. Out of reset, Sequencer 0 has the highest priority, and sample sequence 3 has the lowest priority. When reconfiguring sequence priorities, each sequence must have a unique priority or the ADC behavior is inconsistent.

ADC Sample Sequencer Priority (ADCSSPRI)

Offset 0x020



| Bit/Field | Name     | Type | Reset | Description   |
|-----------|----------|------|-------|---|
| 31:14     | reserved | RO   | 0     | Reserved bits return an indeterminate value, and should never be changed.   |
| 13:12     | SS3      | R/W  | 0x3   | The SS3 field contains a binary-encoded value that specifies the priority encoding of Sample Sequencer 3. A priority encoding of 0 is highest and 3 is lowest. The priorities assigned to the Sequencers must be uniquely mapped. ADC behavior is not consistent if two or more fields are equal. |
| 11:10     | reserved | RO   | 0     | Reserved bits return an indeterminate value, and should never be changed.   |
| 9:8       | SS2      | R/W  | 0x2   | The SS2 field contains a binary-encoded value that specifies the priority encoding of Sample Sequencer 2.   |
| 7:6       | reserved | RO   | 0     | Reserved bits return an indeterminate value, and should never be changed.   |
| 5:4       | SS1      | R/W  | 0x1   | The SS1 field contains a binary-encoded value that specifies the priority encoding of Sample Sequencer 1.   |
| 3:2       | reserved | RO   | 0     | Reserved bits return an indeterminate value, and should never be changed.   |
| 1:0       | SS0      | R/W  | 0x0   | The SS0 field contains a binary-encoded value that specifies the priority encoding of Sample Sequencer 0.   |



**Register 9: ADC Processor Sample Sequence Initiate (ADCPSSI), offset 0x028**

This register provides a mechanism for application software to initiate sampling in the Sample Sequencers. Sample sequences can be initiated individually or in any combination. When multiple sequences are triggered simultaneously, the priority encodings in **ADCSSPRI** dictate execution order.

## ADC Processor Sample Sequence Initiate (ADCPSSI)

Offset 0x028

|       |          |    |    |    |    |    |    |    |    |    |    |    |     |     |     |     |
|-------|----------|----|----|----|----|----|----|----|----|----|----|----|-----|-----|-----|-----|
|       | 31       | 30 | 29 | 28 | 27 | 26 | 25 | 24 | 23 | 22 | 21 | 20 | 19  | 18  | 17  | 16  |
|       | reserved |    |    |    |    |    |    |    |    |    |    |    |     |     |     |     |
| Type  | WO       | WO | WO | WO | WO | WO | WO | WO | WO | WO | WO | WO | WO  | WO  | WO  | WO  |
| Reset | -        | -  | -  | -  | -  | -  | -  | -  | -  | -  | -  | -  | -   | -   | -   | -   |
|       | 15       | 14 | 13 | 12 | 11 | 10 | 9  | 8  | 7  | 6  | 5  | 4  | 3   | 2   | 1   | 0   |
|       | reserved |    |    |    |    |    |    |    |    |    |    |    | SS3 | SS2 | SS1 | SS0 |
| Type  | WO       | WO | WO | WO | WO | WO | WO | WO | WO | WO | WO | WO | WO  | WO  | WO  | WO  |
| Reset | -        | -  | -  | -  | -  | -  | -  | -  | -  | -  | -  | -  | -   | -   | -   | -   |

| Bit/Field | Name     | Type | Reset | Description   |
|-----------|----------|------|-------|---|
| 31:4      | reserved | WO   | -     | Only a write by software is valid; a read of the register returns no meaningful data.   |
| 3         | SS3      | WO   | -     | Only a write by software is valid; a read of the register returns no meaningful data. When set by software, sampling is triggered on Sample Sequencer 3, assuming the Sequencer is enabled in the <b>ADCACTSS</b> register. |
| 2         | SS2      | WO   | -     | Only a write by software is valid; a read of the register returns no meaningful data. When set by software, sampling is triggered on Sample Sequencer 2, assuming the Sequencer is enabled in the <b>ADCACTSS</b> register. |
| 1         | SS1      | WO   | -     | Only a write by software is valid; a read of the register returns no meaningful data. When set by software, sampling is triggered on Sample Sequencer 1, assuming the Sequencer is enabled in the <b>ADCACTSS</b> register. |
| 0         | SS0      | WO   | -     | Only a write by software is valid; a read of the register returns no meaningful data. When set by software, sampling is triggered on Sample Sequencer 0, assuming the Sequencer is enabled in the <b>ADCACTSS</b> register. |

**Register 10: ADC Sample Averaging Control (ADCSAC), offset 0x030**

This register controls the amount of hardware averaging applied to conversion results. The final conversion result stored in the FIFO is averaged from  $2^{AVG}$  consecutive ADC samples at the specified ADC speed. If AVG is 0, the sample is passed directly through without any averaging. If AVG is 6, 64 consecutive ADC samples are averaged to generate one result in the sequencer FIFO. An AVG = 7 provides unpredictable results.

ADC Sample Averaging Control (ADCSAC)

Offset 0x030

|       |          |    |    |    |    |    |    |    |    |    |    |    |    |     |     |     |
|-------|----------|----|----|----|----|----|----|----|----|----|----|----|----|-----|-----|-----|
|       | 31       | 30 | 29 | 28 | 27 | 26 | 25 | 24 | 23 | 22 | 21 | 20 | 19 | 18  | 17  | 16  |
|       | reserved |    |    |    |    |    |    |    |    |    |    |    |    |     |     |     |
| Type  | RO       | RO | RO | RO | RO | RO | RO | RO | RO | RO | RO | RO | RO | RO  | RO  | RO  |
| Reset | 0        | 0  | 0  | 0  | 0  | 0  | 0  | 0  | 0  | 0  | 0  | 0  | 0  | 0   | 0   | 0   |
|       | 15       | 14 | 13 | 12 | 11 | 10 | 9  | 8  | 7  | 6  | 5  | 4  | 3  | 2   | 1   | 0   |
|       | reserved |    |    |    |    |    |    |    |    |    |    |    |    | AVG |     |     |
| Type  | RO       | RO | RO | RO | RO | RO | RO | RO | RO | RO | RO | RO | RO | R/W | R/W | R/W |
| Reset | 0        | 0  | 0  | 0  | 0  | 0  | 0  | 0  | 0  | 0  | 0  | 0  | 0  | 0   | 0   | 0   |

| Bit/Field | Name     | Type | Reset | Description   |
|-----------|----------|------|-------|---|
| 31:3      | reserved | RO   | 0     | Reserved bits return an indeterminate value, and should never be changed.   |
| 2:0       | AVG      | R/W  | 0     | Specifies the amount of hardware averaging that will be applied to ADC samples. The <code>AVG</code> field can be any value between 0 and 6. Entering a value of 7 creates unpredictable results. |

**Register 11: ADC Sample Sequence Input Multiplexer Select 0 (ADCSSMUX0), offset 0x040**

This register defines the analog input configuration for each sample in a sequence executed with Sample Sequencer 0.

This register is 32-bits wide and contains information for eight possible samples.

## ADC Sample Sequence Input Multiplexer Select 0 (ADCSSMUX0)

Offset 0x040

|       |          |      |     |     |          |          |      |     |          |          |      |     |          |          |      |     |  |
|-------|----------|------|-----|-----|----------|----------|------|-----|----------|----------|------|-----|----------|----------|------|-----|--|
|       | 31       | 30   | 29  | 28  | 27       | 26       | 25   | 24  | 23       | 22       | 21   | 20  | 19       | 18       | 17   | 16  |  |
|       | reserved | MUX7 |     |     |          | reserved | MUX6 |     |          | reserved | MUX5 |     |          | reserved | MUX4 |     |  |
| Type  | RO       | R/W  | R/W | R/W | RO       | R/W      | R/W  | R/W | RO       | R/W      | R/W  | R/W | RO       | R/W      | R/W  | R/W |  |
| Reset | 0        | 0    | 0   | 0   | 0        | 0        | 0    | 0   | 0        | 0        | 0    | 0   | 0        | 0        | 0    | 0   |  |
|       | 15       | 14   | 13  | 12  | 11       | 10       | 9    | 8   | 7        | 6        | 5    | 4   | 3        | 2        | 1    | 0   |  |
|       | reserved | MUX3 |     |     | reserved | MUX2     |      |     | reserved | MUX1     |      |     | reserved | MUX0     |      |     |  |
| Type  | RO       | R/W  | R/W | R/W | RO       | R/W      | R/W  | R/W | RO       | R/W      | R/W  | R/W | RO       | R/W      | R/W  | R/W |  |
| Reset | 0        | 0    | 0   | 0   | 0        | 0        | 0    | 0   | 0        | 0        | 0    | 0   | 0        | 0        | 0    | 0   |  |

| Bit/Field | Name     | Type | Reset | Description   |
|-----------|----------|------|-------|---|
| 31        | reserved | RO   | 0     | Reserved bits return an indeterminate value, and should never be changed.   |
| 30:28     | MUX7     | R/W  | 0     | The MUX7 field is used during the eighth sample of a sequence executed with Sample Sequencer 0. It specifies which of the analog inputs is sampled for the analog-to-digital conversion. The value set here indicates the corresponding pin, for example, a value of 1 indicates the input is ADC1. |
| 27        | reserved | RO   | 0     | Reserved bits return an indeterminate value, and should never be changed.   |
| 26:24     | MUX6     | R/W  | 0     | The MUX6 field is used during the seventh sample of a sequence executed with Sample Sequencer 0 and specifies which of the analog inputs is sampled for the analog-to-digital conversion.   |
| 23        | reserved | RO   | 0     | Reserved bits return an indeterminate value, and should never be changed.   |
| 22:20     | MUX5     | R/W  | 0     | The MUX5 field is used during the sixth sample of a sequence executed with Sample Sequencer 0 and specifies which of the analog inputs is sampled for the analog-to-digital conversion.   |
| 19        | reserved | RO   | 0     | Reserved bits return an indeterminate value, and should never be changed.   |
| 18:16     | MUX4     | R/W  | 0     | The MUX4 field is used during the fifth sample of a sequence executed with Sample Sequencer 0 and specifies which of the analog inputs is sampled for the analog-to-digital conversion.   |
| 15        | reserved | RO   | 0     | Reserved bits return an indeterminate value, and should never be changed.   |
| 14:12     | MUX3     | R/W  | 0     | The MUX3 field is used during the fourth sample of a sequence executed with Sample Sequencer 0 and specifies which of the analog inputs is sampled for the analog-to-digital conversion.  |

| Bit/Field | Name     | Type | Reset | Description  |
|-----------|----------|------|-------|--|
| 11        | reserved | RO   | 0     | Reserved bits return an indeterminate value, and should never be changed.  |
| 10:8      | MUX2     | R/W  | 0     | The MUX2 field is used during the third sample of a sequence executed with Sample Sequencer 0 and specifies which of the analog inputs is sampled for the analog-to-digital conversion.  |
| 7         | reserved | RO   | 0     | Reserved bits return an indeterminate value, and should never be changed.  |
| 6:4       | MUX1     | R/W  | 0     | The MUX1 field is used during the second sample of a sequence executed with Sample Sequencer 0 and specifies which of the analog inputs is sampled for the analog-to-digital conversion. |
| 3         | reserved | RO   | 0     | Reserved bits return an indeterminate value, and should never be changed.  |
| 2:0       | MUX0     | R/W  | 0     | The MUX0 field is used during the first sample of a sequence executed with Sample Sequencer 0 and specifies which of the analog inputs is sampled for the analog-to-digital conversion.  |

**Register 12: ADC Sample Sequence Control 0 (ADCSSCTL0), offset 0x044**

This register contains the configuration information for each sample for a sequence executed with Sample Sequencer 0. When configuring a sample sequence, the `END` bit must be set at some point, whether it be after the first sample, last sample, or any sample in between.

This register is 32-bits wide and contains information for eight possible samples.

## ADC Sample Sequence Control 0 (ADCSSCTL0)

Offset 0x044

|       |     |     |      |     |     |     |      |     |     |     |      |     |     |     |      |     |
|-------|-----|-----|------|-----|-----|-----|------|-----|-----|-----|------|-----|-----|-----|------|-----|
|       | 31  | 30  | 29   | 28  | 27  | 26  | 25   | 24  | 23  | 22  | 21   | 20  | 19  | 18  | 17   | 16  |
|       | TS7 | IE7 | END7 | D7  | TS6 | IE6 | END6 | D6  | TS5 | IE5 | END5 | D5  | TS4 | IE4 | END4 | D4  |
| Type  | R/W | R/W | R/W  | R/W | R/W | R/W | R/W  | R/W | R/W | R/W | R/W  | R/W | R/W | R/W | R/W  | R/W |
| Reset | 0   | 0   | 0    | 0   | 0   | 0   | 0    | 0   | 0   | 0   | 0    | 0   | 0   | 0   | 0    | 0   |
|       | 15  | 14  | 13   | 12  | 11  | 10  | 9    | 8   | 7   | 6   | 5    | 4   | 3   | 2   | 1    | 0   |
|       | TS3 | IE3 | END3 | D3  | TS2 | IE2 | END2 | D2  | TS1 | IE1 | END1 | D1  | TS0 | IE0 | END0 | D0  |
| Type  | R/W | R/W | R/W  | R/W | R/W | R/W | R/W  | R/W | R/W | R/W | R/W  | R/W | R/W | R/W | R/W  | R/W |
| Reset | 0   | 0   | 0    | 0   | 0   | 0   | 0    | 0   | 0   | 0   | 0    | 0   | 0   | 0   | 0    | 0   |

| Bit/Field | Name | Type | Reset | Description   |
|-----------|------|------|-------|---|
| 31        | TS7  | R/W  | 0     | The <code>TS7</code> bit is used during the eighth sample of the sample sequence and specifies the input source of the sample. If set, the temperature sensor is read. Otherwise, the input pin specified by the <code>ADCAMUX</code> register is read.   |
| 30        | IE7  | R/W  | 0     | The <code>IE7</code> bit is used during the eighth sample of the sample sequence and specifies whether the raw interrupt signal ( <code>INR0</code> bit) is asserted at the end of the sample's conversion. If the <code>MASK0</code> bit in the <code>ADCIM</code> register is set, the interrupt is promoted to a controller-level interrupt. When this bit is set, the raw interrupt is asserted, otherwise it is not. It is legal to have multiple samples within a sequence generate interrupts.   |
| 29        | END7 | R/W  | 0     | The <code>END7</code> bit indicates that this is the last sample of the sequence. It is possible to end the sequence on any sample position. Samples defined after the sample containing a set <code>END</code> are not requested for conversion even though the fields may be non-zero. It is required that software write the <code>END</code> bit somewhere within the sequence. (Sample Sequencer 3, which only has a single sample in the sequence, is hardwired to have the <code>END0</code> bit set.)<br><br>Setting this bit indicates that this sample is the last in the sequence. |
| 28        | D7   | R/W  | 0     | The <code>D7</code> bit indicates that the analog input is to be differentially sampled. The corresponding <code>ADCSSMUXx</code> nibble must be set to the pair number "i", where the paired inputs are "2i and 2i+1". The temperature sensor does not have a differential option. When set, the analog inputs are differentially sampled.   |
| 27        | TS6  | R/W  | 0     | Same definition as <code>TS7</code> but used during the seventh sample.   |
| 26        | IE6  | R/W  | 0     | Same definition as <code>IE7</code> but used during the seventh sample.   |
| 25        | END6 | R/W  | 0     | Same definition as <code>END7</code> but used during the seventh sample.  |

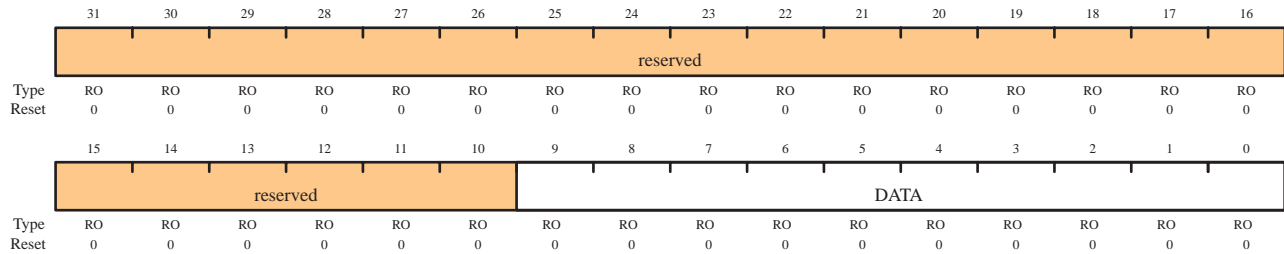
| Bit/Field | Name | Type | Reset | Description   |
|-----------|------|------|-------|---|
| 24        | D6   | R/W  | 0     | Same definition as D7 but used during the seventh sample.   |
| 23        | TS5  | R/W  | 0     | Same definition as TS7 but used during the sixth sample.  |
| 22        | IE5  | R/W  | 0     | Same definition as IE7 but used during the sixth sample.  |
| 21        | END5 | R/W  | 0     | Same definition as END7 but used during the sixth sample.   |
| 20        | D5   | R/W  | 0     | Same definition as D7 but used during the sixth sample.   |
| 19        | TS4  | R/W  | 0     | Same definition as TS7 but used during the fifth sample.  |
| 18        | IE4  | R/W  | 0     | Same definition as IE7 but used during the fifth sample.  |
| 17        | END4 | R/W  | 0     | Same definition as END7 but used during the fifth sample.   |
| 16        | D4   | R/W  | 0     | Same definition as D7 but used during the fifth sample.   |
| 15        | TS3  | R/W  | 0     | Same definition as TS7 but used during the fourth sample.   |
| 14        | IE3  | R/W  | 0     | Same definition as IE7 but used during the fourth sample.   |
| 13        | END3 | R/W  | 0     | Same definition as END7 but used during the fourth sample.  |
| 12        | D3   | R/W  | 0     | Same definition as D7 but used during the fourth sample.  |
| 11        | TS2  | R/W  | 0     | Same definition as TS7 but used during the third sample.  |
| 10        | IE2  | R/W  | 0     | Same definition as IE7 but used during the third sample.  |
| 9         | END2 | R/W  | 0     | Same definition as END7 but used during the third sample.   |
| 8         | D2   | R/W  | 0     | Same definition as D7 but used during the third sample.   |
| 7         | TS1  | R/W  | 0     | Same definition as TS7 but used during the second sample.   |
| 6         | IE1  | R/W  | 0     | Same definition as IE7 but used during the second sample.   |
| 5         | END1 | R/W  | 0     | Same definition as END7 but used during the second sample.  |
| 4         | D1   | R/W  | 0     | Same definition as D7 but used during the second sample.  |
| 3         | TS0  | R/W  | 0     | Same definition as TS7 but used during the first sample.  |
| 2         | IE0  | R/W  | 0     | Same definition as IE7 but used during the first sample.  |
| 1         | END0 | R/W  | 0     | Same definition as END7 but used during the first sample.<br>Since this sequencer has only one entry, this bit must be set. |
| 0         | D0   | R/W  | 0     | Same definition as D7 but used during the first sample.   |

**Register 13: ADC Sample Sequence Result FIFO 0 (ADCSSFIFO0), offset 0x048**

This register contains the conversion results for samples collected with Sample Sequencer 0. Reads of this register return conversion result data in the order sample 0, sample 1, and so on, until the FIFO is empty. If the FIFO is not properly handled by software, overflow and underflow conditions are registered in the **ADCSTAT** and **ADCUSTAT** registers.

ADC Sample Sequence Result FIFO 0 (ADCSSFIFO0)

Offset 0x048



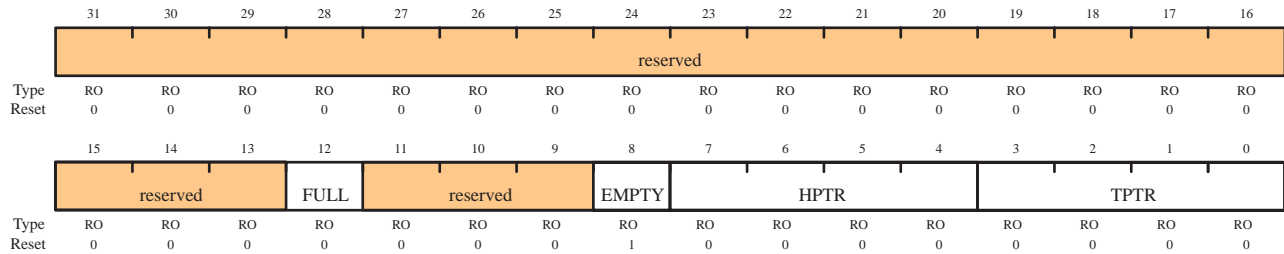
| Bit/Field | Name     | Type | Reset | Description   |
|-----------|----------|------|-------|---|
| 31:10     | reserved | RO   | 0     | Reserved bits return an indeterminate value, and should never be changed. |
| 9:0       | DATA     | RO   | 0     | Conversion result data.   |

**Register 14: ADC Sample Sequence FIFO 0 Status (ADCSSFSTAT0), offset 0x04C**

This register provides a window into the Sample Sequencer FIFO 0, providing full/empty status information as well as the positions of the head and tail pointers. The reset value of 0x100 indicates an empty FIFO.

ADC Sample Sequence FIFO 0 Status (ADCSSFSTAT0)

Offset 0x04C



| Bit/Field | Name     | Type | Reset | Description   |
|-----------|----------|------|-------|---|
| 31:13     | reserved | RO   | 0     | Reserved bits return an indeterminate value, and should never be changed.                                 |
| 12        | FULL     | RO   | 0     | When set, indicates that the FIFO is currently full.  |
| 11:9      | reserved | RO   | 0     | Reserved bits return an indeterminate value, and should never be changed.                                 |
| 8         | EMPTY    | RO   | 1     | When set, indicates that the FIFO is currently empty.   |
| 7:4       | HPTR     | RO   | 0     | This field contains the current "head" pointer index for the FIFO, that is, the next entry to be written. |
| 3:0       | TPTR     | RO   | 0     | This field contains the current "tail" pointer index for the FIFO, that is, the next entry to be read.    |



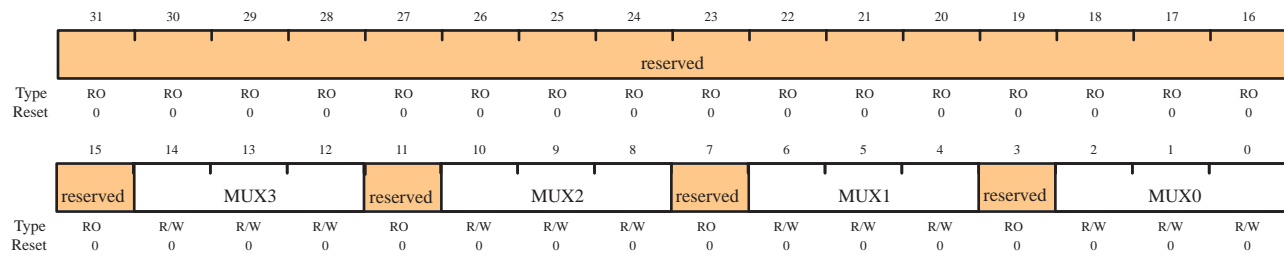
**Register 15: ADC Sample Sequence Input Multiplexer Select 1 (ADCSSMUX1), offset 0x060**

This register defines the analog input configuration for each sample in a sequence executed with Sample Sequencer 1.

This register is 16-bits wide and contains information for four possible samples. This register's bit fields are as shown in the diagram below. Bit field definitions are the same as those in the **ADCSSMUX0** register (see page 211) but are for Sample Sequencer 1.

## ADC Sample Sequence Input Multiplexer Select 1 (ADCSSMUX1)

Offset 0x060



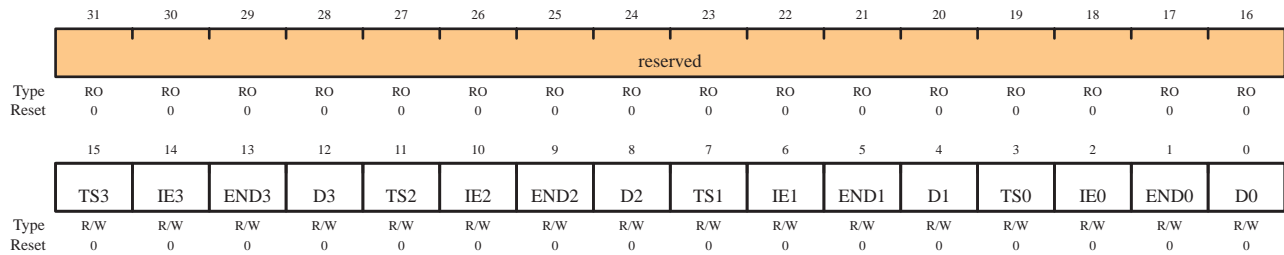
**Register 16: ADC Sample Sequence Control 1 (ADCSSCTL1), offset 0x064**

This register contains the configuration information for each sample for a sequence executed with Sample Sequencer 1. When configuring a sample sequence, the `END` bit must be set at some point, whether it be after the first sample, last sample, or any sample in between.

This register is 16-bits wide and contains information for four possible samples. This register's bit fields are as shown in the diagram below. Bit field definitions are the same as those in the **ADCSSCTL0** register (see page 213) but are for Sample Sequencer 1.

ADC Sample Sequence Control 1 (ADCSSCTL1)

Offset 0x064



**Register 17: ADC Sample Sequence Result FIFO 1 (ADCSSFIFO1), offset 0x068**

This register contains the conversion results for samples collected with Sample Sequencer 1. Reads of this register return conversion result data in the order sample 0, sample 1, and so on, until the FIFO is empty. If the FIFO is not properly handled by software, overflow and underflow conditions are registered in the **ADCSTAT** and **ADCUSTAT** registers.

Bit fields and definitions are the same as **ADCSSFIFO0** (see page 215) but are for FIFO 1.

**Register 18: ADC Sample Sequence FIFO 1 Status (ADCSSFSTAT1), offset 0x06C**

This register provides a window into the Sample Sequencer FIFO 1, providing full/empty status information as well as the positions of the head and tail pointers. The reset value of 0x100 indicates an empty FIFO.

This register has the same bit fields and definitions as **ADCSSFSTAT0** (see page 216) but is for FIFO 1.

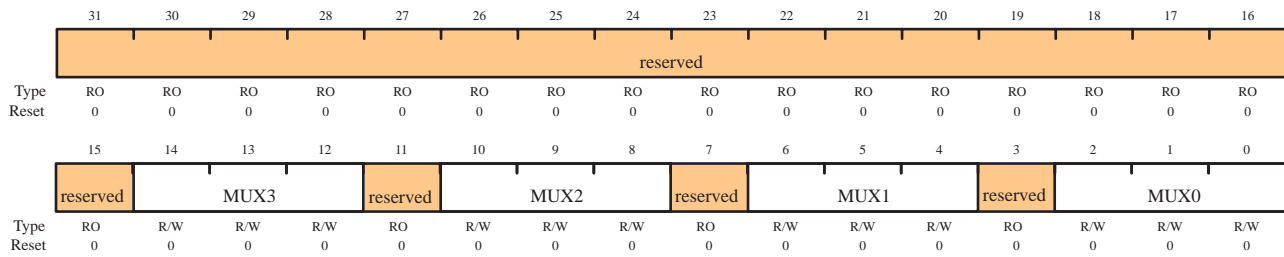
**Register 19: ADC Sample Sequence Input Multiplexer Select 2 (ADCSSMUX2), offset 0x080**

This register defines the analog input configuration for each sample in a sequence executed with Sample Sequencer 2.

This register is 16-bits wide and contains information for four possible samples. This register's bit fields are as shown in the diagram below. Bit field definitions are the same as those in the **ADCSSMUX0** register (see page 211) but are for Sample Sequencer 2.

ADC Sample Sequence Input Multiplexer Select 2 (ADCSSMUX2)

Offset 0x080



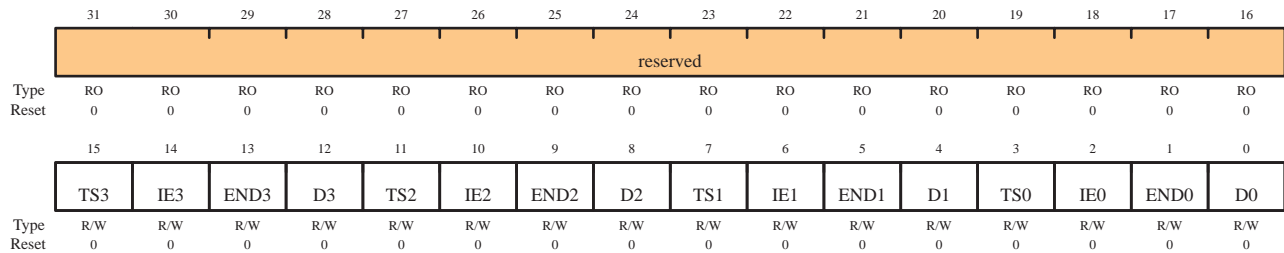
**Register 20: ADC Sample Sequence Control 2 (ADCSSCTL2), offset 0x084**

This register contains the configuration information for each sample for a sequence executed with Sample Sequencer 2. When configuring a sample sequence, the `END` bit must be set at some point, whether it be after the first sample, last sample, or any sample in between.

This register is 16-bits wide and contains information for four possible samples. This register's bit fields are as shown in the diagram below. Bit field definitions are the same as those in the **ADCSSCTL0** register (see page 213) but are for Sample Sequencer 2.

ADC Sample Sequence Control 2 (ADCSSCTL2)

Offset 0x084



**Register 21: ADC Sample Sequence Result FIFO 2 (ADCSSFIFO2), offset 0x088**

This register contains the conversion results for samples collected with Sample Sequencer 2. Reads of this register return conversion result data in the order sample 0, sample 1, and so on, until the FIFO is empty. If the FIFO is not properly handled by software, overflow and underflow conditions are registered in the **ADCSTAT** and **ADCUSTAT** registers.

Bit fields and definitions are the same as **ADCSSFIFO0** (see page 215) but are for FIFO 2.

**Register 22: ADC Sample Sequence FIFO 2 Status (ADCSSFSTAT2), offset 0x08C**

This register provides a window into the Sample Sequencer FIFO 2, providing full/empty status information as well as the positions of the head and tail pointers. The reset value of 0x100 indicates an empty FIFO.

This register has the same bit fields and definitions as **ADCSSFSTAT0** (see page 216) but is for FIFO 2.

**Register 23: ADC Sample Sequence Input Multiplexer Select 3 (ADCSSMUX3), offset 0x0A0**

This register defines the analog input configuration for each sample in a sequence executed with Sample Sequencer 3.

This register is 4-bits wide and contains information for one possible sample. This register's bit fields are as shown in the diagram below. Bit field definitions are the same as those in the **ADCSSMUX0** register ( see page 211) but are for Sample Sequencer 3.

ADC Sample Sequence Input Multiplexer Select 3 (ADCSSMUX3)

Offset 0x0A0

|       | 31       | 30 | 29 | 28 | 27 | 26 | 25 | 24 | 23 | 22 | 21 | 20 | 19 | 18   | 17  | 16  |
|-------|----------|----|----|----|----|----|----|----|----|----|----|----|----|------|-----|-----|
|       | reserved |    |    |    |    |    |    |    |    |    |    |    |    |      |     |     |
| Type  | RO       | RO | RO | RO | RO | RO | RO | RO | RO | RO | RO | RO | RO | RO   | RO  | RO  |
| Reset | 0        | 0  | 0  | 0  | 0  | 0  | 0  | 0  | 0  | 0  | 0  | 0  | 0  | 0    | 0   | 0   |
|       | 15       | 14 | 13 | 12 | 11 | 10 | 9  | 8  | 7  | 6  | 5  | 4  | 3  | 2    | 1   | 0   |
|       | reserved |    |    |    |    |    |    |    |    |    |    |    |    | MUX0 |     |     |
| Type  | RO       | RO | RO | RO | RO | RO | RO | RO | RO | RO | RO | RO | RO | R/W  | R/W | R/W |
| Reset | 0        | 0  | 0  | 0  | 0  | 0  | 0  | 0  | 0  | 0  | 0  | 0  | 0  | 0    | 0   | 0   |

**Register 24: ADC Sample Sequence Control 3 (ADCSSCTL3), offset 0x064**

This register contains the configuration information for each sample for a sequence executed with Sample Sequencer 3. The `END` bit is always set since there is only one sample in this sequencer.

This register is 4-bits wide and contains information for one possible sample. This register's bit fields are as shown in the diagram below. Bit field definitions are the same as those in the **ADCSSCTL0** register (see page 213) but are for Sample Sequencer 3.

ADC Sample Sequence Control 3 (ADCSSCTL3)

Offset 0x0A4

|       |          |    |    |    |    |    |    |    |    |    |    |    |     |     |      |     |     |
|-------|----------|----|----|----|----|----|----|----|----|----|----|----|-----|-----|------|-----|-----|
|       | 31       | 30 | 29 | 28 | 27 | 26 | 25 | 24 | 23 | 22 | 21 | 20 | 19  | 18  | 17   | 16  |     |
|       | reserved |    |    |    |    |    |    |    |    |    |    |    |     |     |      |     |     |
| Type  | RO       | RO | RO | RO | RO | RO | RO | RO | RO | RO | RO | RO | RO  | RO  | RO   | RO  |     |
| Reset | 0        | 0  | 0  | 0  | 0  | 0  | 0  | 0  | 0  | 0  | 0  | 0  | 0   | 0   | 0    | 0   |     |
|       | 15       | 14 | 13 | 12 | 11 | 10 | 9  | 8  | 7  | 6  | 5  | 4  | 3   | 2   | 1    | 0   |     |
|       | reserved |    |    |    |    |    |    |    |    |    |    |    | TS0 | IE0 | END0 | D0  |     |
| Type  | RO       | RO | RO | RO | RO | RO | RO | RO | RO | RO | RO | RO | RO  | R/W | R/W  | R/W | R/W |
| Reset | 0        | 0  | 0  | 0  | 0  | 0  | 0  | 0  | 0  | 0  | 0  | 0  | 0   | 0   | 0    | 1   | 0   |

**Register 25: ADC Sample Sequence Result FIFO 3 (ADCSSFIFO3), offset 0x0A8**

This register contains the conversion results for samples collected with Sample Sequencer 3. Reads of this register return the conversion result data. If the FIFO is not properly handled by software, overflow and underflow conditions are registered in the **ADCOSTAT** and **ADCUSTAT** registers.

Bit fields and definitions are the same as **ADCSSFIFO0** (see page 215) but are for FIFO 3.

**Register 26: ADC Sample Sequence FIFO 3 Status (ADCSSFSTAT3), offset 0x0AC**

This register provides a window into the Sample Sequencer FIFO 3, providing full/empty status information as well as the positions of the head and tail pointers. The reset value of 0x100 indicates an empty FIFO.

This register has the same bit fields and definitions as **ADCSSFSTAT0** (see page 216) but is for FIFO 3.

**Register 27: ADC Test Mode Loopback (ADCTMLB), offset 0x100**

This register provides loopback operation within the digital logic of the ADC, which can be useful in debugging software without having to provide actual analog stimulus. This test mode is entered by writing a value of 0x00000001 to this register. When data is read from the FIFO in loopback mode, the read-only portion of this register is returned.

## ADC Test Mode Loopback (ADCTMLB): Read

Offset 0x100

|       |          |    |    |    |    |    |     |    |      |      |    |     |    |    |    |    |
|-------|----------|----|----|----|----|----|-----|----|------|------|----|-----|----|----|----|----|
|       | 31       | 30 | 29 | 28 | 27 | 26 | 25  | 24 | 23   | 22   | 21 | 20  | 19 | 18 | 17 | 16 |
|       | reserved |    |    |    |    |    |     |    |      |      |    |     |    |    |    |    |
| Type  | RO       | RO | RO | RO | RO | RO | RO  | RO | RO   | RO   | RO | RO  | RO | RO | RO | RO |
| Reset | 0        | 0  | 0  | 0  | 0  | 0  | 0   | 0  | 0    | 0    | 0  | 0   | 0  | 0  | 0  | 0  |
|       | 15       | 14 | 13 | 12 | 11 | 10 | 9   | 8  | 7    | 6    | 5  | 4   | 3  | 2  | 1  | 0  |
|       | reserved |    |    |    |    |    | CNT |    | CONT | DIFF | TS | MUX |    |    |    |    |
| Type  | RO       | RO | RO | RO | RO | RO | RO  | RO | RO   | RO   | RO | RO  | RO | RO | RO | RO |
| Reset | 0        | 0  | 0  | 0  | 0  | 0  | 0   | 0  | 0    | 0    | 0  | 0   | 0  | 0  | 0  | 0  |

## ADC Test Mode Loopback (ADCTMLB): Write

Offset 0x100

|       |          |    |    |    |    |    |    |    |    |    |    |    |    |    |    |    |
|-------|----------|----|----|----|----|----|----|----|----|----|----|----|----|----|----|----|
|       | 31       | 30 | 29 | 28 | 27 | 26 | 25 | 24 | 23 | 22 | 21 | 20 | 19 | 18 | 17 | 16 |
|       | reserved |    |    |    |    |    |    |    |    |    |    |    |    |    |    |    |
| Type  | RO       | RO | RO | RO | RO | RO | RO | RO | RO | RO | RO | RO | RO | RO | RO | RO |
| Reset | 0        | 0  | 0  | 0  | 0  | 0  | 0  | 0  | 0  | 0  | 0  | 0  | 0  | 0  | 0  | 0  |
|       | 15       | 14 | 13 | 12 | 11 | 10 | 9  | 8  | 7  | 6  | 5  | 4  | 3  | 2  | 1  | 0  |
|       | reserved |    |    |    |    |    |    |    |    |    |    |    |    |    |    | LB |
| Type  | RO       | RO | RO | RO | RO | RO | RO | RO | RO | RO | RO | RO | RO | RO | RO | WO |
| Reset | 0        | 0  | 0  | 0  | 0  | 0  | 0  | 0  | 0  | 0  | 0  | 0  | 0  | 0  | 0  | 0  |

| Bit/Field | Name | Type | Reset | Description |
|-----------|------|------|-------|-------------|
|-----------|------|------|-------|-------------|

**Read-Only Register**

|       |          |    |   |   |
|-------|----------|----|---|---|
| 31:10 | reserved | RO | 0 | Reserved bits return an indeterminate value, and should never be changed.   |
| 9:6   | CNT      | RO | 0 | Continuous sample counter that is initialized to 0 and counts each sample as it processed. This helps provide a unique value for the data received.   |
| 5     | CONT     | RO | 0 | When set, indicates that this is a continuation sample. For example if two sequencers were to run back-to-back, this indicates that the controller kept continuously sampling at full rate. |
| 4     | DIFF     | RO | 0 | When set, indicates that this was to be a differential sample.  |
| 3     | TS       | RO | 0 | When set, indicates that this was to be a temperature sensor sample.  |
| 2:0   | MUX      | RO | 0 | Indicate which analog input was to be sampled.  |

| Bit/Field                  | Name     | Type | Reset | Description  |
|----------------------------|----------|------|-------|--|
| <b>Write-Only Register</b> |          |      |       |  |
| 31:1                       | reserved | RO   | 0     | Reserved bits return an indeterminate value, and should never be changed.  |
| 0                          | LB       | WO   | 0     | When set, forces a loopback within the digital block to provide information on input and unique numbering.<br>The 10-bit loopback data is defined as shown in the read for bits 9:0 below. |



## 12 Universal Asynchronous Receivers/Transmitters (UARTs)

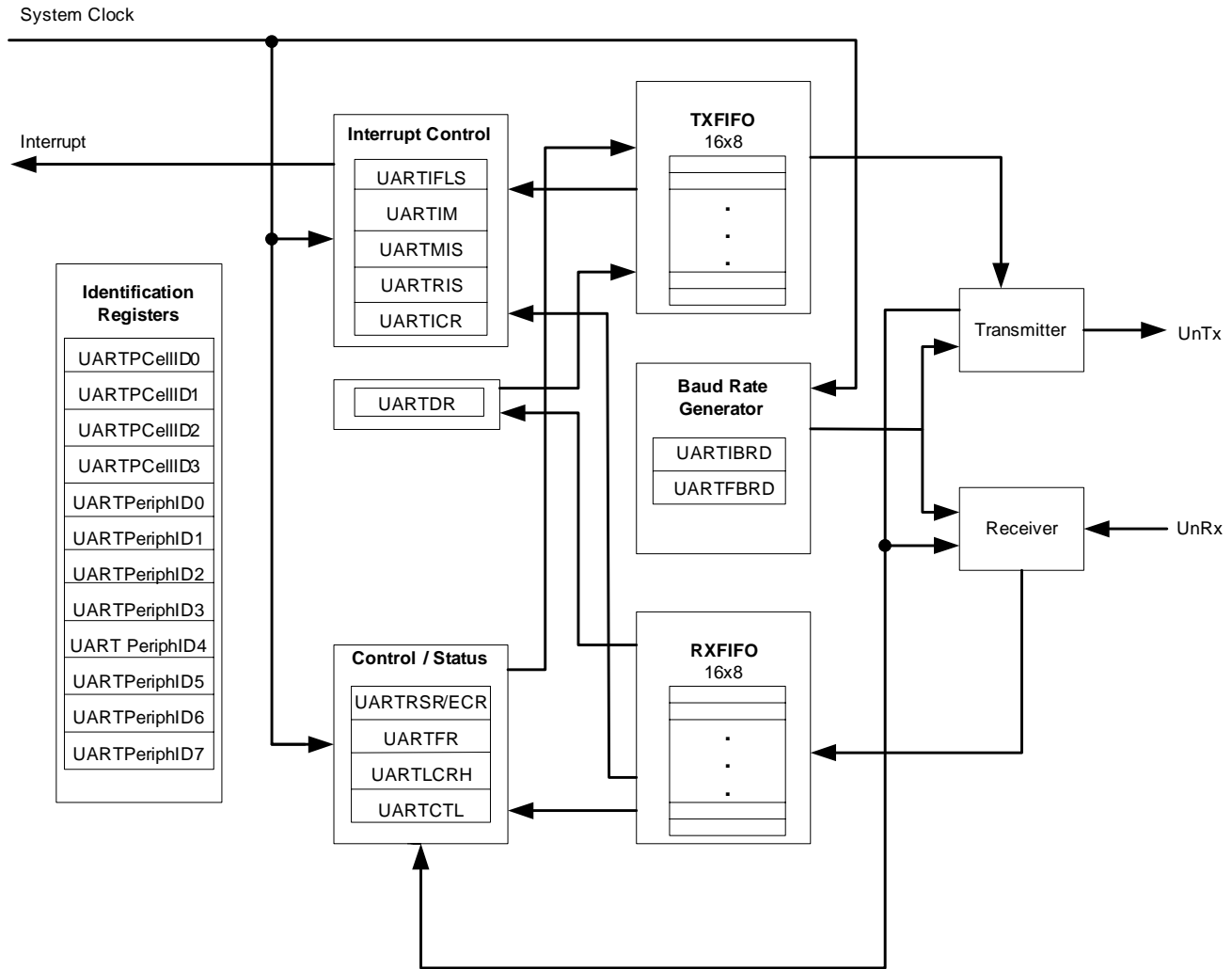
The Universal Asynchronous Receivers/Transmitters (UARTs) provide fully programmable, 16C550-type serial interface characteristics. The LM3S628 controller is equipped with two UART modules.

Each UART has the following features:

- Separate transmit and receive FIFOs
- Programmable FIFO length, including 1-byte deep operation providing conventional double-buffered interface
- FIFO trigger levels of 1/8, 1/4, 1/2, 3/4, and 7/8
- Programmable baud-rate generator allowing rates up to 460.8 Kbps
- Standard asynchronous communication bits for start, stop and parity
- False start bit detection
- Line-break generation and detection
- Fully programmable serial interface characteristics:
  - 5, 6, 7, or 8 data bits
  - Even, odd, stick, or no-parity bit generation/detection
  - 1 or 2 stop bit generation

## 12.1 Block Diagram

Figure 12-1. UART Module Block Diagram



## 12.2 Functional Description

The Stellaris UART performs the functions of parallel-to-serial and serial-to-parallel conversions. It is similar in functionality to a 16C550 UART, but is not register compatible.

The UART is configured for transmit and/or receive via the TXE and RXE bits of the **UART Control (UARTCTL)** register (see page 242). Transmit and receive are both enabled out of reset. Before any control registers are programmed, the UART must be disabled by clearing the UARTEEN bit in **UARTCTL**. If the UART is disabled during a TX or RX operation, the current transaction is completed prior to the UART stopping.

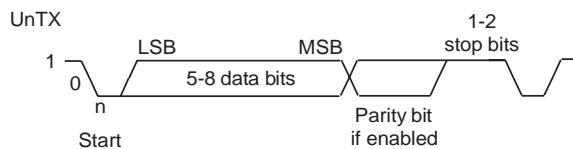
### 12.2.1 Transmit/Receive Logic

The transmit logic performs parallel-to-serial conversion on the data read from the transmit FIFO. The control logic outputs the serial bit stream beginning with a start bit, and followed by the data

bits (LSB first), parity bit, and the stop bits according to the programmed configuration in the control registers. See Figure 12-2 for details.

The receive logic performs serial-to-parallel conversion on the received bit stream after a valid start pulse has been detected. Overrun, parity, frame error checking, and line-break detection are also performed, and their status accompanies the data that is written to the receive FIFO.

**Figure 12-2. UART Character Frame**



## 12.2.2 Baud-Rate Generation

The baud-rate divisor is a 22-bit number consisting of a 16-bit integer and a 6-bit fractional part. The number formed by these two values is used by the baud-rate generator to determine the bit period. Having a fractional baud-rate divider allows the UART to generate all the standard baud rates.

The 16-bit integer is loaded through the **UART Integer Baud-Rate Divisor (UARTIBRD)** register (see page 238) and the 6-bit fractional part is loaded with the **UART Fractional Baud-Rate Divisor (UARTFBRD)** register (see page 239). The baud-rate divisor (BRD) has the following relationship to the system clock (where *BRDI* is the integer part of the BRD and *BRDF* is the fractional part, separated by a decimal place.):

$$\text{BRD} = \text{BRDI} + \text{BRDF} = \text{SysClk} / (16 * \text{Baud Rate})$$

The 6-bit fractional number (that is to be loaded into the *DIVFRAC* bit field in the **UARTFBRD** register) can be calculated by taking the fractional part of the baud-rate divisor, multiplying it by 64, and adding 0.5 to account for rounding errors:

$$\text{UARTFBRD}[\text{DIVFRAC}] = \text{integer}(\text{BRDF} * 64 + 0.5)$$

The UART generates an internal baud-rate reference clock at 16x the baud-rate (referred to as *Baud16*). This reference clock is divided by 16 to generate the transmit clock, and is used for error detection during receive operations.

Along with the **UART Line Control, High Byte (UARTLCRH)** register (see page 240), the **UARTIBRD** and **UARTFBRD** registers form an internal 30-bit register. This internal register is only updated when a write operation to **UARTLCRH** is performed, so any changes to the baud-rate divisor must be followed by a write to the **UARTLCRH** register for the changes to take effect.

To update the baud-rate registers, there are four possible sequences:

- **UARTIBRD** write, **UARTFBRD** write, and **UARTLCRH** write
- **UARTFBRD** write, **UARTIBRD** write, and **UARTLCRH** write
- **UARTIBRD** write and **UARTLCRH** write
- **UARTFBRD** write and **UARTLCRH** write

### 12.2.3 Data Transmission

Data received or transmitted is stored in two 16-byte FIFOs, though the receive FIFO has an extra four bits per character for status information. For transmission, data is written into the transmit FIFO. If the UART is enabled, it causes a data frame to start transmitting with the parameters indicated in the **UARTLCRH** register. Data continues to be transmitted until there is no data left in the transmit FIFO. The **BUSY** bit in the **UART Flag (UARTFR)** register (see page 236) is asserted as soon as data is written to the transmit FIFO (that is, if the FIFO is non-empty) and remains asserted while data is being transmitted. The **BUSY** bit is negated only when the transmit FIFO is empty, and the last character has been transmitted from the shift register, including the stop bits. The UART can indicate that it is busy even though the UART may no longer be enabled.

When the receiver is idle (the U0Rx or U1Rx is continuously 1) and the data input goes Low (a start bit has been received), the receive counter begins running and data is sampled on the eighth cycle of **Baud16** (described in “Transmit/Receive Logic” on page 226).

The start bit is valid if U0Rx or U1Rx is still low on the eighth cycle of **Baud16**, otherwise a false start bit is detected and it is ignored. Start bit errors can be viewed in the **UART Receive Status (UARTRSR)** register (see page 234). If the start bit was valid, successive data bits are sampled on every 16th cycle of **Baud16** (that is, one bit period later) according to the programmed length of the data characters. The parity bit is then checked if parity mode was enabled. Data length and parity are defined in the **UARTLCRH** register.

Lastly, a valid stop bit is confirmed if U0Rx or U1Rx is High, otherwise a framing error has occurred. When a full word is received, the data is stored in the receive FIFO, with any error bits associated with that word.

### 12.2.4 FIFO Operation

The UART has two 16-entry FIFOs; one for transmit and one for receive. Both FIFOs are accessed via the **UART Data (UARTDR)** register (see page 232). Read operations of the **UARTDR** register return a 12-bit value consisting of 8 data bits and 4 error flags while write operations place 8-bit data in the transmit FIFO.

Out of reset, both FIFOs are disabled and act as 1-byte-deep holding registers. The FIFOs are enabled by setting the **FEN** bit in **UARTLCRH** (page 240).

FIFO status can be monitored via the **UART Flag (UARTFR)** register (see page 236) and the **UART Receive Status (UARTRSR)** register. Hardware monitors empty, full and overrun conditions. The **UARTFR** register contains empty and full flags (**TXFE**, **TXFF**, **RXFE** and **RXFF** bits) and the **UARTRSR** register shows overrun status via the **OE** bit.

The trigger points at which the FIFOs generate interrupts is controlled via the **UART Interrupt FIFO Level Select (UARTIFLS)** register (see page 243). Both FIFOs can be individually configured to trigger interrupts at different levels. Available configurations include 1/8, 1/4, 1/2, 3/4 and 7/8. For example, if the 1/4 option is selected for the receive FIFO, the UART generates a receive interrupt after 4 data bytes are received. Out of reset, both FIFOs are configured to trigger an interrupt at the 1/2 mark.

### 12.2.5 Interrupts

The UART can generate interrupts when the following conditions are observed:

- Overrun Error
- Break Error
- Parity Error
- Framing Error

- Receive Timeout
- Transmit (when condition defined in the TXIFLSEL bit in the **UARTIFLS** register is met)
- Receive (when condition defined in the RXIFLSEL bit in the **UARTIFLS** register is met)

All of the interrupt events are ORed together before being sent to the interrupt controller, so the UART can only generate a single interrupt request to the controller at any given time. Software can service multiple interrupt events in a single interrupt service routine by reading the **UART Masked Interrupt Status (UARTMIS)** register (see page 247).

The interrupt events that can trigger a controller-level interrupt are defined in the **UART Interrupt Mask (UARTIM)** register (see page 244) by setting the corresponding **IM** bit to 1. If interrupts are not used, the raw interrupt status is always visible via the **UART Raw Interrupt Status (UARTRIS)** register (see page 246).

Interrupts are always cleared (for both the **UARTMIS** and **UARTRIS** registers) by setting the corresponding bit in the **UART Interrupt Clear (UARTICR)** register (see page 248).

### 12.2.6 Loopback Operation

The UART can be placed into an internal loopback mode for diagnostic or debug work. This is accomplished by setting the **LBE** bit in the **UARTCTL** register (see page 242). In loopback mode, data transmitted on U0Tx is received on the U0Rx input, and data transmitted on U1Tx is received on the U1Rx input.

## 12.3 Initialization and Configuration

To use the UARTs, the peripheral clock must be enabled by setting the **UART0** or **UART1** bits in the **RCGC1** register.

This section discusses the steps that are required for using a UART module. For this example, the system clock is assumed to be 20 MHz and the desired UART configuration is:

- 115200 baud rate
- Data length of 8 bits
- One stop bit
- No parity
- FIFOs disabled
- No interrupts

The first thing to consider when programming the UART is the baud-rate divisor (BRD), since the **UARTIBRD** and **UARTFBRD** registers must be written before the **UARTLCRH** register. Using the equation described in “Baud-Rate Generation” on page 227, the BRD can be calculated:

$$\text{BRD} = 20,000,000 / (16 * 115,200) = 10.8507$$

which means that the **DIVINT** field of the **UARTIBRD** register (see page 238) should be set to 10. The value to be loaded into the **UARTFBRD** register (see page 239) is calculated by the equation:

$$\text{UARTFBRD}[\text{DIVFRAC}] = \text{integer}(0.8507 * 64 + 0.5) = 54$$

With the BRD values in hand, the UART configuration is written to the module in the following order:

1. Disable the UART by clearing the **UARTEN** bit in the **UARTCTL** register.
2. Write the integer portion of the BRD to the **UARTIBRD** register.

3. Write the fractional portion of the BRD to the **UARTFBRD** register.
4. Write the desired serial parameters to the **UARTLCRH** register (in this case, a value of 0x00000060).
5. Enable the UART by setting the **UARTEN** bit in the **UARTCTL** register.

## 12.4 Register Map

Table 12-1 lists the UART registers. The offset listed is a hexadecimal increment to the register's address, relative to that UART's base address:

- UART0: 0x4000C000
- UART1: 0x4000D000

**Note:** The UART must be disabled (see the **UARTEN** bit in the **UARTCTL** register on page 242) before any of the control registers are reprogrammed. When the UART is disabled during a TX or RX operation, the current transaction is completed prior to the UART stopping.

**Table 12-1. UART Register Map**

| Offset | Name               | Reset      | Type | Description                                  | See page |
|--------|--------------------|------------|------|--|----------|
| 0x000  | UARTDR             | 0x00000000 | R/W  | Data   | 232      |
| 0x004  | UARTRSR<br>UARTECR | 0x00000000 | R/W  | Receive Status (read)<br>Error Clear (write) | 234      |
| 0x018  | UARTFR             | 0x00000090 | RO   | Flag Register (read only)                    | 236      |
| 0x024  | UARTIBRD           | 0x00000000 | R/W  | Integer Baud-Rate Divisor                    | 238      |
| 0x028  | UARTFBRD           | 0x00000000 | R/W  | Fractional Baud-Rate Divisor                 | 239      |
| 0x02C  | UARTLCRH           | 0x00000000 | R/W  | Line Control Register, High byte             | 240      |
| 0x030  | UARTCTL            | 0x00000300 | R/W  | Control Register                             | 242      |
| 0x034  | UARTIFLS           | 0x00000012 | R/W  | Interrupt FIFO Level Select                  | 243      |
| 0x038  | UARTIM             | 0x00000000 | R/W  | Interrupt Mask                               | 244      |
| 0x03C  | UARTRIS            | 0x0000000F | RO   | Raw Interrupt Status                         | 246      |
| 0x040  | UARTMIS            | 0x00000000 | RO   | Masked Interrupt Status                      | 247      |
| 0x044  | UARTICR            | 0x00000000 | W1C  | Interrupt Clear                              | 248      |
| 0xFD0  | UARTPeriphID4      | 0x00000000 | RO   | Peripheral identification 4                  | 249      |
| 0xFD4  | UARTPeriphID5      | 0x00000000 | RO   | Peripheral identification 5                  | 250      |
| 0xFD8  | UARTPeriphID6      | 0x00000000 | RO   | Peripheral identification 6                  | 251      |
| 0xFDC  | UARTPeriphID7      | 0x00000000 | RO   | Peripheral identification 7                  | 252      |
| 0xFE0  | UARTPeriphID0      | 0x00000011 | RO   | Peripheral identification 0                  | 253      |
| 0xFE4  | UARTPeriphID1      | 0x00000000 | RO   | Peripheral identification 1                  | 254      |
| 0xFE8  | UARTPeriphID2      | 0x00000018 | RO   | Peripheral identification 2                  | 255      |

Table 12-1. UART Register Map (Continued)

| Offset | Name          | Reset      | Type | Description                 | See page |
|--------|---------------|------------|------|-----------------------------|----------|
| 0xFEC  | UARTPeriphID3 | 0x00000001 | RO   | Peripheral identification 3 | 256      |
| 0xFF0  | UARTPCellID0  | 0x0000000D | RO   | PrimeCell identification 0  | 257      |
| 0xFF4  | UARTPCellID1  | 0x000000F0 | RO   | PrimeCell identification 1  | 258      |
| 0xFF8  | UARTPCellID2  | 0x00000005 | RO   | PrimeCell identification 2  | 259      |
| 0xFFC  | UARTPCellID3  | 0x000000B1 | RO   | PrimeCell identification 3  | 260      |

## 12.5 Register Descriptions

The remainder of this section lists and describes the UART registers, in numerical order by address offset.

**Register 1: UART Data (UARTDR), offset 0x000**

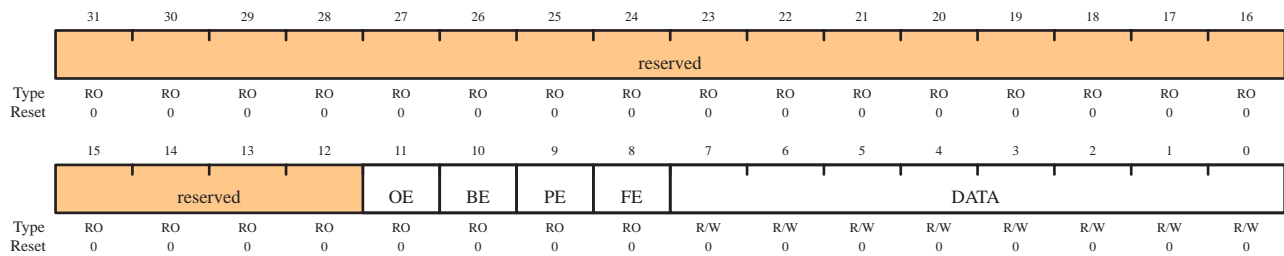
This register is the data register (the interface to the FIFOs).

When FIFOs are enabled, data written to this location is pushed onto the transmit FIFO. If FIFOs are disabled, data is stored in the transmitter holding register (the bottom word of the transmit FIFO). A write to this register initiates a transmission from the UART.

For received data, if the FIFO is enabled, the data byte and the 4-bit status (break, frame, parity and overrun) is pushed onto the 12-bit wide receive FIFO. If FIFOs are disabled, the data byte and status are stored in the receiving holding register (the bottom word of the receive FIFO). The received data can be retrieved by reading this register.

UART Data (UARTDR)

Offset 0x000



| Bit/Field | Name     | Type | Reset | Description   |
|-----------|----------|------|-------|---|
| 31:12     | reserved | RO   | 0     | Reserved bits return an indeterminate value, and should never be changed.   |
| 11        | OE       | RO   | 0     | <p>UART Overrun Error</p> <p>1=New data was received when the FIFO was full, resulting in data loss.</p> <p>0=There has been no data loss due to a FIFO overrun.</p>  |
| 10        | BE       | RO   | 0     | <p>UART Break Error</p> <p>This bit is set to 1 when a break condition is detected, indicating that the receive data input was held Low for longer than a full-word transmission time (defined as start, data, parity, and stop bits).</p> <p>In FIFO mode, this error is associated with the character at the top of the FIFO. When a break occurs, only one 0 character is loaded into the FIFO. The next character is only enabled after the received data input goes to a 1 (marking state) and the next valid start bit is received.</p> |
| 9         | PE       | RO   | 0     | <p>UART Parity Error</p> <p>This bit is set to 1 when the parity of the received data character does not match the parity defined by bits 2 and 7 of the <b>UARTLCRH</b> register.</p> <p>In FIFO mode, this error is associated with the character at the top of the FIFO.</p>   |



| Bit/Field | Name | Type | Reset | Description  |
|-----------|------|------|-------|--|
| 8         | FE   | RO   | 0     | UART Framing Error<br>This bit is set to 1 when the received character does not have a valid stop bit (a valid stop bit is 1). |
| 7:0       | DATA | R/W  | 0     | When written, the data that is to be transmitted via the UART.<br>When read, the data that was received by the UART.           |

**Register 2: UART Receive Status/Error Clear (UARTRSR/UARTECR), offset 0x004**

The **UARTRSR/UARTECR** register is the receive status register/error clear register.

In addition to the **UARTDR** register, receive status can also be read from the **UARTRSR** register. If the status is read from this register, then the status information corresponds to the entry read from **UARTDR** prior to reading **UARTRSR**. The status information for overrun is set immediately when an overrun condition occurs.

A write of any value to the **UARTECR** register clears the framing, parity, break, and overrun errors. All the bits are cleared to 0 on reset.

UART Receive Status (UARTRSR): Read

Offset 0x004

|       |          |    |    |    |    |    |    |    |    |    |    |    |    |    |    |    |
|-------|----------|----|----|----|----|----|----|----|----|----|----|----|----|----|----|----|
|       | 31       | 30 | 29 | 28 | 27 | 26 | 25 | 24 | 23 | 22 | 21 | 20 | 19 | 18 | 17 | 16 |
|       | reserved |    |    |    |    |    |    |    |    |    |    |    |    |    |    |    |
| Type  | RO       | RO | RO | RO | RO | RO | RO | RO | RO | RO | RO | RO | RO | RO | RO | RO |
| Reset | 0        | 0  | 0  | 0  | 0  | 0  | 0  | 0  | 0  | 0  | 0  | 0  | 0  | 0  | 0  | 0  |
|       | 15       | 14 | 13 | 12 | 11 | 10 | 9  | 8  | 7  | 6  | 5  | 4  | 3  | 2  | 1  | 0  |
|       | reserved |    |    |    |    |    |    |    |    |    |    |    | OE | BE | PE | FE |
| Type  | RO       | RO | RO | RO | RO | RO | RO | RO | RO | RO | RO | RO | RO | RO | RO | RO |
| Reset | 0        | 0  | 0  | 0  | 0  | 0  | 0  | 0  | 0  | 0  | 0  | 0  | 0  | 0  | 0  | 0  |

UART Error Clear (UARTECR): Write

Offset 0x004

|       |          |    |    |    |    |    |    |    |      |    |    |    |    |    |    |    |
|-------|----------|----|----|----|----|----|----|----|------|----|----|----|----|----|----|----|
|       | 31       | 30 | 29 | 28 | 27 | 26 | 25 | 24 | 23   | 22 | 21 | 20 | 19 | 18 | 17 | 16 |
|       | reserved |    |    |    |    |    |    |    |      |    |    |    |    |    |    |    |
| Type  | WO       | WO | WO | WO | WO | WO | WO | WO | WO   | WO | WO | WO | WO | WO | WO | WO |
| Reset | 0        | 0  | 0  | 0  | 0  | 0  | 0  | 0  | 0    | 0  | 0  | 0  | 0  | 0  | 0  | 0  |
|       | 15       | 14 | 13 | 12 | 11 | 10 | 9  | 8  | 7    | 6  | 5  | 4  | 3  | 2  | 1  | 0  |
|       | reserved |    |    |    |    |    |    |    | DATA |    |    |    |    |    |    |    |
| Type  | WO       | WO | WO | WO | WO | WO | WO | WO | WO   | WO | WO | WO | WO | WO | WO | WO |
| Reset | 0        | 0  | 0  | 0  | 0  | 0  | 0  | 0  | 0    | 0  | 0  | 0  | 0  | 0  | 0  | 0  |

| Bit/Field | Name | Type | Reset | Description |
|-----------|------|------|-------|-------------|
|-----------|------|------|-------|-------------|

**Read-Only Receive Status (UARTRSR) Register**

|      |          |    |   |   |
|------|----------|----|---|---|
| 31:4 | reserved | RO | 0 | Reserved bits return an indeterminate value, and should never be changed. The <b>UARTRSR</b> register cannot be written.  |
| 3    | OE       | RO | 0 | <p>UART Overrun Error</p> <p>When this bit is set to 1, data is received and the FIFO is already full. This bit is cleared to 0 by a write to <b>UARTECR</b>.</p> <p>The FIFO contents remain valid since no further data is written when the FIFO is full, only the contents of the shift register are overwritten. The CPU must now read the data in order to empty the FIFO.</p> |

| Bit/Field | Name | Type | Reset | Description   |
|-----------|------|------|-------|---|
| 2         | BE   | RO   | 0     | <p>UART Break Error</p> <p>This bit is set to 1 when a break condition is detected, indicating that the received data input was held Low for longer than a full-word transmission time (defined as start, data, parity, and stop bits).</p> <p>This bit is cleared to 0 by a write to <b>UARTECR</b>.</p> <p>In FIFO mode, this error is associated with the character at the top of the FIFO. When a break occurs, only one 0 character is loaded into the FIFO. The next character is only enabled after the receive data input goes to a 1 (marking state) and the next valid start bit is received.</p> |
| 1         | PE   | RO   | 0     | <p>UART Parity Error</p> <p>This bit is set to 1 when the parity of the received data character does not match the parity defined by bits 2 and 7 of the <b>UARTLCRH</b> register.</p> <p>This bit is cleared to 0 by a write to <b>UARTECR</b>.</p>  |
| 0         | FE   | RO   | 0     | <p>UART Framing Error</p> <p>This bit is set to 1 when the received character does not have a valid stop bit (a valid stop bit is 1).</p> <p>This bit is cleared to 0 by a write to <b>UARTECR</b>.</p> <p>In FIFO mode, this error is associated with the character at the top of the FIFO.</p>  |

#### Write-Only Error Clear (UARTECR) Register

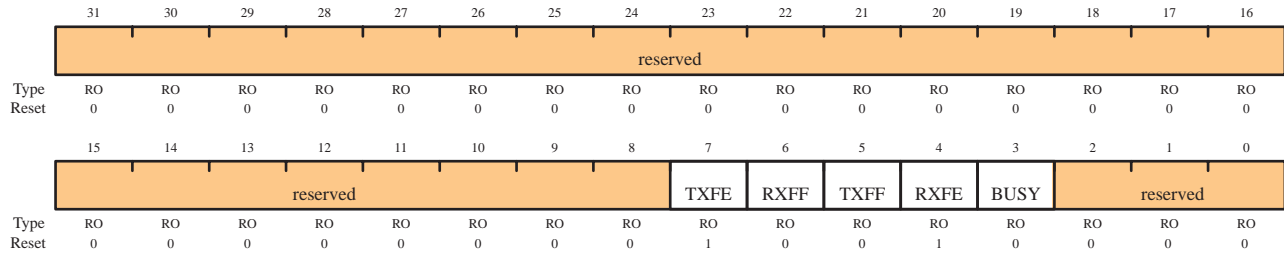
|      |          |    |   |   |
|------|----------|----|---|---|
| 31:8 | reserved | WO | 0 | Reserved bits return an indeterminate value, and should never be changed.                 |
| 7:0  | DATA     | WO | 0 | A write to this register of any data clears the framing, parity, break and overrun flags. |

**Register 3: UART Flag (UARTFR), offset 0x018**

The **UARTFR** register is the flag register. After reset, the **TXFF**, **RXFF**, and **BUSY** bits are 0, and **TXFE** and **RXFE** bits are 1.

UART Flag (UARTFR)

Offset 0x018



| Bit/Field | Name     | Type | Reset | Description   |
|-----------|----------|------|-------|---|
| 31:8      | reserved | RO   | 0     | Reserved bits return an indeterminate value, and should never be changed.   |
| 7         | TXFE     | RO   | 1     | <p>UART Transmit FIFO Empty</p> <p>The meaning of this bit depends on the state of the <i>FEN</i> bit in the <b>UARTLCRH</b> register.</p> <p>If the FIFO is disabled (<i>FEN</i> is 0), this bit is set when the transmit holding register is empty.</p> <p>If the FIFO is enabled (<i>FEN</i> is 1), this bit is set when the transmit FIFO is empty.</p> |
| 6         | RXFF     | RO   | 0     | <p>UART Receive FIFO Full</p> <p>The meaning of this bit depends on the state of the <i>FEN</i> bit in the <b>UARTLCRH</b> register.</p> <p>If the FIFO is disabled, this bit is set when the receive holding register is full.</p> <p>If the FIFO is enabled, this bit is set when the receive FIFO is full.</p>   |
| 5         | TXFF     | RO   | 0     | <p>UART Transmit FIFO Full</p> <p>The meaning of this bit depends on the state of the <i>FEN</i> bit in the <b>UARTLCRH</b> register.</p> <p>If the FIFO is disabled, this bit is set when the transmit holding register is full.</p> <p>If the FIFO is enabled, this bit is set when the transmit FIFO is full.</p>  |

---

| Bit/Field | Name     | Type | Reset | Description  |
|-----------|----------|------|-------|--|
| 4         | RXFE     | RO   | 1     | <p>UART Receive FIFO Empty</p> <p>The meaning of this bit depends on the state of the <code>FEN</code> bit in the <b>UARTLCRH</b> register.</p> <p>If the FIFO is disabled, this bit is set when the receive holding register is empty.</p> <p>If the FIFO is enabled, this bit is set when the receive FIFO is empty.</p> |
| 3         | BUSY     | RO   | 0     | <p>UART Busy</p> <p>When this bit is 1, the UART is busy transmitting data. This bit remains set until the complete byte, including all stop bits, has been sent from the shift register.</p> <p>This bit is set as soon as the transmit FIFO becomes non-empty (regardless of whether UART is enabled).</p>               |
| 2:0       | reserved | RO   | 0     | <p>Reserved bits return an indeterminate value, and should never be changed.</p>   |

**Register 4: UART Integer Baud-Rate Divisor (UARTIBRD), offset 0x024**

The **UARTIBRD** register is the integer part of the baud-rate divisor value. All the bits are cleared on reset. The minimum possible divide ratio is 1 (when **UARTIBRD=0**), in which case the **UARTFBRD** register is ignored. When changing the **UARTIBRD** register, the new value does not take effect until transmission/reception of the current character is complete. Any changes to the baud-rate divisor must be followed by a write to the **UARTLCRH** register. See “Baud-Rate Generation” on page 227 for configuration details.

UART Integer Baud-Rate Divisor

Offset 0x024

|       |          |     |     |     |     |     |     |     |     |     |     |     |     |     |     |     |
|-------|----------|-----|-----|-----|-----|-----|-----|-----|-----|-----|-----|-----|-----|-----|-----|-----|
|       | 31       | 30  | 29  | 28  | 27  | 26  | 25  | 24  | 23  | 22  | 21  | 20  | 19  | 18  | 17  | 16  |
|       | reserved |     |     |     |     |     |     |     |     |     |     |     |     |     |     |     |
| Type  | RO       | RO  | RO  | RO  | RO  | RO  | RO  | RO  | RO  | RO  | RO  | RO  | RO  | RO  | RO  | RO  |
| Reset | 0        | 0   | 0   | 0   | 0   | 0   | 0   | 0   | 0   | 0   | 0   | 0   | 0   | 0   | 0   | 0   |
|       | 15       | 14  | 13  | 12  | 11  | 10  | 9   | 8   | 7   | 6   | 5   | 4   | 3   | 2   | 1   | 0   |
|       | DIVINT   |     |     |     |     |     |     |     |     |     |     |     |     |     |     |     |
| Type  | R/W      | R/W | R/W | R/W | R/W | R/W | R/W | R/W | R/W | R/W | R/W | R/W | R/W | R/W | R/W | R/W |
| Reset | 0        | 0   | 0   | 0   | 0   | 0   | 0   | 0   | 0   | 0   | 0   | 0   | 0   | 0   | 0   | 0   |

| Bit/Field | Name     | Type | Reset  | Description   |
|-----------|----------|------|--------|---|
| 31:16     | reserved | RO   | 0      | Reserved bits return an indeterminate value, and should never be changed. |
| 15:0      | DIVINT   | R/W  | 0x0000 | Integer Baud-Rate Divisor   |

**Register 5: UART Fractional Baud-Rate Divisor (UARTFBRD), offset 0x028**

The **UARTFBRD** register is the fractional part of the baud-rate divisor value. All the bits are cleared on reset. When changing the **UARTFBRD** register, the new value does not take effect until transmission/reception of the current character is complete. Any changes to the baud-rate divisor must be followed by a write to the **UARTLCRH** register. See “Baud-Rate Generation” on page 227 for configuration details.

## UART Fractional Baud-Rate Divisor (UARTFBRD)

Offset 0x028

|       |          |    |    |    |    |    |    |    |    |    |         |     |     |     |     |     |
|-------|----------|----|----|----|----|----|----|----|----|----|---------|-----|-----|-----|-----|-----|
|       | 31       | 30 | 29 | 28 | 27 | 26 | 25 | 24 | 23 | 22 | 21      | 20  | 19  | 18  | 17  | 16  |
|       | reserved |    |    |    |    |    |    |    |    |    |         |     |     |     |     |     |
| Type  | RO       | RO | RO | RO | RO | RO | RO | RO | RO | RO | RO      | RO  | RO  | RO  | RO  | RO  |
| Reset | 0        | 0  | 0  | 0  | 0  | 0  | 0  | 0  | 0  | 0  | 0       | 0   | 0   | 0   | 0   | 0   |
|       | 15       | 14 | 13 | 12 | 11 | 10 | 9  | 8  | 7  | 6  | 5       | 4   | 3   | 2   | 1   | 0   |
|       | reserved |    |    |    |    |    |    |    |    |    | DIVFRAC |     |     |     |     |     |
| Type  | RO       | RO | RO | RO | RO | RO | RO | RO | RO | RO | R/W     | R/W | R/W | R/W | R/W | R/W |
| Reset | 0        | 0  | 0  | 0  | 0  | 0  | 0  | 0  | 0  | 0  | 0       | 0   | 0   | 0   | 0   | 0   |

| Bit/Field | Name     | Type | Reset | Description   |
|-----------|----------|------|-------|---|
| 31:6      | reserved | RO   | 0     | Reserved bits return an indeterminate value, and should never be changed. |
| 5:0       | DIVFRAC  | R/W  | 0x00  | Fractional Baud-Rate Divisor  |

**Register 6: UART Line Control (UARTLCRH), offset 0x02C**

The **UARTLCRH** register is the line control register. Serial parameters such as data length, parity and stop bit selection are implemented in this register.

When updating the baud-rate divisor (**UARTIBRD** and/or **UARTIFRD**), the **UARTLCRH** register must also be written. The write strobe for the baud-rate divisor registers is tied to the **UARTLCRH** register.

UART Line Control (UARTLCRH)

Offset 0x02C

|       |          |    |    |    |    |    |    |    |     |      |     |     |      |     |     |     |   |
|-------|----------|----|----|----|----|----|----|----|-----|------|-----|-----|------|-----|-----|-----|---|
|       | 31       | 30 | 29 | 28 | 27 | 26 | 25 | 24 | 23  | 22   | 21  | 20  | 19   | 18  | 17  | 16  |   |
|       | reserved |    |    |    |    |    |    |    |     |      |     |     |      |     |     |     |   |
| Type  | RO       | RO | RO | RO | RO | RO | RO | RO | RO  | RO   | RO  | RO  | RO   | RO  | RO  | RO  |   |
| Reset | 0        | 0  | 0  | 0  | 0  | 0  | 0  | 0  | 0   | 0    | 0   | 0   | 0    | 0   | 0   | 0   |   |
|       | 15       | 14 | 13 | 12 | 11 | 10 | 9  | 8  | 7   | 6    | 5   | 4   | 3    | 2   | 1   | 0   |   |
|       | reserved |    |    |    |    |    |    |    | SPS | WLEN |     | FEN | STP2 | EPS | PEN | BRK |   |
| Type  | RO       | RO | RO | RO | RO | RO | RO | RO | R/W | R/W  | R/W | R/W | R/W  | R/W | R/W | R/W |   |
| Reset | 0        | 0  | 0  | 0  | 0  | 0  | 0  | 0  | 0   | 0    | 0   | 0   | 0    | 0   | 0   | 0   | 0 |

| Bit/Field | Name     | Type | Reset | Description  |
|-----------|----------|------|-------|--|
| 31:8      | reserved | RO   | 0     | Reserved bits return an indeterminate value, and should never be changed.  |
| 7         | SPS      | R/W  | 0     | <p>UART Stick Parity Select</p> <p>When bits 1, 2 and 7 of <b>UARTLCRH</b> are set, the parity bit is transmitted and checked as a 0. When bits 1 and 7 are set and 2 is cleared, the parity bit is transmitted and checked as a 1.</p> <p>When this bit is cleared, stick parity is disabled.</p> |
| 6:5       | WLEN     | R/W  | 0     | <p>UART Word Length</p> <p>The bits indicate the number of data bits transmitted or received in a frame as follows:</p> <p>0x3: 8 bits</p> <p>0x2: 7 bits</p> <p>0x1: 6 bits</p> <p>0x0: 5 bits (default)</p>  |
| 4         | FEN      | R/W  | 0     | <p>UART Enable FIFOs</p> <p>If this bit is set to 1, transmit and receive FIFO buffers are enabled (FIFO mode).</p> <p>When cleared to 0, FIFOs are disabled (Character mode). The FIFOs become 1-byte-deep holding registers.</p>   |
| 3         | STP2     | R/W  | 0     | <p>UART Two Stop Bits Select</p> <p>If this bit is set to 1, two stop bits are transmitted at the end of a frame. The receive logic does not check for two stop bits being received.</p>   |



---

| Bit/Field | Name | Type | Reset | Description   |
|-----------|------|------|-------|---|
| 2         | EPS  | R/W  | 0     | <p>UART Even Parity Select</p> <p>If this bit is set to 1, even parity generation and checking is performed during transmission and reception, which checks for an even number of 1s in data and parity bits.</p> <p>When cleared to 0, then odd parity is performed, which checks for an odd number of 1s.</p> <p>This bit has no effect when parity is disabled by the PEN bit.</p> |
| 1         | PEN  | R/W  | 0     | <p>UART Parity Enable</p> <p>If this bit is set to 1, parity checking and generation is enabled; otherwise, parity is disabled and no parity bit is added to the data frame.</p>  |
| 0         | BRK  | R/W  | 0     | <p>UART Send Break</p> <p>If this bit is set to 1, a Low level is continually output on the <math>U_{nTX}</math> output, after completing transmission of the current character. For the proper execution of the break command, the software must set this bit for at least two frames (character periods). For normal use, this bit must be cleared to 0.</p>                        |

**Register 7: UART Control (UARTCTL), offset 0x030**

The **UARTCTL** register is the control register. All the bits are cleared on reset except for the Transmit Enable (TXE) and Receive Enable (RXE) bits, which are set to 1.

To enable the UART module, the **UARTEN** bit must be set to 1. If software requires a configuration change in the module, the **UARTEN** bit must be cleared before the configuration changes are written. If the UART is disabled during a transmit or receive operation, the current transaction is completed prior to the UART stopping.

UART Control (UARTCR)

Offset 0x030

|       |          |    |    |    |    |    |     |     |     |          |    |    |    |    |    |        |
|-------|----------|----|----|----|----|----|-----|-----|-----|----------|----|----|----|----|----|--------|
|       | 31       | 30 | 29 | 28 | 27 | 26 | 25  | 24  | 23  | 22       | 21 | 20 | 19 | 18 | 17 | 16     |
|       | reserved |    |    |    |    |    |     |     |     |          |    |    |    |    |    |        |
| Type  | RO       | RO | RO | RO | RO | RO | RO  | RO  | RO  | RO       | RO | RO | RO | RO | RO | RO     |
| Reset | 0        | 0  | 0  | 0  | 0  | 0  | 0   | 0   | 0   | 0        | 0  | 0  | 0  | 0  | 0  | 0      |
|       | 15       | 14 | 13 | 12 | 11 | 10 | 9   | 8   | 7   | 6        | 5  | 4  | 3  | 2  | 1  | 0      |
|       | reserved |    |    |    |    |    | RXE | TXE | LBE | reserved |    |    |    |    |    | UARTEN |
| Type  | RO       | RO | RO | RO | RO | RO | R/W | R/W | R/W | RO       | RO | RO | RO | RO | RO | R/W    |
| Reset | 0        | 0  | 0  | 0  | 0  | 0  | 1   | 1   | 0   | 0        | 0  | 0  | 0  | 0  | 0  | 0      |

| Bit/Field | Name     | Type | Reset | Description  |
|-----------|----------|------|-------|--|
| 31:10     | reserved | RO   | 0     | Reserved bits return an indeterminate value, and should never be changed.  |
| 9         | RXE      | R/W  | 1     | UART Receive Enable<br>If this bit is set to 1, the receive section of the UART is enabled. When the UART is disabled in the middle of a receive, it completes the current character before stopping.        |
| 8         | TXE      | R/W  | 1     | UART Transmit Enable<br>If this bit is set to 1, the transmit section of the UART is enabled. When the UART is disabled in the middle of a transmission, it completes the current character before stopping. |
| 7         | LBE      | R/W  | 0     | UART Loop Back Enable<br>If this bit is set to 1, the $U_{nTX}$ path is fed through the $U_{nRX}$ path.  |
| 6:1       | reserved | RO   | 0     | Reserved bits return an indeterminate value, and should never be changed.  |
| 0         | UARTEN   | R/W  | 0     | UART Enable<br>If this bit is set to 1, the UART is enabled. When the UART is disabled in the middle of transmission or reception, it completes the current character before stopping.                       |

**Register 8: UART Interrupt FIFO Level Select (UARTIFLS), offset 0x034**

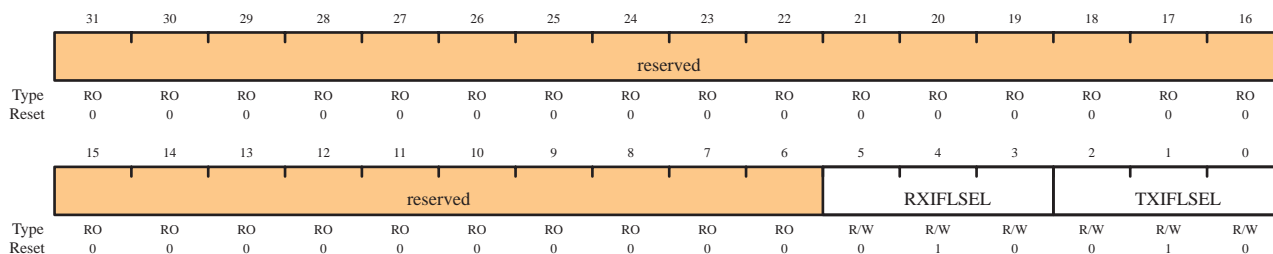
The **UARTIFLS** register is the interrupt FIFO level select register. You can use this register to define the FIFO level at which the **TXRIS** and **RXRIS** bits in the **UARTRIS** register are triggered.

The interrupts are generated based on a transition through a level rather than being based on the level. That is, the interrupts are generated when the fill level progresses through the trigger level. For example, if the receive trigger level is set to the half-way mark, the interrupt is triggered as the module is receiving the 9th character.

Out of reset, the **TXIFLSEL** and **RXIFLSEL** bits are configured so that the FIFOs trigger an interrupt at the half-way mark.

UART Interrupt FIFO Level Select (UARTIFLS)

Offset 0x034



| Bit/Field | Name     | Type | Reset | Description  |
|-----------|----------|------|-------|--|
| 31:6      | reserved | RO   | 0     | Reserved bits return an indeterminate value, and should never be changed.  |
| 5:3       | RXIFLSEL | R/W  | 0X2   | UART Receive Interrupt FIFO Level Select<br>The trigger points for the receive interrupt are as follows:<br>000: RX FIFO ≥ 1/8 full<br>001: RX FIFO ≥ 1/4 full<br>010: RX FIFO ≥ 1/2 full (default)<br>011: RX FIFO ≥ 3/4 full<br>100: RX FIFO ≥ 7/8 full<br>101-111: Reserved   |
| 2:0       | TXIFLSEL | R/W  | 0X2   | UART Transmit Interrupt FIFO Level Select<br>The trigger points for the transmit interrupt are as follows:<br>000: TX FIFO ≤ 1/8 full<br>001: TX FIFO ≤ 1/4 full<br>010: TX FIFO ≤ 1/2 full (default)<br>011: TX FIFO ≤ 3/4 full<br>100: TX FIFO ≤ 7/8 full<br>101-111: Reserved |

**Register 9: UART Interrupt Mask (UARTIM), offset 0x038**

The **UARTIM** register is the interrupt mask set/clear register.

On a read, this register gives the current value of the mask on the relevant interrupt. Writing a 1 to a bit allows the corresponding raw interrupt signal to be routed to the interrupt controller. Writing a 0 prevents the raw interrupt signal from being sent to the interrupt controller.

UART Interrupt Mask (UARTIM)

Offset 0x038

|       |          |    |    |    |    |      |      |      |      |      |      |      |          |    |    |    |
|-------|----------|----|----|----|----|------|------|------|------|------|------|------|----------|----|----|----|
|       | 31       | 30 | 29 | 28 | 27 | 26   | 25   | 24   | 23   | 22   | 21   | 20   | 19       | 18 | 17 | 16 |
|       | reserved |    |    |    |    |      |      |      |      |      |      |      |          |    |    |    |
| Type  | RO       | RO | RO | RO | RO | RO   | RO   | RO   | RO   | RO   | RO   | RO   | RO       | RO | RO | RO |
| Reset | 0        | 0  | 0  | 0  | 0  | 0    | 0    | 0    | 0    | 0    | 0    | 0    | 0        | 0  | 0  | 0  |
|       | 15       | 14 | 13 | 12 | 11 | 10   | 9    | 8    | 7    | 6    | 5    | 4    | 3        | 2  | 1  | 0  |
|       | reserved |    |    |    |    | OEIM | BEIM | PEIM | FEIM | RTIM | TXIM | RXIM | reserved |    |    |    |
| Type  | RO       | RO | RO | RO | RO | R/W  | R/W  | R/W  | R/W  | R/W  | R/W  | R/W  | RO       | RO | RO | RO |
| Reset | 0        | 0  | 0  | 0  | 0  | 0    | 0    | 0    | 0    | 0    | 0    | 0    | 0        | 0  | 0  | 0  |

| Bit/Field | Name     | Type | Reset | Description   |
|-----------|----------|------|-------|---|
| 31:11     | reserved | RO   | 0     | Reserved bits return an indeterminate value, and should never be changed.   |
| 10        | OEIM     | R/W  | 0     | <p>UART Overrun Error Interrupt Mask</p> <p>On a read, the current mask for the OEIM interrupt is returned. Setting this bit to 1 promotes the OEIM interrupt to the interrupt controller.</p>    |
| 9         | BEIM     | R/W  | 0     | <p>UART Break Error Interrupt Mask</p> <p>On a read, the current mask for the BEIM interrupt is returned. Setting this bit to 1 promotes the BEIM interrupt to the interrupt controller.</p>      |
| 8         | PEIM     | R/W  | 0     | <p>UART Parity Error Interrupt Mask</p> <p>On a read, the current mask for the PEIM interrupt is returned. Setting this bit to 1 promotes the PEIM interrupt to the interrupt controller.</p>     |
| 7         | FEIM     | R/W  | 0     | <p>UART Framing Error Interrupt Mask</p> <p>On a read, the current mask for the FEIM interrupt is returned. Setting this bit to 1 promotes the FEIM interrupt to the interrupt controller.</p>    |
| 6         | RTIM     | R/W  | 0     | <p>UART Receive Time-Out Interrupt Mask</p> <p>On a read, the current mask for the RTIM interrupt is returned. Setting this bit to 1 promotes the RTIM interrupt to the interrupt controller.</p> |

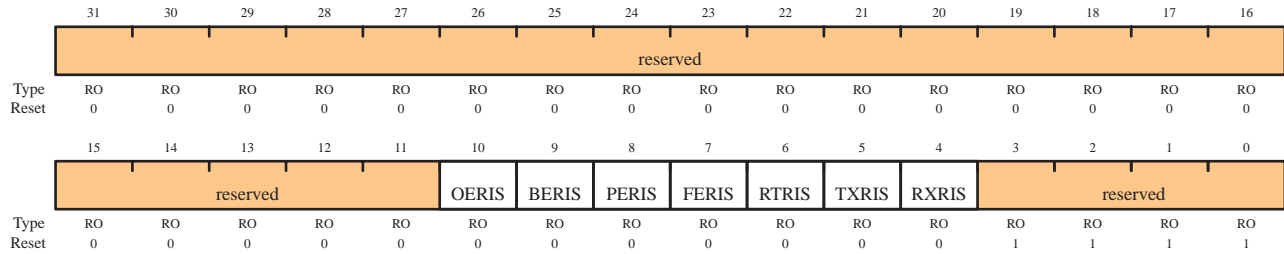
| Bit/Field | Name     | Type | Reset | Description   |
|-----------|----------|------|-------|---|
| 5         | TXIM     | R/W  | 0     | UART Transmit Interrupt Mask<br>On a read, the current mask for the TXIM interrupt is returned.<br>Setting this bit to 1 promotes the TXIM interrupt to the interrupt controller. |
| 4         | RXIM     | R/W  | 0     | UART Receive Interrupt Mask<br>On a read, the current mask for the RXIM interrupt is returned.<br>Setting this bit to 1 promotes the RXIM interrupt to the interrupt controller.  |
| 3:0       | reserved | RO   | 0     | Reserved bits return an indeterminate value, and should never be changed.   |

**Register 10: UART Raw Interrupt Status (UARTRIS), offset 0x03C**

The **UARTRIS** register is the raw interrupt status register. On a read, this register gives the current raw status value of the corresponding interrupt. A write has no effect.

UART Raw Interrupt Status (UARTRIS)

Offset 0x03C



| Bit/Field | Name     | Type | Reset | Description   |
|-----------|----------|------|-------|---|
| 31:11     | reserved | RO   | 0     | Reserved bits return an indeterminate value, and should never be changed.   |
| 10        | OERIS    | RO   | 0     | UART Overrun Error Raw Interrupt Status<br>Gives the raw interrupt state (prior to masking) of this interrupt.    |
| 9         | BERIS    | RO   | 0     | UART Break Error Raw Interrupt Status<br>Gives the raw interrupt state (prior to masking) of this interrupt.      |
| 8         | PERIS    | RO   | 0     | UART Parity Error Raw Interrupt Status<br>Gives the raw interrupt state (prior to masking) of this interrupt.     |
| 7         | FERIS    | RO   | 0     | UART Framing Error Raw Interrupt Status<br>Gives the raw interrupt state (prior to masking) of this interrupt.    |
| 6         | RTRIS    | RO   | 0     | UART Receive Time-Out Raw Interrupt Status<br>Gives the raw interrupt state (prior to masking) of this interrupt. |
| 5         | TXRIS    | RO   | 0     | UART Transmit Raw Interrupt Status<br>Gives the raw interrupt state (prior to masking) of this interrupt.         |
| 4         | RXRIS    | RO   | 0     | UART Receive Raw Interrupt Status<br>Gives the raw interrupt state (prior to masking) of this interrupt.          |
| 3:0       | reserved | RO   | 0xF   | This reserved bit is read-only and has a reset value of 0xF.  |

**Register 11: UART Masked Interrupt Status (UARTMIS), offset 0x040**

The **UARTMIS** register is the masked interrupt status register. On a read, this register gives the current masked status value of the corresponding interrupt. A write has no effect.

## UART Masked Interrupt Status (UARTMIS)

Offset 0x040

|       |          |    |    |    |    |       |       |       |       |       |       |       |          |    |    |    |
|-------|----------|----|----|----|----|-------|-------|-------|-------|-------|-------|-------|----------|----|----|----|
|       | 31       | 30 | 29 | 28 | 27 | 26    | 25    | 24    | 23    | 22    | 21    | 20    | 19       | 18 | 17 | 16 |
|       | reserved |    |    |    |    |       |       |       |       |       |       |       |          |    |    |    |
| Type  | RO       | RO | RO | RO | RO | RO    | RO    | RO    | RO    | RO    | RO    | RO    | RO       | RO | RO | RO |
| Reset | 0        | 0  | 0  | 0  | 0  | 0     | 0     | 0     | 0     | 0     | 0     | 0     | 0        | 0  | 0  | 0  |
|       | 15       | 14 | 13 | 12 | 11 | 10    | 9     | 8     | 7     | 6     | 5     | 4     | 3        | 2  | 1  | 0  |
|       | reserved |    |    |    |    | OEMIS | BEMIS | PEMIS | FEMIS | RTMIS | TXMIS | RXMIS | reserved |    |    |    |
| Type  | RO       | RO | RO | RO | RO | RO    | RO    | RO    | RO    | RO    | RO    | RO    | RO       | RO | RO | RO |
| Reset | 0        | 0  | 0  | 0  | 0  | 0     | 0     | 0     | 0     | 0     | 0     | 0     | 0        | 0  | 0  | 0  |

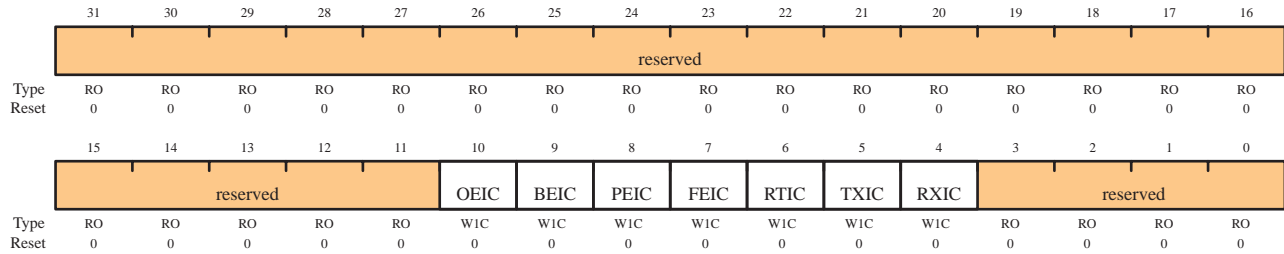
| Bit/Field | Name     | Type | Reset | Description  |
|-----------|----------|------|-------|--|
| 31:11     | reserved | RO   | 0     | Reserved bits return an indeterminate value, and should never be changed.                            |
| 10        | OEMIS    | RO   | 0     | UART Overrun Error Masked Interrupt Status<br>Gives the masked interrupt state of this interrupt.    |
| 9         | BEMIS    | RO   | 0     | UART Break Error Masked Interrupt Status<br>Gives the masked interrupt state of this interrupt.      |
| 8         | PEMIS    | RO   | 0     | UART Parity Error Masked Interrupt Status<br>Gives the masked interrupt state of this interrupt.     |
| 7         | FEMIS    | RO   | 0     | UART Framing Error Masked Interrupt Status<br>Gives the masked interrupt state of this interrupt.    |
| 6         | RTMIS    | RO   | 0     | UART Receive Time-Out Masked Interrupt Status<br>Gives the masked interrupt state of this interrupt. |
| 5         | TXMIS    | RO   | 0     | UART Transmit Masked Interrupt Status<br>Gives the masked interrupt state of this interrupt.         |
| 4         | RXMIS    | RO   | 0     | UART Receive Masked Interrupt Status<br>Gives the masked interrupt state of this interrupt.          |
| 3:0       | reserved | RO   | 0     | Reserved bits return an indeterminate value, and should never be changed.                            |

**Register 12: UART Interrupt Clear (UARTICR), offset 0x044**

The **UARTICR** register is the interrupt clear register. On a write of 1, the corresponding interrupt (both raw interrupt and masked interrupt, if enabled) is cleared. A write of 0 has no effect.

UART Interrupt Clear (UARTICR)

Offset 0x044



| Bit/Field | Name     | Type | Reset | Description  |
|-----------|----------|------|-------|--|
| 31:11     | reserved | RO   | 0     | Reserved bits return an indeterminate value, and should never be changed.                  |
| 10        | OEIC     | W1C  | 0     | Overrun Error Interrupt Clear<br>0: No effect on the interrupt.<br>1: Clears interrupt.    |
| 9         | BEIC     | W1C  | 0     | Break Error Interrupt Clear<br>0: No effect on the interrupt.<br>1: Clears interrupt.      |
| 8         | PEIC     | W1C  | 0     | Parity Error Interrupt Clear<br>0: No effect on the interrupt.<br>1: Clears interrupt.     |
| 7         | FEIC     | W1C  | 0     | Framing Error Interrupt Clear<br>0: No effect on the interrupt.<br>1: Clears interrupt.    |
| 6         | RTIC     | W1C  | 0     | Receive Time-Out Interrupt Clear<br>0: No effect on the interrupt.<br>1: Clears interrupt. |
| 5         | TXIC     | W1C  | 0     | Transmit Interrupt Clear<br>0: No effect on the interrupt.<br>1: Clears interrupt.         |
| 4         | RXIC     | W1C  | 0     | Receive Interrupt Clear<br>0: No effect on the interrupt.<br>1: Clears interrupt.          |
| 3:0       | reserved | RO   | 0     | Reserved bits return an indeterminate value, and should never be changed.                  |

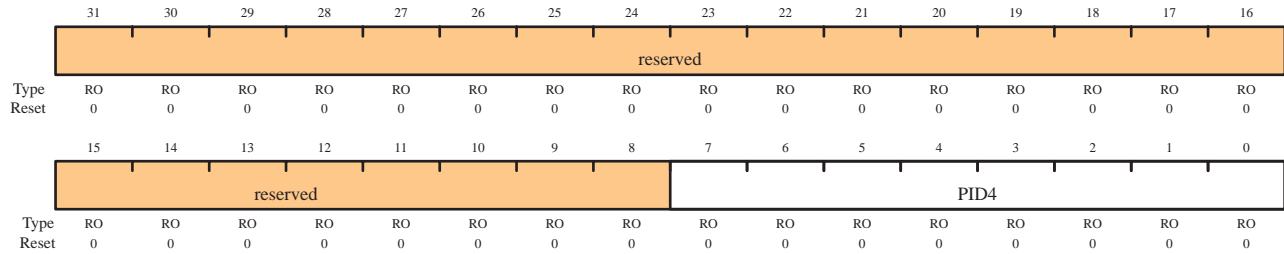


**Register 13: UART Peripheral Identification 4 (UARTPeriphID4), offset 0xFD0**

The **UARTPeriphIDn** registers are hard-coded and the fields within the registers determine the reset values.

UART Peripheral Identification 4 (UARTPeriphID4)

Offset 0xFD0



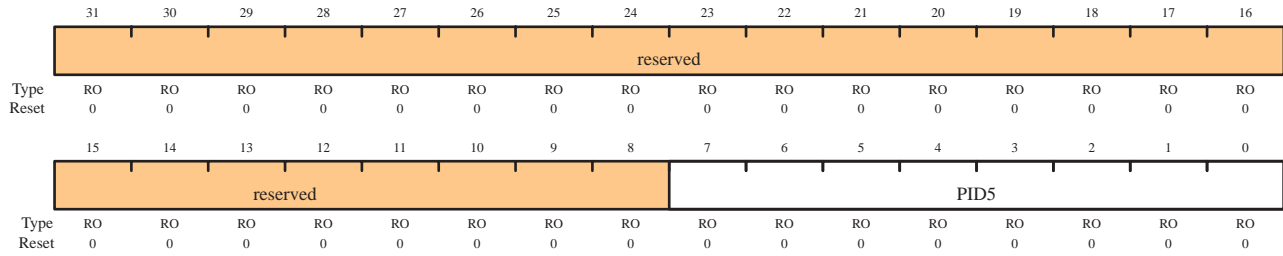
| Bit/Field | Name     | Type | Reset | Description   |
|-----------|----------|------|-------|---|
| 31:8      | reserved | RO   | 0     | Reserved bits return an indeterminate value, and should never be changed. |
| 7:0       | PID4     | RO   | 0x00  | UART Peripheral ID Register[7:0]  |

**Register 14: UART Peripheral Identification 5 (UARTPeriphID5), offset 0xFD4**

The **UARTPeriphIDn** registers are hard-coded and the fields within the registers determine the reset values.

UART Peripheral Identification 5 (UARTPeriphID5)

Offset 0xFD4



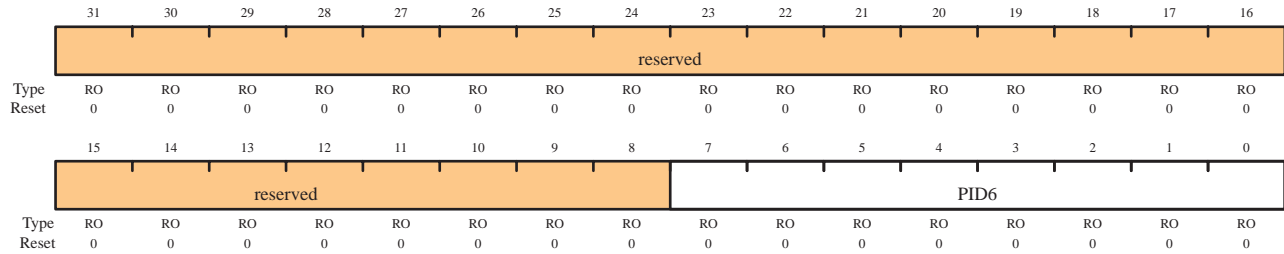
| Bit/Field | Name     | Type | Reset | Description   |
|-----------|----------|------|-------|---|
| 31:8      | reserved | RO   | 0     | Reserved bits return an indeterminate value, and should never be changed. |
| 7:0       | PID5     | RO   | 0x00  | UART Peripheral ID Register[15:8]   |

**Register 15: UART Peripheral Identification 6 (UARTPeriphID6), offset 0xFD8**

The **UARTPeriphIDn** registers are hard-coded and the fields within the registers determine the reset values.

UART Peripheral Identification 6 (UARTPeriphID6)

Offset 0xFD8



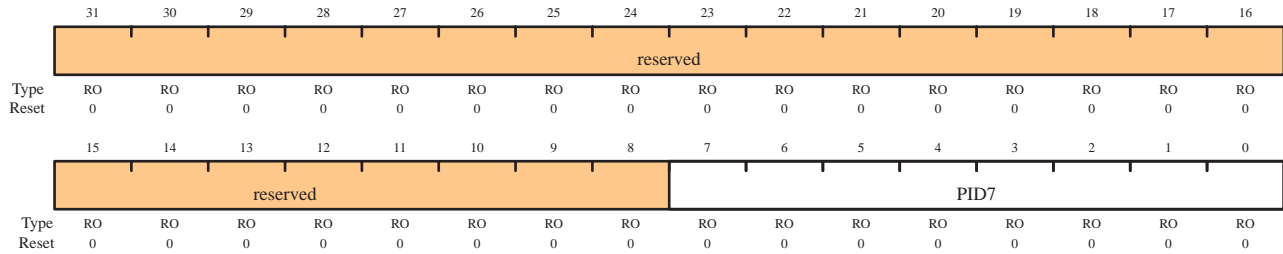
| Bit/Field | Name     | Type | Reset | Description   |
|-----------|----------|------|-------|---|
| 31:8      | reserved | RO   | 0     | Reserved bits return an indeterminate value, and should never be changed. |
| 7:0       | PID6     | RO   | 0x00  | UART Peripheral ID Register[23:16]  |

**Register 16: UART Peripheral Identification 7 (UARTPeriphID7), offset 0xFDC**

The **UARTPeriphIDn** registers are hard-coded and the fields within the registers determine the reset values.

UART Peripheral Identification 7 (UARTPeriphID7)

Offset 0xFDC



| Bit/Field | Name     | Type | Reset | Description   |
|-----------|----------|------|-------|---|
| 31:8      | reserved | RO   | 0     | Reserved bits return an indeterminate value, and should never be changed. |
| 7:0       | PID7     | RO   | 0x00  | UART Peripheral ID Register[31:24]  |

**Register 17: UART Peripheral Identification 0 (UARTPeriphID0), offset 0xFE0**

The **UARTPeriphIDn** registers are hard-coded and the fields within the registers determine the reset values.

## UART Peripheral Identification 0 (UARTPeriphID0)

Offset 0xFE0

|       |          |    |    |    |    |    |    |    |      |    |    |    |    |    |    |    |
|-------|----------|----|----|----|----|----|----|----|------|----|----|----|----|----|----|----|
|       | 31       | 30 | 29 | 28 | 27 | 26 | 25 | 24 | 23   | 22 | 21 | 20 | 19 | 18 | 17 | 16 |
|       | reserved |    |    |    |    |    |    |    |      |    |    |    |    |    |    |    |
| Type  | RO       | RO | RO | RO | RO | RO | RO | RO | RO   | RO | RO | RO | RO | RO | RO | RO |
| Reset | 0        | 0  | 0  | 0  | 0  | 0  | 0  | 0  | 0    | 0  | 0  | 0  | 0  | 0  | 0  | 0  |
|       | 15       | 14 | 13 | 12 | 11 | 10 | 9  | 8  | 7    | 6  | 5  | 4  | 3  | 2  | 1  | 0  |
|       | reserved |    |    |    |    |    |    |    | PID0 |    |    |    |    |    |    |    |
| Type  | RO       | RO | RO | RO | RO | RO | RO | RO | RO   | RO | RO | RO | RO | RO | RO | RO |
| Reset | 0        | 0  | 0  | 0  | 0  | 0  | 0  | 0  | 0    | 0  | 0  | 1  | 0  | 0  | 0  | 1  |

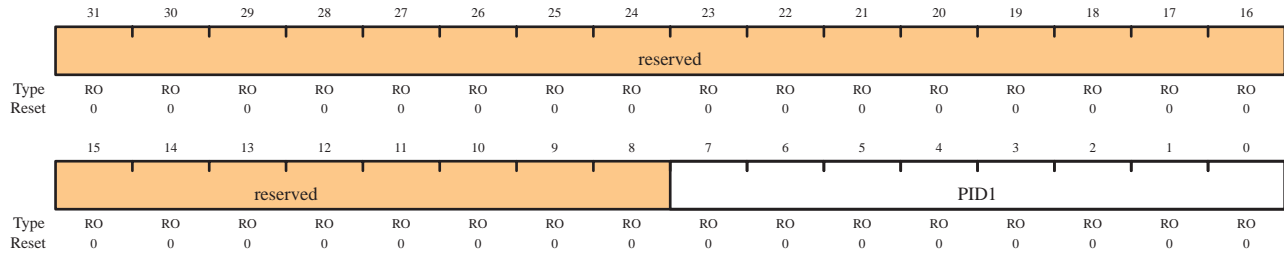
| Bit/Field | Name     | Type | Reset | Description  |
|-----------|----------|------|-------|--|
| 31:8      | reserved | RO   | 0     | Reserved bits return an indeterminate value, and should never be changed.                                |
| 7:0       | PID0     | RO   | 0x11  | UART Peripheral ID Register[7:0]<br>Can be used by software to identify the presence of this peripheral. |

**Register 18: UART Peripheral Identification 1 (UARTPeriphID1), offset 0xFE4**

The **UARTPeriphIDn** registers are hard-coded and the fields within the registers determine the reset values.

UART Peripheral Identification 1 (UARTPeriphID1)

Offset 0xFE4



| Bit/Field | Name     | Type | Reset | Description   |
|-----------|----------|------|-------|---|
| 31:8      | reserved | RO   | 0     | Reserved bits return an indeterminate value, and should never be changed.                                 |
| 7:0       | PID1     | RO   | 0x00  | UART Peripheral ID Register[15:8]<br>Can be used by software to identify the presence of this peripheral. |

**Register 19: UART Peripheral Identification 2 (UARTPeriphID2), offset 0xFE8**

The **UARTPeriphIDn** registers are hard-coded and the fields within the registers determine the reset values.

## UART Peripheral Identification 2 (UARTPeriphID2)

Offset 0xFE8

|       |          |    |    |    |    |    |    |    |      |    |    |    |    |    |    |    |
|-------|----------|----|----|----|----|----|----|----|------|----|----|----|----|----|----|----|
|       | 31       | 30 | 29 | 28 | 27 | 26 | 25 | 24 | 23   | 22 | 21 | 20 | 19 | 18 | 17 | 16 |
|       | reserved |    |    |    |    |    |    |    |      |    |    |    |    |    |    |    |
| Type  | RO       | RO | RO | RO | RO | RO | RO | RO | RO   | RO | RO | RO | RO | RO | RO | RO |
| Reset | 0        | 0  | 0  | 0  | 0  | 0  | 0  | 0  | 0    | 0  | 0  | 0  | 0  | 0  | 0  | 0  |
|       | 15       | 14 | 13 | 12 | 11 | 10 | 9  | 8  | 7    | 6  | 5  | 4  | 3  | 2  | 1  | 0  |
|       | reserved |    |    |    |    |    |    |    | PID2 |    |    |    |    |    |    |    |
| Type  | RO       | RO | RO | RO | RO | RO | RO | RO | RO   | RO | RO | RO | RO | RO | RO | RO |
| Reset | 0        | 0  | 0  | 0  | 0  | 0  | 0  | 0  | 0    | 0  | 0  | 1  | 1  | 0  | 0  | 0  |

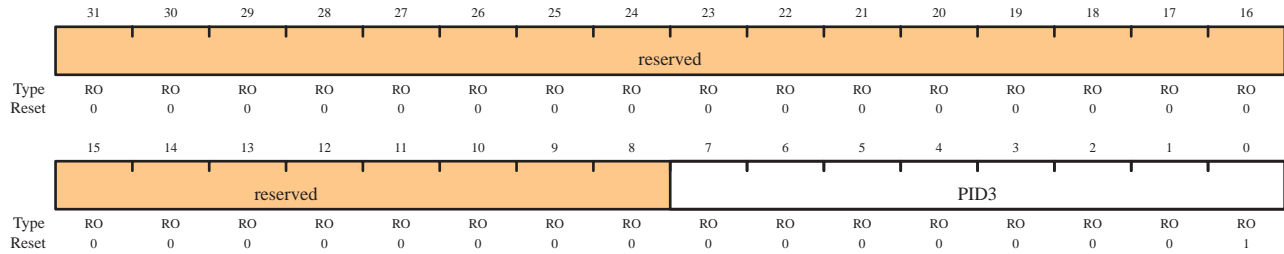
| Bit/Field | Name     | Type | Reset | Description  |
|-----------|----------|------|-------|--|
| 31:8      | reserved | RO   | 0     | Reserved bits return an indeterminate value, and should never be changed.                                  |
| 7:0       | PID2     | RO   | 0x18  | UART Peripheral ID Register[23:16]<br>Can be used by software to identify the presence of this peripheral. |

**Register 20: UART Peripheral Identification 3 (UARTPeriphID3), offset 0xFEC**

The **UARTPeriphIDn** registers are hard-coded and the fields within the registers determine the reset values.

UART Peripheral Identification 3 (UARTPeriphID3)

Offset 0xFEC



| Bit/Field | Name     | Type | Reset | Description  |
|-----------|----------|------|-------|--|
| 31:8      | reserved | RO   | 0     | Reserved bits return an indeterminate value, and should never be changed.                                  |
| 7:0       | PID3     | RO   | 0x01  | UART Peripheral ID Register[31:24]<br>Can be used by software to identify the presence of this peripheral. |



**Register 21: UART PrimeCell Identification 0 (UARTPCellID0), offset 0xFF0**

The **UARTPCellIDn** registers are hard-coded and the fields within the registers determine the reset values.

## UART Primecell Identification 0 (UARTPCellID0)

Offset 0xFF0

|       |          |    |    |    |    |    |    |    |      |    |    |    |    |    |    |    |
|-------|----------|----|----|----|----|----|----|----|------|----|----|----|----|----|----|----|
|       | 31       | 30 | 29 | 28 | 27 | 26 | 25 | 24 | 23   | 22 | 21 | 20 | 19 | 18 | 17 | 16 |
|       | reserved |    |    |    |    |    |    |    |      |    |    |    |    |    |    |    |
| Type  | RO       | RO | RO | RO | RO | RO | RO | RO | RO   | RO | RO | RO | RO | RO | RO | RO |
| Reset | 0        | 0  | 0  | 0  | 0  | 0  | 0  | 0  | 0    | 0  | 0  | 0  | 0  | 0  | 0  | 0  |
|       | 15       | 14 | 13 | 12 | 11 | 10 | 9  | 8  | 7    | 6  | 5  | 4  | 3  | 2  | 1  | 0  |
|       | reserved |    |    |    |    |    |    |    | CID0 |    |    |    |    |    |    |    |
| Type  | RO       | RO | RO | RO | RO | RO | RO | RO | RO   | RO | RO | RO | RO | RO | RO | RO |
| Reset | 0        | 0  | 0  | 0  | 0  | 0  | 0  | 0  | 0    | 0  | 0  | 0  | 1  | 1  | 0  | 1  |

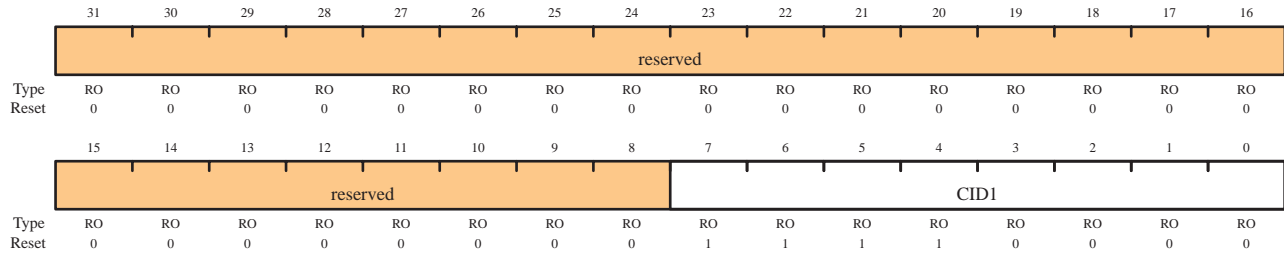
| Bit/Field | Name     | Type | Reset | Description   |
|-----------|----------|------|-------|---|
| 31:8      | reserved | RO   | 0     | Reserved bits return an indeterminate value, and should never be changed.                               |
| 7:0       | CID0     | RO   | 0x0D  | UART PrimeCell ID Register[7:0]<br>Provides software a standard cross-peripheral identification system. |

**Register 22: UART PrimeCell Identification 1 (UARTPCelIID1), offset 0xFF4**

The **UARTPCelIIDn** registers are hard-coded and the fields within the registers determine the reset values.

UART Primecell Identification 1 (UARTPCelIID1)

Offset 0xFF4



| Bit/Field | Name     | Type | Reset | Description  |
|-----------|----------|------|-------|--|
| 31:8      | reserved | RO   | 0     | Reserved bits return an indeterminate value, and should never be changed.                                |
| 7:0       | CID1     | RO   | 0xF0  | UART PrimeCell ID Register[15:8]<br>Provides software a standard cross-peripheral identification system. |

**Register 23: UART PrimeCell Identification 2 (UARTPCelIID2), offset 0xFF8**

The **UARTPCelIIDn** registers are hard-coded and the fields within the registers determine the reset values.

UART Primecell Identification 2 (UARTPCelIID2)

Offset 0xFF8

|       |          |    |    |    |    |    |    |    |      |    |    |    |    |    |    |    |
|-------|----------|----|----|----|----|----|----|----|------|----|----|----|----|----|----|----|
|       | 31       | 30 | 29 | 28 | 27 | 26 | 25 | 24 | 23   | 22 | 21 | 20 | 19 | 18 | 17 | 16 |
|       | reserved |    |    |    |    |    |    |    |      |    |    |    |    |    |    |    |
| Type  | RO       | RO | RO | RO | RO | RO | RO | RO | RO   | RO | RO | RO | RO | RO | RO | RO |
| Reset | 0        | 0  | 0  | 0  | 0  | 0  | 0  | 0  | 0    | 0  | 0  | 0  | 0  | 0  | 0  | 0  |
|       | 15       | 14 | 13 | 12 | 11 | 10 | 9  | 8  | 7    | 6  | 5  | 4  | 3  | 2  | 1  | 0  |
|       | reserved |    |    |    |    |    |    |    | CID2 |    |    |    |    |    |    |    |
| Type  | RO       | RO | RO | RO | RO | RO | RO | RO | RO   | RO | RO | RO | RO | RO | RO | RO |
| Reset | 0        | 0  | 0  | 0  | 0  | 0  | 0  | 0  | 0    | 0  | 0  | 0  | 0  | 1  | 0  | 1  |

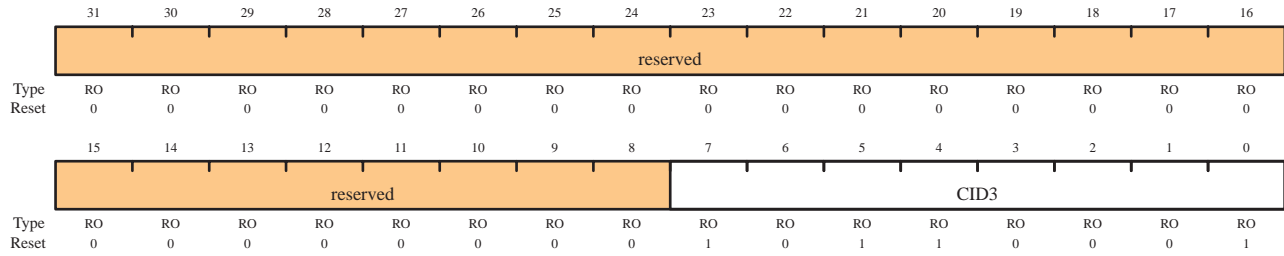
| Bit/Field | Name     | Type | Reset | Description   |
|-----------|----------|------|-------|---|
| 31:8      | reserved | RO   | 0     | Reserved bits return an indeterminate value, and should never be changed.                                 |
| 7:0       | CID2     | RO   | 0x05  | UART PrimeCell ID Register[23:16]<br>Provides software a standard cross-peripheral identification system. |

**Register 24: UART PrimeCell Identification 3 (UARTPCelIID3), offset 0xFFC**

The **UARTPCelIIDn** registers are hard-coded and the fields within the registers determine the reset values.

UART Primecell Identification 3 (UARTPCelIID3)

Offset 0xFFC



| Bit/Field | Name     | Type | Reset | Description   |
|-----------|----------|------|-------|---|
| 31:8      | reserved | RO   | 0     | Reserved bits return an indeterminate value, and should never be changed.                                 |
| 7:0       | CID3     | RO   | 0xB1  | UART PrimeCell ID Register[31:24]<br>Provides software a standard cross-peripheral identification system. |

## 13 Synchronous Serial Interface (SSI)

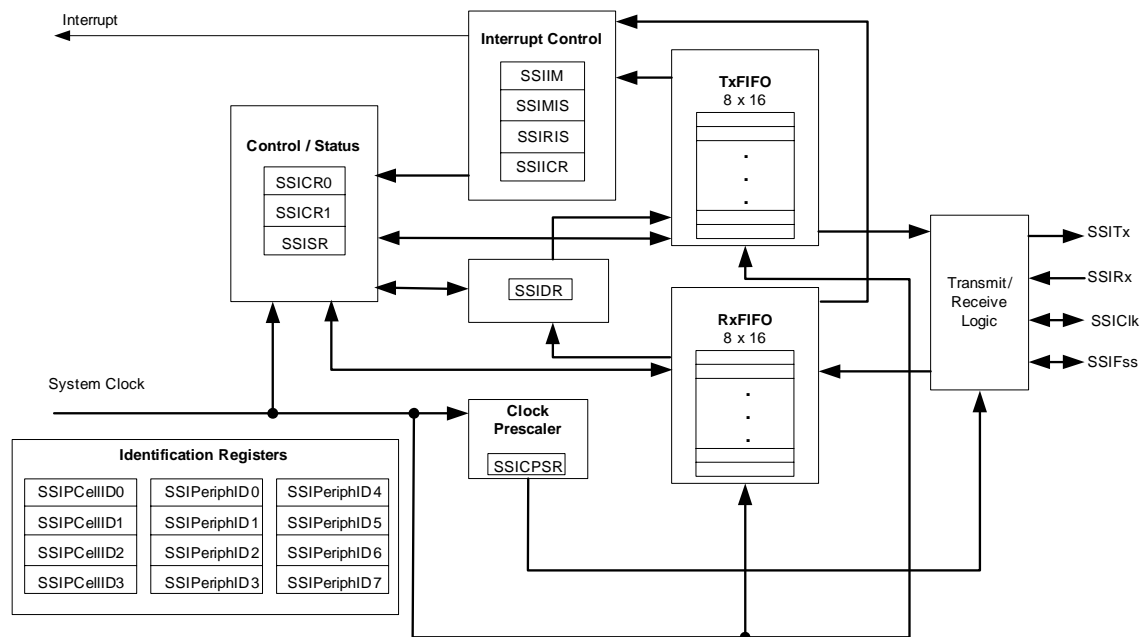
The Stellaris Synchronous Serial Interface (SSI) is a master or slave interface for synchronous serial communication with peripheral devices that have either Freescale SPI, MICROWIRE, or Texas Instruments synchronous serial interfaces.

The Stellaris SSI has the following features:

- Master or slave operation
- Programmable clock bit rate and prescale
- Separate transmit and receive FIFOs, 16 bits wide, 8 locations deep
- Programmable interface operation for Freescale SPI, MICROWIRE, or Texas Instruments synchronous serial interfaces
- Programmable data frame size from 4 to 16 bits
- Internal loopback test mode for diagnostic/debug testing

### 13.1 Block Diagram

Figure 13-1. SSI Module Block Diagram



## 13.2 Functional Description

The SSI performs serial-to-parallel conversion on data received from a peripheral device. The CPU accesses data, control, and status information. The transmit and receive paths are buffered with internal FIFO memories allowing up to eight 16-bit values to be stored independently in both transmit and receive modes.

### 13.2.1 Bit Rate Generation

The SSI includes a programmable bit rate clock divider and prescaler to generate the serial output clock. Bit rates are supported to 2 MHz and higher, although maximum bit rate is determined by peripheral devices.

The serial bit rate is derived by dividing down the 50-MHz input clock. The clock is first divided by an even prescale value `CPSDVSR` from 2 to 254, which is programmed in the **SSI Clock Prescale (SSICPSR)** register (see page 279). The clock is further divided by a value from 1 to 256, which is  $1 + SCR$ , where `SCR` is the value programmed in the **SSI Control0 (SSICR0)** register (see page 273).

The frequency of the output clock `SSIClk` is defined by:

$$f_{SSIClk} = f_{SysClk} / (CPSDVSR * (1 + SCR))$$

Note that although the `SSIClk` transmit clock can theoretically be 25 MHz, the module may not be able to operate at that speed. For transmit operations, the system clock must be at least two times faster than the `SSIClk`. For receive operations, the system clock must be at least 12 times faster than the `SSIClk`.

See “Electrical Characteristics” on page 338 to view SSI timing parameters.

### 13.2.2 FIFO Operation

#### 13.2.2.1 Transmit FIFO

The common transmit FIFO is a 16-bit wide, 8-locations deep, first-in, first-out memory buffer. The CPU writes data to the FIFO by writing the **SSI Data (SSIDR)** register (see page 277), and data is stored in the FIFO until it is read out by the transmission logic.

When configured as a master or a slave, parallel data is written into the transmit FIFO prior to serial conversion and transmission to the attached slave or master, respectively, through the `SSITx` pin.

#### 13.2.2.2 Receive FIFO

The common receive FIFO is a 16-bit wide, 8-locations deep, first-in, first-out memory buffer. Received data from the serial interface is stored in the buffer until read out by the CPU, which accesses the read FIFO by reading the **SSIDR** register.

When configured as a master or slave, serial data received through the `SSIRx` pin is registered prior to parallel loading into the attached slave or master receive FIFO, respectively.

### 13.2.3 Interrupts

The SSI can generate interrupts when the following conditions are observed:

- Transmit FIFO service
- Receive FIFO service
- Receive FIFO time-out
- Receive FIFO overrun

All of the interrupt events are ORed together before being sent to the interrupt controller, so the SSI can only generate a single interrupt request to the controller at any given time. You can mask each of the four individual maskable interrupts by setting the appropriate bits in the **SSI Interrupt Mask (SSIIM)** register (see page 280). Setting the appropriate mask bit to 1 enables the interrupt.

Provision of the individual outputs, as well as a combined interrupt output, allows use of either a global interrupt service routine, or modular device drivers to handle interrupts. The transmit and receive dynamic dataflow interrupts have been separated from the status interrupts so that data can be read or written in response to the FIFO trigger levels. The status of the individual interrupt sources can be read from the **SSI Raw Interrupt Status (SSIRIS)** and **SSI Masked Interrupt Status (SSIMIS)** registers (see page 281 and page 282, respectively).

### 13.2.4 Frame Formats

Each data frame is between 4 and 16 bits long, depending on the size of data programmed, and is transmitted starting with the MSB. There are three basic frame types that can be selected:

- Texas Instruments synchronous serial
- Freescale SPI
- MICROWIRE

For all three formats, the serial clock (SSIClk) is held inactive while the SSI is idle, and SSIClk transitions at the programmed frequency only during active transmission or reception of data. The idle state of SSIClk is utilized to provide a receive timeout indication that occurs when the receive FIFO still contains data after a timeout period.

For Freescale SPI and MICROWIRE frame formats, the serial frame (SSIFss) pin is active Low, and is asserted (pulled down) during the entire transmission of the frame.

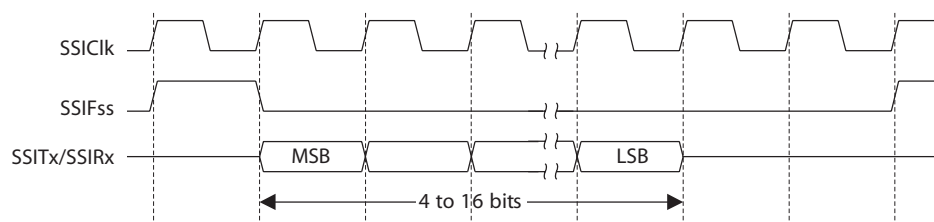
For Texas Instruments synchronous serial frame format, the SSIFss pin is pulsed for one serial clock period starting at its rising edge, prior to the transmission of each frame. For this frame format, both the SSI and the off-chip slave device drive their output data on the rising edge of SSIClk, and latch data from the other device on the falling edge.

Unlike the full-duplex transmission of the other two frame formats, the MICROWIRE format uses a special master-slave messaging technique, which operates at half-duplex. In this mode, when a frame begins, an 8-bit control message is transmitted to the off-chip slave. During this transmit, no incoming data is received by the SSI. After the message has been sent, the off-chip slave decodes it and, after waiting one serial clock after the last bit of the 8-bit control message has been sent, responds with the requested data. The returned data can be 4 to 16 bits in length, making the total frame length anywhere from 13 to 25 bits.

#### 13.2.4.1 Texas Instruments Synchronous Serial Frame Format

Figure 13-2 shows the Texas Instruments synchronous serial frame format for a single transmitted frame.

**Figure 13-2. TI Synchronous Serial Frame Format (Single Transfer)**

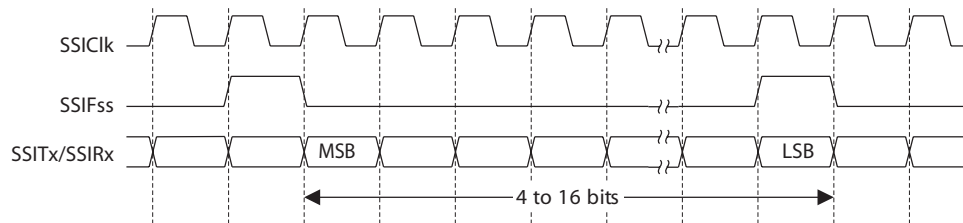


In this mode,  $SSIClk$  and  $SSIFss$  are forced Low, and the transmit data line  $SSITx$  is tristated whenever the SSI is idle. Once the bottom entry of the transmit FIFO contains data,  $SSIFss$  is pulsed High for one  $SSIClk$  period. The value to be transmitted is also transferred from the transmit FIFO to the serial shift register of the transmit logic. On the next rising edge of  $SSIClk$ , the MSB of the 4 to 16-bit data frame is shifted out on the  $SSITx$  pin. Likewise, the MSB of the received data is shifted onto the  $SSIRx$  pin by the off-chip serial slave device.

Both the SSI and the off-chip serial slave device then clock each data bit into their serial shifter on the falling edge of each  $SSIClk$ . The received data is transferred from the serial shifter to the receive FIFO on the first rising edge of  $SSIClk$  after the LSB has been latched.

Figure 13-3 shows the Texas Instruments synchronous serial frame format when back-to-back frames are transmitted.

**Figure 13-3. TI Synchronous Serial Frame Format (Continuous Transfer)**



#### 13.2.4.2 Freescale SPI Frame Format

The Freescale SPI interface is a four-wire interface where the  $SSIFss$  signal behaves as a slave select. The main feature of the Freescale SPI format is that the inactive state and phase of the  $SSIClk$  signal are programmable through the  $SPO$  and  $SPH$  bits within the **SSISCR0** control register.

##### **SPO Clock Polarity Bit**

When the  $SPO$  clock polarity control bit is Low, it produces a steady state Low value on the  $SSIClk$  pin. If the  $SPO$  bit is High, a steady state High value is placed on the  $SSIClk$  pin when data is not being transferred.

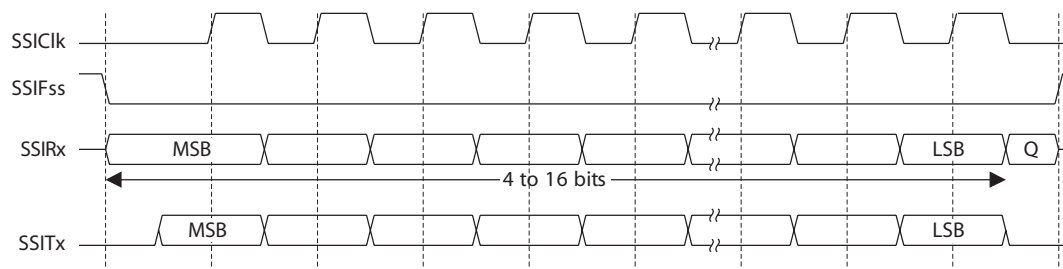
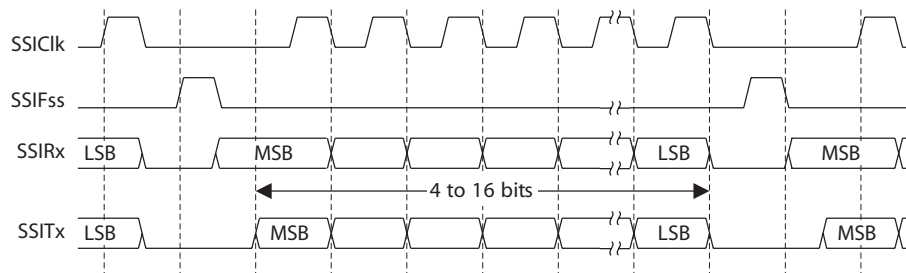
##### **SPH Phase Control Bit**

The  $SPH$  phase control bit selects the clock edge that captures data and allows it to change state. It has the most impact on the first bit transmitted by either allowing or not allowing a clock transition before the first data capture edge. When the  $SPH$  phase control bit is Low, data is captured on the first clock edge transition. If the  $SPH$  bit is High, data is captured on the second clock edge transition.

#### 13.2.4.3 Freescale SPI Frame Format with $SPO=0$ and $SPH=0$

Single and continuous transmission signal sequences for Freescale SPI format with  $SPO=0$  and  $SPH=0$  are shown in Figure 13-4 and Figure 13-5.



**Figure 13-4. Freescale SPI Format (Single Transfer) with SPO=0 and SPH=0****Figure 13-5. Freescale SPI Format (Continuous Transfer) with SPO=0 and SPH=0**

In this configuration, during idle periods:

- SSIClk is forced Low
- SSIFss is forced High
- The transmit data line SSITx is arbitrarily forced Low
- When the SSI is configured as a master, it enables the SSIClk pad
- When the SSI is configured as a slave, it disables the SSIClk pad

If the SSI is enabled and there is valid data within the transmit FIFO, the start of transmission is signified by the SSIFss master signal being driven Low. This causes slave data to be enabled onto the SSIRx input line of the master. The master SSITx output pad is enabled.

One half SSIClk period later, valid master data is transferred to the SSITx pin. Now that both the master and slave data have been set, the SSIClk master clock pin goes High after one further half SSIClk period.

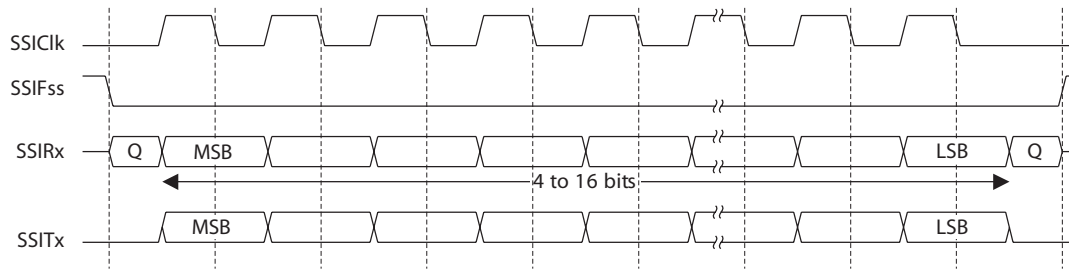
The data is now captured on the rising and propagated on the falling edges of the SSIClk signal.

In the case of a single word transmission, after all bits of the data word have been transferred, the SSIFss line is returned to its idle High state one SSIClk period after the last bit has been captured.

However, in the case of continuous back-to-back transmissions, the SSIFss signal must be pulsed High between each data word transfer. This is because the slave select pin freezes the data in its serial peripheral register and does not allow it to be altered if the SPH bit is logic zero. Therefore, the master device must raise the SSIFss pin of the slave device between each data transfer to enable the serial peripheral data write. On completion of the continuous transfer, the SSIFss pin is returned to its idle state one SSIClk period after the last bit has been captured.

#### 13.2.4.4 Freescale SPI Frame Format with SPO=0 and SPH=1

The transfer signal sequence for Freescale SPI format with SPO=0 and SPH=1 is shown in Figure 13-6, which covers both single and continuous transfers.

**Figure 13-6. Freescale SPI Frame Format with SPO=0 and SPH=1**

In this configuration, during idle periods:

- SSIClk is forced Low
- SSIFss is forced High
- The transmit data line SSITx is arbitrarily forced Low
- When the SSI is configured as a master, it enables the SSIClk pad
- When the SSI is configured as a slave, it disables the SSIClk pad

If the SSI is enabled and there is valid data within the transmit FIFO, the start of transmission is signified by the SSIFss master signal being driven Low. The master SSITx output is enabled. After a further one half SSIClk period, both master and slave valid data is enabled onto their respective transmission lines. At the same time, the SSIClk is enabled with a rising edge transition.

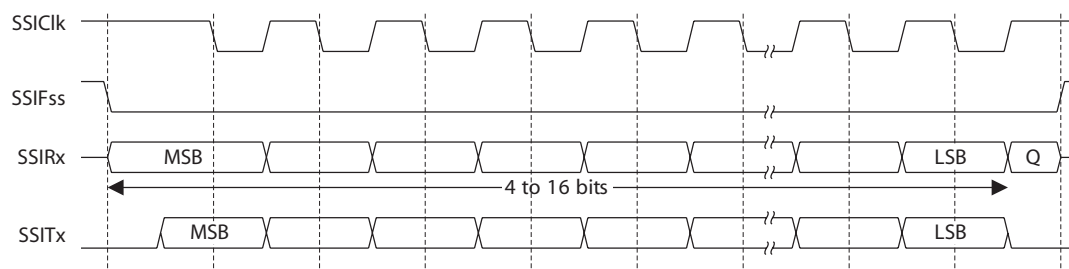
Data is then captured on the falling edges and propagated on the rising edges of the SSIClk signal.

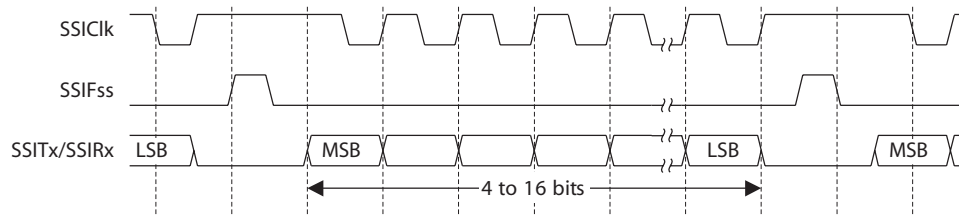
In the case of a single word transfer, after all bits have been transferred, the SSIFss line is returned to its idle High state one SSIClk period after the last bit has been captured.

For continuous back-to-back transfers, the SSIFss pin is held Low between successive data words and termination is the same as that of the single word transfer.

#### 13.2.4.5 Freescale SPI Frame Format with SPO=1 and SPH=0

Single and continuous transmission signal sequences for Freescale SPI format with SPO=1 and SPH=0 are shown in Figure 13-7 and Figure 13-8.

**Figure 13-7. Freescale SPI Frame Format (Single Transfer) with SPO=1 and SPH=0**

**Figure 13-8. Freescale SPI Frame Format (Continuous Transfer) with SPO=1 and SPH=0**

In this configuration, during idle periods:

- SSIClk is forced High
- SSIFss is forced High
- The transmit data line SSITx is arbitrarily forced Low
- When the SSI is configured as a master, it enables the SSIClk pad
- When the SSI is configured as a slave, it disables the SSIClk pad

If the SSI is enabled and there is valid data within the transmit FIFO, the start of transmission is signified by the SSIFss master signal being driven Low, which causes slave data to be immediately transferred onto the SSIRx line of the master. The master SSITx output pad is enabled.

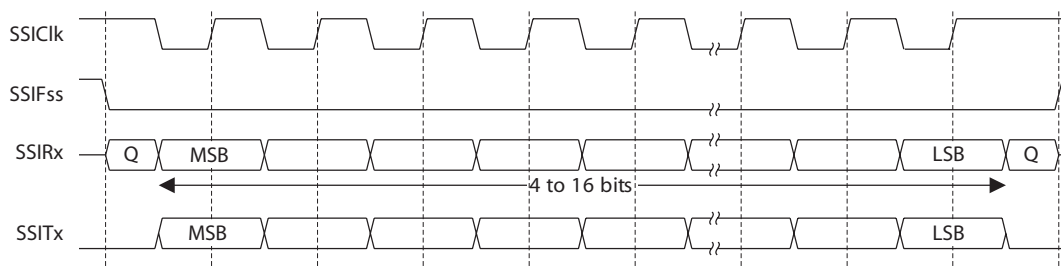
One half period later, valid master data is transferred to the SSITx line. Now that both the master and slave data have been set, the SSIClk master clock pin becomes Low after one further half SSIClk period. This means that data is captured on the falling edges and propagated on the rising edges of the SSIClk signal.

In the case of a single word transmission, after all bits of the data word are transferred, the SSIFss line is returned to its idle High state one SSIClk period after the last bit has been captured.

However, in the case of continuous back-to-back transmissions, the SSIFss signal must be pulsed High between each data word transfer. This is because the slave select pin freezes the data in its serial peripheral register and does not allow it to be altered if the SPH bit is logic zero. Therefore, the master device must raise the SSIFss pin of the slave device between each data transfer to enable the serial peripheral data write. On completion of the continuous transfer, the SSIFss pin is returned to its idle state one SSIClk period after the last bit has been captured.

#### 13.2.4.6 Freescale SPI Frame Format with SPO=1 and SPH=1

The transfer signal sequence for Freescale SPI format with SPO=1 and SPH=1 is shown in Figure 13-9, which covers both single and continuous transfers.

**Figure 13-9. Freescale SPI Frame Format with SPO=1 and SPH=1**

**Note:** Q is undefined in Figure 13-9.

In this configuration, during idle periods:

- SSIClk is forced High
- SSIFss is forced High
- The transmit data line SSITx is arbitrarily forced Low
- When the SSI is configured as a master, it enables the SSIClk pad
- When the SSI is configured as a slave, it disables the SSIClk pad

If the SSI is enabled and there is valid data within the transmit FIFO, the start of transmission is signified by the SSIFss master signal being driven Low. The master SSITx output pad is enabled. After a further one-half SSIClk period, both master and slave data are enabled onto their respective transmission lines. At the same time, SSIClk is enabled with a falling edge transition. Data is then captured on the rising edges and propagated on the falling edges of the SSIClk signal.

After all bits have been transferred, in the case of a single word transmission, the SSIFss line is returned to its idle high state one SSIClk period after the last bit has been captured.

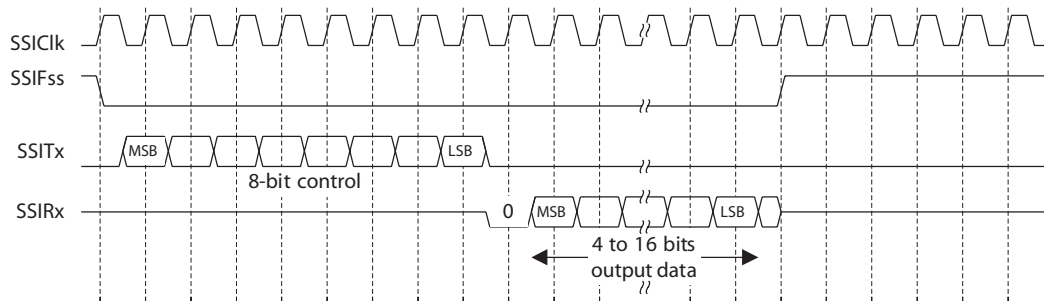
For continuous back-to-back transmissions, the SSIFss pin remains in its active Low state, until the final bit of the last word has been captured, and then returns to its idle state as described above.

For continuous back-to-back transfers, the SSIFss pin is held Low between successive data words and termination is the same as that of the single word transfer.

#### 13.2.4.7 MICROWIRE Frame Format

Figure 13-10 shows the MICROWIRE frame format, again for a single frame. Figure 13-11 shows the same format when back-to-back frames are transmitted.

**Figure 13-10. MICROWIRE Frame Format (Single Frame)**



MICROWIRE format is very similar to SPI format, except that transmission is half-duplex instead of full-duplex, using a master-slave message passing technique. Each serial transmission begins with an 8-bit control word that is transmitted from the SSI to the off-chip slave device. During this transmission, no incoming data is received by the SSI. After the message has been sent, the off-chip slave decodes it and, after waiting one serial clock after the last bit of the 8-bit control message has been sent, responds with the required data. The returned data is 4 to 16 bits in length, making the total frame length anywhere from 13 to 25 bits.

In this configuration, during idle periods:

- SSIClk is forced Low
- SSIFss is forced High
- The transmit data line SSITx is arbitrarily forced Low

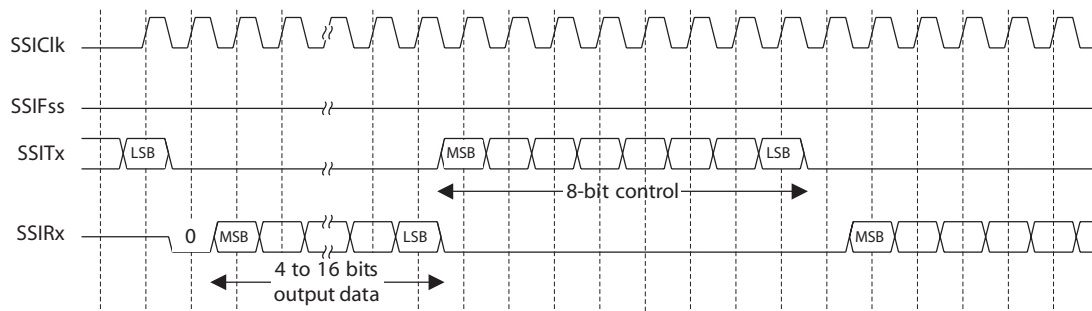
A transmission is triggered by writing a control byte to the transmit FIFO. The falling edge of  $SSIF_{SS}$  causes the value contained in the bottom entry of the transmit FIFO to be transferred to the serial shift register of the transmit logic, and the MSB of the 8-bit control frame to be shifted out onto the  $SSITx$  pin.  $SSIF_{SS}$  remains Low for the duration of the frame transmission. The  $SSIRx$  pin remains tristated during this transmission.

The off-chip serial slave device latches each control bit into its serial shifter on the rising edge of each  $SSIClk$ . After the last bit is latched by the slave device, the control byte is decoded during a one clock wait-state, and the slave responds by transmitting data back to the SSI. Each bit is driven onto the  $SSIRx$  line on the falling edge of  $SSIClk$ . The SSI in turn latches each bit on the rising edge of  $SSIClk$ . At the end of the frame, for single transfers, the  $SSIF_{SS}$  signal is pulled High one clock period after the last bit has been latched in the receive serial shifter, which causes the data to be transferred to the receive FIFO.

**Note:** The off-chip slave device can tristate the receive line either on the falling edge of  $SSIClk$  after the LSB has been latched by the receive shifter, or when the  $SSIF_{SS}$  pin goes High.

For continuous transfers, data transmission begins and ends in the same manner as a single transfer. However, the  $SSIF_{SS}$  line is continuously asserted (held Low) and transmission of data occurs back-to-back. The control byte of the next frame follows directly after the LSB of the received data from the current frame. Each of the received values is transferred from the receive shifter on the falling edge of  $SSIClk$ , after the LSB of the frame has been latched into the SSI.

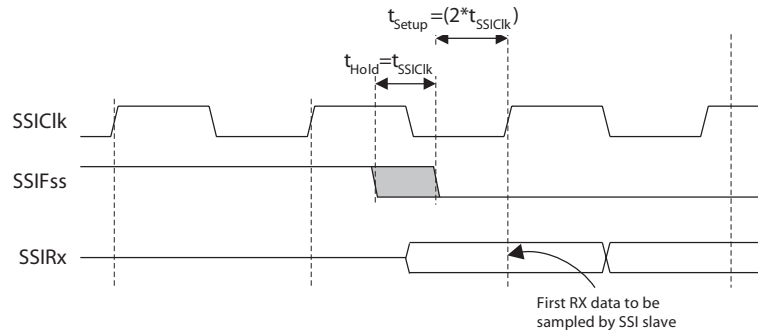
**Figure 13-11. MICROWIRE Frame Format (Continuous Transfer)**



In the MICROWIRE mode, the SSI slave samples the first bit of receive data on the rising edge of  $SSIClk$  after  $SSIF_{SS}$  has gone Low. Masters that drive a free-running  $SSIClk$  must ensure that the  $SSIF_{SS}$  signal has sufficient setup and hold margins with respect to the rising edge of  $SSIClk$ .

Figure 13-12 illustrates these setup and hold time requirements. With respect to the  $SSIClk$  rising edge on which the first bit of receive data is to be sampled by the SSI slave,  $SSIF_{SS}$  must have a setup of at least two times the period of  $SSIClk$  on which the SSI operates. With respect to the  $SSIClk$  rising edge previous to this edge,  $SSIF_{SS}$  must have a hold of at least one  $SSIClk$  period.

Figure 13-12. MICROWIRE Frame Format, SSIFss Input Setup and Hold Requirements



### 13.3 Initialization and Configuration

To use the SSI, its peripheral clock must be enabled by setting the **SSI** bit in the **RCGC1** register.

For each of the frame formats, the SSI is configured using the following steps:

1. Ensure that the **SSE** bit in the **SSICR1** register is disabled before making any configuration changes.
2. Select whether the SSI is a master or slave:
  - a. For master operations, set the **SSICR1** register to 0x00000000.
  - b. For slave mode (output enabled), set the **SSICR1** register to 0x00000004.
  - c. For slave mode (output disabled), set the **SSICR1** register to 0x0000000C.
3. Configure the clock prescale divisor by writing the **SSICPSR** register.
4. Write the **SSICR0** register with the following configuration:
  - Serial clock rate (**SCR**)
  - Desired clock phase/polarity, if using Freescale SPI mode (**SPH** and **SPO**)
  - The protocol mode: Freescale SPI, TI SSF, MICROWIRE (**FRF**)
  - The data size (**DSS**)
5. Enable the SSI by setting the **SSE** bit in the **SSICR1** register.

As an example, assume the SSI must be configured to operate with the following parameters:

- Master operation
- Freescale SPI mode (**SPO**=1, **SPH**=1)
- 1 Mbps bit rate
- 8 data bits

Assuming the system clock is 20 MHz, the bit rate calculation would be:

$$F_{SSIClk} = F_{SysClk} / (CPSDVSR * (1 + SCR)) * 1x10^6 = 20x10^6 / (CPSDVSR * (1 + SCR))$$

In this case, if **CPSDVSR**=2, **SCR** must be 9.

The configuration sequence would be as follows:

1. Ensure that the **SSE** bit in the **SSICR1** register is disabled.
2. Write the **SSICR1** register with a value of 0x00000000.

3. Write the **SSICPSR** register with a value of 0x00000002.
4. Write the **SSICR0** register with a value of 0x000009C7.
5. The SSI is then enabled by setting the *SSE* bit in the **SSICR1** register to 1.

## 13.4 Register Map

Table 13-1 lists the SSI registers. The offset listed is a hexadecimal increment to the register's address, relative to the SSI base address of 0x40008000.

**Note:** The SSI must be disabled (see the *SSE* bit in the **SSICR1** register) before any of the control registers are reprogrammed.

**Table 13-1. SSI Register Map**

| Offset | Name         | Reset      | Type | Description                 | See page |
|--------|--------------|------------|------|-----------------------------|----------|
| 0x000  | SSICR0       | 0x00000000 | RW   | Control 0                   | 273      |
| 0x004  | SSICR1       | 0x00000000 | RW   | Control 1                   | 275      |
| 0x008  | SSIDR        | 0x00000000 | RW   | Data                        | 277      |
| 0x00C  | SSISR        | 0x00000003 | RO   | Status                      | 278      |
| 0x010  | SSICPSR      | 0x00000000 | RW   | Clock prescale              | 279      |
| 0x014  | SSIIM        | 0x00000000 | RW   | Interrupt mask              | 280      |
| 0x018  | SSIRIS       | 0x00000008 | RO   | Raw interrupt status        | 281      |
| 0x01C  | SSIMIS       | 0x00000000 | RO   | Masked interrupt status     | 282      |
| 0x020  | SSIICR       | 0x00000000 | W1C  | Interrupt clear             | 283      |
| 0xFD0  | SSIPeriphID4 | 0x00000000 | RO   | Peripheral identification 4 | 284      |
| 0xFD4  | SSIPeriphID5 | 0x00000000 | RO   | Peripheral identification 5 | 285      |
| 0xFD8  | SSIPeriphID6 | 0x00000000 | RO   | Peripheral identification 6 | 286      |
| 0xFDC  | SSIPeriphID7 | 0x00000000 | RO   | Peripheral identification 7 | 287      |
| 0xFE0  | SSIPeriphID0 | 0x00000022 | RO   | Peripheral identification 0 | 288      |
| 0xFE4  | SSIPeriphID1 | 0x00000000 | RO   | Peripheral identification 1 | 289      |
| 0xFE8  | SSIPeriphID2 | 0x00000018 | RO   | Peripheral identification 2 | 290      |
| 0xFEC  | SSIPeriphID3 | 0x00000001 | RO   | Peripheral identification 3 | 291      |
| 0xFF0  | SSIPCellID0  | 0x0000000D | RO   | PrimeCell identification 0  | 292      |
| 0xFF4  | SSIPCellID1  | 0x000000F0 | RO   | PrimeCell identification 1  | 293      |
| 0xFF8  | SSIPCellID2  | 0x00000005 | RO   | PrimeCell identification 2  | 294      |
| 0xFFC  | SSIPCellID3  | 0x000000B1 | RO   | PrimeCell identification 3  | 295      |

## **13.5 Register Descriptions**

The remainder of this section lists and describes the SSI registers, in numerical order by address offset.



**Register 1: SSI Control 0 (SSICR0), offset 0x000**

**SSICR0** is control register 0 and contains bit fields that control various functions within the SSI module. Functionality such as protocol mode, clock rate and data size are configured in this register.

## SSI Control 0 (SSICR0)

Offset 0x000

|       |          |     |     |     |     |     |     |     |     |     |     |     |     |     |     |     |
|-------|----------|-----|-----|-----|-----|-----|-----|-----|-----|-----|-----|-----|-----|-----|-----|-----|
|       | 31       | 30  | 29  | 28  | 27  | 26  | 25  | 24  | 23  | 22  | 21  | 20  | 19  | 18  | 17  | 16  |
|       | reserved |     |     |     |     |     |     |     |     |     |     |     |     |     |     |     |
| Type  | RO       | RO  | RO  | RO  | RO  | RO  | RO  | RO  | RO  | RO  | RO  | RO  | RO  | RO  | RO  | RO  |
| Reset | 0        | 0   | 0   | 0   | 0   | 0   | 0   | 0   | 0   | 0   | 0   | 0   | 0   | 0   | 0   | 0   |
|       | 15       | 14  | 13  | 12  | 11  | 10  | 9   | 8   | 7   | 6   | 5   | 4   | 3   | 2   | 1   | 0   |
|       | SCR      |     |     |     |     |     |     |     | SPH | SPO | FRF |     | DSS |     |     |     |
| Type  | R/W      | R/W | R/W | R/W | R/W | R/W | R/W | R/W | R/W | R/W | R/W | R/W | R/W | R/W | R/W | R/W |
| Reset | 0        | 0   | 0   | 0   | 0   | 0   | 0   | 0   | 0   | 0   | 0   | 0   | 0   | 0   | 0   | 0   |

| Bit/Field | Name     | Type | Reset | Description   |
|-----------|----------|------|-------|---|
| 31:16     | reserved | RO   | 0     | Reserved bits return an indeterminate value, and should never be changed.   |
| 15:8      | SCR      | R/W  | 0     | SSI Serial Clock Rate<br><br>The value <i>SCR</i> is used to generate the transmit and receive bit rate of the SSI. The bit rate is:<br>$BR = F_{SSICLK} / (CPSDVSR * (1 + SCR))$ where <i>CPSDVSR</i> is an even value from 2-254 programmed in the <b>SSICPSR</b> register, and <i>SCR</i> is a value from 0-255.   |
| 7         | SPH      | R/W  | 0     | SSI Serial Clock Phase<br><br>This bit is only applicable to the Freescale SPI Format.<br><br>The <i>SPH</i> control bit selects the clock edge that captures data and allows it to change state. It has the most impact on the first bit transmitted by either allowing or not allowing a clock transition before the first data capture edge.<br><br>When the <i>SPH</i> bit is 0, data is captured on the first clock edge transition. If <i>SPH</i> is 1, data is captured on the second clock edge transition. |
| 6         | SPO      | R/W  | 0     | SSI Serial Clock Polarity<br><br>This bit is only applicable to the Freescale SPI Format.<br><br>When the <i>SPO</i> bit is 0, it produces a steady state Low value on the <i>SSICLK</i> pin. If <i>SPO</i> is 1, a steady state High value is placed on the <i>SSICLK</i> pin when data is not being transferred.  |

## Synchronous Serial Interface (SSI)

---

| Bit/Field | Name  | Type | Reset | Description  |           |              |           |                            |      |   |      |                        |      |            |      |            |      |            |      |            |      |             |      |             |      |             |      |             |      |             |      |             |      |             |
|-----------|---|------|-------|--|-----------|--------------|-----------|----------------------------|------|---|------|------------------------|------|------------|------|------------|------|------------|------|------------|------|-------------|------|-------------|------|-------------|------|-------------|------|-------------|------|-------------|------|-------------|
| 5:4       | FRF   | R/W  | 0     | SSI Frame Format Select.<br>The FRF values are defined as follows:<br><table><thead><tr><th>FRF Value</th><th>Frame Format</th></tr></thead><tbody><tr><td>00</td><td>Freescale SPI Frame Format</td></tr><tr><td>01</td><td>Texas Instruments Synchronous Serial Frame Format</td></tr><tr><td>10</td><td>MICROWIRE Frame Format</td></tr><tr><td>11</td><td>Reserved</td></tr></tbody></table>   | FRF Value | Frame Format | 00        | Freescale SPI Frame Format | 01   | Texas Instruments Synchronous Serial Frame Format | 10   | MICROWIRE Frame Format | 11   | Reserved   |      |            |      |            |      |            |      |             |      |             |      |             |      |             |      |             |      |             |      |             |
| FRF Value | Frame Format                                      |      |       |  |           |              |           |                            |      |   |      |                        |      |            |      |            |      |            |      |            |      |             |      |             |      |             |      |             |      |             |      |             |      |             |
| 00        | Freescale SPI Frame Format                        |      |       |  |           |              |           |                            |      |   |      |                        |      |            |      |            |      |            |      |            |      |             |      |             |      |             |      |             |      |             |      |             |      |             |
| 01        | Texas Instruments Synchronous Serial Frame Format |      |       |  |           |              |           |                            |      |   |      |                        |      |            |      |            |      |            |      |            |      |             |      |             |      |             |      |             |      |             |      |             |      |             |
| 10        | MICROWIRE Frame Format                            |      |       |  |           |              |           |                            |      |   |      |                        |      |            |      |            |      |            |      |            |      |             |      |             |      |             |      |             |      |             |      |             |      |             |
| 11        | Reserved  |      |       |  |           |              |           |                            |      |   |      |                        |      |            |      |            |      |            |      |            |      |             |      |             |      |             |      |             |      |             |      |             |      |             |
| 3:0       | DSS   | R/W  | 0     | SSI Data Size Select<br>The DSS values are defined as follows:<br><table><thead><tr><th>DSS Value</th><th>Data Size</th></tr></thead><tbody><tr><td>0000-0010</td><td>Reserved</td></tr><tr><td>0011</td><td>4-bit data</td></tr><tr><td>0100</td><td>5-bit data</td></tr><tr><td>0101</td><td>6-bit data</td></tr><tr><td>0110</td><td>7-bit data</td></tr><tr><td>0111</td><td>8-bit data</td></tr><tr><td>1000</td><td>9-bit data</td></tr><tr><td>1001</td><td>10-bit data</td></tr><tr><td>1010</td><td>11-bit data</td></tr><tr><td>1011</td><td>12-bit data</td></tr><tr><td>1100</td><td>13-bit data</td></tr><tr><td>1101</td><td>14-bit data</td></tr><tr><td>1110</td><td>15-bit data</td></tr><tr><td>1111</td><td>16-bit data</td></tr></tbody></table> | DSS Value | Data Size    | 0000-0010 | Reserved                   | 0011 | 4-bit data  | 0100 | 5-bit data             | 0101 | 6-bit data | 0110 | 7-bit data | 0111 | 8-bit data | 1000 | 9-bit data | 1001 | 10-bit data | 1010 | 11-bit data | 1011 | 12-bit data | 1100 | 13-bit data | 1101 | 14-bit data | 1110 | 15-bit data | 1111 | 16-bit data |
| DSS Value | Data Size   |      |       |  |           |              |           |                            |      |   |      |                        |      |            |      |            |      |            |      |            |      |             |      |             |      |             |      |             |      |             |      |             |      |             |
| 0000-0010 | Reserved  |      |       |  |           |              |           |                            |      |   |      |                        |      |            |      |            |      |            |      |            |      |             |      |             |      |             |      |             |      |             |      |             |      |             |
| 0011      | 4-bit data  |      |       |  |           |              |           |                            |      |   |      |                        |      |            |      |            |      |            |      |            |      |             |      |             |      |             |      |             |      |             |      |             |      |             |
| 0100      | 5-bit data  |      |       |  |           |              |           |                            |      |   |      |                        |      |            |      |            |      |            |      |            |      |             |      |             |      |             |      |             |      |             |      |             |      |             |
| 0101      | 6-bit data  |      |       |  |           |              |           |                            |      |   |      |                        |      |            |      |            |      |            |      |            |      |             |      |             |      |             |      |             |      |             |      |             |      |             |
| 0110      | 7-bit data  |      |       |  |           |              |           |                            |      |   |      |                        |      |            |      |            |      |            |      |            |      |             |      |             |      |             |      |             |      |             |      |             |      |             |
| 0111      | 8-bit data  |      |       |  |           |              |           |                            |      |   |      |                        |      |            |      |            |      |            |      |            |      |             |      |             |      |             |      |             |      |             |      |             |      |             |
| 1000      | 9-bit data  |      |       |  |           |              |           |                            |      |   |      |                        |      |            |      |            |      |            |      |            |      |             |      |             |      |             |      |             |      |             |      |             |      |             |
| 1001      | 10-bit data                                       |      |       |  |           |              |           |                            |      |   |      |                        |      |            |      |            |      |            |      |            |      |             |      |             |      |             |      |             |      |             |      |             |      |             |
| 1010      | 11-bit data                                       |      |       |  |           |              |           |                            |      |   |      |                        |      |            |      |            |      |            |      |            |      |             |      |             |      |             |      |             |      |             |      |             |      |             |
| 1011      | 12-bit data                                       |      |       |  |           |              |           |                            |      |   |      |                        |      |            |      |            |      |            |      |            |      |             |      |             |      |             |      |             |      |             |      |             |      |             |
| 1100      | 13-bit data                                       |      |       |  |           |              |           |                            |      |   |      |                        |      |            |      |            |      |            |      |            |      |             |      |             |      |             |      |             |      |             |      |             |      |             |
| 1101      | 14-bit data                                       |      |       |  |           |              |           |                            |      |   |      |                        |      |            |      |            |      |            |      |            |      |             |      |             |      |             |      |             |      |             |      |             |      |             |
| 1110      | 15-bit data                                       |      |       |  |           |              |           |                            |      |   |      |                        |      |            |      |            |      |            |      |            |      |             |      |             |      |             |      |             |      |             |      |             |      |             |
| 1111      | 16-bit data                                       |      |       |  |           |              |           |                            |      |   |      |                        |      |            |      |            |      |            |      |            |      |             |      |             |      |             |      |             |      |             |      |             |      |             |

**Register 2: SSI Control 1 (SSICR1), offset 0x004**

**SSICR1** is control register 1 and contains bit fields that control various functions within the SSI module. Master and slave mode functionality is controlled by this register.

## SSI Control 1 (SSICR1)

Offset 0x004

|       |          |    |    |    |    |    |    |    |    |    |    |    |     |     |     |     |
|-------|----------|----|----|----|----|----|----|----|----|----|----|----|-----|-----|-----|-----|
|       | 31       | 30 | 29 | 28 | 27 | 26 | 25 | 24 | 23 | 22 | 21 | 20 | 19  | 18  | 17  | 16  |
|       | reserved |    |    |    |    |    |    |    |    |    |    |    |     |     |     |     |
| Type  | RO       | RO | RO | RO | RO | RO | RO | RO | RO | RO | RO | RO | RO  | RO  | RO  | RO  |
| Reset | 0        | 0  | 0  | 0  | 0  | 0  | 0  | 0  | 0  | 0  | 0  | 0  | 0   | 0   | 0   | 0   |
|       | 15       | 14 | 13 | 12 | 11 | 10 | 9  | 8  | 7  | 6  | 5  | 4  | 3   | 2   | 1   | 0   |
|       | reserved |    |    |    |    |    |    |    |    |    |    |    | SOD | MS  | SSE | LBM |
| Type  | RO       | RO | RO | RO | RO | RO | RO | RO | RO | RO | RO | RO | R/W | R/W | R/W | R/W |
| Reset | 0        | 0  | 0  | 0  | 0  | 0  | 0  | 0  | 0  | 0  | 0  | 0  | 0   | 0   | 0   | 0   |

| Bit/Field | Name     | Type | Reset | Description  |
|-----------|----------|------|-------|--|
| 31:4      | reserved | RO   | 0     | Reserved bits return an indeterminate value, and should never be changed.  |
| 3         | SOD      | R/W  | 0     | <p>SSI Slave Mode Output Disable</p> <p>This bit is relevant only in the Slave mode (<math>MS=1</math>). In multiple-slave systems, it is possible for the SSI master to broadcast a message to all slaves in the system while ensuring that only one slave drives data onto the serial output line. In such systems, the TXD lines from multiple slaves could be tied together. To operate in such a system, the SOD bit can be configured so that the SSI slave does not drive the SSITx pin.</p> <p>0: SSI can drive SSITx output in Slave Output mode.<br/>1: SSI must not drive the SSITx output in Slave mode.</p> |
| 2         | MS       | R/W  | 0     | <p>SSI Master/Slave Select</p> <p>This bit selects Master or Slave mode and can be modified only when SSI is disabled (<math>SSE=0</math>).</p> <p>0: Device configured as a master.<br/>1: Device configured as a slave.</p>  |

## Synchronous Serial Interface (SSI)

---

| Bit/Field | Name | Type | Reset | Description   |
|-----------|------|------|-------|---|
| 1         | SSE  | R/W  | 0     | SSI Synchronous Serial Port Enable<br>Setting this bit enables SSI operation.<br>0: SSI operation disabled.<br>1: SSI operation enabled.<br><b>Note:</b> This bit must be set to 0 before any control registers are reprogrammed.           |
| 0         | LBM  | R/W  | 0     | SSI Loopback Mode<br>Setting this bit enables Loopback Test mode.<br>0: Normal serial port operation enabled.<br>1: Output of the transmit serial shift register is connected internally to the input of the receive serial shift register. |

**Register 3: SSI Data (SSIDR), offset 0x008**

**SSIDR** is the data register and is 16-bits wide. When **SSIDR** is read, the entry in the receive FIFO (pointed to by the current FIFO read pointer) is accessed. As data values are removed by the SSI receive logic from the incoming data frame, they are placed into the entry in the receive FIFO (pointed to by the current FIFO write pointer).

When **SSIDR** is written to, the entry in the transmit FIFO (pointed to by the write pointer) is written to. Data values are removed from the transmit FIFO one value at a time by the transmit logic. It is loaded into the transmit serial shifter, then serially shifted out onto the **SSITx** pin at the programmed bit rate.

When a data size of less than 16 bits is selected, the user must right-justify data written to the transmit FIFO. The transmit logic ignores the unused bits. Received data less than 16 bits is automatically right-justified in the receive buffer.

When the SSI is programmed for MICROWIRE frame format, the default size for transmit data is eight bits (the most significant byte is ignored). The receive data size is controlled by the programmer. The transmit FIFO and the receive FIFO are not cleared even when the **SSE** bit in the **SSICR1** register is set to zero. This allows the software to fill the transmit FIFO before enabling the SSI.

## SSI Data (SSIDR)

Offset 0x008

|       | 31       | 30  | 29  | 28  | 27  | 26  | 25  | 24  | 23  | 22  | 21  | 20  | 19  | 18  | 17  | 16  |
|-------|----------|-----|-----|-----|-----|-----|-----|-----|-----|-----|-----|-----|-----|-----|-----|-----|
|       | reserved |     |     |     |     |     |     |     |     |     |     |     |     |     |     |     |
| Type  | RO       | RO  | RO  | RO  | RO  | RO  | RO  | RO  | RO  | RO  | RO  | RO  | RO  | RO  | RO  | RO  |
| Reset | 0        | 0   | 0   | 0   | 0   | 0   | 0   | 0   | 0   | 0   | 0   | 0   | 0   | 0   | 0   | 0   |
|       | 15       | 14  | 13  | 12  | 11  | 10  | 9   | 8   | 7   | 6   | 5   | 4   | 3   | 2   | 1   | 0   |
|       | DATA     |     |     |     |     |     |     |     |     |     |     |     |     |     |     |     |
| Type  | R/W      | R/W | R/W | R/W | R/W | R/W | R/W | R/W | R/W | R/W | R/W | R/W | R/W | R/W | R/W | R/W |
| Reset | 0        | 0   | 0   | 0   | 0   | 0   | 0   | 0   | 0   | 0   | 0   | 0   | 0   | 0   | 0   | 0   |

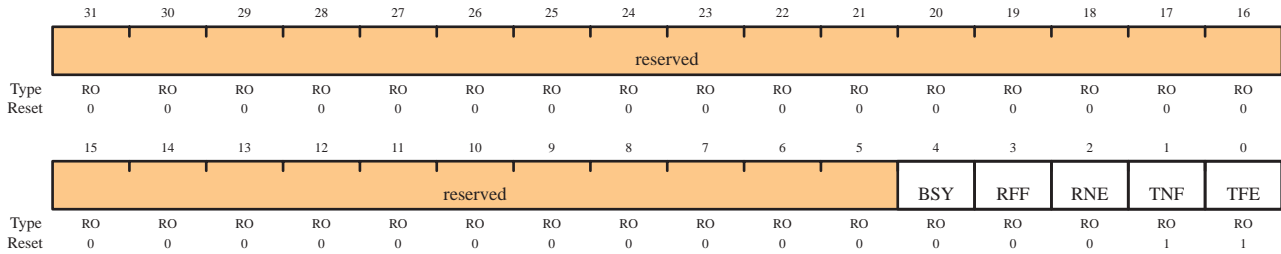
| Bit/Field | Name     | Type | Reset | Description   |
|-----------|----------|------|-------|---|
| 31:16     | reserved | RO   | 0     | Reserved bits return an indeterminate value, and should never be changed.   |
| 15:0      | DATA     | R/W  | 0     | SSI Receive/Transmit Data<br>A read operation reads the receive FIFO. A write operation writes the transmit FIFO.<br>Software must right-justify data when the SSI is programmed for a data size that is less than 16 bits. Unused bits at the top are ignored by the transmit logic. The receive logic automatically right-justifies the data. |

**Register 4: SSI Status (SSISR), offset 0x00C**

**SSISR** is a status register that contains bits that indicate the FIFO fill status and the SSI busy status.

SSI Status (SSISR)

Offset 0x00C



| Bit/Field | Name     | Type | Reset | Description  |
|-----------|----------|------|-------|--|
| 31:5      | reserved | RO   | 0     | Reserved bits return an indeterminate value, and should never be changed.  |
| 4         | BSY      | RO   | 0     | SSI Busy Bit<br>0: SSI is idle.<br>1: SSI is currently transmitting and/or receiving a frame, or the transmit FIFO is not empty. |
| 3         | RFF      | RO   | 0     | SSI Receive FIFO Full<br>0: Receive FIFO is not full.<br>1: Receive FIFO is full.  |
| 2         | RNE      | RO   | 0     | SSI Receive FIFO Not Empty<br>0: Receive FIFO is empty.<br>1: Receive FIFO is not empty.   |
| 1         | TNF      | RO   | 1     | SSI Transmit FIFO Not Full<br>0: Transmit FIFO is full.<br>1: Transmit FIFO is not full.   |
| 0         | TFE      | RO   | 1     | SSI Transmit FIFO Empty<br>0: Transmit FIFO is not empty.<br>1: Transmit FIFO is empty.  |

**Register 5: SSI Clock Prescale (SSICPSR), offset 0x010**

**SSICPSR** is the clock prescale register and specifies the division factor by which the system clock must be internally divided before further use.

The value programmed into this register must be an even number between 2 and 254. The least-significant bit of the programmed number is hard-coded to zero. If an odd number is written to this register, data read back from this register has the least-significant bit as zero.

## SSI Clock Prescale (SSICPSR)

Offset 0x010

|       |          |    |    |    |    |    |    |    |         |     |     |     |     |     |     |     |
|-------|----------|----|----|----|----|----|----|----|---------|-----|-----|-----|-----|-----|-----|-----|
|       | 31       | 30 | 29 | 28 | 27 | 26 | 25 | 24 | 23      | 22  | 21  | 20  | 19  | 18  | 17  | 16  |
|       | reserved |    |    |    |    |    |    |    |         |     |     |     |     |     |     |     |
| Type  | RO       | RO | RO | RO | RO | RO | RO | RO | RO      | RO  | RO  | RO  | RO  | RO  | RO  | RO  |
| Reset | 0        | 0  | 0  | 0  | 0  | 0  | 0  | 0  | 0       | 0   | 0   | 0   | 0   | 0   | 0   | 0   |
|       | 15       | 14 | 13 | 12 | 11 | 10 | 9  | 8  | 7       | 6   | 5   | 4   | 3   | 2   | 1   | 0   |
|       | reserved |    |    |    |    |    |    |    | CPSDVSR |     |     |     |     |     |     |     |
| Type  | RO       | RO | RO | RO | RO | RO | RO | RO | R/W     | R/W | R/W | R/W | R/W | R/W | R/W | R/W |
| Reset | 0        | 0  | 0  | 0  | 0  | 0  | 0  | 0  | 0       | 0   | 0   | 0   | 0   | 0   | 0   | 0   |

| Bit/Field | Name     | Type | Reset | Description   |
|-----------|----------|------|-------|---|
| 31:8      | reserved | RO   | 0     | Reserved bits return an indeterminate value, and should never be changed.   |
| 7:0       | CPSDVSR  | R/W  | 0     | SSI Clock Prescale Divisor<br>This value must be an even number from 2 to 254, depending on the frequency of <code>SSIClk</code> . The LSB always returns 0 on reads. |

**Register 6: SSI Interrupt Mask (SSIIM), offset 0x014**

The **SSIIM** register is the interrupt mask set or clear register. It is a read/write register and all bits are cleared to 0 on reset.

On a read, this register gives the current value of the mask on the relevant interrupt. A write of 1 to the particular bit sets the mask, enabling the interrupt to be read. A write of 0 clears the corresponding mask.

SSI Interrupt Mask (SSIIM)

Offset 0x014

|       |          |    |    |    |    |    |    |    |    |    |    |    |    |      |      |      |       |
|-------|----------|----|----|----|----|----|----|----|----|----|----|----|----|------|------|------|-------|
|       | 31       | 30 | 29 | 28 | 27 | 26 | 25 | 24 | 23 | 22 | 21 | 20 | 19 | 18   | 17   | 16   |       |
|       | reserved |    |    |    |    |    |    |    |    |    |    |    |    |      |      |      |       |
| Type  | RO       | RO | RO | RO | RO | RO | RO | RO | RO | RO | RO | RO | RO | RO   | RO   | RO   |       |
| Reset | 0        | 0  | 0  | 0  | 0  | 0  | 0  | 0  | 0  | 0  | 0  | 0  | 0  | 0    | 0    | 0    |       |
|       | 15       | 14 | 13 | 12 | 11 | 10 | 9  | 8  | 7  | 6  | 5  | 4  | 3  | 2    | 1    | 0    |       |
|       | reserved |    |    |    |    |    |    |    |    |    |    |    |    | TXIM | RXIM | RTIM | RORIM |
| Type  | RO       | RO | RO | RO | RO | RO | RO | RO | RO | RO | RO | RO | RO | R/W  | R/W  | R/W  | R/W   |
| Reset | 0        | 0  | 0  | 0  | 0  | 0  | 0  | 0  | 0  | 0  | 0  | 0  | 0  | 0    | 0    | 0    | 0     |

| Bit/Field | Name     | Type | Reset | Description  |
|-----------|----------|------|-------|--|
| 31:4      | reserved | RO   | 0     | Reserved bits return an indeterminate value, and should never be changed.  |
| 3         | TXIM     | R/W  | 0     | SSI Transmit FIFO Interrupt Mask<br>0: TX FIFO half-full or less condition interrupt is masked.<br>1: TX FIFO half-full or less condition interrupt is not masked. |
| 2         | RXIM     | R/W  | 0     | SSI Receive FIFO Interrupt Mask<br>0: RX FIFO half-full or more condition interrupt is masked.<br>1: RX FIFO half-full or more condition interrupt is not masked.  |
| 1         | RTIM     | R/W  | 0     | SSI Receive Time-Out Interrupt Mask<br>0: RX FIFO time-out interrupt is masked.<br>1: RX FIFO time-out interrupt is not masked.                                    |
| 0         | RORIM    | R/W  | 0     | SSI Receive Overrun Interrupt Mask<br>0: RX FIFO overrun interrupt is masked.<br>1: RX FIFO overrun interrupt is not masked.                                       |



**Register 7: SSI Raw Interrupt Status (SSIRIS), offset 0x018**

The **SSIRIS** register is the raw interrupt status register. On a read, this register gives the current raw status value of the corresponding interrupt prior to masking. A write has no effect.

## SSI Raw Interrupt Status (SSIRIS)

Offset 0x018

|       |          |    |    |    |    |    |    |    |    |    |    |    |       |       |       |        |
|-------|----------|----|----|----|----|----|----|----|----|----|----|----|-------|-------|-------|--------|
|       | 31       | 30 | 29 | 28 | 27 | 26 | 25 | 24 | 23 | 22 | 21 | 20 | 19    | 18    | 17    | 16     |
|       | reserved |    |    |    |    |    |    |    |    |    |    |    |       |       |       |        |
| Type  | RO       | RO | RO | RO | RO | RO | RO | RO | RO | RO | RO | RO | RO    | RO    | RO    | RO     |
| Reset | 0        | 0  | 0  | 0  | 0  | 0  | 0  | 0  | 0  | 0  | 0  | 0  | 0     | 0     | 0     | 0      |
|       | 15       | 14 | 13 | 12 | 11 | 10 | 9  | 8  | 7  | 6  | 5  | 4  | 3     | 2     | 1     | 0      |
|       | reserved |    |    |    |    |    |    |    |    |    |    |    | TXRIS | RXRIS | RTRIS | RORRIS |
| Type  | RO       | RO | RO | RO | RO | RO | RO | RO | RO | RO | RO | RO | RO    | RO    | RO    | RO     |
| Reset | 0        | 0  | 0  | 0  | 0  | 0  | 0  | 0  | 0  | 0  | 0  | 0  | 1     | 0     | 0     | 0      |

| Bit/Field | Name     | Type | Reset | Description  |
|-----------|----------|------|-------|--|
| 31:4      | reserved | RO   | 0     | Reserved bits return an indeterminate value, and should never be changed.                                  |
| 3         | TXRIS    | RO   | 1     | SSI Transmit FIFO Raw Interrupt Status<br>Indicates that the transmit FIFO is half full or less, when set. |
| 2         | RXRIS    | RO   | 0     | SSI Receive FIFO Raw Interrupt Status<br>Indicates that the receive FIFO is half full or more, when set.   |
| 1         | RTRIS    | RO   | 0     | SSI Receive Time-Out Raw Interrupt Status<br>Indicates that the receive time-out has occurred, when set.   |
| 0         | RORRIS   | RO   | 0     | SSI Receive Overflow Raw Interrupt Status<br>Indicates that the receive FIFO has overflowed, when set.     |

**Register 8: SSI Masked Interrupt Status (SSIMIS), offset 0x01C**

The **SSIMIS** register is the masked interrupt status register. On a read, this register gives the current masked status value of the corresponding interrupt. A write has no effect.

SSI Masked Interrupt Status (SSIMIS)

Offset 0x01C

|       |          |    |    |    |    |    |    |    |    |    |    |    |       |       |       |        |
|-------|----------|----|----|----|----|----|----|----|----|----|----|----|-------|-------|-------|--------|
|       | 31       | 30 | 29 | 28 | 27 | 26 | 25 | 24 | 23 | 22 | 21 | 20 | 19    | 18    | 17    | 16     |
|       | reserved |    |    |    |    |    |    |    |    |    |    |    |       |       |       |        |
| Type  | RO       | RO | RO | RO | RO | RO | RO | RO | RO | RO | RO | RO | RO    | RO    | RO    | RO     |
| Reset | 0        | 0  | 0  | 0  | 0  | 0  | 0  | 0  | 0  | 0  | 0  | 0  | 0     | 0     | 0     | 0      |
|       | 15       | 14 | 13 | 12 | 11 | 10 | 9  | 8  | 7  | 6  | 5  | 4  | 3     | 2     | 1     | 0      |
|       | reserved |    |    |    |    |    |    |    |    |    |    |    | TXMIS | RXMIS | RTMIS | RORMIS |
| Type  | RO       | RO | RO | RO | RO | RO | RO | RO | RO | RO | RO | RO | RO    | RO    | RO    | RO     |
| Reset | 0        | 0  | 0  | 0  | 0  | 0  | 0  | 0  | 0  | 0  | 0  | 0  | 0     | 0     | 0     | 0      |

| Bit/Field | Name     | Type | Reset | Description   |
|-----------|----------|------|-------|---|
| 31:4      | reserved | RO   | 0     | Reserved bits return an indeterminate value, and should never be changed.                                     |
| 3         | TXMIS    | RO   | 0     | SSI Transmit FIFO Masked Interrupt Status<br>Indicates that the transmit FIFO is half full or less, when set. |
| 2         | RXMIS    | RO   | 0     | SSI Receive FIFO Masked Interrupt Status<br>Indicates that the receive FIFO is half full or more, when set.   |
| 1         | RTMIS    | RO   | 0     | SSI Receive Time-Out Masked Interrupt Status<br>Indicates that the receive time-out has occurred, when set.   |
| 0         | RORMIS   | RO   | 0     | SSI Receive Overrun Masked Interrupt Status<br>Indicates that the receive FIFO has overflowed, when set.      |

**Register 9: SSI Interrupt Clear (SSIICR), offset 0x020**

The **SSIICR** register is the interrupt clear register. On a write of 1, the corresponding interrupt is cleared. A write of 0 has no effect.

SSI Interrupt Clear (SSIICR)

Offset 0x020

|       |          |    |    |    |    |    |    |    |    |    |    |    |    |    |      |       |     |
|-------|----------|----|----|----|----|----|----|----|----|----|----|----|----|----|------|-------|-----|
|       | 31       | 30 | 29 | 28 | 27 | 26 | 25 | 24 | 23 | 22 | 21 | 20 | 19 | 18 | 17   | 16    |     |
|       | reserved |    |    |    |    |    |    |    |    |    |    |    |    |    |      |       |     |
| Type  | RO       | RO | RO | RO | RO | RO | RO | RO | RO | RO | RO | RO | RO | RO | RO   | RO    |     |
| Reset | 0        | 0  | 0  | 0  | 0  | 0  | 0  | 0  | 0  | 0  | 0  | 0  | 0  | 0  | 0    | 0     |     |
|       | 15       | 14 | 13 | 12 | 11 | 10 | 9  | 8  | 7  | 6  | 5  | 4  | 3  | 2  | 1    | 0     |     |
|       | reserved |    |    |    |    |    |    |    |    |    |    |    |    |    | RTIC | RORIC |     |
| Type  | RO       | RO | RO | RO | RO | RO | RO | RO | RO | RO | RO | RO | RO | RO | RO   | W1C   | W1C |
| Reset | 0        | 0  | 0  | 0  | 0  | 0  | 0  | 0  | 0  | 0  | 0  | 0  | 0  | 0  | 0    | 0     | 0   |

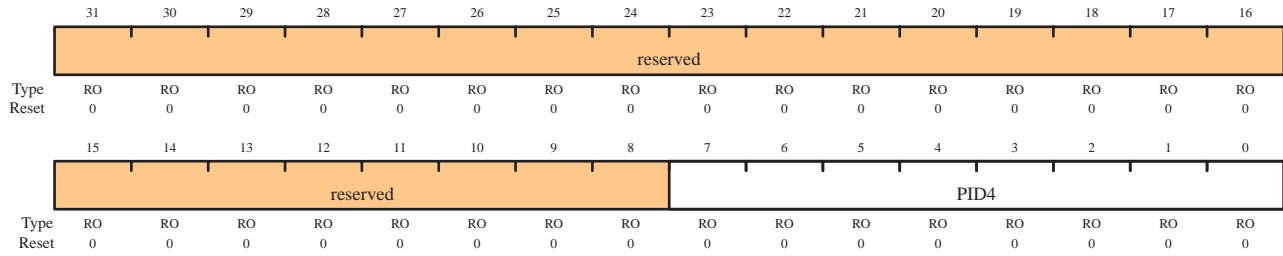
| Bit/Field | Name     | Type | Reset | Description  |
|-----------|----------|------|-------|--|
| 31:2      | reserved | RO   | 0     | Reserved bits return an indeterminate value, and should never be changed.                  |
| 1         | RTIC     | W1C  | 0     | SSI Receive Time-Out Interrupt Clear<br>0: No effect on interrupt.<br>1: Clears interrupt. |
| 0         | RORIC    | W1C  | 0     | SSI Receive Overrun Interrupt Clear<br>0: No effect on interrupt.<br>1: Clears interrupt.  |

**Register 10: SSI Peripheral Identification 4 (SSIPeriphID4), offset 0xFD0**

The **SSIPeriphIDn** registers are hard-coded and the fields within the register determine the reset value.

SSI Peripheral Identification 4 (SSIPeriphID4)

Offset 0xFD0



| Bit/Field | Name     | Type | Reset | Description   |
|-----------|----------|------|-------|---|
| 31:8      | reserved | RO   | 0     | Reserved bits return an indeterminate value, and should never be changed. |
| 7:0       | PID4     | RO   | 0x00  | SSI Peripheral ID Register[7:0]   |

**Register 11: SSI Peripheral Identification 5 (SSIPeriphID5), offset 0xFD4**

The **SSIPeriphIDn** registers are hard-coded and the fields within the register determine the reset value.

SSI Peripheral Identification 5 (SSIPeriphID5)

Offset 0xFD4

|       |          |    |    |    |    |    |    |    |      |    |    |    |    |    |    |    |
|-------|----------|----|----|----|----|----|----|----|------|----|----|----|----|----|----|----|
|       | 31       | 30 | 29 | 28 | 27 | 26 | 25 | 24 | 23   | 22 | 21 | 20 | 19 | 18 | 17 | 16 |
|       | reserved |    |    |    |    |    |    |    |      |    |    |    |    |    |    |    |
| Type  | RO       | RO | RO | RO | RO | RO | RO | RO | RO   | RO | RO | RO | RO | RO | RO | RO |
| Reset | 0        | 0  | 0  | 0  | 0  | 0  | 0  | 0  | 0    | 0  | 0  | 0  | 0  | 0  | 0  | 0  |
|       | 15       | 14 | 13 | 12 | 11 | 10 | 9  | 8  | 7    | 6  | 5  | 4  | 3  | 2  | 1  | 0  |
|       | reserved |    |    |    |    |    |    |    | PID5 |    |    |    |    |    |    |    |
| Type  | RO       | RO | RO | RO | RO | RO | RO | RO | RO   | RO | RO | RO | RO | RO | RO | RO |
| Reset | 0        | 0  | 0  | 0  | 0  | 0  | 0  | 0  | 0    | 0  | 0  | 0  | 0  | 0  | 0  | 0  |

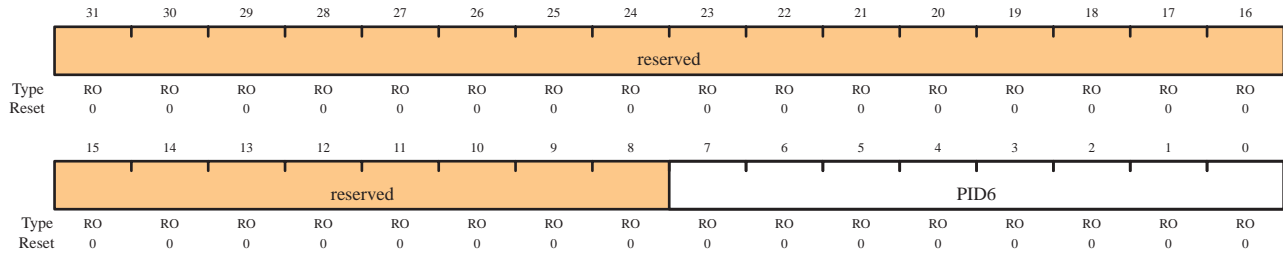
| Bit/Field | Name     | Type | Reset | Description   |
|-----------|----------|------|-------|---|
| 31:8      | reserved | RO   | 0     | Reserved bits return an indeterminate value, and should never be changed. |
| 7:0       | PID5     | RO   | 0x00  | SSI Peripheral ID Register[15:8]  |

**Register 12: SSI Peripheral Identification 6 (SSIPeriphID6), offset 0xFD8**

The **SSIPeriphIDn** registers are hard-coded and the fields within the register determine the reset value.

SSI Peripheral Identification 6 (SSIPeriphID6)

Offset 0xFD8



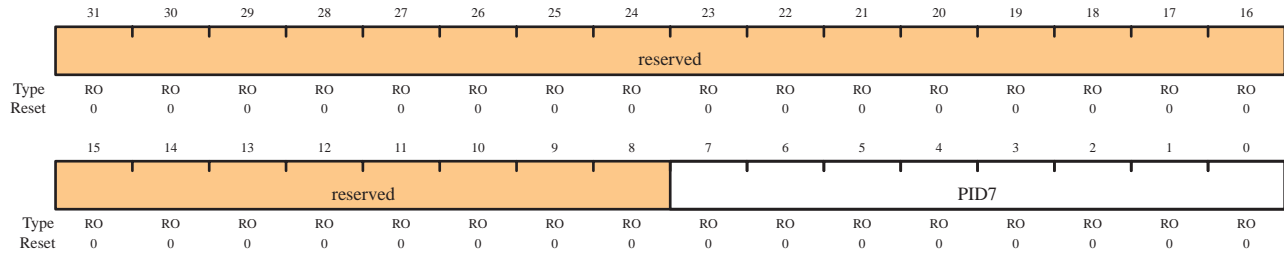
| Bit/Field | Name     | Type | Reset | Description   |
|-----------|----------|------|-------|---|
| 31:8      | reserved | RO   | 0     | Reserved bits return an indeterminate value, and should never be changed. |
| 7:0       | PID6     | RO   | 0x00  | SSI Peripheral ID Register[23:16]   |

**Register 13: SSI Peripheral Identification 7 (SSIPeriphID7), offset 0xFDC**

The **SSIPeriphIDn** registers are hard-coded and the fields within the register determine the reset value.

SSI Peripheral Identification 7 (SSIPeriphID7)

Offset 0xFDC



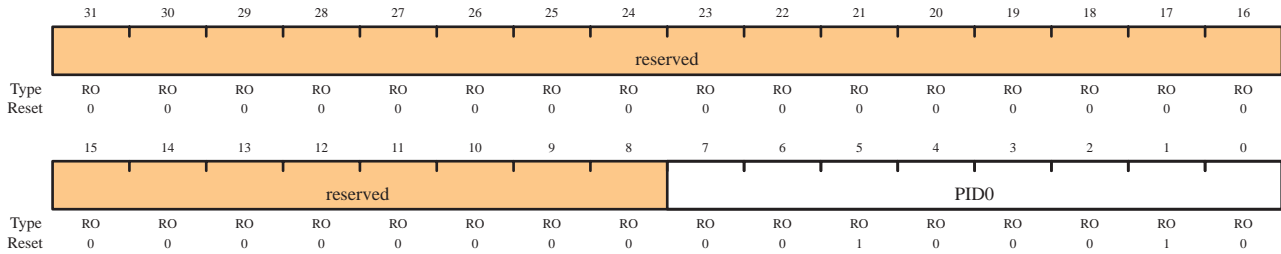
| Bit/Field | Name     | Type | Reset | Description   |
|-----------|----------|------|-------|---|
| 31:8      | reserved | RO   | 0     | Reserved bits return an indeterminate value, and should never be changed. |
| 7:0       | PID7     | RO   | 0x00  | SSI Peripheral ID Register[31:24]   |

**Register 14: SSI Peripheral Identification 0 (SSIPeriphID0), offset 0xFE0**

The **SSIPeriphIDn** registers are hard-coded and the fields within the register determine the reset value.

SSI Peripheral Identification 0 (SSIPeriphID0)

Offset 0xFE0



| Bit/Field | Name     | Type | Reset | Description   |
|-----------|----------|------|-------|---|
| 31:8      | reserved | RO   | 0     | Reserved bits return an indeterminate value, and should never be changed.                               |
| 7:0       | PID0     | RO   | 0x22  | SSI Peripheral ID Register[7:0]<br>Can be used by software to identify the presence of this peripheral. |



**Register 15: SSI Peripheral Identification 1 (SSIPeriphID1), offset 0xFE4**

The **SSIPeriphIDn** registers are hard-coded and the fields within the register determine the reset value.

## SSI Peripheral Identification 1 (SSIPeriphID1)

Offset 0xFE4

|       |          |    |    |    |    |    |    |    |      |    |    |    |    |    |    |    |
|-------|----------|----|----|----|----|----|----|----|------|----|----|----|----|----|----|----|
|       | 31       | 30 | 29 | 28 | 27 | 26 | 25 | 24 | 23   | 22 | 21 | 20 | 19 | 18 | 17 | 16 |
|       | reserved |    |    |    |    |    |    |    |      |    |    |    |    |    |    |    |
| Type  | RO       | RO | RO | RO | RO | RO | RO | RO | RO   | RO | RO | RO | RO | RO | RO | RO |
| Reset | 0        | 0  | 0  | 0  | 0  | 0  | 0  | 0  | 0    | 0  | 0  | 0  | 0  | 0  | 0  | 0  |
|       | 15       | 14 | 13 | 12 | 11 | 10 | 9  | 8  | 7    | 6  | 5  | 4  | 3  | 2  | 1  | 0  |
|       | reserved |    |    |    |    |    |    |    | PID1 |    |    |    |    |    |    |    |
| Type  | RO       | RO | RO | RO | RO | RO | RO | RO | RO   | RO | RO | RO | RO | RO | RO | RO |
| Reset | 0        | 0  | 0  | 0  | 0  | 0  | 0  | 0  | 0    | 0  | 0  | 0  | 0  | 0  | 0  | 0  |

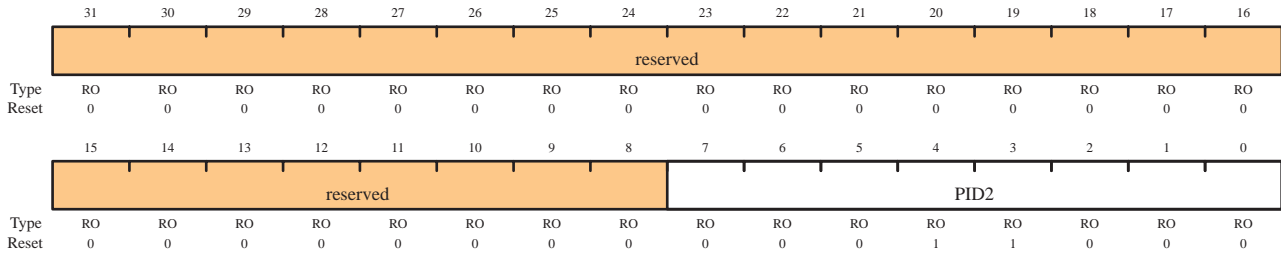
| Bit/Field | Name     | Type | Reset | Description   |
|-----------|----------|------|-------|---|
| 31:8      | reserved | RO   | 0     | Reserved bits return an indeterminate value, and should never be changed.                                 |
| 7:0       | PID1     | RO   | 0x00  | SSI Peripheral ID Register [15:8]<br>Can be used by software to identify the presence of this peripheral. |

**Register 16: SSI Peripheral Identification 2 (SSIPeriphID2), offset 0xFE8**

The **SSIPeriphIDn** registers are hard-coded and the fields within the register determine the reset value.

SSI Peripheral Identification 2 (SSIPeriphID2)

Offset 0xFE8



| Bit/Field | Name     | Type | Reset | Description  |
|-----------|----------|------|-------|--|
| 31:8      | reserved | RO   | 0     | Reserved bits return an indeterminate value, and should never be changed.                                  |
| 7:0       | PID2     | RO   | 0x18  | SSI Peripheral ID Register [23:16]<br>Can be used by software to identify the presence of this peripheral. |

**Register 17: SSI Peripheral Identification 3 (SSIPeriphID3), offset 0xFEC**

The **SSIPeriphIDn** registers are hard-coded and the fields within the register determine the reset value.

## SSI Peripheral Identification 3 (SSIPeriphID3)

Offset 0xFEC

|       |          |    |    |    |    |    |    |    |      |    |    |    |    |    |    |    |
|-------|----------|----|----|----|----|----|----|----|------|----|----|----|----|----|----|----|
|       | 31       | 30 | 29 | 28 | 27 | 26 | 25 | 24 | 23   | 22 | 21 | 20 | 19 | 18 | 17 | 16 |
|       | reserved |    |    |    |    |    |    |    |      |    |    |    |    |    |    |    |
| Type  | RO       | RO | RO | RO | RO | RO | RO | RO | RO   | RO | RO | RO | RO | RO | RO | RO |
| Reset | 0        | 0  | 0  | 0  | 0  | 0  | 0  | 0  | 0    | 0  | 0  | 0  | 0  | 0  | 0  | 0  |
|       | 15       | 14 | 13 | 12 | 11 | 10 | 9  | 8  | 7    | 6  | 5  | 4  | 3  | 2  | 1  | 0  |
|       | reserved |    |    |    |    |    |    |    | PID3 |    |    |    |    |    |    |    |
| Type  | RO       | RO | RO | RO | RO | RO | RO | RO | RO   | RO | RO | RO | RO | RO | RO | RO |
| Reset | 0        | 0  | 0  | 0  | 0  | 0  | 0  | 0  | 0    | 0  | 0  | 0  | 0  | 0  | 0  | 1  |

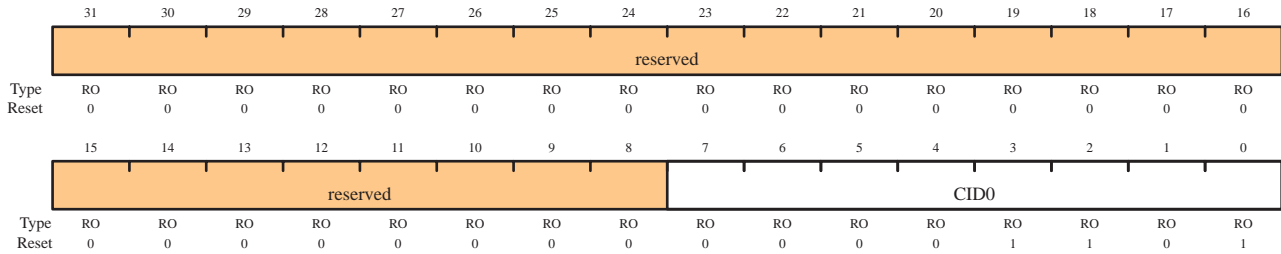
| Bit/Field | Name     | Type | Reset | Description  |
|-----------|----------|------|-------|--|
| 31:8      | reserved | RO   | 0     | Reserved bits return an indeterminate value, and should never be changed.                                  |
| 7:0       | PID3     | RO   | 0x01  | SSI Peripheral ID Register [31:24]<br>Can be used by software to identify the presence of this peripheral. |

**Register 18: SSI PrimeCell Identification 0 (SSIPCellIID0), offset 0xFF0**

The **SSIPCellIIDn** registers are hard-coded and the fields within the register determine the reset value.

SSI Primecell Identification 0 (SSIPCellIID0)

Offset 0xFF0



| Bit/Field | Name     | Type | Reset | Description   |
|-----------|----------|------|-------|---|
| 31:8      | reserved | RO   | 0     | Reserved bits return an indeterminate value, and should never be changed.                               |
| 7:0       | CID0     | RO   | 0x0D  | SSI PrimeCell ID Register [7:0]<br>Provides software a standard cross-peripheral identification system. |

**Register 19: SSI PrimeCell Identification 1 (SSIPCellID1), offset 0xFF4**

The **SSIPCellIDn** registers are hard-coded and the fields within the register determine the reset value.

## SSI Primecell Identification 1 (SSIPCellID1)

Offset 0xFF4

|       |          |    |    |    |    |    |    |    |      |    |    |    |    |    |    |    |
|-------|----------|----|----|----|----|----|----|----|------|----|----|----|----|----|----|----|
|       | 31       | 30 | 29 | 28 | 27 | 26 | 25 | 24 | 23   | 22 | 21 | 20 | 19 | 18 | 17 | 16 |
|       | reserved |    |    |    |    |    |    |    |      |    |    |    |    |    |    |    |
| Type  | RO       | RO | RO | RO | RO | RO | RO | RO | RO   | RO | RO | RO | RO | RO | RO | RO |
| Reset | 0        | 0  | 0  | 0  | 0  | 0  | 0  | 0  | 0    | 0  | 0  | 0  | 0  | 0  | 0  | 0  |
|       | 15       | 14 | 13 | 12 | 11 | 10 | 9  | 8  | 7    | 6  | 5  | 4  | 3  | 2  | 1  | 0  |
|       | reserved |    |    |    |    |    |    |    | CID1 |    |    |    |    |    |    |    |
| Type  | RO       | RO | RO | RO | RO | RO | RO | RO | RO   | RO | RO | RO | RO | RO | RO | RO |
| Reset | 0        | 0  | 0  | 0  | 0  | 0  | 0  | 0  | 1    | 1  | 1  | 1  | 0  | 0  | 0  | 0  |

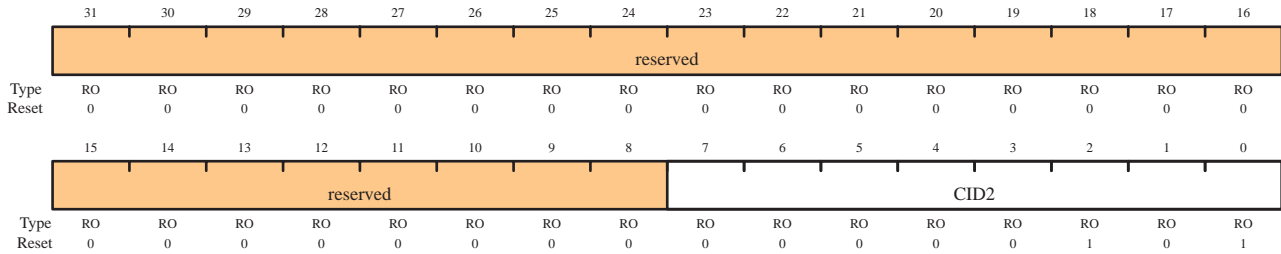
| Bit/Field | Name     | Type | Reset | Description  |
|-----------|----------|------|-------|--|
| 31:8      | reserved | RO   | 0     | Reserved bits return an indeterminate value, and should never be changed.                                |
| 7:0       | CID1     | RO   | 0xF0  | SSI PrimeCell ID Register [15:8]<br>Provides software a standard cross-peripheral identification system. |

**Register 20: SSI PrimeCell Identification 2 (SSIPCellID2), offset 0xFF8**

The **SSIPCellIDn** registers are hard-coded and the fields within the register determine the reset value.

SSI Primecell Identification 2 (SSIPCellID2)

Offset 0xFF8



| Bit/Field | Name     | Type | Reset | Description   |
|-----------|----------|------|-------|---|
| 31:8      | reserved | RO   | 0     | Reserved bits return an indeterminate value, and should never be changed.                                 |
| 7:0       | CID2     | RO   | 0x05  | SSI PrimeCell ID Register [23:16]<br>Provides software a standard cross-peripheral identification system. |

**Register 21: SSI PrimeCell Identification 3 (SSIPCellID3), offset 0xFFC**

The **SSIPCellIDn** registers are hard-coded and the fields within the register determine the reset value.

## SSI Primecell Identification 3 (SSIPCellID3)

Offset 0xFFC

|       |          |    |    |    |    |    |    |    |      |    |    |    |    |    |    |    |
|-------|----------|----|----|----|----|----|----|----|------|----|----|----|----|----|----|----|
|       | 31       | 30 | 29 | 28 | 27 | 26 | 25 | 24 | 23   | 22 | 21 | 20 | 19 | 18 | 17 | 16 |
|       | reserved |    |    |    |    |    |    |    |      |    |    |    |    |    |    |    |
| Type  | RO       | RO | RO | RO | RO | RO | RO | RO | RO   | RO | RO | RO | RO | RO | RO | RO |
| Reset | 0        | 0  | 0  | 0  | 0  | 0  | 0  | 0  | 0    | 0  | 0  | 0  | 0  | 0  | 0  | 0  |
|       | 15       | 14 | 13 | 12 | 11 | 10 | 9  | 8  | 7    | 6  | 5  | 4  | 3  | 2  | 1  | 0  |
|       | reserved |    |    |    |    |    |    |    | CID3 |    |    |    |    |    |    |    |
| Type  | RO       | RO | RO | RO | RO | RO | RO | RO | RO   | RO | RO | RO | RO | RO | RO | RO |
| Reset | 0        | 0  | 0  | 0  | 0  | 0  | 0  | 0  | 1    | 0  | 1  | 1  | 0  | 0  | 0  | 1  |

| Bit/Field | Name     | Type | Reset | Description   |
|-----------|----------|------|-------|---|
| 31:8      | reserved | RO   | 0     | Reserved bits return an indeterminate value, and should never be changed.                                 |
| 7:0       | CID3     | RO   | 0xB1  | SSI PrimeCell ID Register [31:24]<br>Provides software a standard cross-peripheral identification system. |

## 14 Inter-Integrated Circuit (I<sup>2</sup>C) Interface

The Inter-Integrated Circuit (I<sup>2</sup>C) bus provides bi-directional data transfer through a two-wire design (a serial data line SDL and a serial clock line SCL).

The I<sup>2</sup>C bus interfaces to external I<sup>2</sup>C devices such as serial memory (RAMs and ROMs), networking devices, LCDs, tone generators, and so on. The I<sup>2</sup>C bus may also be used for system testing and diagnostic purposes in product development and manufacture.

The Stellaris I<sup>2</sup>C module provides the ability to communicate to other IC devices over an I<sup>2</sup>C bus. The I<sup>2</sup>C bus supports devices that can both transmit and receive (write and read) data.

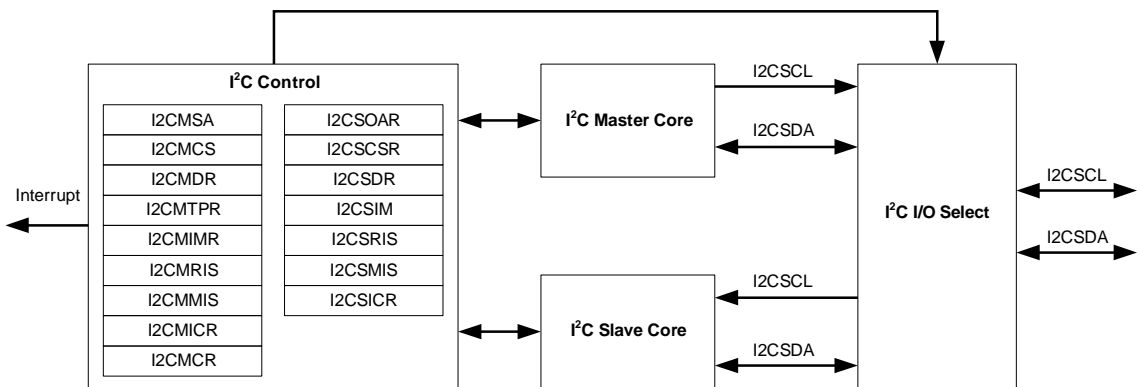
Devices on the I<sup>2</sup>C bus can be designated as either a master or a slave. The I<sup>2</sup>C module supports both sending and receiving data as either a master or a slave, and also supports the simultaneous operation as both a master and a slave. The four I<sup>2</sup>C modes are: Master Transmit, Master Receive, Slave Transmit, and Slave Receive.

The Stellaris I<sup>2</sup>C module can operate at two speeds: Standard (100 Kbps) and Fast (400 Kbps).

Both the I<sup>2</sup>C master and slave can generate interrupts. The I<sup>2</sup>C master generates interrupts when a transmit or receive operation completes (or aborts due to an error). The I<sup>2</sup>C slave generates interrupts when data has been sent or requested by a master.

### 14.1 Block Diagram

Figure 14-1. I<sup>2</sup>C Block Diagram

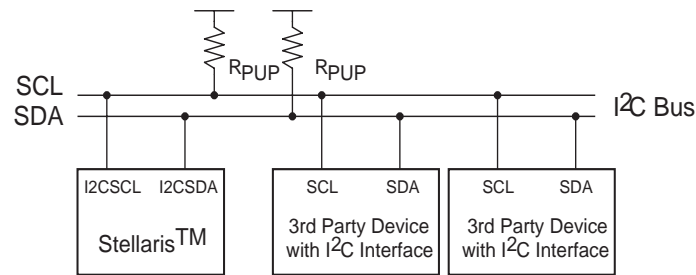


### 14.2 Functional Description

The I<sup>2</sup>C module is comprised of both a master and slave function. The master and slave functions are implemented as separate peripherals. The I<sup>2</sup>C module must be connected to bi-directional Open-Drain pads. A typical I<sup>2</sup>C bus configuration is shown in Figure 14-2.

See "I<sup>2</sup>C Timing" on page 343 for I<sup>2</sup>C timing diagrams.



Figure 14-2. I<sup>2</sup>C Bus Configuration

## 14.2.1 I<sup>2</sup>C Bus Functional Overview

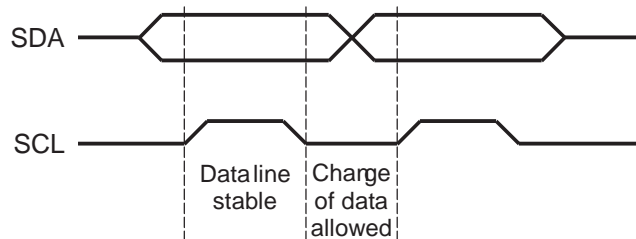
The I<sup>2</sup>C bus uses only two signals: SDA and SCL, named I2CSDA and I2CSCL on Stellaris microcontrollers. SDA is the bi-directional serial data line and SCL is the bi-directional serial clock line.

### 14.2.1.1 Data Transfers

Both the SDA and SCL lines are bi-directional, connected to the positive supply via pull-up resistors. The bus is idle or free, when both lines are High. The output devices (pad drivers) must have an open-drain configuration. Data on the I<sup>2</sup>C bus can be transferred at rates up to 100 Kbps in Standard mode and up to 400 Kbps in Fast mode.

### 14.2.1.2 Data Validity

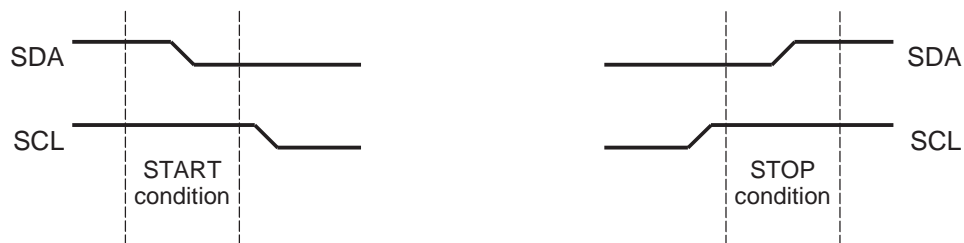
The data on the SDA line must be stable during the High period of the clock. The data line can only change when the clock SCL is in its Low state (see Figure 14-3).

Figure 14-3. Data Validity During Bit Transfer on the I<sup>2</sup>C Bus

### 14.2.1.3 START and STOP Conditions

The protocol of the I<sup>2</sup>C bus defines two states: START and STOP. A High-to-Low transition on the SDA line while the SCL is High is a START condition. A Low-to-High transition on the SDA line while SCL is High is defined as a STOP condition. The bus is considered busy after a START condition. The bus is considered free after a STOP condition. See Figure 14-4.

Figure 14-4. START and STOP Conditions



**14.2.1.4 Byte Format**

Every byte put out on the SDA line must be 8-bits long. The number of bytes per transfer is unrestricted. Each byte has to be followed by an Acknowledge bit. Data is transferred with the MSB first. When a receiver cannot receive another complete byte, it can hold the clock line SCL Low and force the transmitter into a wait state. The data transfer continues when the receiver releases the clock SCL.

**14.2.1.5 Acknowledge**

Data transfer with an acknowledge is obligatory. The acknowledge-related clock pulse is generated by the master. The transmitter releases the SDA line during the acknowledge clock pulse.

The receiver must pull down SDA during the acknowledge clock pulse such that it remains stable (Low) during the High period of the acknowledge clock pulse.

When a slave receiver does not acknowledge the slave address, the data line must be left in a High state by the slave. The master can then generate a STOP condition to abort the current transfer.

If the master receiver is involved in the transfer, it must signal the end of data to the slave-transmitter by not generating an acknowledge on the last byte that was clocked out of the slave. The slave-transmitter must release the SDA line to allow the master to generate the STOP or a repeated START condition.

**14.2.1.6 Arbitration**

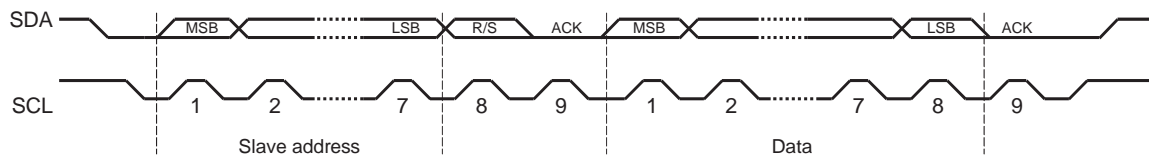
A master may start a transfer only if the bus is idle. Two or more masters may generate a START condition within minimum hold time of the START condition. Arbitration takes place on the SDA line, while SCL is in the High state, in such a manner that the master transmitting a High level (while another master is transmitting a Low level) will switch off its data output stage.

Arbitration can be over several bits. Its first stage is a comparison of address bits. If both masters are trying to address the same device, arbitration continues with comparison of data bits.

**14.2.1.7 Data Format with 7-Bit Address**

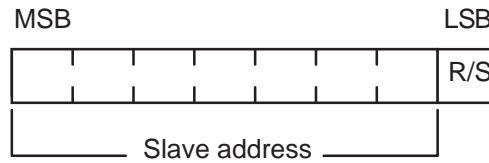
Data transfers follow the format shown in Figure 14-5. After the START condition, a slave address is sent. This address is 7-bits long followed by an eighth bit, which is a data direction bit (R/S bit in the **I2CMSA** register). A zero indicates a transmission (Send); a one indicates a request for data (Receive). A data transfer is always terminated by a STOP condition generated by the master. However, a master can still communicate on the bus by generating a repeated START condition and addressing another slave without first generating a STOP condition. Various combinations of receive/send formats are then possible within such a transfer.

**Figure 14-5. Complete Data Transfer with a 7-Bit Address**



The first seven bits of the first byte make up the slave address (see Figure 14-6). The eighth bit determines the direction of the message. A zero in the R/S position of the first byte means that the master will write (send) information to a selected slave. A one in this position means that the master will receive information from the slave.

Figure 14-6. R/S Bit in First Byte



14.2.1.8 I<sup>2</sup>C Master Command Sequences

Figure 14-7 through Figure 14-12 present the command sequences available for the I<sup>2</sup>C master.

Figure 14-7. Master Single SEND

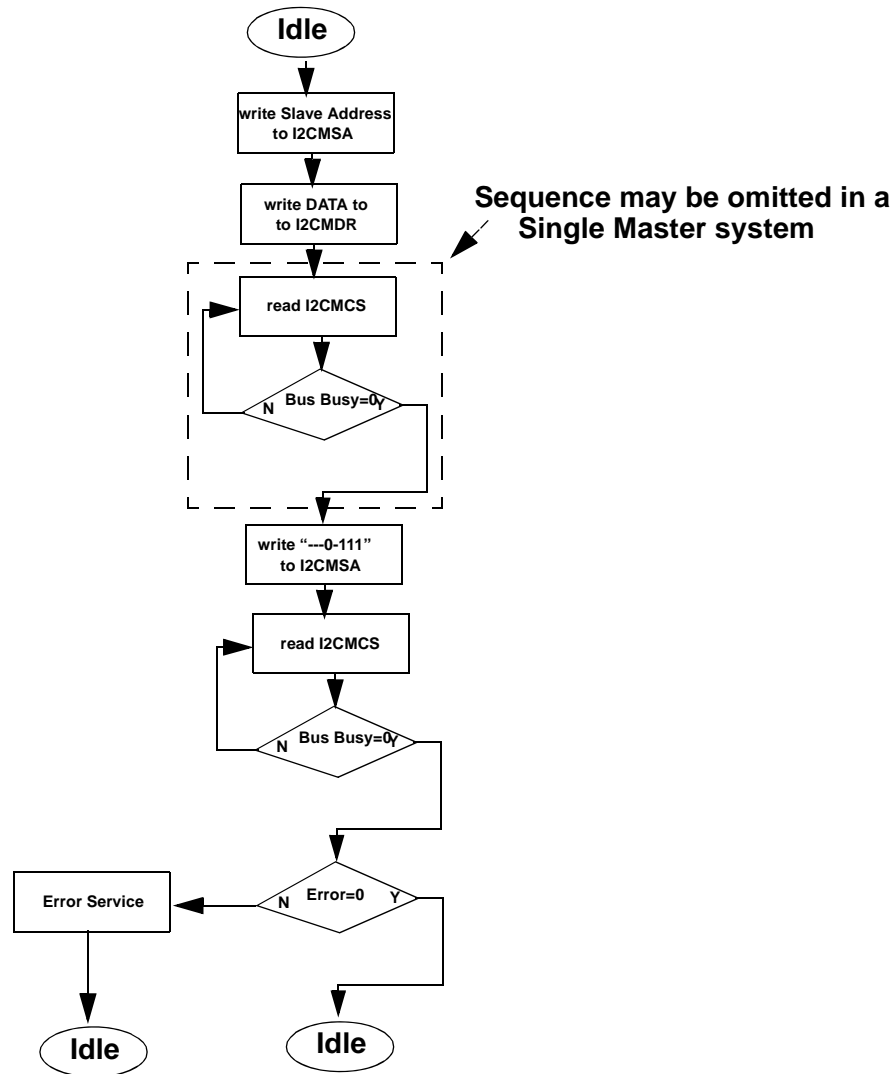


Figure 14-8. Master Single RECEIVE

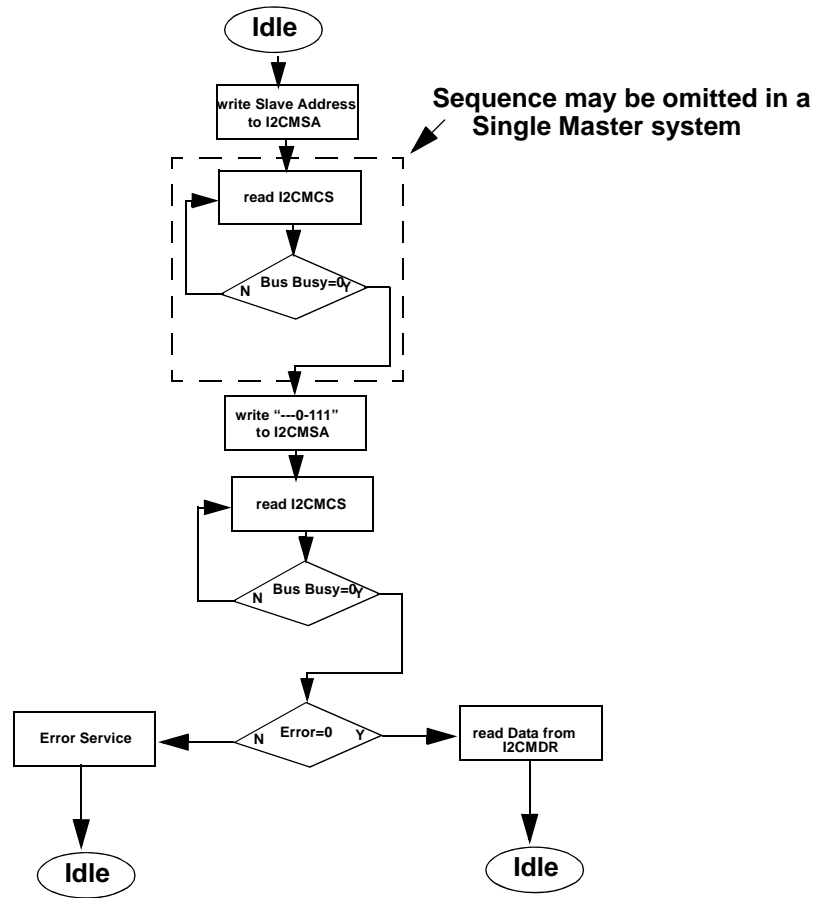


Figure 14-9. Master Burst SEND

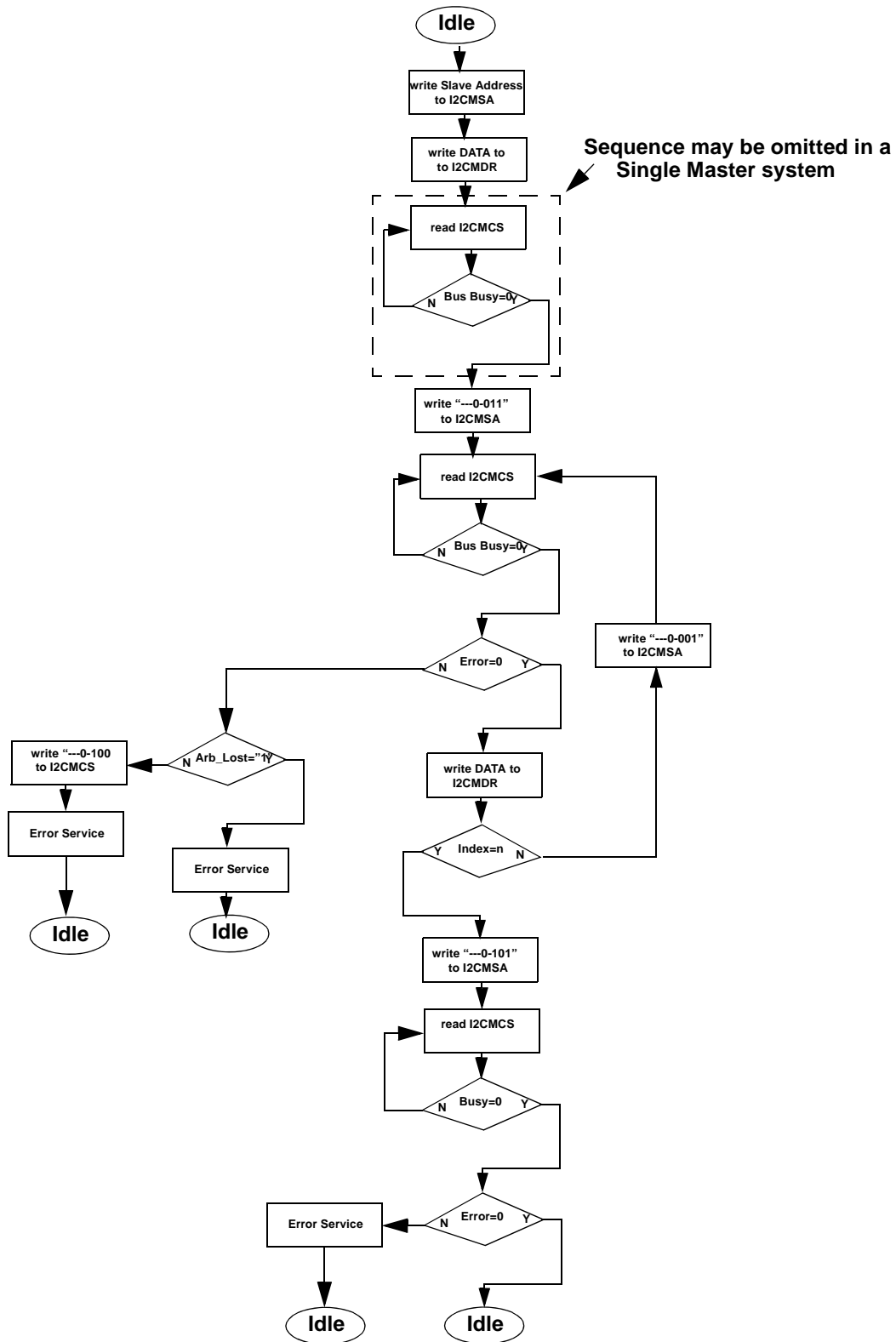


Figure 14-10. Master Burst RECEIVE

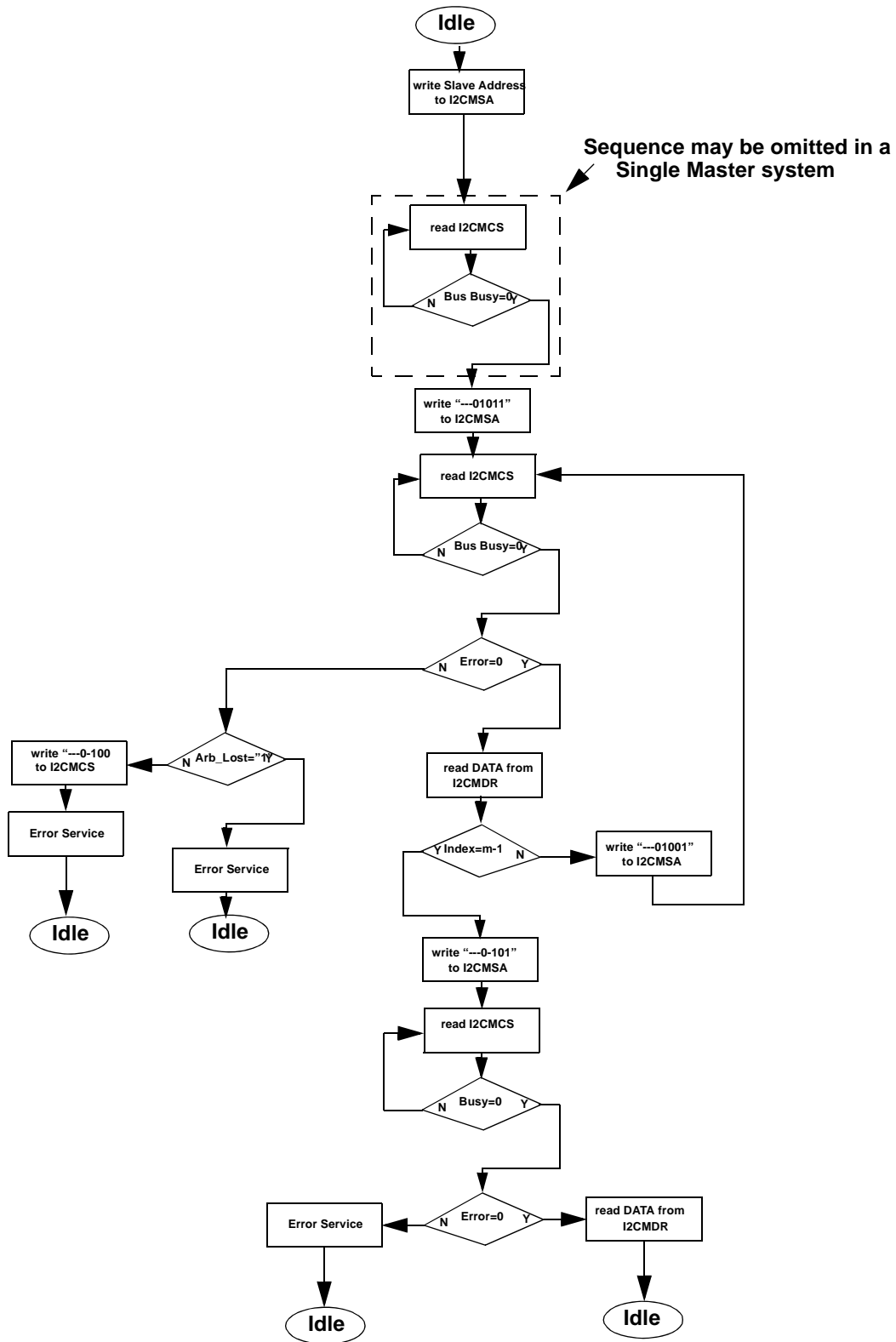


Figure 14-11. Master Burst RECEIVE after Burst SEND

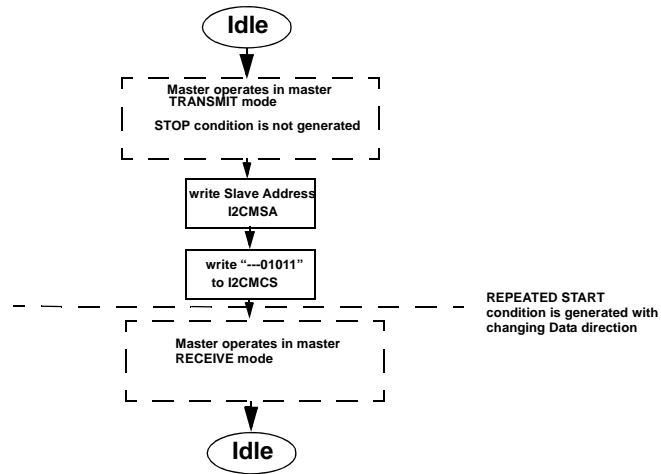
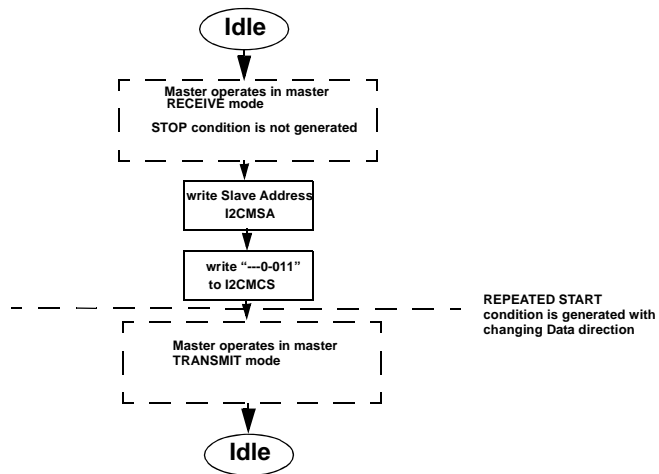


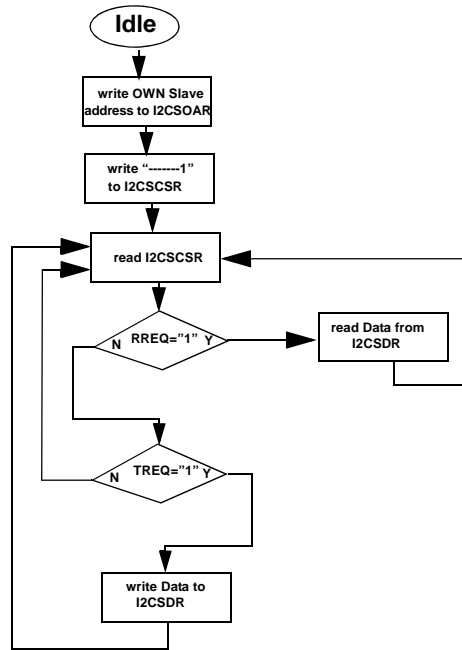
Figure 14-12. Master Burst SEND after Burst RECEIVE



14.2.1.9 I<sup>2</sup>C Slave Command Sequences

Figure 14-13 presents the command sequence available for the I<sup>2</sup>C slave.

Figure 14-13. Slave Command Sequence



### 14.2.2 Available Speed Modes

The SCL clock rate is determined by the parameters: CLK\_PRD, TIMER\_PRD, SCL\_LP, and SCL\_HP.

where:

CLK\_PRD is the system clock period

SCL\_LP is the Low phase of the SCL clock (fixed at 6)

SCL\_HP is the High phase of the SCL clock (fixed at 4)

TIMER\_PRD is the programmed value in the **I2C Master Timer Period (I2CMTPR)** register (see page 314).

The SCL clock period is calculated as follows:

$$SCL\_PERIOD = 2 * (1 + TIMER\_PRD) * (SCL\_LP + SCL\_HP) * CLK\_PRD$$

For example:

$$CLK\_PRD = 50 \text{ ns}$$

$$TIMER\_PRD = 2$$

$$SCL\_LP = 6$$

$$SCL\_HP = 4$$

yields a SCL frequency of:

$$1/T = 333 \text{ Khz}$$



Table 14-1 gives examples of Timer period, system clock, and speed mode (Standard or Fast).

**Table 14-1. Examples of I<sup>2</sup>C Master Timer Period versus Speed Mode**

| System Clock | Timer Period | Standard Mode | Timer Period | Fast Mode |
|--------------|--------------|---------------|--------------|-----------|
| 4 Mhz        | 0x01         | 100 Kbps      | -            | -         |
| 6 Mhz        | 0x02         | 100 Kbps      | -            | -         |
| 12.5 Mhz     | 0x06         | 89 Kbps       | 0x01         | 312 Kbps  |
| 16.7 Mhz     | 0x08         | 93 Kbps       | 0x02         | 278 Kbps  |
| 20 Mhz       | 0x09         | 100 Kbps      | 0x02         | 333 Kbps  |
| 25 Mhz       | 0x0C         | 96.2 Kbps     | 0x03         | 312 Kbps  |
| 33Mhz        | 0x10         | 97.1 Kbps     | 0x04         | 330 Kbps  |
| 40Mhz        | 0x13         | 100 Kbps      | 0x04         | 400 Kbps  |
| 50Mhz        | 0x18         | 100 Kbps      | 0x06         | 357 Kbps  |

### 14.3 Initialization and Configuration

The following example shows how to configure the I<sup>2</sup>C module to send a single byte as a master. This assumes the system clock is 20 MHz.

1. Enable the I<sup>2</sup>C clock by writing a value of 0x00001000 to the **RCGC1** register in the System Control module.
2. In the GPIO module, enable the appropriate pins for their alternate function using the **GPIOAFSEL** register. Also, be sure to enable the same pins for Open Drain operation.
3. Initialize the I<sup>2</sup>C Master by writing the **I2CMCR** register with a value of 0x00000020.
4. Set the desired SCL clock speed of 100 Kbps by writing the **I2CMTPR** register with the correct value. The value written to the **I2CMTPR** register represents the number of system clock periods in one SCL clock period. The TPR value is determined by the following equation:

$$\begin{aligned} \text{TPR} &= (\text{System Clock} / (2 * (\text{SCL\_LP} + \text{SCL\_HP}) * \text{SCL\_CLK})) - 1; \\ \text{TPR} &= (20\text{MHz} / (2 * (6 + 4) * 100000)) - 1; \\ \text{TPR} &= 9 \end{aligned}$$

Write the **I2CMTPR** register with the value of 0x00000009.

5. Specify the slave address of the master and that the next operation will be a Send by writing the **I2CMSA** register with a value of 0x00000076. This sets the slave address to 0x3B.
6. Place data (byte) to be sent in the data register by writing the **I2CMDR** register with the desired data.
7. Initiate a single byte send of the data from Master to Slave by writing the **I2CMCS** register with a value of 0x00000007 (STOP, START, RUN).
8. Wait until the transmission completes by polling the **I2CMCS** register's BUSBSY bit until it has been cleared.

## 14.4 Register Map

Table 14-2 lists the I<sup>2</sup>C registers. All addresses given are relative to the I<sup>2</sup>C base addresses for the master and slave:

- I<sup>2</sup>C Master: 0x40020000
- I<sup>2</sup>C Slave: 0x40020800

**Table 14-2. I<sup>2</sup>C Register Map**

| Offset | Name    | Reset      | Type | Description                    | See page |
|--------|---------|------------|------|--------------------------------|----------|
| 0x000  | I2CMSA  | 0x00000000 | R/W  | Master slave address           | 307      |
| 0x004  | I2CMCS  | 0x00000000 | R/W  | Master control/status          | 308      |
| 0x008  | I2CMDR  | 0x00000000 | R/W  | Master data                    | 313      |
| 0x00C  | I2CMTPR | 0x00000001 | R/W  | Master timer period            | 314      |
| 0x010  | I2CMIMR | 0x00000000 | R/W  | Master interrupt mask          | 315      |
| 0x014  | I2CMRIS | 0x00000000 | RO   | Master raw interrupt status    | 316      |
| 0x018  | I2CMMIS | 0x00000000 | RO   | Master masked interrupt status | 316      |
| 0x01C  | I2CMICR | 0x00000000 | WO   | Master interrupt clear         | 317      |
| 0x020  | I2CMCR  | 0x00000000 | R/W  | Master configuration           | 318      |
| 0x000  | I2CSOAR | 0x00000000 | R/W  | Slave address                  | 320      |
| 0x004  | I2CSCSR | 0x00000000 | RO   | Slave control/status           | 321      |
| 0x008  | I2CSDR  | 0x00000000 | R/W  | Slave data                     | 323      |
| 0x00C  | I2CSIMR | 0x00000000 | R/W  | Slave interrupt mask           | 324      |
| 0x010  | I2CSRIS | 0x00000000 | RO   | Slave raw interrupt status     | 325      |
| 0x014  | I2CSMIS | 0x00000000 | RO   | Slave masked interrupt status  | 326      |
| 0x018  | I2CSICR | 0x00000000 | WO   | Slave interrupt clear          | 327      |

## 14.5 Register Descriptions (I<sup>2</sup>C Master)

The remainder of this section lists and describes the I<sup>2</sup>C master registers, in numerical order by address offset. See also “Register Descriptions (I2C Slave)” on page 320.

**Register 1: I<sup>2</sup>C Master Slave Address (I2CMSA), offset 0x000**

This register consists of eight bits: seven address bits (A6-A0), and a Receive/Send bit, which determines if the next operation is a Receive (High), or Send (Low).

## I2C Master Slave Address (I2CMSA)

Offset 0x000

|       |          |    |    |    |    |    |    |    |     |     |     |     |     |     |     |     |
|-------|----------|----|----|----|----|----|----|----|-----|-----|-----|-----|-----|-----|-----|-----|
|       | 31       | 30 | 29 | 28 | 27 | 26 | 25 | 24 | 23  | 22  | 21  | 20  | 19  | 18  | 17  | 16  |
|       | reserved |    |    |    |    |    |    |    |     |     |     |     |     |     |     |     |
| Type  | RO       | RO | RO | RO | RO | RO | RO | RO | RO  | RO  | RO  | RO  | RO  | RO  | RO  | RO  |
| Reset | 0        | 0  | 0  | 0  | 0  | 0  | 0  | 0  | 0   | 0   | 0   | 0   | 0   | 0   | 0   | 0   |
|       | 15       | 14 | 13 | 12 | 11 | 10 | 9  | 8  | 7   | 6   | 5   | 4   | 3   | 2   | 1   | 0   |
|       | reserved |    |    |    |    |    |    |    | SA  |     |     |     |     |     |     | R/S |
| Type  | RO       | RO | RO | RO | RO | RO | RO | RO | R/W | R/W | R/W | R/W | R/W | R/W | R/W | R/W |
| Reset | 0        | 0  | 0  | 0  | 0  | 0  | 0  | 0  | 0   | 0   | 0   | 0   | 0   | 0   | 0   | 0   |

| Bit/Field | Name     | Type | Reset | Description   |
|-----------|----------|------|-------|---|
| 31:8      | reserved | RO   | 0     | Reserved bits return an indeterminate value, and should never be changed.   |
| 7:1       | SA       | R/W  | 0     | I <sup>2</sup> C Slave Address<br>This field specifies bits A6 through A0 of the slave address.                         |
| 0         | R/S      | R/W  | 0     | Receive/Send<br>The R/S bit specifies if the next operation is a Receive (High) or Send (Low).<br>0: Send<br>1: Receive |

**Register 2: I<sup>2</sup>C Master Control/Status (I2CMCS), offset 0x004**

This register accesses four control bits when written, and accesses seven status bits when read.

The status register consists of seven bits, which when read determine the state of the I<sup>2</sup>C bus controller.

The control register consists of four bits: the RUN, STOP, START, and ACK bits.

The START bit causes the generation of the START, or REPEATED START condition.

The STOP bit determines if the cycle stops at the end of the data cycle, or continues on to a burst. To generate a single send cycle, the **I2C Master Slave Address (I2CMSA)** register is written with the desired address, the R/S bit is set to 0, and the Control register is written with ACK=X (0 or 1), STOP=1, START=1, and RUN=1 to perform the operation and stop. When the operation is completed (or aborted due an error), the interrupt pin becomes active and the data may be read from the **I2CMDR** register. When the I<sup>2</sup>C module operates in Master receiver mode, the ACK bit must be set normally to logic 1. This causes the I<sup>2</sup>C bus controller to send an acknowledge automatically after each byte. This bit must be reset when the I<sup>2</sup>C bus controller requires no further data to be sent from the slave transmitter.

I2C Master Status (I2CMCS): Read  
Offset 0x004

|       |          |    |    |    |    |    |    |    |    |    |        |      |        |         |        |       |      |
|-------|----------|----|----|----|----|----|----|----|----|----|--------|------|--------|---------|--------|-------|------|
|       | 31       | 30 | 29 | 28 | 27 | 26 | 25 | 24 | 23 | 22 | 21     | 20   | 19     | 18      | 17     | 16    |      |
|       | reserved |    |    |    |    |    |    |    |    |    |        |      |        |         |        |       |      |
| Type  | RO       | RO | RO | RO | RO | RO | RO | RO | RO | RO | RO     | RO   | RO     | RO      | RO     | RO    |      |
| Reset | 0        | 0  | 0  | 0  | 0  | 0  | 0  | 0  | 0  | 0  | 0      | 0    | 0      | 0       | 0      | 0     |      |
|       | 15       | 14 | 13 | 12 | 11 | 10 | 9  | 8  | 7  | 6  | 5      | 4    | 3      | 2       | 1      | 0     |      |
|       | reserved |    |    |    |    |    |    |    |    |    | BUSBSY | IDLE | ARBLST | DATAACK | ADRACK | ERROR | BUSY |
| Type  | RO       | RO | RO | RO | RO | RO | RO | RO | RO | RO | RO     | RO   | RO     | RO      | RO     | RO    |      |
| Reset | 0        | 0  | 0  | 0  | 0  | 0  | 0  | 0  | 0  | 0  | 0      | 0    | 0      | 0       | 0      | 0     |      |

I2C Master Control (I2CMCS): Write  
Offset 0x004

|       |          |    |    |    |    |    |    |    |    |    |    |    |     |      |       |     |    |
|-------|----------|----|----|----|----|----|----|----|----|----|----|----|-----|------|-------|-----|----|
|       | 31       | 30 | 29 | 28 | 27 | 26 | 25 | 24 | 23 | 22 | 21 | 20 | 19  | 18   | 17    | 16  |    |
|       | reserved |    |    |    |    |    |    |    |    |    |    |    |     |      |       |     |    |
| Type  | RO       | RO | RO | RO | RO | RO | RO | RO | RO | RO | RO | RO | RO  | RO   | RO    | RO  |    |
| Reset | 0        | 0  | 0  | 0  | 0  | 0  | 0  | 0  | 0  | 0  | 0  | 0  | 0   | 0    | 0     | 0   |    |
|       | 15       | 14 | 13 | 12 | 11 | 10 | 9  | 8  | 7  | 6  | 5  | 4  | 3   | 2    | 1     | 0   |    |
|       | reserved |    |    |    |    |    |    |    |    |    |    |    | ACK | STOP | START | RUN |    |
| Type  | RO       | RO | RO | RO | RO | RO | RO | RO | RO | RO | RO | RO | RO  | WO   | WO    | WO  | WO |
| Reset | 0        | 0  | 0  | 0  | 0  | 0  | 0  | 0  | 0  | 0  | 0  | 0  | 0   | 0    | 0     | 0   | 0  |

| Bit/Field | Name | Type | Reset | Description |
|-----------|------|------|-------|-------------|
|-----------|------|------|-------|-------------|

**Read-Only Status Register**

|      |          |    |   |  |
|------|----------|----|---|--|
| 31:7 | reserved | RO | 0 | Reserved bits return an indeterminate value, and should never be changed.  |
| 6    | BUSBSY   | R  | 0 | This bit specifies the state of the I <sup>2</sup> C bus. If set, the bus is busy; otherwise, the bus is idle. The bit changes based on the START and STOP conditions. |
| 5    | IDLE     | R  | 0 | This bit specifies the I <sup>2</sup> C controller state. If set, the controller is idle; otherwise the controller is not idle.  |

| Bit/Field | Name    | Type | Reset | Description   |
|-----------|---------|------|-------|---|
| 4         | ARBLST  | R    | 0     | This bit specifies the result of bus arbitration. If set, the controller lost arbitration; otherwise, the controller won arbitration.   |
| 3         | DATAACK | R    | 0     | This bit specifies the result of the last data operation. If set, the transmitted data was not acknowledged; otherwise, the data was acknowledged.  |
| 2         | ADRACK  | R    | 0     | This bit specifies the result of the last address operation. If set, the transmitted address was not acknowledged; otherwise, the address was acknowledged.   |
| 1         | ERROR   | R    | 0     | This bit specifies the result of the last bus operation. If set, an error occurred on the last operation; otherwise, no error was detected. The error can be from the slave address not being acknowledged, the transmit data not being acknowledged, or because the controller lost arbitration. |
| 0         | BUSY    | R    | 0     | This bit specifies the state of the controller. If set, the controller is busy; otherwise, the controller is idle. When the <code>BUSY</code> bit is set, the other status bits are not valid.  |

#### Write-Only Control Register

|      |          |    |   |   |
|------|----------|----|---|---|
| 31:7 | reserved | RO | 0 | Reserved bits return an indeterminate value, and should never be changed.   |
| 6-4  | reserved | W  | 0 | Write reserved.   |
| 3    | ACK      | W  | 0 | When set, causes received data byte to be acknowledged automatically by the master. See field decoding in Table 14-3 on page 310. |
| 2    | STOP     | W  | 0 | When set, causes the generation of the STOP condition. See field decoding in Table 14-3.  |
| 1    | START    | W  | 0 | When set, causes the generation of a START or repeated START condition. See field decoding in Table 14-3.                         |
| 0    | RUN      | W  | 0 | When set, allows the master to send or receive data. See field decoding in Table 14-3.  |

Table 14-3. Write Field Decoding for I2CMCS[3:0] Field (Sheet 1 of 3)

| Current State | I2CMSA[0]   | I2CMCS[3:0]    |      |       |     | Description  |
|---------------|---|----------------|------|-------|-----|--|
|               | R/S   | ACK            | STOP | START | RUN |  |
| Idle          | 0   | X <sup>a</sup> | 0    | 1     | 1   | START condition followed by SEND (master goes to the Master Transmit state).                               |
|               | 0   | X              | 1    | 1     | 1   | START condition followed by a SEND and STOP condition (master remains in Idle state).                      |
|               | 1   | 0              | 0    | 1     | 1   | START condition followed by RECEIVE operation with negative ACK (master goes to the Master Receive state). |
|               | 1   | 0              | 1    | 1     | 1   | START condition followed by RECEIVE and STOP condition (master remains in Idle state).                     |
|               | 1   | 1              | 0    | 1     | 1   | START condition followed by RECEIVE (master goes to the Master Receive state).                             |
|               | 1   | 1              | 1    | 1     | 1   | Illegal.   |
|               | All other combinations not listed are non-operations. |                |      |       |     | NOP.   |

Table 14-3. Write Field Decoding for I2CMCS[3:0] Field (Sheet 2 of 3)

| Current State   | I2CMSA[0]   | I2CMCS[3:0] |      |       |     | Description   |
|-----------------|---|-------------|------|-------|-----|---|
|                 | R/S   | ACK         | STOP | START | RUN |   |
| Master Transmit | X   | X           | 0    | 0     | 1   | SEND operation (master remains in Master Transmit state).   |
|                 | X   | X           | 1    | 0     | 0   | STOP condition (master goes to Idle state).   |
|                 | X   | X           | 1    | 0     | 1   | SEND followed by STOP condition (master goes to Idle state).  |
|                 | 0   | X           | 0    | 1     | 1   | Repeated START condition followed by a SEND (master remains in Master Transmit state).                              |
|                 | 0   | X           | 1    | 1     | 1   | Repeated START condition followed by SEND and STOP condition (master goes to Idle state).                           |
|                 | 1   | 0           | 0    | 1     | 1   | Repeated START condition followed by a RECEIVE operation with a negative ACK (master goes to Master Receive state). |
|                 | 1   | 0           | 1    | 1     | 1   | Repeated START condition followed by a SEND and STOP condition (master goes to Idle state).                         |
|                 | 1   | 1           | 0    | 1     | 1   | Repeated START condition followed by RECEIVE (master goes to Master Receive state).                                 |
|                 | 1   | 1           | 1    | 1     | 1   | Illegal.  |
|                 | All other combinations not listed are non-operations. |             |      |       |     | NOP.  |

Table 14-3. Write Field Decoding for I2CMCS[3:0] Field (Sheet 3 of 3)

| Current State  | I2CMSA[0]   | I2CMCS[3:0] |      |       |     | Description  |
|----------------|---|-------------|------|-------|-----|--|
|                | R/S   | ACK         | STOP | START | RUN |  |
| Master Receive | X   | 0           | 0    | 0     | 1   | RECEIVE operation with negative ACK (master remains in Master Receive state).  |
|                | X   | X           | 1    | 0     | 0   | STOP condition (master goes to Idle state). <sup>b</sup>   |
|                | X   | 0           | 1    | 0     | 1   | RECEIVE followed by STOP condition (master goes to Idle state).  |
|                | X   | 1           | 0    | 0     | 1   | RECEIVE operation (master remains in Master Receive state).  |
|                | X   | 1           | 1    | 0     | 1   | Illegal.   |
|                | 1   | 0           | 0    | 1     | 1   | Repeated START condition followed by RECEIVE operation with a negative ACK (master remains in Master Receive state). |
|                | 1   | 0           | 1    | 1     | 1   | Repeated START condition followed by RECEIVE and STOP condition (master goes to Idle state).                         |
|                | 1   | 1           | 0    | 1     | 1   | Repeated START condition followed by RECEIVE (master remains in Master Receive state).                               |
|                | 0   | X           | 0    | 1     | 1   | Repeated START condition followed by SEND (master goes to Master Transmit state).                                    |
|                | 0   | X           | 1    | 1     | 1   | Repeated START condition followed by SEND and STOP condition (master goes to Idle state).                            |
|                | All other combinations not listed are non-operations. |             |      |       |     | NOP.   |

a. An X in a table cell indicates that applies to a bit set to 0 or 1.

b. In Master Receive mode, a STOP condition should be generated only after a Data Negative Acknowledge executed by the master or an Address Negative Acknowledge executed by the slave.



**Register 3: I<sup>2</sup>C Master Data (I2CMDR), offset 0x008**

This register contains the data to be transmitted when in the Master Transmit state, and the data received when in the Master Receive state.

## I2C Master Data (I2CMDR)

Offset 0x008

|       | 31       | 30 | 29 | 28 | 27 | 26 | 25 | 24 | 23   | 22  | 21  | 20  | 19  | 18  | 17  | 16  |
|-------|----------|----|----|----|----|----|----|----|------|-----|-----|-----|-----|-----|-----|-----|
|       | reserved |    |    |    |    |    |    |    |      |     |     |     |     |     |     |     |
| Type  | RO       | RO | RO | RO | RO | RO | RO | RO | RO   | RO  | RO  | RO  | RO  | RO  | RO  | RO  |
| Reset | 0        | 0  | 0  | 0  | 0  | 0  | 0  | 0  | 0    | 0   | 0   | 0   | 0   | 0   | 0   | 0   |
|       | 15       | 14 | 13 | 12 | 11 | 10 | 9  | 8  | 7    | 6   | 5   | 4   | 3   | 2   | 1   | 0   |
|       | reserved |    |    |    |    |    |    |    | DATA |     |     |     |     |     |     |     |
| Type  | RO       | RO | RO | RO | RO | RO | RO | RO | R/W  | R/W | R/W | R/W | R/W | R/W | R/W | R/W |
| Reset | 0        | 0  | 0  | 0  | 0  | 0  | 0  | 0  | 0    | 0   | 0   | 0   | 0   | 0   | 0   | 0   |

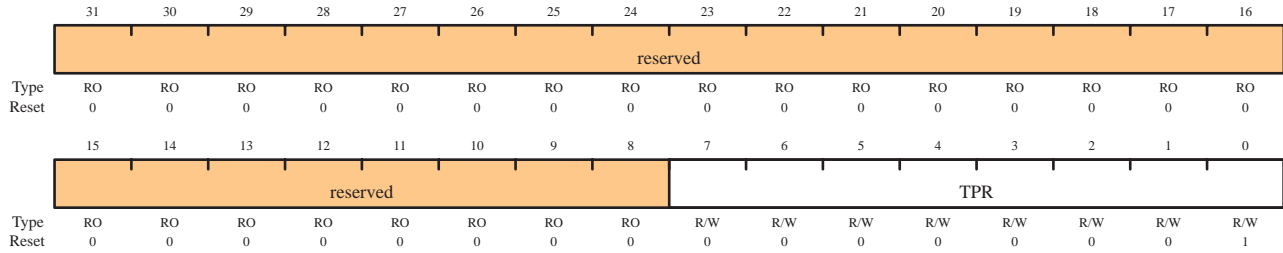
| Bit/Field | Name     | Type | Reset | Description   |
|-----------|----------|------|-------|---|
| 31:8      | reserved | RO   | 0     | Reserved bits return an indeterminate value, and should never be changed. |
| 7:0       | DATA     | R/W  | 0x00  | Data transferred during transaction.                                      |

**Register 4: I<sup>2</sup>C Master Timer Period (I2CMTPR), offset 0x00C**

This register specifies the period of the SCL clock

I2C Master Timer Period (I2CMTPR)

Offset 0x00C



| Bit/Field | Name     | Type | Reset | Description  |
|-----------|----------|------|-------|--|
| 31:8      | reserved | RO   | 0     | Reserved bits return an indeterminate value, and should never be changed.  |
| 7:0       | TPR      | R/W  | 0x1   | <p>This field specifies the period of the SCL clock.</p> $SCL\_PRD = 2 * (1 + TPR) * (SCL\_LP + SCL\_HP) * CLK\_PRD$ <p>where:</p> <p>SCL_PRD is the SCL line period (I<sup>2</sup>C clock).</p> <p>TPR is the Timer Period register value (range of 1 to 255).</p> <p>SCL_LP is the SCL Low period (fixed at 6).</p> <p>SCL_HP is the SCL High period (fixed at 4).</p> |

**Register 5: I<sup>2</sup>C Master Interrupt Mask (I2CMIMR), offset 0x010**

This register controls whether a raw interrupt is promoted to a controller interrupt.

**I2C Master Interrupt Mask (I2CMIMR)**

Offset 0x010

|       |          |    |    |    |    |    |    |    |    |    |    |    |    |    |    |     |
|-------|----------|----|----|----|----|----|----|----|----|----|----|----|----|----|----|-----|
|       | 31       | 30 | 29 | 28 | 27 | 26 | 25 | 24 | 23 | 22 | 21 | 20 | 19 | 18 | 17 | 16  |
|       | reserved |    |    |    |    |    |    |    |    |    |    |    |    |    |    |     |
| Type  | RO       | RO | RO | RO | RO | RO | RO | RO | RO | RO | RO | RO | RO | RO | RO | RO  |
| Reset | 0        | 0  | 0  | 0  | 0  | 0  | 0  | 0  | 0  | 0  | 0  | 0  | 0  | 0  | 0  | 0   |
|       | 15       | 14 | 13 | 12 | 11 | 10 | 9  | 8  | 7  | 6  | 5  | 4  | 3  | 2  | 1  | 0   |
|       | reserved |    |    |    |    |    |    |    |    |    |    |    |    |    |    | IM  |
| Type  | RO       | RO | RO | RO | RO | RO | RO | RO | RO | RO | RO | RO | RO | RO | RO | R/W |
| Reset | 0        | 0  | 0  | 0  | 0  | 0  | 0  | 0  | 0  | 0  | 0  | 0  | 0  | 0  | 0  | 0   |

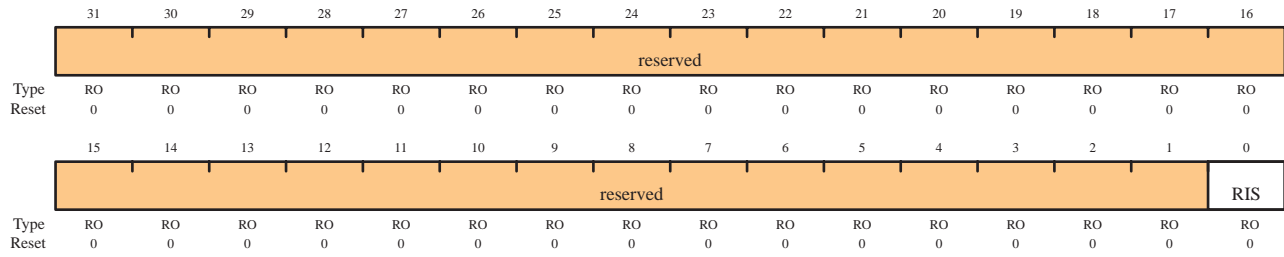
| Bit/Field | Name     | Type | Reset | Description   |
|-----------|----------|------|-------|---|
| 31:1      | reserved | RO   | 0     | Reserved bits return an indeterminate value, and should never be changed.   |
| 0         | IM       | R/W  | 0     | This bit controls whether a raw interrupt is promoted to a controller interrupt. If set, the interrupt is not masked and the interrupt is promoted; otherwise, the interrupt is masked. |

**Register 6: I<sup>2</sup>C Master Raw Interrupt Status (I2CMRIS), offset 0x014**

This register specifies whether an interrupt is pending.

I2C Master Raw Interrupt Status (I2CMRIS)

Offset 0x014



| Bit/Field | Name     | Type | Reset | Description  |
|-----------|----------|------|-------|--|
| 31:1      | reserved | RO   | 0     | Reserved bits return an indeterminate value, and should never be changed.  |
| 0         | RIS      | RO   | 0     | This bit specifies the raw interrupt state (prior to masking) of the I <sup>2</sup> C master block. If set, an interrupt is pending; otherwise, an interrupt is not pending. |

**Register 7: I<sup>2</sup>C Master Masked Interrupt Status (I2CMMIS), offset 0x018**

This register specifies whether an interrupt was signaled.

## I2C Master Masked Interrupt Status (I2CMMIS)

Offset 0x018

|       |          |    |    |    |    |    |    |    |    |    |    |    |    |    |    |     |
|-------|----------|----|----|----|----|----|----|----|----|----|----|----|----|----|----|-----|
|       | 31       | 30 | 29 | 28 | 27 | 26 | 25 | 24 | 23 | 22 | 21 | 20 | 19 | 18 | 17 | 16  |
|       | reserved |    |    |    |    |    |    |    |    |    |    |    |    |    |    |     |
| Type  | RO       | RO | RO | RO | RO | RO | RO | RO | RO | RO | RO | RO | RO | RO | RO | RO  |
| Reset | 0        | 0  | 0  | 0  | 0  | 0  | 0  | 0  | 0  | 0  | 0  | 0  | 0  | 0  | 0  | 0   |
|       | 15       | 14 | 13 | 12 | 11 | 10 | 9  | 8  | 7  | 6  | 5  | 4  | 3  | 2  | 1  | 0   |
|       | reserved |    |    |    |    |    |    |    |    |    |    |    |    |    |    | MIS |
| Type  | RO       | RO | RO | RO | RO | RO | RO | RO | RO | RO | RO | RO | RO | RO | RO | RO  |
| Reset | 0        | 0  | 0  | 0  | 0  | 0  | 0  | 0  | 0  | 0  | 0  | 0  | 0  | 0  | 0  | 0   |

| Bit/Field | Name     | Type | Reset | Description  |
|-----------|----------|------|-------|--|
| 31:1      | reserved | RO   | 0     | Reserved bits return an indeterminate value, and should never be changed.  |
| 0         | MIS      | RO   | 0     | This bit specifies the raw interrupt state (after masking) of the I <sup>2</sup> C master block. If set, an interrupt was signaled; otherwise, an interrupt has not been generated since the bit was last cleared. |

**Register 8: I<sup>2</sup>C Master Interrupt Clear (I2CMICR), offset 0x01C**

This register clears the raw interrupt.

I2C Master Interrupt Clear (I2CMICR)

Offset 0x01C

|       |          |    |    |    |    |    |    |    |    |    |    |    |    |    |    |    |
|-------|----------|----|----|----|----|----|----|----|----|----|----|----|----|----|----|----|
|       | 31       | 30 | 29 | 28 | 27 | 26 | 25 | 24 | 23 | 22 | 21 | 20 | 19 | 18 | 17 | 16 |
|       | reserved |    |    |    |    |    |    |    |    |    |    |    |    |    |    |    |
| Type  | RO       | RO | RO | RO | RO | RO | RO | RO | RO | RO | RO | RO | RO | RO | RO | RO |
| Reset | 0        | 0  | 0  | 0  | 0  | 0  | 0  | 0  | 0  | 0  | 0  | 0  | 0  | 0  | 0  | 0  |
|       | 15       | 14 | 13 | 12 | 11 | 10 | 9  | 8  | 7  | 6  | 5  | 4  | 3  | 2  | 1  | 0  |
|       | reserved |    |    |    |    |    |    |    |    |    |    |    |    |    |    | IC |
| Type  | RO       | RO | RO | RO | RO | RO | RO | RO | RO | RO | RO | RO | RO | RO | RO | WO |
| Reset | 0        | 0  | 0  | 0  | 0  | 0  | 0  | 0  | 0  | 0  | 0  | 0  | 0  | 0  | 0  | 0  |

| Bit/Field | Name     | Type | Reset | Description  |
|-----------|----------|------|-------|--|
| 31:1      | reserved | RO   | 0     | Reserved bits return an indeterminate value, and should never be changed.  |
| 0         | IC       | WO   | 0     | Interrupt Clear<br>This bit controls the clearing of the raw interrupt. A write of 1 clears the interrupt; otherwise, a write of 0 has no affect on the interrupt state. A read of this register returns no meaningful data. |

**Register 9: I<sup>2</sup>C Master Configuration (I2CMCR), offset 0x020**

This register configures the mode (Master or Slave) and sets the interface for test mode loopback.

## I2C Master Configuration (I2CMCR)

Offset 0x020

|       |          |    |    |    |    |    |    |    |    |    |    |     |     |          |    |      |     |
|-------|----------|----|----|----|----|----|----|----|----|----|----|-----|-----|----------|----|------|-----|
|       | 31       | 30 | 29 | 28 | 27 | 26 | 25 | 24 | 23 | 22 | 21 | 20  | 19  | 18       | 17 | 16   |     |
|       | reserved |    |    |    |    |    |    |    |    |    |    |     |     |          |    |      |     |
| Type  | RO       | RO | RO | RO | RO | RO | RO | RO | RO | RO | RO | RO  | RO  | RO       | RO | RO   |     |
| Reset | 0        | 0  | 0  | 0  | 0  | 0  | 0  | 0  | 0  | 0  | 0  | 0   | 0   | 0        | 0  | 0    |     |
|       | 15       | 14 | 13 | 12 | 11 | 10 | 9  | 8  | 7  | 6  | 5  | 4   | 3   | 2        | 1  | 0    |     |
|       | reserved |    |    |    |    |    |    |    |    |    |    | SFE | MFE | reserved |    | LPBK |     |
| Type  | RO       | RO | RO | RO | RO | RO | RO | RO | RO | RO | RO | R/W | R/W | RO       | RO | RO   | R/W |
| Reset | 0        | 0  | 0  | 0  | 0  | 0  | 0  | 0  | 0  | 0  | 0  | 0   | 0   | 0        | 0  | 0    | 0   |

| Bit/Field | Name     | Type | Reset | Description  |
|-----------|----------|------|-------|--|
| 31:6      | reserved | RO   | 0     | Reserved bits return an indeterminate value, and should never be changed.  |
| 5         | SFE      | R/W  | 0     | I <sup>2</sup> C Slave Function Enable<br><br>This bit specifies whether the interface may operate in Slave mode. If set, Slave mode is enabled; otherwise, Slave mode is disabled.  |
| 4         | MFE      | R/W  | 0     | I <sup>2</sup> C Master Function Enable<br><br>This bit specifies whether the interface may operate in Master mode. If set, Master mode is enabled; otherwise, Master mode is disabled and the interface clock is disabled.    |
| 3:1       | reserved | RO   | 0     | Reserved bits return an indeterminate value, and should never be changed.  |
| 0         | LPBK     | R/W  | 0     | I <sup>2</sup> C Loopback<br><br>This bit specifies whether the interface is operating normally or in Loopback mode. If set, the device is put in a test mode loopback configuration; otherwise, the device operates normally. |

## 14.6 Register Descriptions (I<sup>2</sup>C Slave)

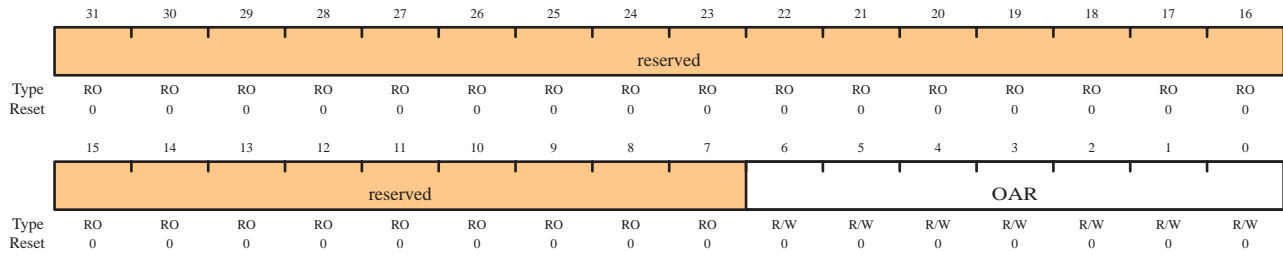
The remainder of this section lists and describes the I<sup>2</sup>C slave registers, in numerical order by address offset. See also “Register Descriptions (I2C Master)” on page 306.

### Register 10: I<sup>2</sup>C Slave Own Address (I2CSOAR), offset 0x000

This register consists of seven address bits that identify the Stellaris I<sup>2</sup>C device on the I<sup>2</sup>C bus.

I2C Slave Own Address Register (I2CSOAR)

Offset 0x000



| Bit/Field | Name     | Type | Reset | Description   |
|-----------|----------|------|-------|---|
| 31:7      | reserved | RO   | 0     | Reserved bits return an indeterminate value, and should never be changed.                           |
| 6:0       | OAR      | R/W  | 0     | I <sup>2</sup> C Slave Own Address<br>This field specifies bits A6 through A0 of the slave address. |



**Register 11: I<sup>2</sup>C Slave Control/Status (I2CSCSR), offset 0x004**

This register accesses one control bit when written, and two status bits when read.

The read-only Status register consists of two bits: the RREQ bit and the TREQ bit. The Receive Request (RREQ) bit indicates that the Stellaris I<sup>2</sup>C device has received a data byte from an I<sup>2</sup>C master. Read one data byte from the **I2C Slave Data (I2CSDR)** register. The Transmit Request (TREQ) bit indicates that the Stellaris I<sup>2</sup>C device is addressed as a Slave Transmitter. Write one data byte into the **I2C Slave Data (I2CSDR)** register.

The write-only Control register consists of one bit: the DA bit. The DA bit enables and disables the Stellaris I<sup>2</sup>C slave operation.

**I2C Slave Status Register (I2CSCSR): Read**

Offset 0x004

|       |          |    |    |    |    |    |    |    |    |    |    |    |    |    |      |      |
|-------|----------|----|----|----|----|----|----|----|----|----|----|----|----|----|------|------|
|       | 31       | 30 | 29 | 28 | 27 | 26 | 25 | 24 | 23 | 22 | 21 | 20 | 19 | 18 | 17   | 16   |
|       | reserved |    |    |    |    |    |    |    |    |    |    |    |    |    |      |      |
| Type  | RO       | RO | RO | RO | RO | RO | RO | RO | RO | RO | RO | RO | RO | RO | RO   | RO   |
| Reset | 0        | 0  | 0  | 0  | 0  | 0  | 0  | 0  | 0  | 0  | 0  | 0  | 0  | 0  | 0    | 0    |
|       | 15       | 14 | 13 | 12 | 11 | 10 | 9  | 8  | 7  | 6  | 5  | 4  | 3  | 2  | 1    | 0    |
|       | reserved |    |    |    |    |    |    |    |    |    |    |    |    |    | TREQ | RREQ |
| Type  | RO       | RO | RO | RO | RO | RO | RO | RO | RO | RO | RO | RO | RO | RO | RO   | RO   |
| Reset | 0        | 0  | 0  | 0  | 0  | 0  | 0  | 0  | 0  | 0  | 0  | 0  | 0  | 0  | 0    | 0    |

**I2C Slave Control Register (I2CSCSR): Write**

Offset 0x004

|       |          |    |    |    |    |    |    |    |    |    |    |    |    |    |    |    |
|-------|----------|----|----|----|----|----|----|----|----|----|----|----|----|----|----|----|
|       | 31       | 30 | 29 | 28 | 27 | 26 | 25 | 24 | 23 | 22 | 21 | 20 | 19 | 18 | 17 | 16 |
|       | reserved |    |    |    |    |    |    |    |    |    |    |    |    |    |    |    |
| Type  | RO       | RO | RO | RO | RO | RO | RO | RO | RO | RO | RO | RO | RO | RO | RO | RO |
| Reset | 0        | 0  | 0  | 0  | 0  | 0  | 0  | 0  | 0  | 0  | 0  | 0  | 0  | 0  | 0  | 0  |
|       | 15       | 14 | 13 | 12 | 11 | 10 | 9  | 8  | 7  | 6  | 5  | 4  | 3  | 2  | 1  | 0  |
|       | reserved |    |    |    |    |    |    |    |    |    |    |    |    |    |    | DA |
| Type  | RO       | RO | RO | RO | RO | RO | RO | RO | RO | RO | RO | RO | RO | RO | RO | RO |
| Reset | 0        | 0  | 0  | 0  | 0  | 0  | 0  | 0  | 0  | 0  | 0  | 0  | 0  | 0  | 0  | 0  |

| Bit/Field | Name | Type | Reset | Description |
|-----------|------|------|-------|-------------|
|-----------|------|------|-------|-------------|

**Read-Only Status Register**

|      |          |    |   |   |
|------|----------|----|---|---|
| 31:2 | reserved | RO | 0 | Reserved bits return an indeterminate value, and should never be changed.   |
| 1    | TREQ     | RO | 0 | This bit specifies the state of the I <sup>2</sup> C slave with regards to outstanding transmit requests. If set, the I <sup>2</sup> C unit has been addressed as a slave transmitter and uses clock stretching to delay the master until data has been written to the <b>I2CSDR</b> register. Otherwise, there is no outstanding transmit request. |

## Inter-Integrated Circuit (I2C) Interface

---

| Bit/Field | Name | Type | Reset | Description   |
|-----------|------|------|-------|---|
| 0         | RREQ | RO   | 0     | Receive Request<br><br>This bit specifies the status of the I <sup>2</sup> C slave with regards to outstanding receive requests. If set, the I <sup>2</sup> C unit has outstanding receive data from the I <sup>2</sup> C master and uses clock stretching to delay the master until the data has been read from the <b>I2CSDR</b> register. Otherwise, no receive data is outstanding. |

### Write-Only Control Register

|      |          |    |   |  |
|------|----------|----|---|--|
| 31:1 | reserved | RO | 0 | Reserved bits return an indeterminate value, and should never be changed.  |
| 0    | DA       | WO | 0 | Device Active<br>1=Enables the I <sup>2</sup> C slave operation.<br>0=Disables the I <sup>2</sup> C slave operation. |

**Register 12: I<sup>2</sup>C Slave Data (I2CSDR), offset 0x008**

This register contains the data to be transmitted when in the Slave Transmit state, and the data received when in the Slave Receive state.

I<sup>2</sup>C Slave Data (I2CSDR)

Offset 0x008

|       | 31       | 30 | 29 | 28 | 27 | 26 | 25 | 24 | 23   | 22  | 21  | 20  | 19  | 18  | 17  | 16  |
|-------|----------|----|----|----|----|----|----|----|------|-----|-----|-----|-----|-----|-----|-----|
|       | reserved |    |    |    |    |    |    |    |      |     |     |     |     |     |     |     |
| Type  | RO       | RO | RO | RO | RO | RO | RO | RO | RO   | RO  | RO  | RO  | RO  | RO  | RO  | RO  |
| Reset | 0        | 0  | 0  | 0  | 0  | 0  | 0  | 0  | 0    | 0   | 0   | 0   | 0   | 0   | 0   | 0   |
|       | 15       | 14 | 13 | 12 | 11 | 10 | 9  | 8  | 7    | 6   | 5   | 4   | 3   | 2   | 1   | 0   |
|       | reserved |    |    |    |    |    |    |    | DATA |     |     |     |     |     |     |     |
| Type  | RO       | RO | RO | RO | RO | RO | RO | RO | R/W  | R/W | R/W | R/W | R/W | R/W | R/W | R/W |
| Reset | 0        | 0  | 0  | 0  | 0  | 0  | 0  | 0  | 0    | 0   | 0   | 0   | 0   | 0   | 0   | 0   |

| Bit/Field | Name     | Type | Reset | Description   |
|-----------|----------|------|-------|---|
| 31:8      | reserved | RO   | 0     | Reserved bits return an indeterminate value, and should never be changed.               |
| 7:0       | DATA     | R/W  | 0x0   | This field contains the data for transfer during a slave receive or transmit operation. |

**Register 13: I<sup>2</sup>C Slave Interrupt Mask (I2CSIMR), offset 0x00C**

This register controls whether a raw interrupt is promoted to a controller interrupt.

I2C Slave Interrupt Mask (I2CSIMR)

Offset 0x00C

|       |          |    |    |    |    |    |    |    |    |    |    |    |    |    |    |     |
|-------|----------|----|----|----|----|----|----|----|----|----|----|----|----|----|----|-----|
|       | 31       | 30 | 29 | 28 | 27 | 26 | 25 | 24 | 23 | 22 | 21 | 20 | 19 | 18 | 17 | 16  |
|       | reserved |    |    |    |    |    |    |    |    |    |    |    |    |    |    |     |
| Type  | RO       | RO | RO | RO | RO | RO | RO | RO | RO | RO | RO | RO | RO | RO | RO | RO  |
| Reset | 0        | 0  | 0  | 0  | 0  | 0  | 0  | 0  | 0  | 0  | 0  | 0  | 0  | 0  | 0  | 0   |
|       | 15       | 14 | 13 | 12 | 11 | 10 | 9  | 8  | 7  | 6  | 5  | 4  | 3  | 2  | 1  | 0   |
|       | reserved |    |    |    |    |    |    |    |    |    |    |    |    |    |    | IM  |
| Type  | RO       | RO | RO | RO | RO | RO | RO | RO | RO | RO | RO | RO | RO | RO | RO | R/W |
| Reset | 0        | 0  | 0  | 0  | 0  | 0  | 0  | 0  | 0  | 0  | 0  | 0  | 0  | 0  | 0  | 0   |

| Bit/Field | Name     | Type | Reset | Description   |
|-----------|----------|------|-------|---|
| 31:1      | reserved | RO   | 0     | Reserved bits return an indeterminate value, and should never be changed.   |
| 0         | IM       | R/W  | 0     | This bit controls whether a raw interrupt is promoted to a controller interrupt. If set, the interrupt is not masked and the interrupt is promoted; otherwise, the interrupt is masked. |

**Register 14: I<sup>2</sup>C Slave Raw Interrupt Status (I2CSRIS), offset 0x010**

This register specifies whether an interrupt is pending.

I<sup>2</sup>C Slave Raw Interrupt Status (I2CSRIS)

Offset 0x010

|       |          |    |    |    |    |    |    |    |    |    |    |    |    |    |    |     |
|-------|----------|----|----|----|----|----|----|----|----|----|----|----|----|----|----|-----|
|       | 31       | 30 | 29 | 28 | 27 | 26 | 25 | 24 | 23 | 22 | 21 | 20 | 19 | 18 | 17 | 16  |
|       | reserved |    |    |    |    |    |    |    |    |    |    |    |    |    |    |     |
| Type  | RO       | RO | RO | RO | RO | RO | RO | RO | RO | RO | RO | RO | RO | RO | RO | RO  |
| Reset | 0        | 0  | 0  | 0  | 0  | 0  | 0  | 0  | 0  | 0  | 0  | 0  | 0  | 0  | 0  | 0   |
|       | 15       | 14 | 13 | 12 | 11 | 10 | 9  | 8  | 7  | 6  | 5  | 4  | 3  | 2  | 1  | 0   |
|       | reserved |    |    |    |    |    |    |    |    |    |    |    |    |    |    | RIS |
| Type  | RO       | RO | RO | RO | RO | RO | RO | RO | RO | RO | RO | RO | RO | RO | RO | RO  |
| Reset | 0        | 0  | 0  | 0  | 0  | 0  | 0  | 0  | 0  | 0  | 0  | 0  | 0  | 0  | 0  | 0   |

| Bit/Field | Name     | Type | Reset | Description   |
|-----------|----------|------|-------|---|
| 31:1      | reserved | RO   | 0     | Reserved bits return an indeterminate value, and should never be changed.   |
| 0         | RIS      | RO   | 0     | This bit specifies the raw interrupt state (prior to masking) of the I <sup>2</sup> C slave block. If set, an interrupt is pending; otherwise, an interrupt is not pending. |

**Register 15: I<sup>2</sup>C Slave Masked Interrupt Status (I2CSMIS), offset 0x014**

This register specifies whether an interrupt was signaled.

I2C Slave Masked Interrupt Status (I2CSMIS)

Offset 0x014

|       |          |    |    |    |    |    |    |    |    |    |    |    |    |    |    |     |
|-------|----------|----|----|----|----|----|----|----|----|----|----|----|----|----|----|-----|
|       | 31       | 30 | 29 | 28 | 27 | 26 | 25 | 24 | 23 | 22 | 21 | 20 | 19 | 18 | 17 | 16  |
|       | reserved |    |    |    |    |    |    |    |    |    |    |    |    |    |    |     |
| Type  | RO       | RO | RO | RO | RO | RO | RO | RO | RO | RO | RO | RO | RO | RO | RO | RO  |
| Reset | 0        | 0  | 0  | 0  | 0  | 0  | 0  | 0  | 0  | 0  | 0  | 0  | 0  | 0  | 0  | 0   |
|       | 15       | 14 | 13 | 12 | 11 | 10 | 9  | 8  | 7  | 6  | 5  | 4  | 3  | 2  | 1  | 0   |
|       | reserved |    |    |    |    |    |    |    |    |    |    |    |    |    |    | MIS |
| Type  | RO       | RO | RO | RO | RO | RO | RO | RO | RO | RO | RO | RO | RO | RO | RO | RO  |
| Reset | 0        | 0  | 0  | 0  | 0  | 0  | 0  | 0  | 0  | 0  | 0  | 0  | 0  | 0  | 0  | 0   |

| Bit/Field | Name     | Type | Reset | Description   |
|-----------|----------|------|-------|---|
| 31:1      | reserved | RO   | 0     | Reserved bits return an indeterminate value, and should never be changed.   |
| 0         | MIS      | RO   | 0     | This bit specifies the raw interrupt state (after masking) of the I <sup>2</sup> C slave block. If set, an interrupt was signaled; otherwise, an interrupt has not been generated since the bit was last cleared. |

**Register 16: I<sup>2</sup>C Slave Interrupt Clear (I2CSICR), offset 0x018**

This register clears the raw interrupt.

**I2C Slave Interrupt Clear (I2CSICR)**

Offset 0x018

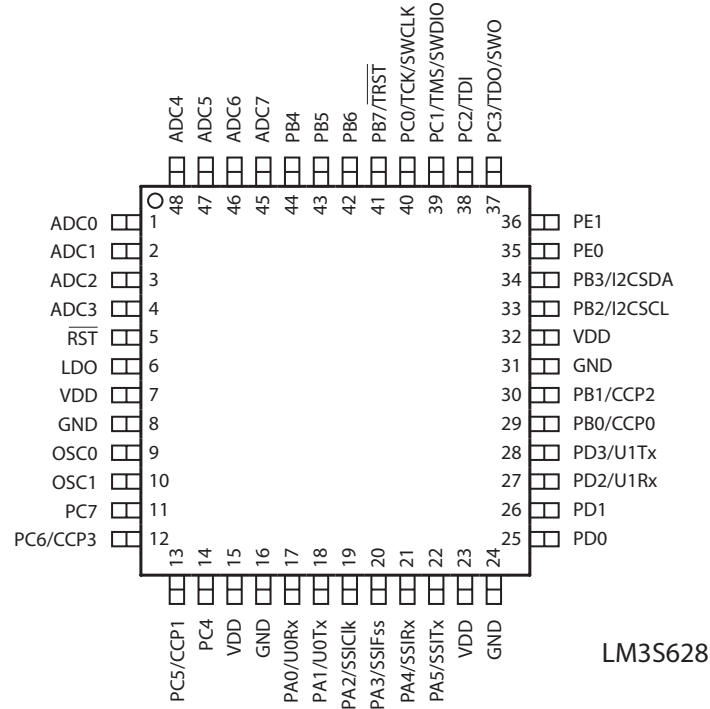
|       |          |    |    |    |    |    |    |    |    |    |    |    |    |    |    |    |    |
|-------|----------|----|----|----|----|----|----|----|----|----|----|----|----|----|----|----|----|
|       | 31       | 30 | 29 | 28 | 27 | 26 | 25 | 24 | 23 | 22 | 21 | 20 | 19 | 18 | 17 | 16 |    |
|       | reserved |    |    |    |    |    |    |    |    |    |    |    |    |    |    |    |    |
| Type  | RO       | RO | RO | RO | RO | RO | RO | RO | RO | RO | RO | RO | RO | RO | RO | RO |    |
| Reset | 0        | 0  | 0  | 0  | 0  | 0  | 0  | 0  | 0  | 0  | 0  | 0  | 0  | 0  | 0  | 0  |    |
|       | 15       | 14 | 13 | 12 | 11 | 10 | 9  | 8  | 7  | 6  | 5  | 4  | 3  | 2  | 1  | 0  |    |
|       | reserved |    |    |    |    |    |    |    |    |    |    |    |    |    |    | IC |    |
| Type  | RO       | RO | RO | RO | RO | RO | RO | RO | RO | RO | RO | RO | RO | RO | RO | RO | WO |
| Reset | 0        | 0  | 0  | 0  | 0  | 0  | 0  | 0  | 0  | 0  | 0  | 0  | 0  | 0  | 0  | 0  | 0  |

| Bit/Field | Name     | Type | Reset | Description  |
|-----------|----------|------|-------|--|
| 31:1      | reserved | RO   | 0     | Reserved bits return an indeterminate value, and should never be changed.  |
| 0         | IC       | WO   | 0     | This bit controls the clearing of the raw interrupt. A write of 1 clears the interrupt; otherwise a write of 0 has no affect on the interrupt state. A read of this register returns no meaningful data. |

# 15 Pin Diagram

Figure 15-1 shows the pin diagram and pin-to-signal-name mapping.

**Figure 15-1. Pin Connection Diagram**





## 16 Signal Tables

The following tables list the signals available for each pin. Functionality is enabled by software with the **GPIOAFSEL** register (see page 119).

**Important:** All multiplexed pins are GPIOs by default, with the exception of the five JTAG pins (PB7 and PC[3:0]) which default to the JTAG functionality.

Table 16-1 shows the pin-to-signal-name mapping, including functional characteristics of the signals. Table 16-2 lists the signals in alphabetical order by signal name. Table 16-3 groups the signals by functionality, except for GPIOs. Table 16-4 lists the GPIO pins and their alternate functionality.

**Table 16-1. Signals by Pin Number (Sheet 1 of 3)**

| Pin Number | Pin Name                | Pin Type | Buffer Type | Description   |
|------------|-------------------------|----------|-------------|---|
| 1          | ADC0                    | I        | Analog      | Analog-to-digital converter input 0.  |
| 2          | ADC1                    | I        | Analog      | Analog-to-digital converter input 1.  |
| 3          | ADC2                    | I        | Analog      | Analog-to-digital converter input 2.  |
| 4          | ADC3                    | I        | Analog      | Analog-to-digital converter input 3.  |
| 5          | $\overline{\text{RST}}$ | I        | TTL         | System reset input.   |
| 6          | LDO                     | -        | Power       | The low drop-out regulator output voltage. This pin requires an external capacitor between the pin and GND of 1 $\mu\text{F}$ or greater. |
| 7          | VDD                     | -        | Power       | Positive supply for logic and I/O pins.   |
| 8          | GND                     | -        | Power       | Ground reference for logic and I/O pins.  |
| 9          | OSC0                    | I        | Analog      | Oscillator crystal input or an external clock reference input.  |
| 10         | OSC1                    | O        | Analog      | Oscillator crystal output.  |
| 11         | PC7                     | I/O      | TTL         | GPIO port C bit 7.  |
| 12         | PC6                     | I/O      | TTL         | GPIO port C bit 6.  |
|            | CCP3                    | I/O      | TTL         | Timer 1 capture input, compare output, or PWM output channel 3.   |
| 13         | PC5                     | I/O      | TTL         | GPIO port C bit 5.  |
|            | CCP1                    | I/O      | TTL         | Timer 0 capture input, compare output, or PWM output channel 1.   |
| 14         | PC4                     | I/O      | TTL         | GPIO port C bit 4.  |
| 15         | VDD                     | -        | Power       | Positive supply for logic and I/O pins.   |
| 16         | GND                     | -        | Power       | Ground reference for logic and I/O pins.  |
| 17         | PA0                     | I/O      | TTL         | GPIO port A bit 0.  |
|            | U0Rx                    | I        | TTL         | UART0 receive data input.   |

Table 16-1. Signals by Pin Number (Sheet 2 of 3)

| Pin Number | Pin Name | Pin Type | Buffer Type | Description   |
|------------|----------|----------|-------------|---|
| 18         | PA1      | I/O      | TTL         | GPIO port A bit 1.  |
|            | U0Tx     | O        | TTL         | UART0 transmit data output.   |
| 19         | PA2      | I/O      | TTL         | GPIO port A bit 2.  |
|            | SSIClk   | I/O      | TTL         | SSI clock reference (input when in slave mode and output in master mode).             |
| 20         | PA3      | I/O      | TTL         | GPIO port A bit 3.  |
|            | SSIFss   | I/O      | TTL         | SSI frame enable (input for an SSI slave device and output for an SSI master device). |
| 21         | PA4      | I/O      | TTL         | GPIO port A bit 4.  |
|            | SSIRx    | I        | TTL         | SSI receive data input.   |
| 22         | PA5      | I/O      | TTL         | GPIO port A bit 5.  |
|            | SSITx    | O        | TTL         | SSI transmit data output.   |
| 23         | VDD      | -        | Power       | Positive supply for logic and I/O pins.   |
| 24         | GND      | -        | Power       | Ground reference for logic and I/O pins.  |
| 25         | PD0      | I/O      | TTL         | GPIO port D bit 0.  |
| 26         | PD1      | I/O      | TTL         | GPIO port D bit 1.  |
| 27         | PD2      | I/O      | TTL         | GPIO port D bit 2.  |
|            | U1Rx     | I        | TTL         | UART1 receive data input.   |
| 28         | PD3      | I/O      | TTL         | GPIO port D bit 3.  |
|            | U1Tx     | O        | TTL         | UART1 transmit data output.   |
| 29         | PB0      | I/O      | TTL         | GPIO port B bit 0.  |
|            | CCP0     | I/O      | TTL         | Timer 0 capture input, compare output, or PWM output channel 0.                       |
| 30         | PB1      | I/O      | TTL         | GPIO port B bit 1.  |
|            | CCP2     | I/O      | TTL         | Timer 1 capture input, compare output, or PWM output channel 2.                       |
| 31         | GND      | -        | Power       | Ground reference for logic and I/O pins.  |
| 32         | VDD      | -        | Power       | Positive supply for logic and I/O pins.   |
| 33         | PB2      | I/O      | TTL         | GPIO port B bit 2.  |
|            | I2CSCL   | I/O      | OD          | I <sup>2</sup> C serial clock.  |
| 34         | PB3      | I/O      | TTL         | GPIO port B bit 3.  |
|            | I2CSDA   | I/O      | OD          | I <sup>2</sup> C serial data.   |
| 35         | PE0      | I/O      | TTL         | GPIO port E bit 0.  |

Table 16-1. Signals by Pin Number (Sheet 3 of 3)

| Pin Number | Pin Name                 | Pin Type | Buffer Type | Description                           |
|------------|--------------------------|----------|-------------|---------------------------------------|
| 36         | PE1                      | I/O      | TTL         | GPIO port E bit 1.                    |
| 37         | PC3                      | I/O      | TTL         | GPIO port C bit 3.                    |
|            | TDO                      | O        | TTL         | JTAG scan test data output.           |
|            | SWO                      | O        | TTL         | Serial-wire output.                   |
| 38         | PC2                      | I/O      | TTL         | GPIO port C bit 2.                    |
|            | TDI                      | I        | TTL         | JTAG scan test data input.            |
| 39         | PC1                      | I/O      | TTL         | GPIO port C bit 1.                    |
|            | TMS                      | I        | TTL         | JTAG scan test mode select input.     |
|            | SWDIO                    | I/O      | TTL         | Serial-wire debug input/output.       |
| 40         | PC0                      | I/O      | TTL         | GPIO port C bit 0.                    |
|            | TCK                      | I        | TTL         | JTAG scan test clock reference input. |
|            | SWCLK                    | I        | TTL         | Serial wire clock reference input.    |
| 41         | PB7                      | I/O      | TTL         | GPIO port B bit 7.                    |
|            | $\overline{\text{TRST}}$ | I        | TTL         | JTAG scan test reset input.           |
| 42         | PB6                      | I/O      | TTL         | GPIO port B bit 6.                    |
| 43         | PB5                      | I/O      | TTL         | GPIO port B bit 5.                    |
| 44         | PB4                      | I/O      | TTL         | GPIO port B bit 4.                    |
| 45         | ADC7                     | I        | Analog      | Analog-to-digital converter input 7.  |
| 46         | ADC6                     | I        | Analog      | Analog-to-digital converter input 6.  |
| 47         | ADC5                     | I        | Analog      | Analog-to-digital converter input 5.  |
| 48         | ADC4                     | I        | Analog      | Analog-to-digital converter input 4.  |

Table 16-2. Signals by Signal Name (Sheet 1 of 4)

| Pin Name | Pin Number | Pin Type | Buffer Type | Description                          |
|----------|------------|----------|-------------|--------------------------------------|
| ADC0     | 1          | I        | Analog      | Analog-to-digital converter input 0. |
| ADC1     | 2          | I        | Analog      | Analog-to-digital converter input 1. |
| ADC2     | 3          | I        | Analog      | Analog-to-digital converter input 2. |
| ADC3     | 4          | I        | Analog      | Analog-to-digital converter input 3. |
| ADC4     | 48         | I        | Analog      | Analog-to-digital converter input 4. |
| ADC5     | 47         | I        | Analog      | Analog-to-digital converter input 5. |

Table 16-2. Signals by Signal Name (Sheet 2 of 4)

| Pin Name | Pin Number | Pin Type | Buffer Type | Description   |
|----------|------------|----------|-------------|---|
| ADC6     | 46         | I        | Analog      | Analog-to-digital converter input 6.  |
| ADC7     | 45         | I        | Analog      | Analog-to-digital converter input 7.  |
| CCP0     | 29         | I/O      | TTL         | Timer 0 capture input, compare output, or PWM output channel 0.   |
| CCP1     | 13         | I/O      | TTL         | Timer 0 capture input, compare output, or PWM output channel 1.   |
| CCP2     | 30         | I/O      | TTL         | Timer 1 capture input, compare output, or PWM output channel 2.   |
| CCP3     | 12         | I/O      | TTL         | Timer 1 capture input, compare output, or PWM output channel 3.   |
| GND      | 8          | -        | Power       | Ground reference for logic and I/O pins.  |
| GND      | 16         | -        | Power       | Ground reference for logic and I/O pins.  |
| GND      | 24         | -        | Power       | Ground reference for logic and I/O pins.  |
| GND      | 31         | -        | Power       | Ground reference for logic and I/O pins.  |
| I2CSCL   | 33         | I/O      | OD          | I <sup>2</sup> C serial clock.  |
| I2CSDA   | 34         | I/O      | OD          | I <sup>2</sup> C serial data.   |
| LDO      | 6          | -        | Power       | The low drop-out regulator output voltage. This pin requires an external capacitor between the pin and GND of 1 $\mu$ F or greater. |
| OSC0     | 9          | I        | Analog      | Oscillator crystal input or an external clock reference input.  |
| OSC1     | 10         | O        | Analog      | Oscillator crystal output.  |
| PA0      | 17         | I/O      | TTL         | GPIO port A bit 0.  |
| PA1      | 18         | I/O      | TTL         | GPIO port A bit 1.  |
| PA2      | 19         | I/O      | TTL         | GPIO port A bit 2.  |
| PA3      | 20         | I/O      | TTL         | GPIO port A bit 3.  |
| PA4      | 21         | I/O      | TTL         | GPIO port A bit 4.  |
| PA5      | 22         | I/O      | TTL         | GPIO port A bit 5.  |
| PB0      | 29         | I/O      | TTL         | GPIO port B bit 0.  |
| PB1      | 30         | I/O      | TTL         | GPIO port B bit 1.  |
| PB2      | 33         | I/O      | TTL         | GPIO port B bit 2.  |
| PB3      | 34         | I/O      | TTL         | GPIO port B bit 3.  |
| PB4      | 44         | I/O      | TTL         | GPIO port B bit 4.  |
| PB5      | 43         | I/O      | TTL         | GPIO port B bit 5.  |
| PB6      | 42         | I/O      | TTL         | GPIO port B bit 6.  |
| PB7      | 41         | I/O      | TTL         | GPIO port B bit 7.  |
| PC0      | 40         | I/O      | TTL         | GPIO port C bit 0.  |

Table 16-2. Signals by Signal Name (Sheet 3 of 4)

| Pin Name                 | Pin Number | Pin Type | Buffer Type | Description   |
|--------------------------|------------|----------|-------------|---|
| PC1                      | 39         | I/O      | TTL         | GPIO port C bit 1.  |
| PC2                      | 38         | I/O      | TTL         | GPIO port C bit 2.  |
| PC3                      | 37         | I/O      | TTL         | GPIO port C bit 3.  |
| PC4                      | 14         | I/O      | TTL         | GPIO port C bit 4.  |
| PC5                      | 13         | I/O      | TTL         | GPIO port C bit 5.  |
| PC6                      | 12         | I/O      | TTL         | GPIO port C bit 6.  |
| PC7                      | 11         | I/O      | TTL         | GPIO port C bit 7.  |
| PD0                      | 25         | I/O      | TTL         | GPIO port D bit 0.  |
| PD1                      | 26         | I/O      | TTL         | GPIO port D bit 1.  |
| PD2                      | 27         | I/O      | TTL         | GPIO port D bit 2.  |
| PD3                      | 28         | I/O      | TTL         | GPIO port D bit 3.  |
| PE0                      | 35         | I/O      | TTL         | GPIO port E bit 0.  |
| PE1                      | 36         | I/O      | TTL         | GPIO port E bit 1.  |
| $\overline{\text{RST}}$  | 5          | I        | TTL         | System reset input.   |
| SSIClk                   | 19         | I/O      | TTL         | SSI clock reference (input when in slave mode and output in master mode).             |
| SSIFss                   | 20         | I/O      | TTL         | SSI frame enable (input for an SSI slave device and output for an SSI master device). |
| SSIRx                    | 21         | I        | TTL         | SSI receive data input.   |
| SSITx                    | 22         | O        | TTL         | SSI transmit data output.   |
| SWCLK                    | 40         | I        | TTL         | Serial wire clock reference input.  |
| SWDIO                    | 39         | I/O      | TTL         | Serial-wire debug input/output.   |
| SWO                      | 37         | O        | TTL         | Serial-wire output.   |
| TCK                      | 40         | I        | TTL         | JTAG scan test clock reference input.   |
| TDI                      | 38         | I        | TTL         | JTAG scan test data input.  |
| TDO                      | 37         | O        | TTL         | JTAG scan test data output.   |
| TMS                      | 39         | I        | TTL         | JTAG scan test mode select input.   |
| $\overline{\text{TRST}}$ | 41         | I        | TTL         | JTAG scan test reset input.   |
| U0Rx                     | 17         | I        | TTL         | UART0 receive data input.   |
| U0Tx                     | 18         | O        | TTL         | UART0 transmit data output.   |
| U1Rx                     | 27         | I        | TTL         | UART1 receive data input.   |

Table 16-2. Signals by Signal Name (Sheet 4 of 4)

| Pin Name | Pin Number | Pin Type | Buffer Type | Description                             |
|----------|------------|----------|-------------|---|
| U1Tx     | 28         | O        | TTL         | UART1 transmit data output.             |
| VDD      | 7          | -        | Power       | Positive supply for logic and I/O pins. |
| VDD      | 15         | -        | Power       | Positive supply for logic and I/O pins. |
| VDD      | 23         | -        | Power       | Positive supply for logic and I/O pins. |
| VDD      | 32         | -        | Power       | Positive supply for logic and I/O pins. |

Table 16-3. Signals by Function, Except for GPIO (Sheet 1 of 2)

| Function               | Pin Name | Pin Number | Pin Type | Buffer Type | Description   |
|------------------------|----------|------------|----------|-------------|---|
| ADC                    | ADC0     | 1          | I        | Analog      | Analog-to-digital converter input 0.                            |
|                        | ADC1     | 2          | I        | Analog      | Analog-to-digital converter input 1.                            |
|                        | ADC2     | 3          | I        | Analog      | Analog-to-digital converter input 2.                            |
|                        | ADC3     | 4          | I        | Analog      | Analog-to-digital converter input 3.                            |
|                        | ADC4     | 48         | I        | Analog      | Analog-to-digital converter input 4.                            |
|                        | ADC5     | 47         | I        | Analog      | Analog-to-digital converter input 5.                            |
|                        | ADC6     | 46         | I        | Analog      | Analog-to-digital converter input 6.                            |
|                        | ADC7     | 45         | I        | Analog      | Analog-to-digital converter input 7.                            |
| General-Purpose Timers | CCP0     | 29         | I/O      | TTL         | Timer 0 capture input, compare output, or PWM output channel 0. |
|                        | CCP1     | 13         | I/O      | TTL         | Timer 0 capture input, compare output, or PWM output channel 1. |
|                        | CCP2     | 30         | I/O      | TTL         | Timer 1 capture input, compare output, or PWM output channel 2. |
|                        | CCP3     | 12         | I/O      | TTL         | Timer 1 capture input, compare output, or PWM output channel 3. |
| I2C                    | I2CSCL   | 33         | I/O      | OD          | I <sup>2</sup> C serial clock.                                  |
|                        | I2CSDA   | 34         | I/O      | OD          | I <sup>2</sup> C serial data.                                   |
| JTAG/SWD/SWO           | SWCLK    | 40         | I        | TTL         | Serial-wire clock reference input.                              |
|                        | SWDIO    | 39         | I/O      | TTL         | Serial-wire debug input/output.                                 |
|                        | SWO      | 37         | O        | TTL         | Serial-wire output.   |
|                        | TCK      | 40         | I        | TTL         | JTAG scan test clock reference input.                           |
|                        | TDI      | 38         | I        | TTL         | JTAG scan test data input.                                      |
|                        | TDO      | 37         | O        | TTL         | JTAG scan test data output.                                     |

Table 16-3. Signals by Function, Except for GPIO (Sheet 2 of 2)

| Function                | Pin Name                 | Pin Number | Pin Type | Buffer Type | Description   |
|-------------------------|--------------------------|------------|----------|-------------|---|
|                         | TMS                      | 39         | I        | TTL         | JTAG scan test mode select input.   |
|                         | $\overline{\text{TRST}}$ | 41         | I        | TTL         | JTAG scan test reset input.   |
| Power                   | GND                      | 8          | -        | Power       | Ground reference for logic and I/O pins.  |
|                         | GND                      | 16         | -        | Power       | Ground reference for logic and I/O pins.  |
|                         | GND                      | 24         | -        | Power       | Ground reference for logic and I/O pins.  |
|                         | GND                      | 31         | -        | Power       | Ground reference for logic and I/O pins.  |
|                         | LDO                      | 6          | -        | Power       | The low drop-out regulator output voltage. This pin requires an external capacitor between the pin and GND of 1 $\mu\text{F}$ or greater. |
|                         | VDD                      | 7          | -        | Power       | Positive supply for logic and I/O pins.   |
|                         | VDD                      | 15         | -        | Power       | Positive supply for logic and I/O pins.   |
|                         | VDD                      | 23         | -        | Power       | Positive supply for logic and I/O pins.   |
|                         | VDD                      | 32         | -        | Power       | Positive supply for logic and I/O pins.   |
| SSI                     | SSIClk                   | 19         | I/O      | TTL         | SSI clock reference (input when in slave mode and output in master mode).   |
|                         | SSIFss                   | 20         | I/O      | TTL         | SSI frame enable (input for an SSI slave device and output for an SSI master device).   |
|                         | SSIRx                    | 21         | I        | TTL         | SSI receive data input.   |
|                         | SSITx                    | 22         | O        | TTL         | SSI transmit data output.   |
| System Control & Clocks | OSC0                     | 9          | I        | Analog      | Oscillator crystal input or an external clock reference input.  |
|                         | OSC1                     | 10         | O        | Analog      | Oscillator crystal output.  |
|                         | $\overline{\text{RST}}$  | 5          | I        | TTL         | System reset input.   |
| UART                    | U0Rx                     | 17         | I        | TTL         | UART0 receive data input.   |
|                         | U0Tx                     | 18         | O        | TTL         | UART0 transmit data output.   |
|                         | U1Rx                     | 27         | I        | TTL         | UART1 receive data input.   |
|                         | U1Tx                     | 28         | O        | TTL         | UART1 transmit data output.   |

Table 16-4. GPIO Pins and Alternate Functions (Sheet 1 of 2)

| GPIO Pin | Pin Number | Multiplexed Function | Multiplexed Function |
|----------|------------|----------------------|----------------------|
| PA0      | 17         | U0Rx                 |                      |
| PA1      | 18         | U0Tx                 |                      |

Table 16-4. GPIO Pins and Alternate Functions (Sheet 2 of 2)

| GPIO Pin | Pin Number | Multiplexed Function     | Multiplexed Function |
|----------|------------|--------------------------|----------------------|
| PA2      | 19         | SSIClk                   |                      |
| PA3      | 20         | SSIFss                   |                      |
| PA4      | 21         | SSIRx                    |                      |
| PA5      | 22         | SSITx                    |                      |
| PB0      | 29         | CCP0                     |                      |
| PB1      | 30         | CCP2                     |                      |
| PB2      | 33         | I2CSCL                   |                      |
| PB3      | 34         | I2CSDA                   |                      |
| PB4      | 44         |                          |                      |
| PB5      | 43         |                          |                      |
| PB6      | 42         |                          |                      |
| PB7      | 41         | $\overline{\text{TRST}}$ |                      |
| PC0      | 40         | TCK                      | SWCLK                |
| PC1      | 39         | TMS                      | SWDIO                |
| PC2      | 38         | TDI                      |                      |
| PC3      | 37         | TDO                      | SWO                  |
| PC4      | 14         |                          |                      |
| PC5      | 13         | CCP1                     |                      |
| PC6      | 12         | CCP3                     |                      |
| PC7      | 11         |                          |                      |
| PD0      | 25         |                          |                      |
| PD1      | 26         |                          |                      |
| PD2      | 27         | U1Rx                     |                      |
| PD3      | 28         | U1Tx                     |                      |
| PE0      | 35         |                          |                      |
| PE1      | 36         |                          |                      |



## 17 Operating Characteristics

**Table 17-1. Temperature Characteristics**

| Characteristic                           | Symbol | Value                     | Unit |
|--|--------|---------------------------|------|
| Operating temperature range <sup>a</sup> | $T_A$  | -40 to +85 for industrial | °C   |

a. Maximum storage temperature is 150°C.

**Table 17-2. Thermal Characteristics**

| Characteristic  | Symbol        | Value                               | Unit |
|---|---------------|-------------------------------------|------|
| Thermal resistance (junction to ambient) <sup>a</sup> | $\theta_{JA}$ | 76                                  | °C/W |
| Average junction temperature <sup>b</sup>             | $T_J$         | $T_A + (P_{AVG} \cdot \theta_{JA})$ | °C   |
| Maximum junction temperature                          | $T_{JMAX}$    | pending <sup>c</sup>                | °C   |

a. Junction to ambient thermal resistance  $\theta_{JA}$  numbers are determined by a package simulator.

b. Power dissipation is a function of temperature.

c. Pending characterization completion.

## 18 Electrical Characteristics

### 18.1 DC Characteristics

#### 18.1.1 Maximum Ratings

The maximum ratings are the limits to which the device can be subjected without permanently damaging the device.

**Note:** The device is not guaranteed to operate properly at the maximum ratings.

**Table 18-1. Maximum Ratings**

| Characteristic <sup>a</sup>                                 | Symbol   | Value       | Unit |
|---|----------|-------------|------|
| Supply voltage range ( $V_{DD}$ )                           | $V_{DD}$ | 0.0 to +3.6 | V    |
| Input voltage   | $V_{IN}$ | -0.3 to 5.5 | V    |
| Maximum current for pins, excluding pins operating as GPIOs | I        | 100         | mA   |
| Maximum current for GPIO pins                               | I        | 100         | mA   |

a. Voltages are measured with respect to GND.

**Important:** This device contains circuitry to protect the inputs against damage due to high-static voltages or electric fields; however, it is advised that normal precautions be taken to avoid application of any voltage higher than maximum-rated voltages to this high-impedance circuit. Reliability of operation is enhanced if unused inputs are connected to an appropriate logic voltage level (for example, either GND or  $V_{DD}$ ).

#### 18.1.2 Recommended DC Operating Conditions

**Table 18-2. Recommended DC Operating Conditions**

| Parameter | Parameter Name                               | Min            | Nom | Max            | Unit |
|-----------|--|----------------|-----|----------------|------|
| $V_{DD}$  | Supply voltage                               | 3.0            | 3.3 | 3.6            | V    |
| $V_{IH}$  | High-level input voltage                     | 2.0            | -   | 5.0            | V    |
| $V_{IL}$  | Low-level input voltage                      | -0.3           | -   | 1.3            | V    |
| $V_{SIH}$ | High-level input voltage for Schottky inputs | $0.8 * V_{DD}$ | -   | $V_{DD}$       | V    |
| $V_{SIL}$ | Low-level input voltage for Schottky inputs  | 0              | -   | $0.2 * V_{DD}$ | V    |
| $V_{OH}$  | High-level output voltage                    | 2.4            | -   | -              | V    |
| $V_{OL}$  | Low-level output voltage                     | -              | -   | 0.4            | V    |

Table 18-2. Recommended DC Operating Conditions (Continued)

| Parameter | Parameter Name                                   | Min | Nom | Max | Unit |
|-----------|--|-----|-----|-----|------|
| $I_{OH}$  | High-level source current, $V_{OH}=2.4\text{ V}$ |     |     |     |      |
|           | 2-mA Drive                                       | 2.0 | -   | -   | mA   |
|           | 4-mA Drive                                       | 4.0 | -   | -   | mA   |
|           | 8-mA Drive                                       | 8.0 | -   | -   | mA   |
| $I_{OL}$  | Low-level sink current, $V_{OL}=0.4\text{ V}$    |     |     |     |      |
|           | 2-mA Drive                                       | 2.0 | -   | -   | mA   |
|           | 4-mA Drive                                       | 4.0 | -   | -   | mA   |
|           | 8-mA Drive                                       | 8.0 | -   | -   | mA   |

### 18.1.3 On-Chip Low Drop-Out (LDO) Regulator Characteristics

Table 18-3. LDO Regulator Characteristics

| Parameter    | Parameter Name   | Min  | Nom | Max  | Unit          |
|--------------|--|------|-----|------|---------------|
| $V_{LDOOUT}$ | Programmable internal (logic) power supply output value  | 2.25 | -   | 2.75 | V             |
|              | Output voltage accuracy                                  | -    | 2%  | -    | %             |
| $t_{PON}$    | Power-on time  | -    | -   | 100  | $\mu\text{s}$ |
| $t_{ON}$     | Time on  | -    | -   | 200  | $\mu\text{s}$ |
| $t_{OFF}$    | Time off   | -    | -   | 100  | $\mu\text{s}$ |
| $V_{STEP}$   | Step programming incremental voltage                     | -    | 50  | -    | mV            |
| $C_{LDO}$    | External filter capacitor size for internal power supply | -    | 1   | -    | $\mu\text{F}$ |

### 18.1.4 Power Specifications

The power measurements specified in Table 18-4 are run on the core processor using SRAM with the following specifications:

- $V_{DD}=3.3\text{ V}$
- LDO=2.5
- Temperature=25°C
- System Clock=50 MHz (with PLL)
- Code while (1) { } executed from SRAM with no active peripherals

**Table 18-4. Power Specifications**

| Parameter           | Parameter Name  | Min | Nom                  | Max                  | Unit |
|---------------------|-----------------|-----|----------------------|----------------------|------|
| $I_{DD\_RUN}$       | Run mode        | -   | 70 <sup>a</sup>      | pending <sup>a</sup> | mA   |
| $I_{DD\_SLEEP}$     | Sleep mode      | -   | pending <sup>a</sup> | pending <sup>a</sup> | μA   |
| $I_{DD\_DEEPSLEEP}$ | Deep-Sleep mode | -   | pending <sup>a</sup> | pending <sup>a</sup> | μA   |

a. Pending characterization completion.

### 18.1.5 Flash Memory Characteristics

**Table 18-5. Flash Memory Characteristics**

| Parameter   | Parameter Name  | Min    | Nom | Max | Unit   |
|-------------|---|--------|-----|-----|--------|
| $PE_{CYC}$  | Number of guaranteed program/erase cycles <sup>a</sup> before failure | 10,000 | -   | -   | cycles |
| $T_{RET}$   | Data retention at average operating temperature of 85°C               | 10     | -   | -   | years  |
| $T_{PROG}$  | Word program time   | 20     | -   | -   | μs     |
| $T_{ERASE}$ | Page erase time   | 20     | -   | -   | ms     |
| $T_{ME}$    | Mass erase time   | 200    | -   | -   | ms     |

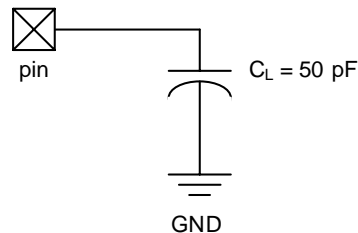
a. A program/erase cycle is defined as switching the bits from 1-> 0 -> 1.

## 18.2 AC Characteristics

### 18.2.1 Load Conditions

Unless otherwise specified, the following conditions are true for all timing measurements. Timing measurements are for 4-mA drive strength.

**Figure 18-1. Load Conditions**



### 18.2.2 Clocks

**Table 18-6. Phase Locked Loop (PLL) Characteristics**

| Parameter                | Parameter Name                        | Min      | Nom | Max   | Unit |
|--------------------------|---------------------------------------|----------|-----|-------|------|
| f <sub>REF_CRYSTAL</sub> | Crystal reference <sup>a</sup>        | 3.579545 | -   | 8.192 | MHz  |
| f <sub>REF_EXT</sub>     | External clock reference <sup>a</sup> | 3.579545 | -   | 8.192 | MHz  |
| f <sub>PLL</sub>         | PLL frequency <sup>b</sup>            | -        | 200 | -     | MHz  |
| T <sub>READY</sub>       | PLL lock time                         | -        | -   | 0.5   | ms   |

a. The exact value is determined by the crystal value programmed into the XTAL field of the **Run-Mode Clock Configuration (RCC)** register (see page 75).

b. PLL frequency is automatically calculated by the hardware based on the XTAL field of the **RCC** register.

**Table 18-7. Clock Characteristics**

| Parameter                       | Parameter Name  | Min | Nom | Max  | Unit |
|---------------------------------|---|-----|-----|------|------|
| f <sub>IOSC</sub>               | Internal oscillator frequency   | 7   | 15  | 22   | MHz  |
| f <sub>MOSC</sub>               | Main oscillator frequency   | 1   | -   | 8    | MHz  |
| t <sub>MOSC_PER</sub>           | Main oscillator period  | 125 | -   | 1000 | ns   |
| f <sub>REF_CRYSTAL_BYPASS</sub> | Crystal reference using the main oscillator (PLL in BYPASS mode) <sup>a</sup> | 1   | -   | 8    | MHz  |
| f <sub>REF_EXT_BYPASS</sub>     | External clock reference (PLL in BYPASS mode) <sup>a</sup>                    | 0   | -   | 50   | MHz  |
| f <sub>SYSTEM_CLOCK</sub>       | System clock  | 0   | -   | 50   | MHz  |

a. The ADC module cannot be used when the PLL is in Bypass mode (BYPASS set to 1 in the **RCC** register).

### 18.2.3 Temperature Sensor

**Table 18-8. Temperature Sensor Characteristics**

| Parameter    | Parameter Name                      | Min | Nom | Max       | Unit               |
|--------------|-------------------------------------|-----|-----|-----------|--------------------|
| $V_{T_{SO}}$ | Output voltage                      | 0.3 | -   | 2.7       | V                  |
| $t_{TSERR}$  | Output voltage temperature accuracy | -   | -   | $\pm 3.5$ | $^{\circ}\text{C}$ |
| $t_{TSNL}$   | Output temperature nonlinearity     | -   | -   | $\pm 1$   | $^{\circ}\text{C}$ |

### 18.2.4 Analog-to-Digital Converter

**Table 18-9. ADC Characteristics**

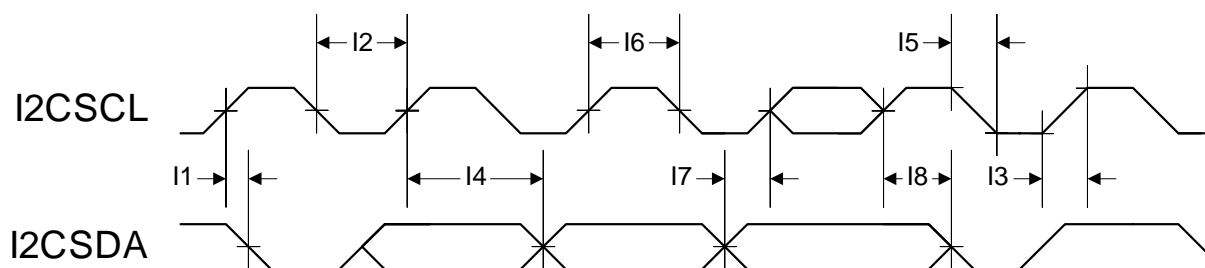
| Parameter     | Parameter Name  | Min | Nom  | Max     | Unit                          |
|---------------|---|-----|------|---------|-------------------------------|
| $V_{ADCIN}$   | Maximum single-ended, full-scale analog input voltage | -   | -    | 3.0     | V                             |
|               | Minimum single-ended, full-scale analog input voltage | -   | -    | 0       | V                             |
|               | Maximum differential, full-scale analog input voltage | -   | -    | 1.5     | V                             |
|               | Minimum differential, full-scale analog input voltage | -   | -    | -1.5    | V                             |
| $C_{ADCIN}$   | Equivalent input capacitance                          | -   | 1    | -       | pF                            |
| N             | Resolution  | -   | 10   | -       | bits                          |
| $f_{ADC}$     | ADC internal clock frequency                          | 14  | 16   | 18      | MHz                           |
| $t_{ADCCONV}$ | Conversion time                                       | -   | -    | 16      | $t_{ADC}$ cycles <sup>a</sup> |
| $f_{ADCCONV}$ | Conversion rate                                       | 875 | 1000 | 1125    | k samples/s                   |
| INL           | Integral nonlinearity                                 | -   | -    | $\pm 1$ | LSB                           |
| DNL           | Differential nonlinearity                             | -   | -    | $\pm 1$ | LSB                           |
| OFF           | Offset  | -   | -    | +2      | LSB                           |
| GAIN          | Gain  | -   | -    | $\pm 2$ | LSB                           |

a.  $t_{ADC} = 1/f_{ADC \text{ clock}}$

18.2.5 I<sup>2</sup>CTable 18-10. I<sup>2</sup>C Characteristics

| Parameter No.   | Parameter         | Parameter Name  | Min | Nom | Max          | Unit          |
|-----------------|-------------------|---|-----|-----|--------------|---------------|
| I1 <sup>a</sup> | t <sub>SCH</sub>  | Start condition hold time   | 36  | -   | -            | system clocks |
| I2 <sup>a</sup> | t <sub>LP</sub>   | Clock Low period  | 36  | -   | -            | system clocks |
| I3 <sup>b</sup> | t <sub>SRT</sub>  | I <sup>2</sup> C <sub>SCL</sub> /I <sup>2</sup> C <sub>SDA</sub> rise time (V <sub>IL</sub> =0.5 V to V <sub>IH</sub> =2.4 V) | -   | -   | (see note b) | ns            |
| I4 <sup>a</sup> | t <sub>DH</sub>   | Data hold time  | 2   | -   | -            | system clocks |
| I5 <sup>c</sup> | t <sub>SFT</sub>  | I <sup>2</sup> C <sub>SCL</sub> /I <sup>2</sup> C <sub>SDA</sub> fall time (V <sub>IH</sub> =2.4 V to V <sub>IL</sub> =0.5 V) | -   | 9   | 10           | ns            |
| I6 <sup>a</sup> | t <sub>HT</sub>   | Clock High time   | 24  | -   | -            | system clocks |
| I7 <sup>a</sup> | t <sub>DS</sub>   | Data setup time   | 18  | -   | -            | system clocks |
| I8 <sup>a</sup> | t <sub>SCSR</sub> | Start condition setup time (for repeated start condition only)  | 36  | -   | -            | system clocks |
| I9 <sup>a</sup> | t <sub>SCS</sub>  | Stop condition setup time   | 24  | -   | -            | system clocks |

- a. Values depend on the value programmed into the TPR bit in the I<sup>2</sup>C Master Timer Period (I2CMTPR) register (see page 314); a TPR programmed for the maximum I<sup>2</sup>C<sub>SCL</sub> frequency (TPR=0x2) results in a minimum output timing as shown in the table above. The I<sup>2</sup>C interface is designed to scale the actual data transition time to move it to the middle of the I<sup>2</sup>C<sub>SCL</sub> Low period. The actual position is affected by the value programmed into the TPR; however, the numbers given in the above values are minimum values.
- b. Because I<sup>2</sup>C<sub>SCL</sub> and I<sup>2</sup>C<sub>SDA</sub> are open-drain-type outputs, which the controller can only actively drive Low, the time I<sup>2</sup>C<sub>SCL</sub> or I<sup>2</sup>C<sub>SDA</sub> takes to reach a high level depends on external signal capacitance and pull-up resistor values.
- c. Specified at a nominal 50 pF load.

Figure 18-2. I<sup>2</sup>C Timing

### 18.2.6 Synchronous Serial Interface (SSI)

Table 18-11. SSI Characteristics

| Parameter No. | Parameter       | Parameter Name                    | Min | Nom | Max   | Unit           |
|---------------|-----------------|-----------------------------------|-----|-----|-------|----------------|
| S1            | $t_{CLK\_PER}$  | SSIClk cycle time                 | 2   | -   | 65024 | system clocks  |
| S2            | $t_{CLK\_HIGH}$ | SSIClk high time                  | -   | 1/2 | -     | $t_{CLK\_PER}$ |
| S3            | $t_{CLK\_LOW}$  | SSIClk low time                   | -   | 1/2 | -     | $t_{CLK\_PER}$ |
| S4            | $t_{CLKRF}$     | SSIClk rise/fall time             | -   | 7.4 | 26    | ns             |
| S5            | $t_{DMD}$       | Data from master valid delay time | 0   | -   | 20    | ns             |
| S6            | $t_{DMS}$       | Data from master setup time       | 20  | -   | -     | ns             |
| S7            | $t_{DMH}$       | Data from master hold time        | 40  | -   | -     | ns             |
| S8            | $t_{DSS}$       | Data from slave setup time        | 20  | -   | -     | ns             |
| S9            | $t_{DSH}$       | Data from slave hold time         | 40  | -   | -     | ns             |

Figure 18-3. SSI Timing for TI Frame Format (FRF=01), Single Transfer Timing Measurement

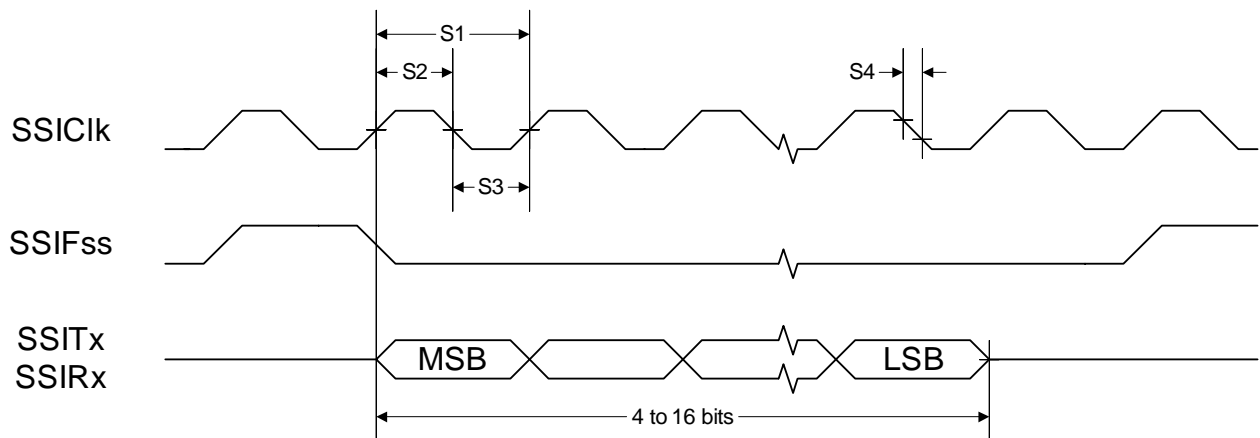




Figure 18-4. SSI Timing for MICROWIRE Frame Format (FRF=10), Single Transfer

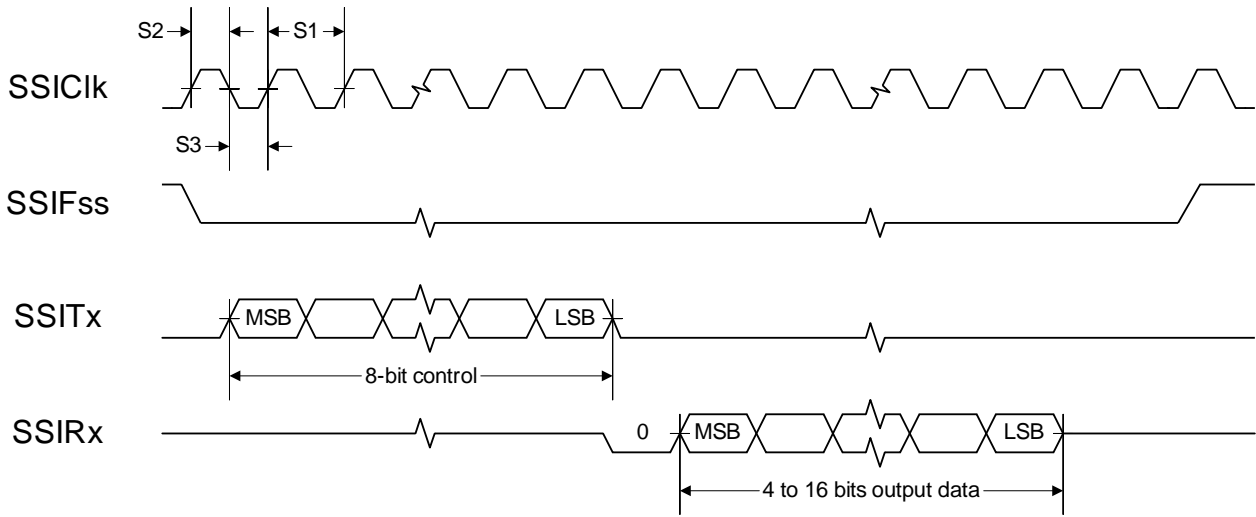
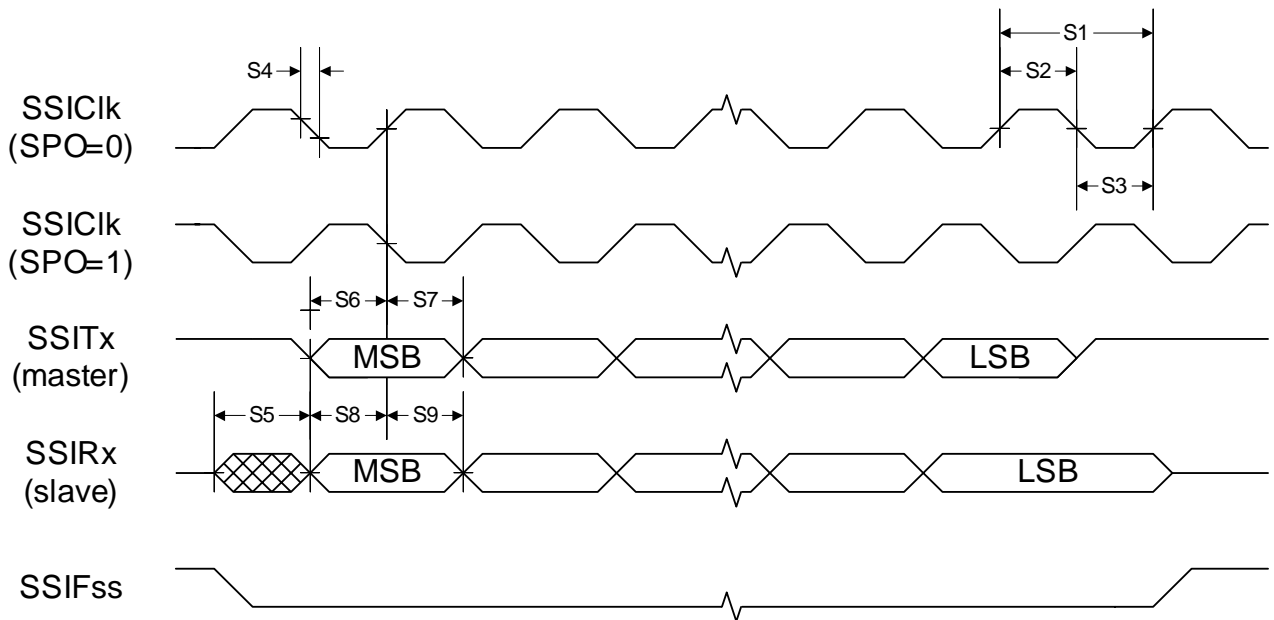


Figure 18-5. SSI Timing for SPI Frame Format (FRF=00), with SPH=1



## 18.2.7 JTAG and Boundary Scan

Table 18-12. JTAG Characteristics

| Parameter No.         | Parameter                              | Parameter Name                           | Min | Nom                   | Max | Unit |
|-----------------------|--|--|-----|-----------------------|-----|------|
| J1                    | $f_{TCK}$                              | TCK operational clock frequency          | 0   | -                     | 10  | MHz  |
| J2                    | $t_{TCK}$                              | TCK operational clock period             | 100 | -                     | -   | ns   |
| J3                    | $t_{TCK\_LOW}$                         | TCK clock Low time                       | -   | $\frac{1}{2} t_{TCK}$ | -   | ns   |
| J4                    | $t_{TCK\_HIGH}$                        | TCK clock High time                      | -   | $\frac{1}{2} t_{TCK}$ | -   | ns   |
| J5                    | $t_{TCK\_R}$                           | TCK rise time                            | 0   | -                     | 10  | ns   |
| J6                    | $t_{TCK\_F}$                           | TCK fall time                            | 0   | -                     | 10  | ns   |
| J7                    | $t_{TMS\_SU}$                          | TMS setup time to TCK rise               | 20  | -                     | -   | ns   |
| J8                    | $t_{TMS\_HLD}$                         | TMS hold time from TCK rise              | 20  | -                     | -   | ns   |
| J9                    | $t_{TDI\_SU}$                          | TDI setup time to TCK rise               | 25  | -                     | -   | ns   |
| J10                   | $t_{TDI\_HLD}$                         | TDI hold time from TCK rise              | 25  | -                     | -   | ns   |
| J11<br>$t_{TDO\_ZDV}$ | TCK fall to Data Valid from High-Z     | 2-mA drive                               | -   | 23                    | 35  | ns   |
|                       |  | 4-mA drive                               |     | 15                    | 26  | ns   |
|                       |  | 8-mA drive                               |     | 14                    | 25  | ns   |
|                       |  | 8-mA drive with slew rate control        |     | 18                    | 29  | ns   |
| J12<br>$t_{TDO\_DV}$  | TCK fall to Data Valid from Data Valid | 2-mA drive                               | -   | 21                    | 35  | ns   |
|                       |  | 4-mA drive                               |     | 14                    | 25  | ns   |
|                       |  | 8-mA drive                               |     | 13                    | 24  | ns   |
|                       |  | 8-mA drive with slew rate control        |     | 18                    | 28  | ns   |
| J13<br>$t_{TDO\_DVZ}$ | TCK fall to High-Z from Data Valid     | 2-mA drive                               | -   | 9                     | 11  | ns   |
|                       |  | 4-mA drive                               |     | 7                     | 9   | ns   |
|                       |  | 8-mA drive                               |     | 6                     | 8   | ns   |
|                       |  | 8-mA drive with slew rate control        |     | 7                     | 9   | ns   |
| J14                   | $t_{TRST}$                             | $\overline{TRST}$ assertion time         | 100 | -                     | -   | ns   |
| J15                   | $t_{TRST\_SU}$                         | $\overline{TRST}$ setup time to TCK rise | 10  | -                     | -   | ns   |

Figure 18-6. JTAG Test Clock Input Timing

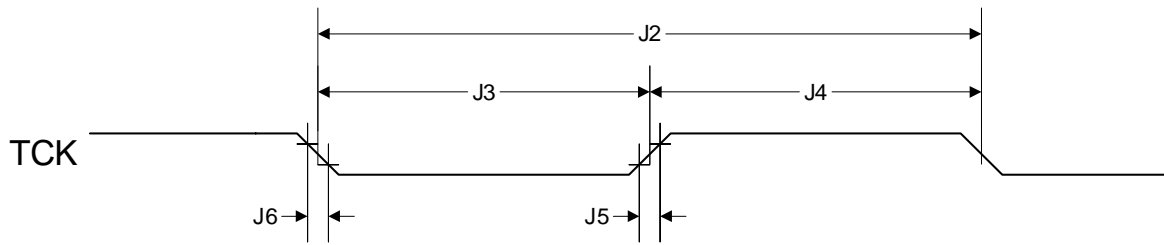


Figure 18-7. JTAG Test Access Port (TAP) Timing

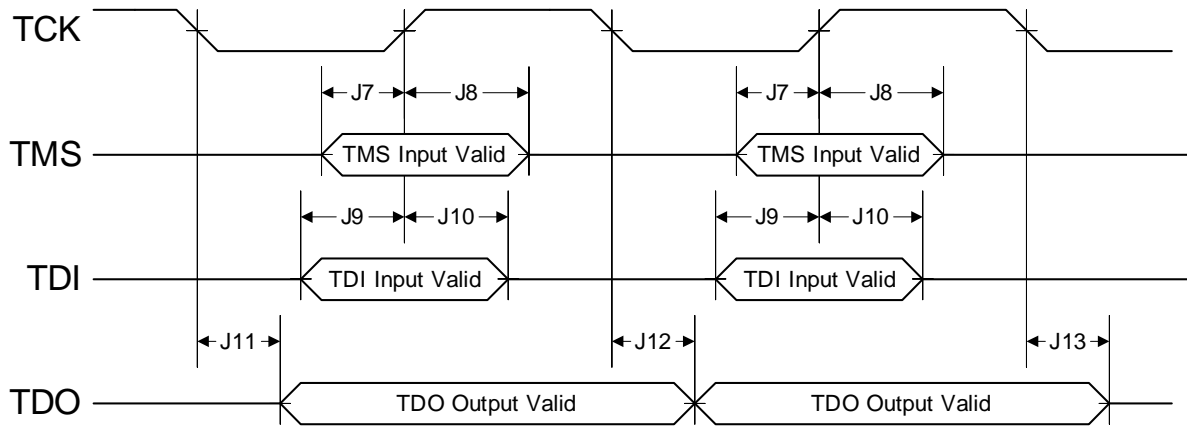
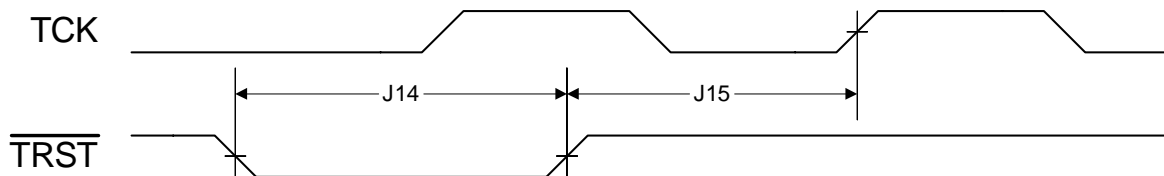


Figure 18-8. JTAG  $\overline{\text{TRST}}$  Timing



## 18.2.8 General-Purpose I/O

Table 18-13. GPIO Characteristics<sup>a</sup>

| Parameter           | Parameter Name  | Condition                         | Min | Nom | Max | Unit |
|---------------------|---|-----------------------------------|-----|-----|-----|------|
| t <sub>GPIO R</sub> | GPO Rise Time<br>(from 20% to 80%<br>of V <sub>DD</sub> ) | 2-mA drive                        | -   | 17  | 26  | ns   |
|                     |   | 4-mA drive                        |     | 9   | 13  | ns   |
|                     |   | 8-mA drive                        |     | 6   | 9   | ns   |
|                     |   | 8-mA drive with slew rate control |     | 10  | 12  | ns   |
| t <sub>GPIO F</sub> | GPO Fall Time<br>(from 80% to 20%<br>of V <sub>DD</sub> ) | 2-mA drive                        | -   | 17  | 25  | ns   |
|                     |   | 4-mA drive                        |     | 8   | 12  | ns   |
|                     |   | 8-mA drive                        |     | 6   | 10  | ns   |
|                     |   | 8-mA drive with slew rate control |     | 11  | 13  | ns   |

a. All GPIOs are 5 V-tolerant.

## 18.2.9 Reset

Table 18-14. Reset Characteristics

| Parameter No. | Parameter            | Parameter Name   | Min  | Nom | Max  | Unit |
|---------------|----------------------|--|------|-----|------|------|
| R1            | V <sub>TH</sub>      | Reset threshold  | -    | 2.0 | -    | V    |
| R2            | V <sub>BTH</sub>     | Brown-Out threshold  | 2.85 | 2.9 | 2.95 | V    |
| R3            | T <sub>POR</sub>     | Power-On Reset timeout   | -    | 10  | -    | ms   |
| R4            | T <sub>BOR</sub>     | Brown-Out timeout  | -    | 500 | -    | μs   |
| R5            | T <sub>IRPOR</sub>   | Internal reset timeout after POR   | 15   | -   | 30   | ms   |
| R6            | T <sub>IRBOR</sub>   | Internal reset timeout after BOR <sup>a</sup>                              | 2.5  | -   | 20   | μs   |
| R7            | T <sub>IRHWR</sub>   | Internal reset timeout after hardware reset ( $\overline{\text{RST}}$ pin) | 15   | -   | 30   | ms   |
| R8            | T <sub>IRSWR</sub>   | Internal reset timeout after software-initiated system reset <sup>a</sup>  | 2.5  | -   | 20   | μs   |
| R9            | T <sub>IRWDR</sub>   | Internal reset timeout after watchdog reset <sup>a</sup>                   | 2.5  | -   | 20   | μs   |
| R10           | T <sub>IRLDOR</sub>  | Internal reset timeout after LDO reset <sup>a</sup>                        | 2.5  | -   | 20   | μs   |
| R11           | T <sub>VDDRISE</sub> | Supply voltage (V <sub>DD</sub> ) rise time (0V-3.3V)                      |      |     | 100  | ms   |

a. 20 \* t<sub>MOSC\_PER</sub>

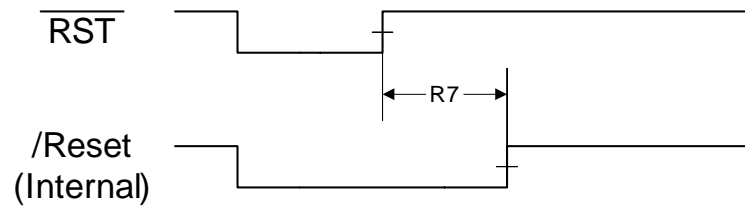
Figure 18-9. External Reset Timing ( $\overline{\text{RST}}$ )

Figure 18-10. Power-On Reset Timing

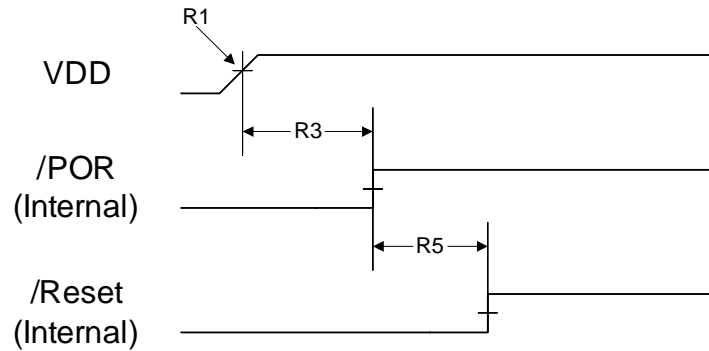


Figure 18-11. Brown-Out Reset Timing

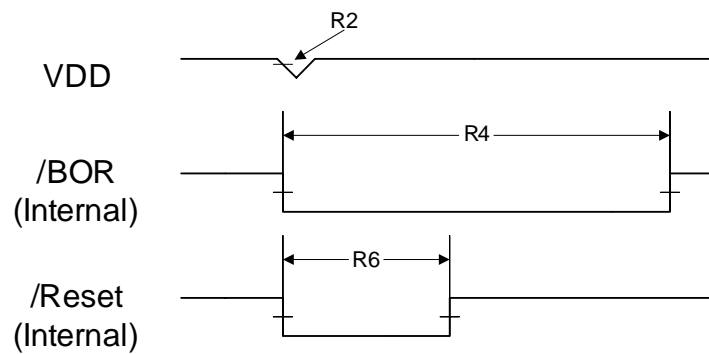


Figure 18-12. Software Reset Timing

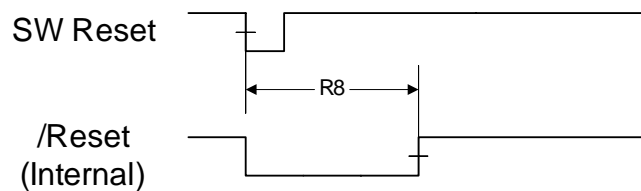


Figure 18-13. Watchdog Reset Timing

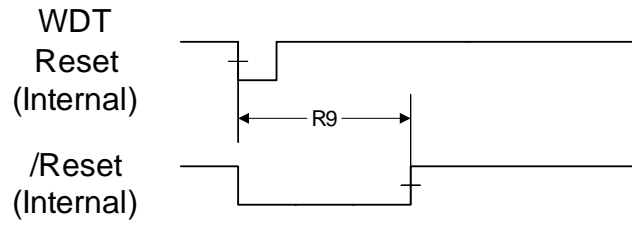
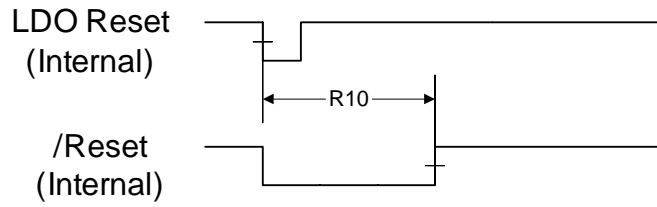
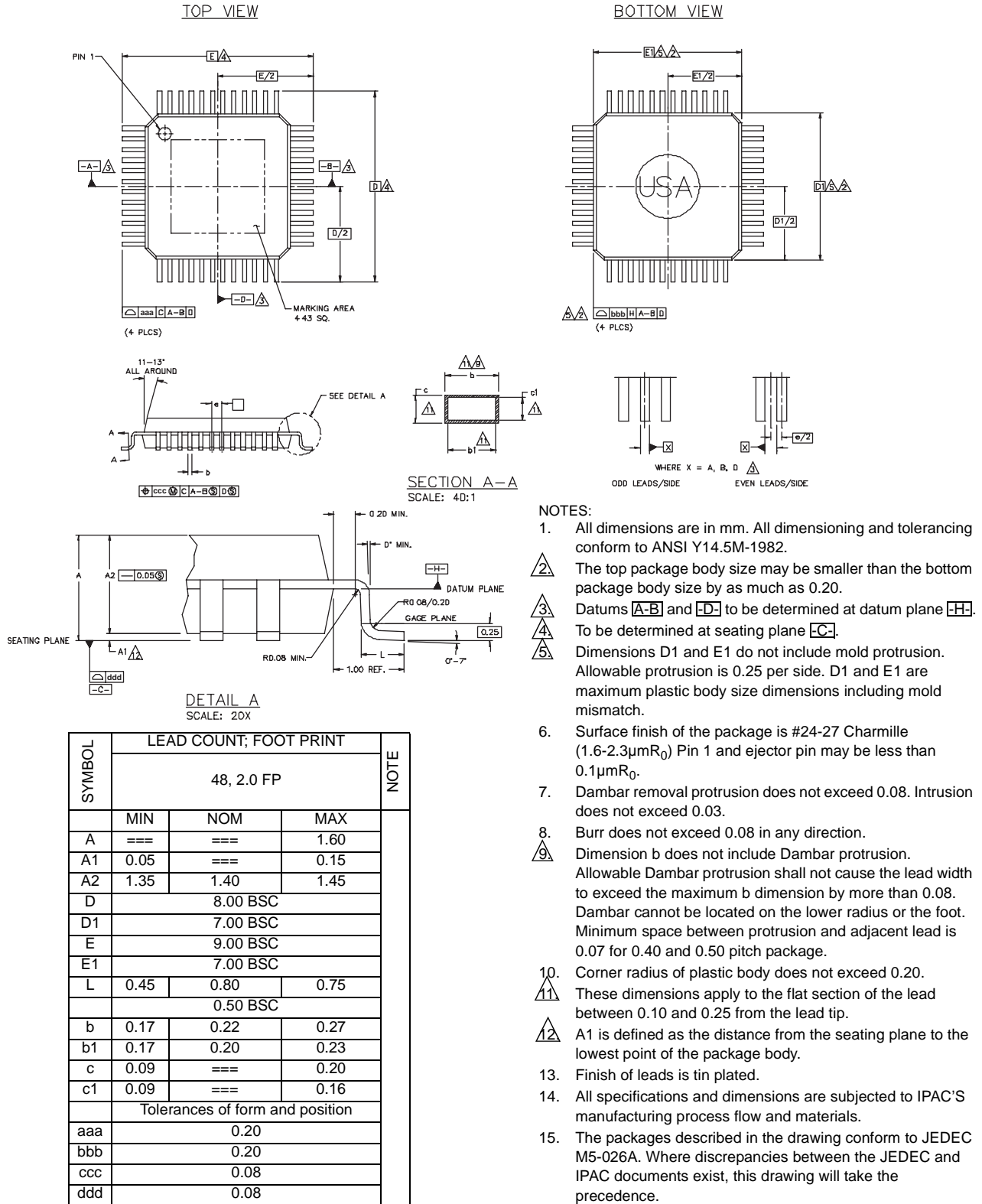


Figure 18-14. LDO Reset Timing



# 19 Package Information

Figure 19-1. 48-Pin LQFP Package



| SYMBOL                          | LEAD COUNT; FOOT PRINT |      |      | NOTE |
|---------------------------------|------------------------|------|------|------|
|                                 | 48, 2.0 FP             |      |      |      |
|                                 | MIN                    | NOM  | MAX  |      |
| A                               | ===                    | ===  | 1.60 |      |
| A1                              | 0.05                   | ===  | 0.15 |      |
| A2                              | 1.35                   | 1.40 | 1.45 |      |
| D                               | 8.00 BSC               |      |      |      |
| D1                              | 7.00 BSC               |      |      |      |
| E                               | 9.00 BSC               |      |      |      |
| E1                              | 7.00 BSC               |      |      |      |
| L                               | 0.45                   | 0.80 | 0.75 |      |
|                                 | 0.50 BSC               |      |      |      |
| b                               | 0.17                   | 0.22 | 0.27 |      |
| b1                              | 0.17                   | 0.20 | 0.23 |      |
| c                               | 0.09                   | ===  | 0.20 |      |
| c1                              | 0.09                   | ===  | 0.16 |      |
| Tolerances of form and position |                        |      |      |      |
| aaa                             | 0.20                   |      |      |      |
| bbb                             | 0.20                   |      |      |      |
| ccc                             | 0.08                   |      |      |      |
| ddd                             | 0.08                   |      |      |      |

---

# Appendix A. Serial Flash Loader

The Stellaris serial flash loader is used to download code to the flash memory of a device without the use of a debug interface. The serial flash loader uses a simple packet interface to provide synchronous communication with the device. The flash loader runs off the crystal and does not enable the PLL, so its speed is determined by the crystal used. The two serial interfaces that can be used are the UART0 and SSI interfaces. For simplicity, both the data format and communication protocol are identical for both serial interfaces.

## A.1 Interfaces

Once communication with the flash loader is established via one of the serial interfaces, that interface is used until the flash loader is reset or new code takes over. For example, once you start communicating using the SSI port, communications with the flash loader via the UART are disabled until the device is reset.

### A.1.1 UART

The Universal Asynchronous Receivers/Transmitters (UART) communication uses a fixed serial format of 8 bits of data, no parity, and 1 stop bit. The baud rate used for communication is automatically detected by the flash loader and can be any valid baud rate supported by the host and the device. The auto detection sequence requires that the baud rate should be no more than 1/32 the crystal frequency of the board that is running the serial flash loader. This is actually the same as the hardware limitation for the maximum baud rate for any UART on a Stellaris device.

In order to determine the baud rate, the serial flash loader needs to determine the relationship between its own crystal frequency and the baud rate. This is enough information for the flash loader to configure its UART to the same baud rate as the host. This automatic baud rate detection allows the host to use any valid baud rate that it wants to communicate with the device.

The method used to perform this automatic synchronization relies on the host sending the flash loader two bytes that are both 0x55. This generates a series of pulses to the flash loader that it can use to calculate the ratios needed to program the UART to match the host's baud rate. After the host sends the pattern, it attempts to read back one byte of data from the UART. The flash loader returns the value of 0xCC to indicate successful detection of the baud rate. If this byte is not received after at least twice the time required to transfer the two bytes, the host can resend another pattern of 0x55, 0x55, and wait for the 0xCC byte again until the flash loader acknowledges that it has received a synchronization pattern correctly. For example, the time to wait for data back from the flash loader should be calculated as at least  $2 * (20(\text{bits}/\text{sync})/\text{baud rate} (\text{bits}/\text{sec}))$ . For a baud rate of 115200, this time is  $2 * (20/115200)$  or 0.35ms.

### A.1.2 SSI

The Synchronous Serial Interface (SSI) port also uses a fixed serial format for communications, with the framing defined as Motorola format with SPH set to 1 and SPO set to 1. See the section on SSI formats for more details on this transfer protocol. Like the UART, this interface has hardware requirements that limit the maximum speed that the SSI clock can run. This allows the SSI clock to be at most 1/12 the crystal frequency of the board running the flash loader. Since the host device is the master, the SSI on the flash loader device does not need to determine the clock as it is provided directly by the host.

## A.2 Packet Handling

All communications, with the exception of the UART auto-baud, are done via defined packets that are acknowledged (ACK) or not acknowledged (NAK) by the devices. The packets use the same



format for receiving and sending packets, including the method used to acknowledge successful or unsuccessful reception of a packet.

### A.2.1 Packet Format

All packets sent and received from the device use the following byte-packed format.

```
struct
{
    unsigned char ucSize;
    unsigned char ucChecksum;
    unsigned char Data[];
};
```

ucSize – The first byte received holds the total size of the transfer including the size and checksum bytes.

ucChecksum – This holds a simple checksum of the bytes in the data buffer only. The algorithm is  $Data[0]+Data[1]+\dots+Data[ucSize-3]$ .

Data – This is the raw data intended for the device, which is formatted in some form of command interface. There should be ucSize – 2 bytes of data provided in this buffer to or from the device.

### A.2.2 Sending Packets

The actual bytes of the packet can be sent individually or all at once, the only limitation is that commands that cause flash memory access should limit the download sizes to prevent losing bytes during flash programming. This limitation is discussed further in the commands that interact with the flash.

Once the packet has been formatted correctly by the host, it should be sent out over the UART or SSI interface. Then the host should poll the UART or SSI interface for the first non-zero data returned from the device. The first non-zero byte will either be an ACK (0xCC) or a NAK (0x33) byte from the device indicating the packet was received successfully (ACK) or unsuccessfully (NAK). This does not indicate that the actual contents of the command issued in the data portion of the packet were valid, just that the packet was received correctly.

### A.2.3 Receiving Packets

The flash loader sends a packet of data in the same format that it receives a packet. The flash loader may transfer leading zero data before the first actual byte of data is sent out. The first non-zero byte is the size of the packet followed by a checksum byte, and finally followed by the data itself. There is no break in the data after the first non-zero byte is sent from the flash loader. Once the device communicating with the flash loader receives all the bytes, it must either ACK or NAK the packet to indicate that the transmission was successful. The appropriate response after sending a NAK to the flash loader is to resend the command that failed and request the data again. If needed, the host may send leading zeros before sending down the ACK/NAK signal to the flash loader, as the flash loader only accepts the first non-zero data as a valid response. This zero padding is needed by the SSI interface in order to receive data to or from the flash loader.

## A.3 Commands

The next section defines the list of commands that can be sent to the flash loader. The first byte of the data should always be one of the defined commands, followed by data or parameters as determined by the command that is sent.

---

### A.3.1 **COMMAND\_PING (0x20)**

This command simply accepts the command and sets the global status to success. The format of the packet is as follows:

```
Byte [0] = 0x03;  
Byte [1] = checksum (Byte [2] );  
Byte [2] = COMMAND_PING;
```

The ping command has 3 bytes and the value for COMMAND\_PING is 0x20 and the checksum of one byte is that same byte, making Byte[1] also 0x20. Since the ping command has no real return status, the receipt of an ACK can be interpreted as a successful ping to the flash loader.

### A.3.2 **COMMAND\_GET\_STATUS (0x23)**

This command returns the status of the last command that was issued. Typically, this command should be sent after every command to ensure that the previous command was successful or to properly respond to a failure. The command requires one byte in the data of the packet and should be followed by reading a packet with one byte of data that contains a status code. The last step is to ACK or NAK the received data so the flash loader knows that the data has been read.

```
Byte [0] = 0x03  
Byte [1] = checksum (Byte [2] )  
Byte [2] = COMMAND_GET_STATUS
```

### A.3.3 **COMMAND\_DOWNLOAD (0x21)**

This command is sent to the flash loader to indicate where to store data and how many bytes will be sent by the COMMAND\_SEND\_DATA commands that follow. The command consists of two 32-bit values that are both transferred MSB first. The first 32-bit value is the address to start programming data into, while the second is the 32-bit size of the data that will be sent. This command also triggers an erase of the full area to be programmed so this command takes longer than other commands. This results in a longer time to receive the ACK/NAK back from the board. This command should be followed by a COMMAND\_GET\_STATUS to ensure that the Program Address and Program size are valid for the device running the flash loader.

The format of the packet to send this command is as follows:

```
Byte [0] = 11  
Byte [1] = checksum (Bytes [2 : 10] )  
Byte [2] = COMMAND_DOWNLOAD  
Byte [3] = Program Address [31:24]  
Byte [4] = Program Address [23:16]  
Byte [5] = Program Address [15:8]  
Byte [6] = Program Address [7:0]  
Byte [7] = Program Size [31:24]  
Byte [8] = Program Size [23:16]  
Byte [9] = Program Size [15:8]  
Byte [10] = Program Size [7:0]
```

### A.3.4 **COMMAND\_SEND\_DATA (0x24)**

This command should only follow a COMMAND\_DOWNLOAD command or another COMMAND\_SEND\_DATA command if more data is needed. Consecutive send data commands

automatically increment address and continue programming from the previous location. The caller should limit transfers of data to a maximum 8 bytes of packet data to allow the flash to program successfully and not overflow input buffers of the serial interfaces. The command terminates programming once the number of bytes indicated by the COMMAND\_DOWNLOAD command has been received. Each time this function is called it should be followed by a COMMAND\_GET\_STATUS to ensure that the data was successfully programmed into the flash. If the flash loader sends a NAK to this command, the flash loader does not increment the current address to allow retransmission of the previous data.

```
Byte [0] = 11
Byte [1] = checksum (Bytes [2 : 10] )
Byte [2] = COMMAND_SEND_DATA
Byte [3] = Data [0]
Byte [4] = Data [1]
Byte [5] = Data [2]
Byte [6] = Data [3]
Byte [7] = Data [4]
Byte [8] = Data [5]
Byte [9] = Data [6]
Byte [10] = Data [7]
```

### A.3.5 COMMAND\_RUN (0x22)

This command is used to tell the flash loader to execute from the address passed as the parameter in this command. This command consists of a single 32-bit value that is interpreted as the address to execute. The 32-bit value is transmitted MSB first and the flash loader responds with an ACK signal back to the host device before actually executing the code at the given address. This allows the host to know that the command was received successfully and the code is now running.

```
Byte [0] = 7
Byte [1] = checksum (Bytes [2 : 6] )
Byte [2] = COMMAND_RUN
Byte [3] = Execute Address [31 : 24]
Byte [4] = Execute Address [23 : 16]
Byte [5] = Execute Address [15 : 8]
Byte [6] = Execute Address [7 : 0]
```

### A.3.6 COMMAND\_RESET (0x25)

This command is used to tell the flash loader device to reset. This is useful when downloading a new image that overwrote the flash loader and wants to start from a full reset. Unlike the COMMAND\_RUN command, this allows the initial stack pointer to be read by the hardware and set up for the new code. It can also be used to reset the flash loader if a critical error occurs and the host device wants to restart communication with the flash loader.

```
Byte [0] = 3
Byte [1] = checksum (Byte [2] )
Byte [2] = COMMAND_RESET
```

The flash loader responds with an ACK signal back to the host device before actually executing the software reset to the device running the flash loader. This allows the host to know that the command was received successfully and the part will be reset.

# Ordering and Contact Information

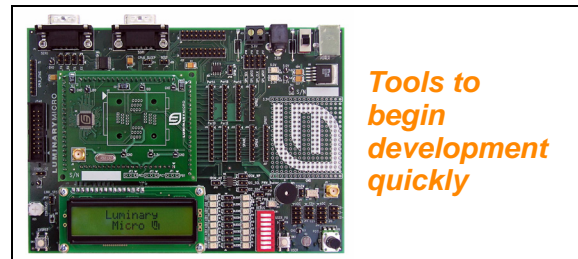
## Ordering Information

| Order Number                  | Features   |           |                    |                     |                    |                      |         |     |                  |                      |                  |          |     |                                    |                      |                                |
|-------------------------------|------------|-----------|--------------------|---------------------|--------------------|----------------------|---------|-----|------------------|----------------------|------------------|----------|-----|------------------------------------|----------------------|--------------------------------|
|                               | Flash (KB) | SRAM (KB) | GPIOs <sup>a</sup> | Timers <sup>b</sup> | ADC                |                      | UART(s) | SSI | I <sup>2</sup> C | Analog Comparator(s) | PWM <sup>c</sup> |          | QEI | Operating Temperature <sup>d</sup> | Package <sup>e</sup> | Speed (Clock Frequency in MHz) |
|                               |            |           |                    |                     | Samples Per Second | # of 10-Bit Channels |         |     |                  |                      | PWM Pins         | CCP Pins |     |                                    |                      |                                |
| LM3S628-IQN50                 | 32         | 8         | 9 to 28            | 3                   | 1M                 | 8                    | 2       | √   | √                | -                    | -                | 4        | -   | I                                  | QN                   | 50                             |
| LM3S628-IQN50(T) <sup>f</sup> |            |           |                    |                     |                    |                      |         |     |                  |                      |                  |          |     |                                    |                      |                                |

- a. Minimum is number of pins dedicated to GPIO; additional pins are available if certain peripherals are not used. See data sheet for details.
- b. One timer available as RTC.
- c. PWM motion control functionality can be achieved through dedicated motion control hardware (using the PWM pins) or through the motion control features of the general-purpose timers (using the CCP pins). See data sheet for details.
- d. I=Industrial (-40 to 85°C).
- e. QN=48-pin RoHS-compliant PQFP.
- f. T=Tape and Reel.

## Development Kit

The Luminary Micro Stellaris™ Family Development Kit provides the hardware and software tools that engineers need to begin development quickly. Ask your Luminary Micro distributor for part number DK-LM3S828. See the Luminary Micro website for the latest tools available.



## Company Information

Luminary Micro, Inc. designs, markets, and sells ARM Cortex-M3 based microcontrollers for use in embedded applications within the industrial, commercial, and consumer markets. Luminary Micro is ARM's lead partner in the implementation of the Cortex-M3 core. Please contact us if you are interested in obtaining further information about our company or our products.

Luminary Micro, Inc.  
 2499 South Capital of Texas Hwy, Suite A-100  
 Austin, TX 78746  
 Main: +1-512-279-8800  
 Fax: +1-512-279-8879  
<http://www.luminarymicro.com>  
[sales@luminarymicro.com](mailto:sales@luminarymicro.com)

## **Support Information**

For support on Luminary Micro products, contact:

support@luminarymicro.com

+1-512-279-8800, ext. 3