

EX162022 16 characters x 2 lines

Mechanical Data

Item	Standard Value	Unit
Module Dimensions	84.0(W) X 44.0(H) X 10.0 (T)	mm
Viewing Area	62.2(W) X 17.9(H)	mm
Dot Size	0.55(W) X 0.65(H)	mm
Dot Pitch	0.60(W) X 0.70(H)	mm

External Dimensions

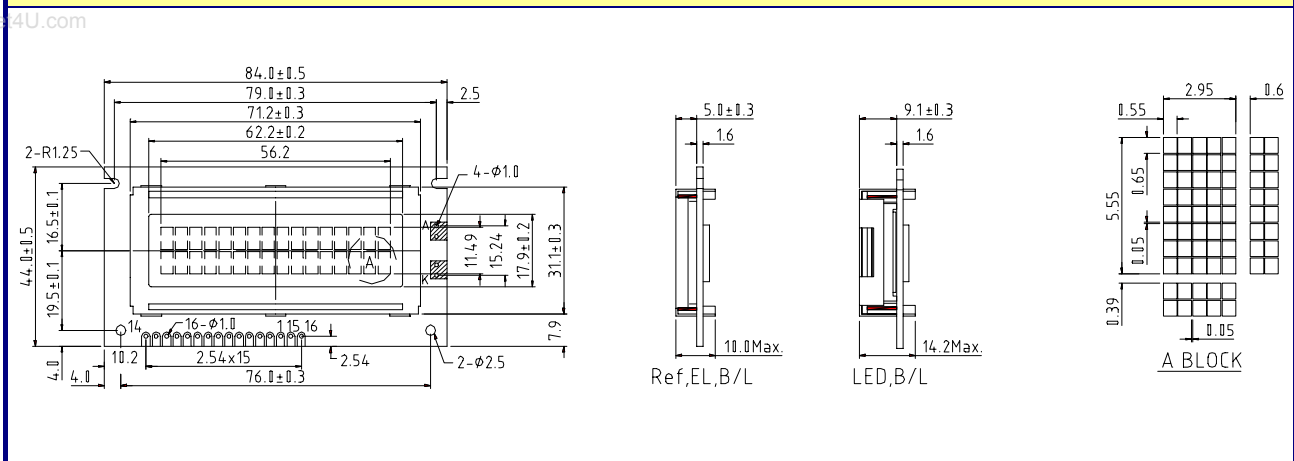

Pin Assignment

No.	Symbol	Function	No.	Symbol	Function
1	V _{SS}	GND,0V	9	DB2	Data Bus Line
2	V _{DD}	+5V	10	DB3	Data Bus Line
3	V _{EE}	For LCD Drive	11	DB4	Data Bus Line
4	RS	Function select	12	DB5	Data Bus Line
5	R/W	Read/Write	13	DB6	Data Bus Line
6	E	Enable signal	14	DB7	Data Bus Line
7	DB0	Data Bus Line	15	LED A	LED power supply
8	DB1	Data Bus Line	16	LED K	LED power supply

Block Diagram

