

# HYBRID LASER DIODE AND DRIVER FOR PULSE OPERATIONS

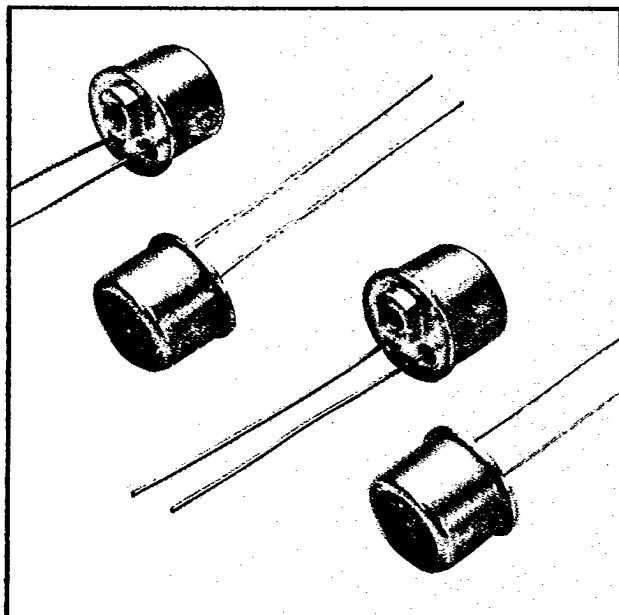

## FEATURES

- ▶ Laser Chip and Driver Electronics in one Hermetic T0-5 type Package
- ▶ High Efficiency Operation
- ▶ Pulse Widths from 10ns to 50ns
- ▶ High Peak Power Emission
- ▶ 904nm Peak Emission Wavelength
- ▶ TTL Compatible
- ▶ Low Voltage Operation (100 Volts Maximum)
- ▶ Other Wavelengths Available

## DESCRIPTION

The model LH- Series incorporates a pulsed laser driver into the same package as the laser diode. The hybridization of the driver permits much narrower pulse widths and faster rise times at lower voltages than with discrete laser drivers.

TTL compatibility permits triggering from most digital circuitry. The LH- Series is compatible with most of LDI standard single diode lasers. The hermetic T0-5 package and increased efficiency is ideal when space and weight are of primary concern.

## CHARACTERISTICS OF A PACKAGED DIODE @ 25°C

PARAMETERS	Symbol	Min.	Typical	Max.	Units
Wavelength of Peak Intensity	$\lambda$	900	904	910	nm
Spectral Width @ 50% Points	$\Delta\lambda$		3.5		nm
Rise Time of Radiant Flux - 10% to 90% pts.	Tr	2		20	ns
Pulse Width - 50% points @ $I_m$	Tp		Tp±5		ns
Storage Temperature	Ts	-55		+100	°C
Operating Temperature	Tc	-55		+ 55*	°C

\*Selected Units to 70°C Available

## ORDERING INFORMATION

# LH60 SERIES, SINGLE HETEROJUNCTION GaAs LASER DIODES

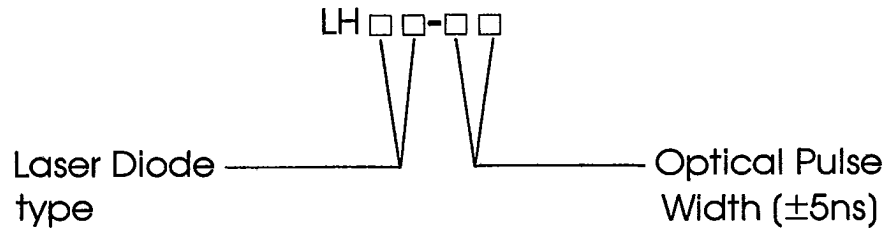
EXAMPLE:

LH60-10

EXPLANATION:

A Laser Hybrid using an LH60 type laser to emit a 10 nanosecond optical pulse at a minimum of 2 watts peak power

## ELECTRO-OPTICAL CHARACTERISTICS OF THE DIODE

PARAMETERS		DIODE TYPE				UNITS
DATA @ 25°C		LH-60	LH-62	LH-65	LH-67	
Total Peak	Min	2	5	10	16	Watts
Radiant Flux	Typ	2.3	6	12	20	Watts
Approximate Emitting Area		3x.08	6x.08	9x.08	16x.08	Mils
Maximum Duty Factor		.1	.1	.1	.1	%
Maximum Voltage Ratings @ Selected Pulsewidths	10ns	50	90	-	-	Volts
	20ns	30	50	90	-	Volts
	30ns	20	25	45	65	Volts
	40ns	15	20	40	60	Volts
	50ns	10	18	35	50	Volts

TYPICAL CHARACTERISTICS

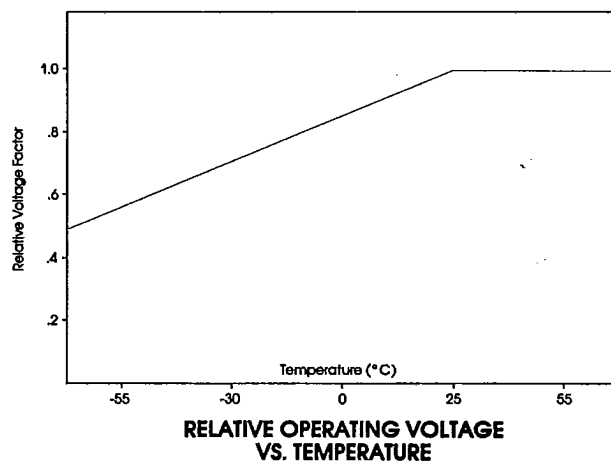
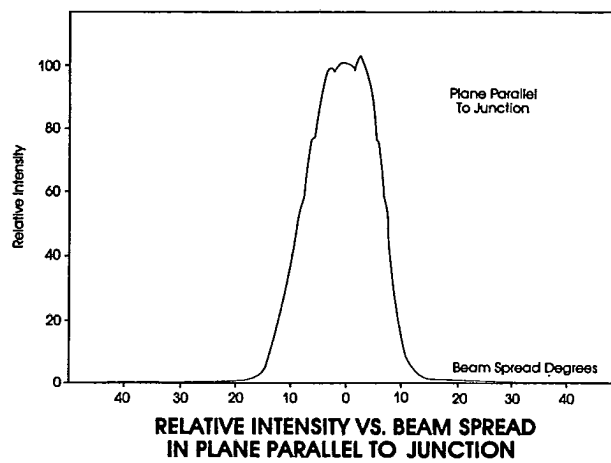
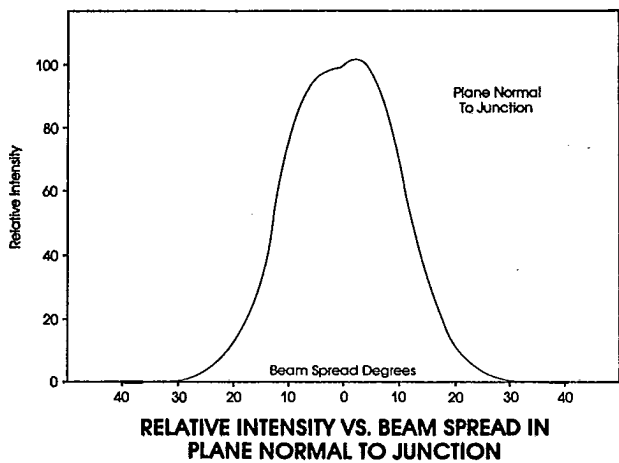
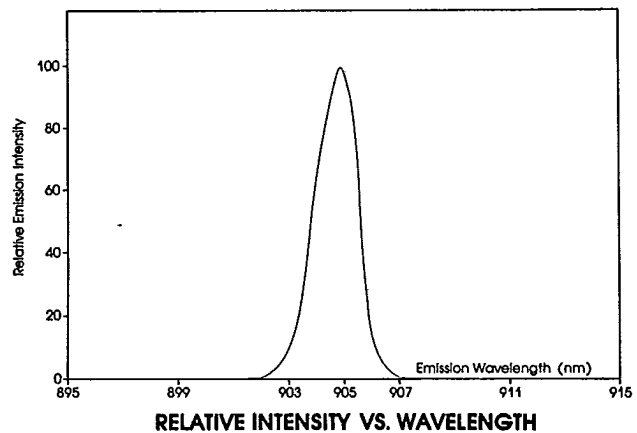
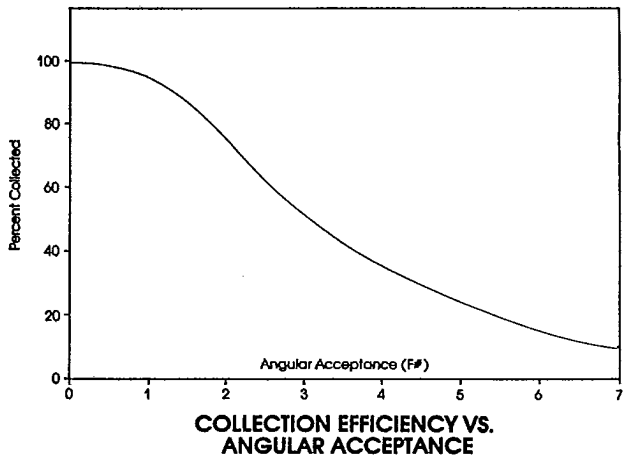

PACKAGE SPECIFICATIONS

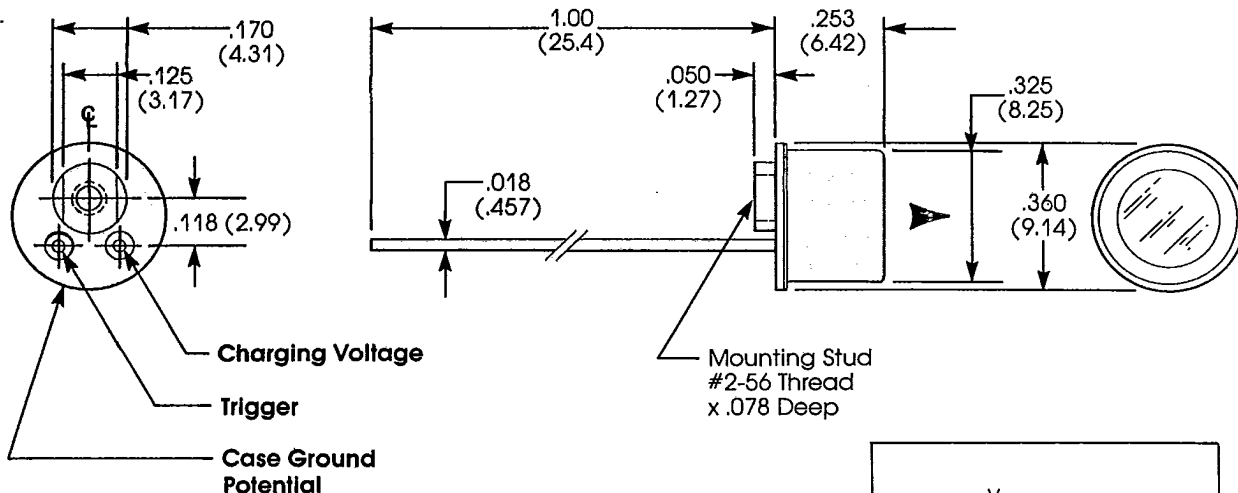

NOTE  
1. Dimensions in inches,  
mm in parenthesis.

**-CAUTION-**  
**INVISIBLE LASER**  
**RADIATION EMITTED**  
**FROM GLASS WINDOW**

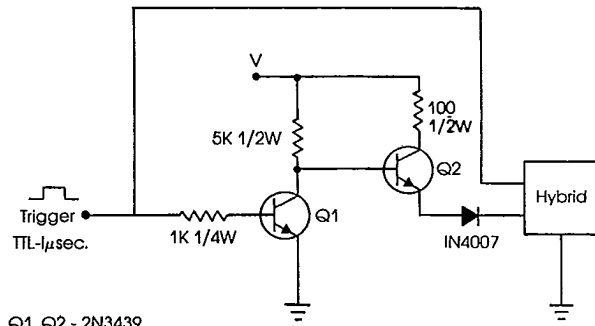

Q1, Q2 - 2N3439

CHARGING CIRCUIT

LASER SAFETY

Gallium arsenide lasers emit infrared radiation which is invisible to the human eye. When in use, safety precautions should be taken to avoid the possibility of eye damage.

Do not stare directly at the device or view an operating laser at close range. If viewing is required, the beam should only be observed by reflection from a matte surface utilizing an image convertor or by use of a suitable fluorescent screen.



<b>LASER DIODE, INC.</b>			
Invisible Laser Radiation emitted from glass window			
Type <b>LH-67</b>	Case	Pkg. <b>T0-5</b>	
V <sub>M</sub> <b>65V</b>	P <sub>0</sub> <b>20W</b>	@ <b>25</b>	°C
V <sub>M</sub>	P <sub>0</sub>	@	°C
λ <b>904 nm</b>	Date of Mfr.		
LASER DIODE, INC. Made in New Brunswick, N.J. U.S.A. This product conforms to DHEW regulation 21 CFR Subchapter J			

LASER DIODE, Inc., reserves the right to make changes at any time as deemed practical and/or necessary to improve the design and to supply the best possible product.

Information provided is believed at this time to be accurate and reliable. No responsibility is assumed for its use, nor for any infringements on the rights of others.

\*For further information on this product or others of LASER DIODE, Inc., please call;



**LASER DIODE, INC.**  
MORGAN ELECTRONICS DIVISION  
1130 SOMERSET ST., NEW BRUNSWICK, NJ 08901  
(201) 249-7000 (FAX) 201-249-9165 (TWX) 710-998-0597