



# LITHIUM ION BATTERY CHARGER USING C8051F300

## Relevant Devices

This application note applies to the following devices:  
C8051F300

## Introduction

Driven by the need for untethered mobility and ease of use, many systems rely on rechargeable batteries as their primary power source. The battery charging circuitry for these systems is typically implemented using a fixed-function IC to control the charging current/voltage profile.

The C8051F30x family provides a flexible alternative to fixed-function battery chargers. This application note discusses how to use the C8051F30x family in Li-Ion battery charger applications. The Li-Ion charging algorithms can be easily adapted to other battery chemistries, but an understanding of other battery chemistries is required to ensure proper charging for those chemistries.

## Key Points

- On-chip high-speed, 8-bit ADC provides superior accuracy in monitoring charge voltage (critical to prevent overcharging in Li-Ion applications), maximizing charge effectiveness and battery life.
- On-chip PWM provides means to implement buck converter with a very small external inductor.
- On-chip Temp sensor provides an accurate and stable drive voltage for determining battery temperature. An external RTD (resistive temperature device) can also be used via the flexible analog input AMUX.
- A single C8051F30x platform provides full product range for multi-chemistry chargers, expediting time to market and reducing inventory.

Figure 1. Lithium Ion Battery Charge Block Diagram.

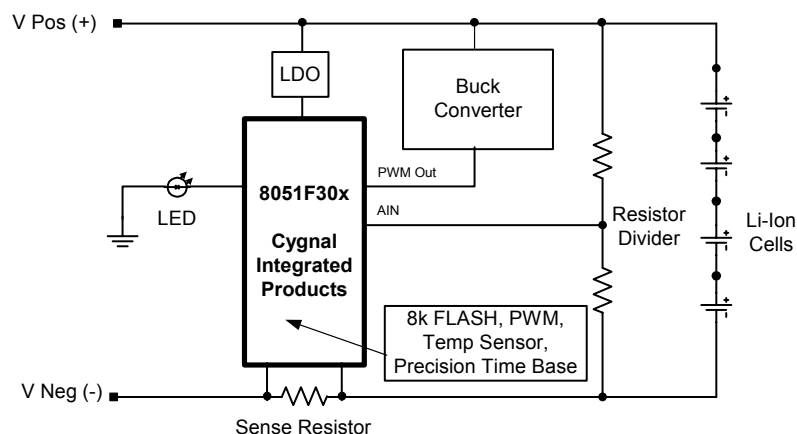

## Charging Basics

Batteries are exhaustively characterized to determine safe yet time-efficient charging profiles. The optimum charging method for a battery is dependent on the battery's chemistry (Li-Ion, NiMH, NiCd, SLA, etc.). However, most charging strategies implement a 3-phase scheme:

1. Low-current conditioning phase
2. Constant-current phase
3. Constant-voltage phase/charge termination

All batteries are charged by transferring electrical energy into them (refer to the references at the end of this note for a battery primer). The maximum charge current for a battery is dependent on the battery's rated capacity (C). For example, a battery with a cell capacity of 1000mAh is referred to as being charged at 1C (1 times the battery capacity) if the charge current is 1000mA. A battery can be charged at 1/50C (20 mA) or lower if desired. However, this is a common trickle-charge rate and is not practical in fast charge schemes where short charge-time is desired.

Most modern chargers utilize both trickle-charge and rated charge (also referred to as bulk charge) while charging a battery. The trickle-charge current is usually used in the initial phases of charging to minimize early self heating which can lead to premature charge termination. The bulk charge is usually used in the middle phase where the most of the battery's energy is restored.

During the final phase of battery charge, which generally takes the majority of the charge time, either the current or voltage or a combination of both are monitored to determine when charging is complete. Again, the termination scheme depends on the battery's chemistry. For instance, most Lithium Ion battery chargers hold the battery voltage constant, and monitor for minimum current. NiCd

batteries use a rate of change in voltage or temperature to determine when to terminate.

Note that while charging a battery, *most* of the electrical energy is stored in a chemical process, but not *all* as no system is 100 percent efficient. Some of the electrical energy is converted to thermal energy, heating up the battery. This is fine until the battery reaches full charge at which time *all* the electrical energy is converted to thermal energy. In this case, if charging isn't terminated, the battery can be damaged or destroyed. Fast chargers (chargers that charge batteries fully in less than a couple hours) compound this issue, as these chargers use a high charge current to minimize charge time. As one can see, monitoring a battery's temperature is critical (especially for Li-Ion as they explode if over-charged). Therefore, the temperature is monitored during all phases. Charge is terminated immediately if the temperature rises out of range.

## Li-Ion Battery Charger - Hardware

Currently, Li-Ion batteries are the battery chemistry of choice for most applications due to their high energy/space and energy/weight characteristics when compared to other chemistries. Most modern Li-Ion chargers use the tapered charge termination, minimum current (see Figure 2), method to ensure the battery is fully charged as does the example code provided at the end of this note.

### *Buck Converter*

The most economical way to create a tapered termination charger is to use a buck converter. A buck converter is a switching regulator that uses an inductor and/or a transformer (if isolation is desired), as an energy storage element to transfer energy from the input to the output in discrete packets (for our example we use an inductor; the capacitor in Figure 3 is used for ripple reduction). Feedback circuitry regulates the energy transfer via the transistor, also referred to as the pass switch, to maintain a constant voltage or constant current

Figure 2. Lithium Ion Charge Profile.

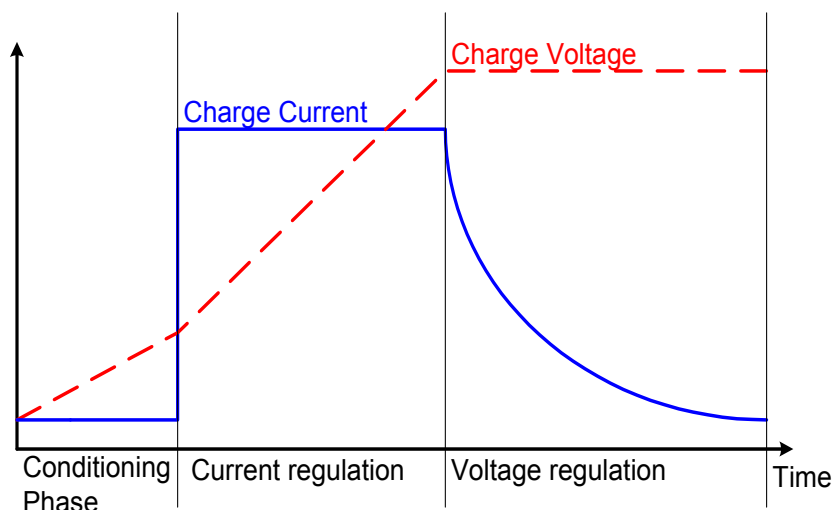

within the load limits of the circuit. See Figure 3 for details.

#### *Tapered Charger Using the F30x*

Figure 3 illustrates an example buck converter using the 'F30x. The pass switch is controlled via the on-chip 8-bit PWM (Pulse Width Modulator) output of the PCA. When the switch is on, current will flow like in Figure 3A. The capacitor is charged from the input through the inductor. The inductor is also charged. When the switch is opened (Figure 3B), the inductor will try to maintain its current flow by inducing a voltage as the current through an inductor can't change instantaneously. The current then flows through the diode and the inductor charges the capacitor. Then the cycle repeats itself. On a larger scale, if the duty cycle is decreased (shorter "on" time), the average

voltage decreases and vice versa. Therefore, controlling the duty cycles allows one to regulate the voltage or the current to within desired limits.

#### *Selecting the Buck Converter Inductor*

To size the inductor in the buck converter, one first assumes a 50 percent duty cycle, as this is where the converter operates most efficiently.

Duty cycle is given by Equation 1, where T is the period of the PWM (in our example  $T = 10.5\mu\text{s}$ ).

$$\text{DutyCycle} = \frac{t_{\text{on}}}{T}$$

Equation 1. Duty Cycle.

Figure 3. Buck Converter.

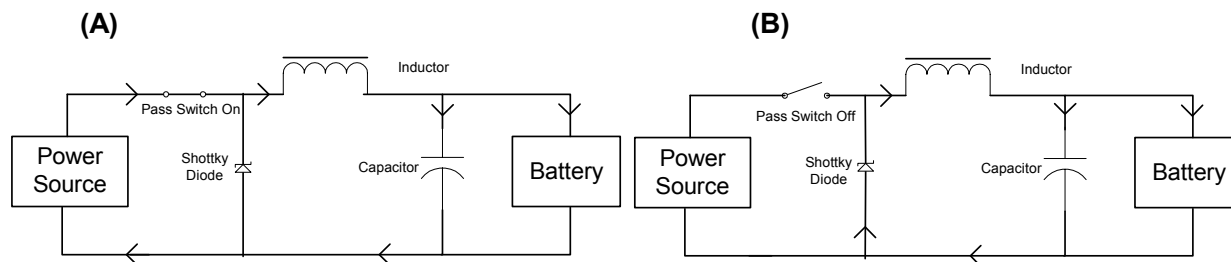

With this established, select a PWM switching frequency. As [Equation 2](#)

$$L = \frac{(V_i - V_{sat} - V_o) t_{on}}{2I_{0max}}$$

**Equation 2. Inductor Size.**

shows, the larger the PWM switching frequency, the smaller (and more cost effective) the inductor. Our example code configures the ‘F30x’s 8-bit hardware PWM to use the internal master clock of 24.5MHz divided by 256 to generate a 95.7kHz switch rate.

Now we can calculate the inductor’s size. Assuming  $V_i$ , the charging voltage, is 15V,  $V_{sat}$ , the saturation voltage, is 0.5V, the desired output voltage,  $V_o$ , is 4.2V, and  $I_{0MAX}$ , the maximum output current, is 1500 mA, the inductor should be at least 18 $\mu$ H.

Note that the capacitor in this circuit is simply a ripple reducer. The larger it is the better as ripple is inversely proportional to the size of the cap. For more details on buck converters, refer to the references listed at the end of this note.

## Li-Ion Battery Charger - Software

The software example that follows demonstrates a Li-Ion battery charger using the C8051F300. The F300 is designed for high-level languages like “C” and includes an 8-bit 8051 based micro-controller, an 8-bit 500 kbps ADC, 8k FLASH, an 8-bit and 16-bit PWM, and a 2% accurate oscillator all on-chip. The algorithms discussed are written entirely in “C” making them easily portable. Refer to the F300’s datasheet for a full description of the device.

### *Calibration*

To ensure accurate voltage and current measurements, the algorithms use a two-point system calibration scheme. In this scheme, the user is expected to apply two known voltages and two known currents, preferable, one point near ground and the other point near full-scale. The algorithm then takes these two points, calculates a slope and an offset for both the current and voltage channels, and stores the results in FLASH. All future conversions are scaled relative to these slope and offset calculations. Note that if an external amplifier is used for the current channel, it will need to be calibrated with a similar two-point calibration scheme to ensure maximum accuracy.

### *Temperature*

To monitor the temperature, the algorithms use the on-chip temperature sensor. The sensor is left uncalibrated, but still provides a sufficiently accurate temperature measurement. For more accurate temperature measurement, one or two-point temperature calibration is required.

An external temperature sensor can be used if desired. The AMUX can to be reconfigured to accommodate this additional input voltage.

### *Current*

The charge-current to the battery cells is monitored by taking a differential voltage reading across a small but accurate sense resistor. The current is amplified through the on-chip PGA, digitized by the on-chip 8-bit ADC, and scaled accordingly via the slope and offset calibration coefficients. An external gain stage may be necessary if more resolution is desired for the current measurement.

### *Voltage*

The battery’s voltages are divided down and monitored via external resistors. Note that this example uses the supply voltage as the ADC voltage reference. Any monitored voltage above the reference voltage must be divided down for accurate moni-

toring. If a more accurate reference is required, an external voltage reference can be used. Adjustment to the divide resistors must be made accordingly.

### *Charging - Phase 1*

In phase 1, (for description purposes, we assume the battery is initially discharged), the 'F30x regulates the battery's current to  $I_{\text{LOWCURRENT}}$  (typically 1/50 C) until the battery's voltage reaches  $V_{\text{MINVOLT BULK}}$ . Note that the battery's charge current is current limited to  $I_{\text{LOWCURRENT}}$  to ensure safe initial charge and to minimize battery self-heating. If at any time the temperature increases out of limit, charging is halted.

### *Charging - Phase 2*

Once the battery reaches  $V_{\text{MINVOLT BULK}}$  the charger enters phase 2, where the battery's algorithm controls the PWM pass switch to ensure the output voltage provides a constant charge-current  $I_{\text{BULK}}$  to the battery (rate or bulk current is usually 1C and is definable in the header file as is  $I_{\text{LOWCURRENT}}$  and  $V_{\text{MINVOLT BULK}}$ ).

### *Charging - Phase 3*

After the battery reaches  $V_{\text{Top}}$  (typically 4.2 V in single cell charger), the charger algorithm enters phase 3, where the PWM feeds back and regulates the battery's voltage. In phase 3, the battery continues to charge until the battery's charge current reaches  $I_{\text{MINIBULK}}$ , after which, the battery is charged for an additional 30 minutes and then charge terminates. Phase 3 typically takes the majority of the charging time.

Note that in most practical applications, such as a portable PC, the batteries may be in any of the three phases when charging is activated. This doesn't really affect the charger as it simply monitor's the

battery's current condition and starts charging from that point.

## Conclusion

The C8051F300's high level of analog integration, small form-factor, integrated FLASH memory, and low power consumption makes it ideal for flexible next generation battery charging applications. This application note discussed how to use the C8051F30x family in Lithium Ion battery charger applications. Example code is provided as well.

## References

**Maxim Integrated Product**, "DC-DC Converter Tutorial".

**Martinez, Carlos and Drori, Yossi and Ciancio, Joe**, "AN126 Smart Battery Primer", Xicor, October 1999.





Figure 5. 1 Cell Buck Converter Schematic.

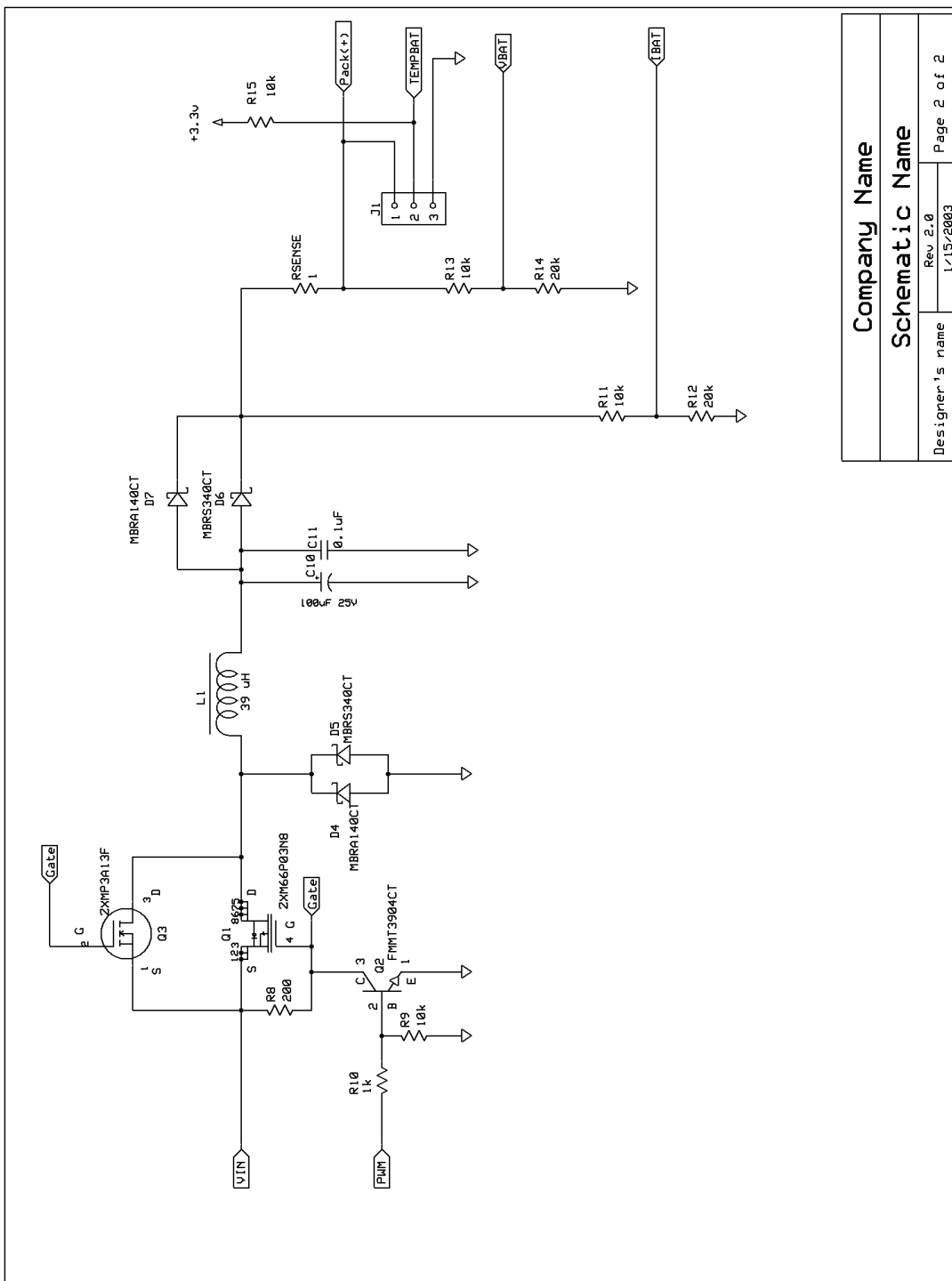

**Figure 6. main() Flow Chart.**

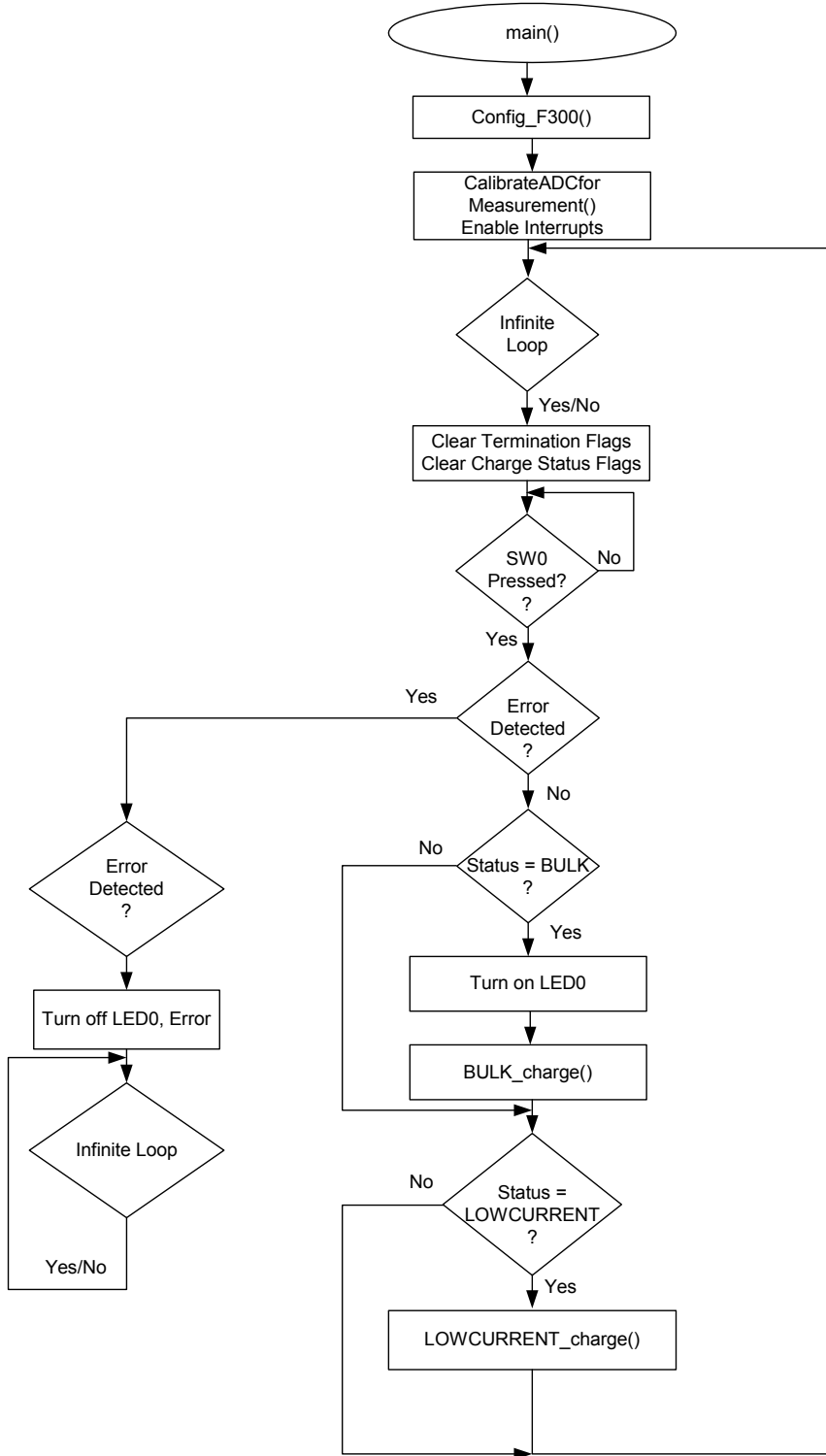



Figure 7. CalibrateADCforMeasurement() Flow Chart.

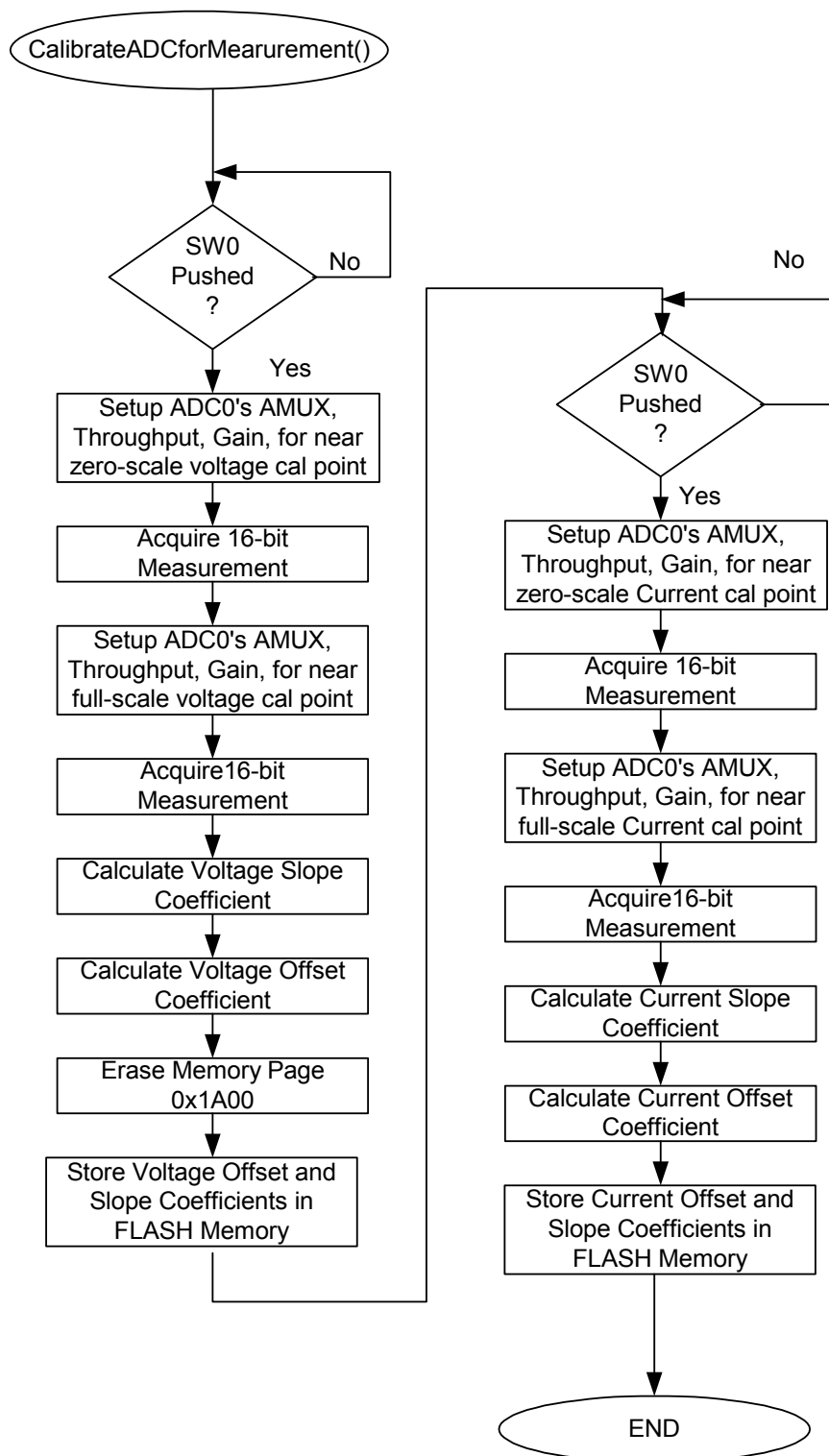

Figure 8. Monitor\_Battery() Flow Chart.

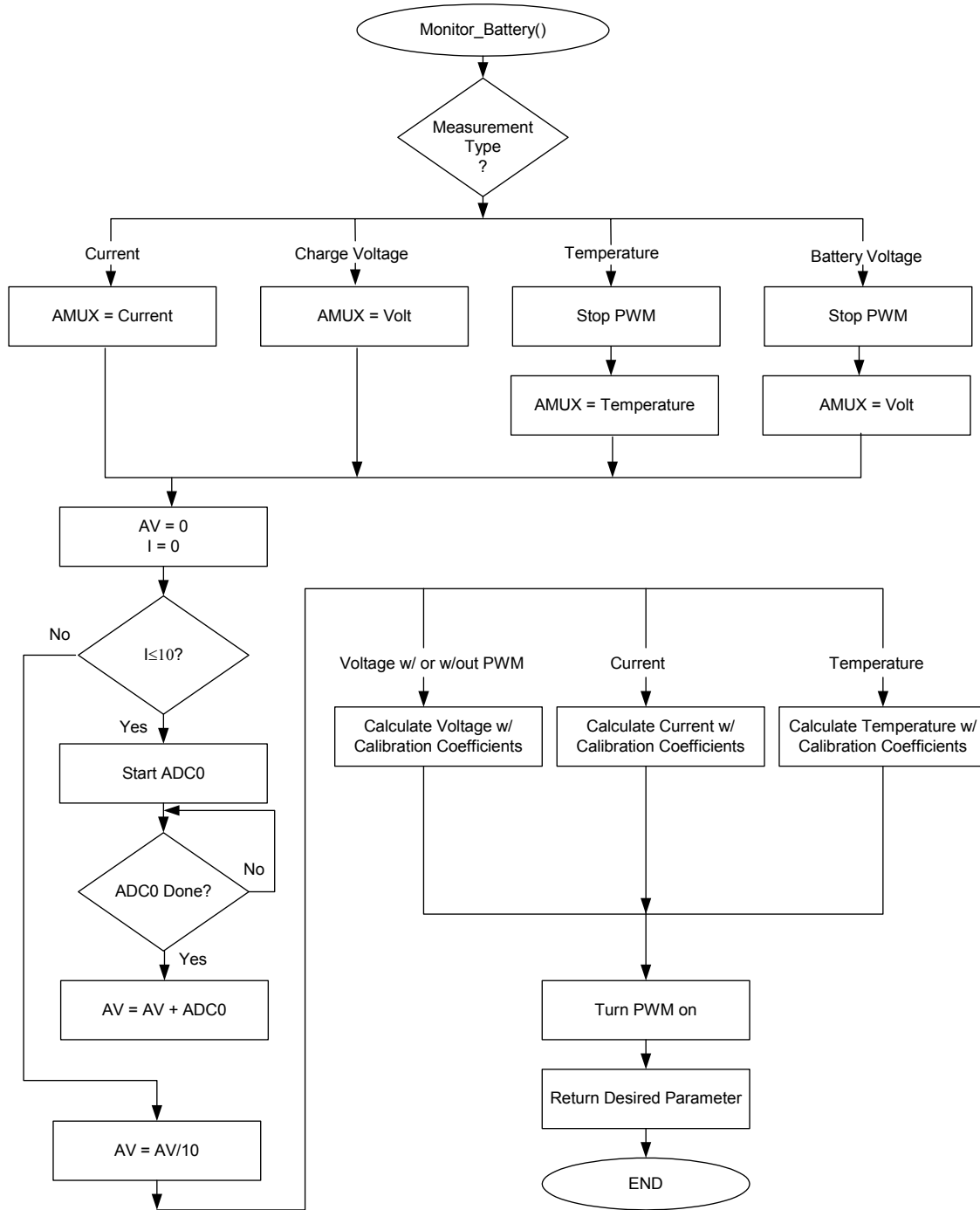

Figure 9. Bulk\_Charge() Flow Chart (Part 1).

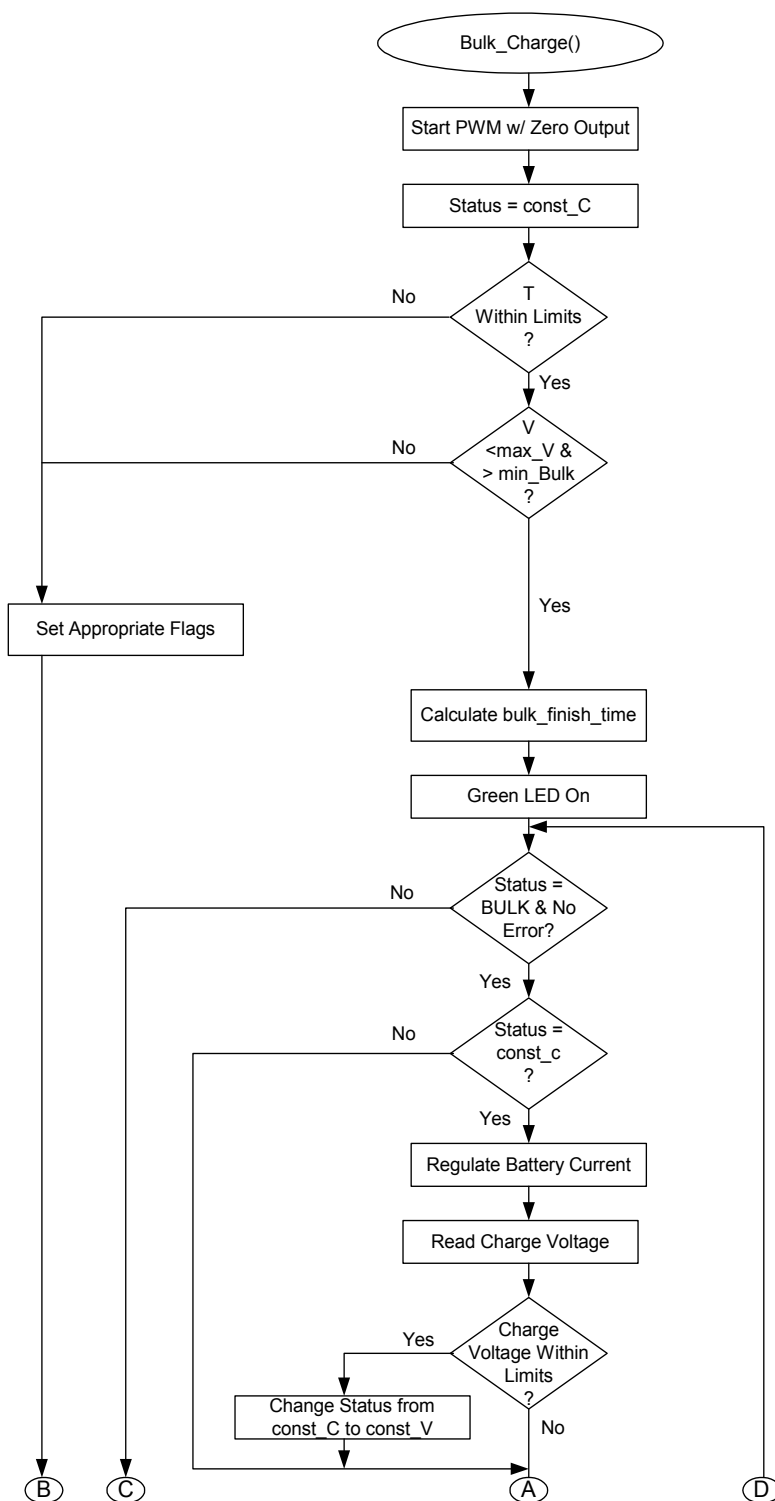

Figure 10. BULKCurrent() Flow Chart (Part 2).

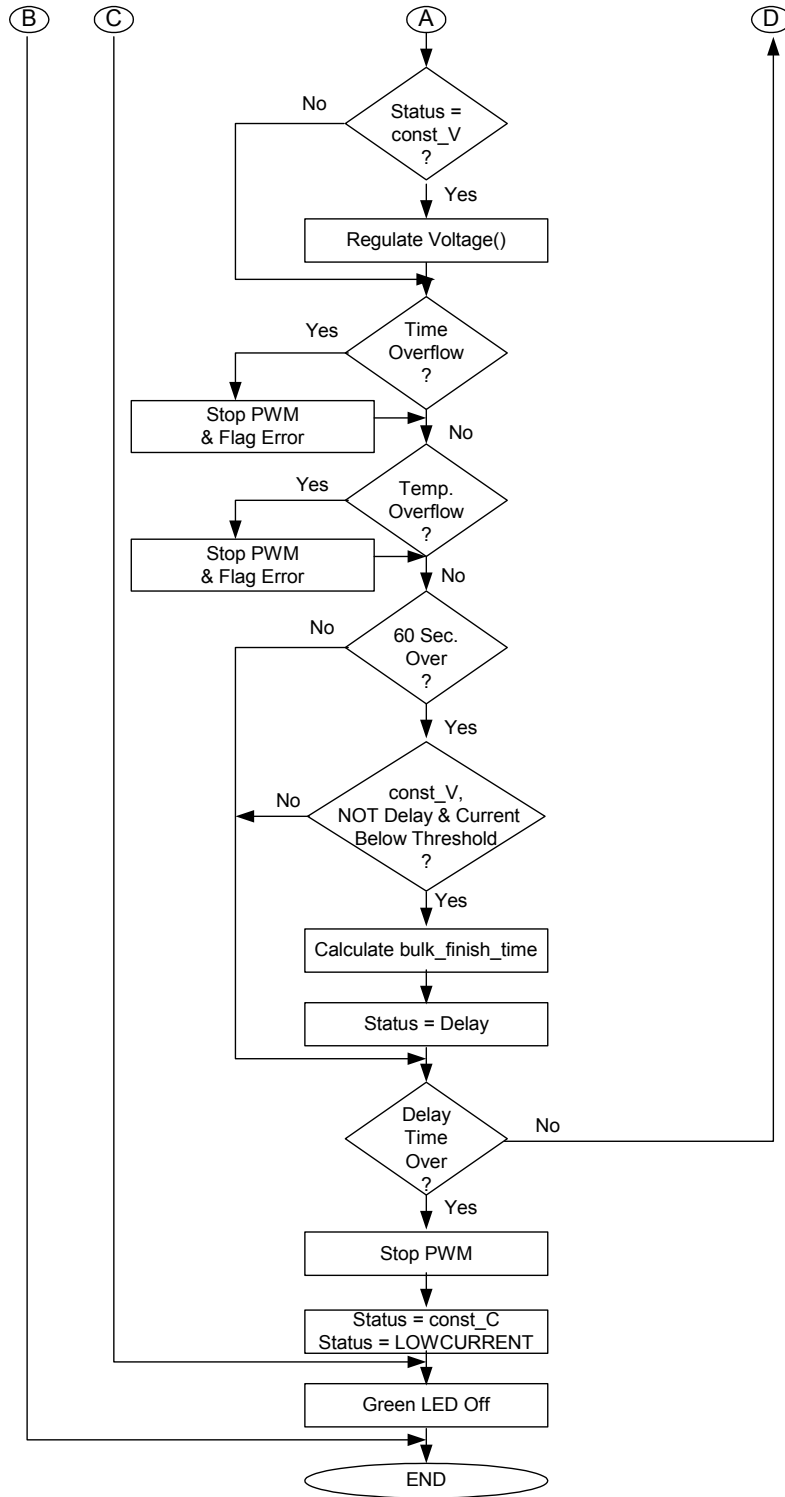

Figure 11. LowCurrent\_Charge() Flow Chart.

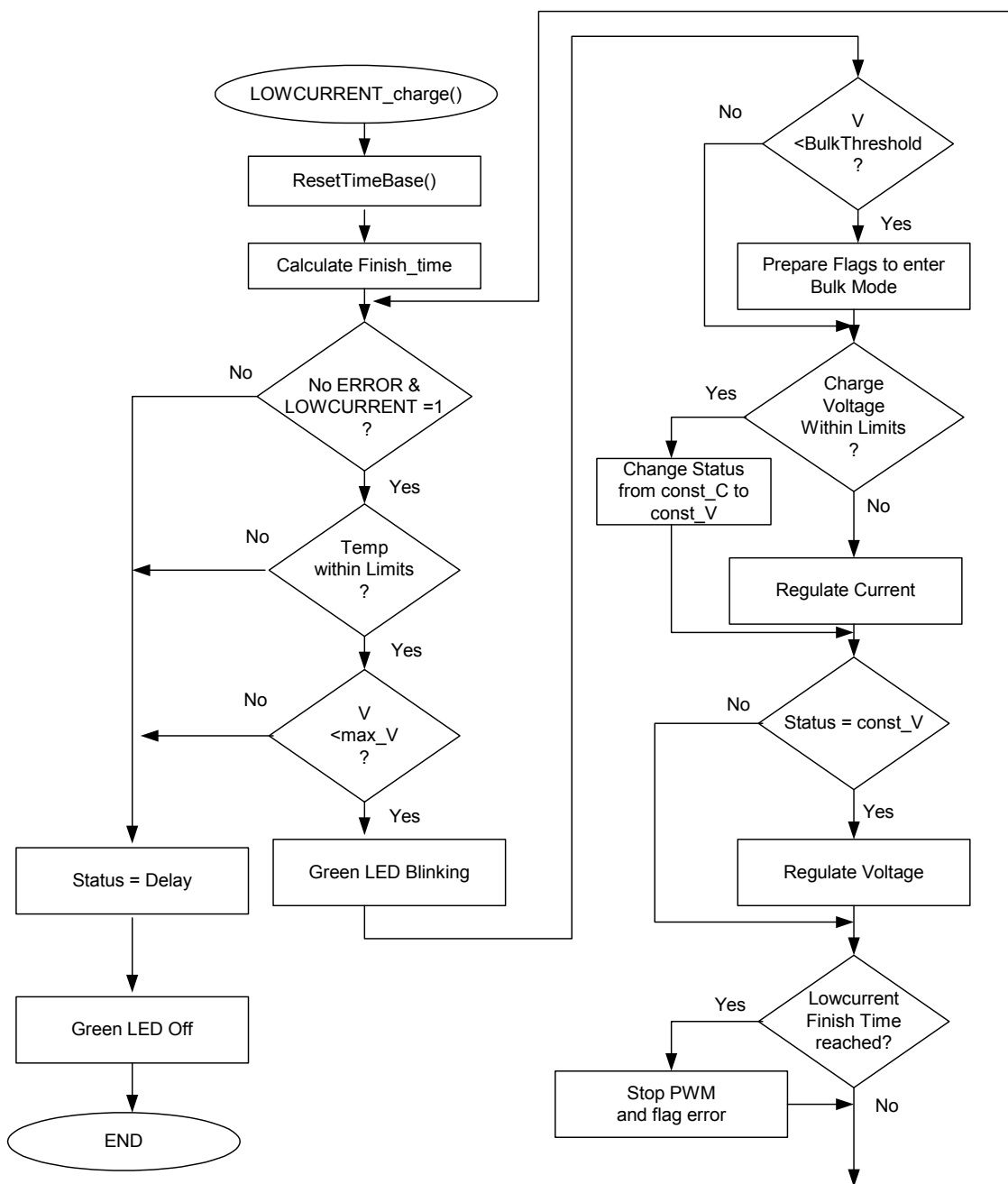

Figure 12. Turn\_PWM\_Off() Flow Chart.

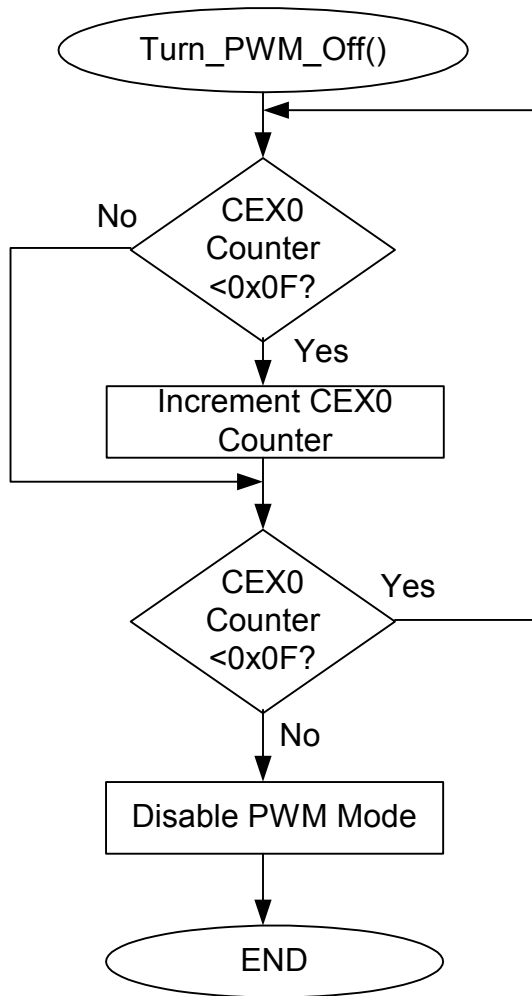

Figure 13. Measure() Flow Chart.

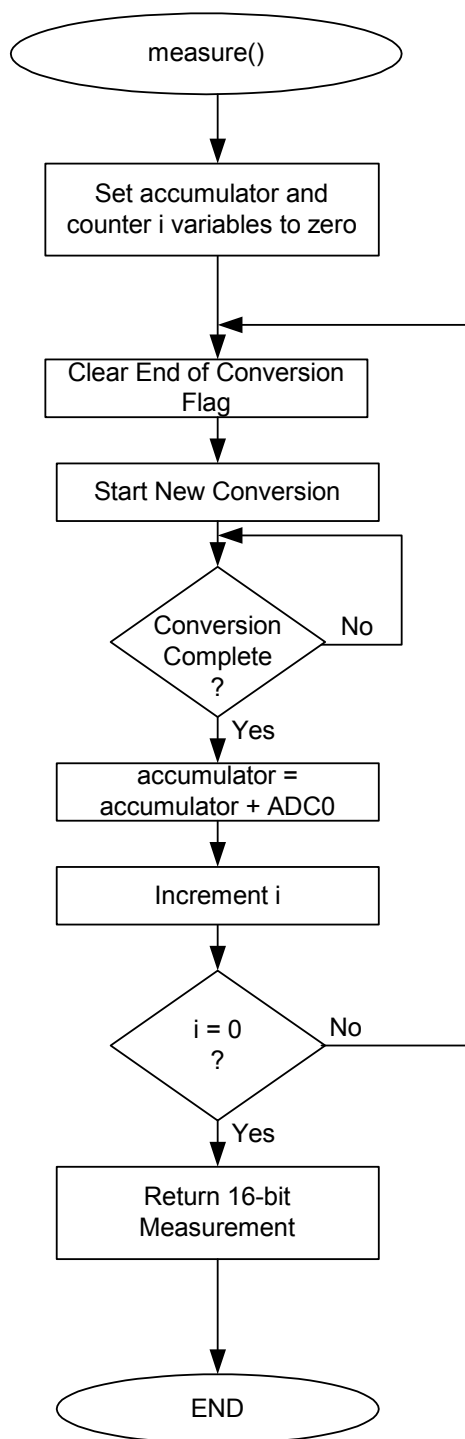

Figure 14. Regulate\_Voltage() Flow Chart.

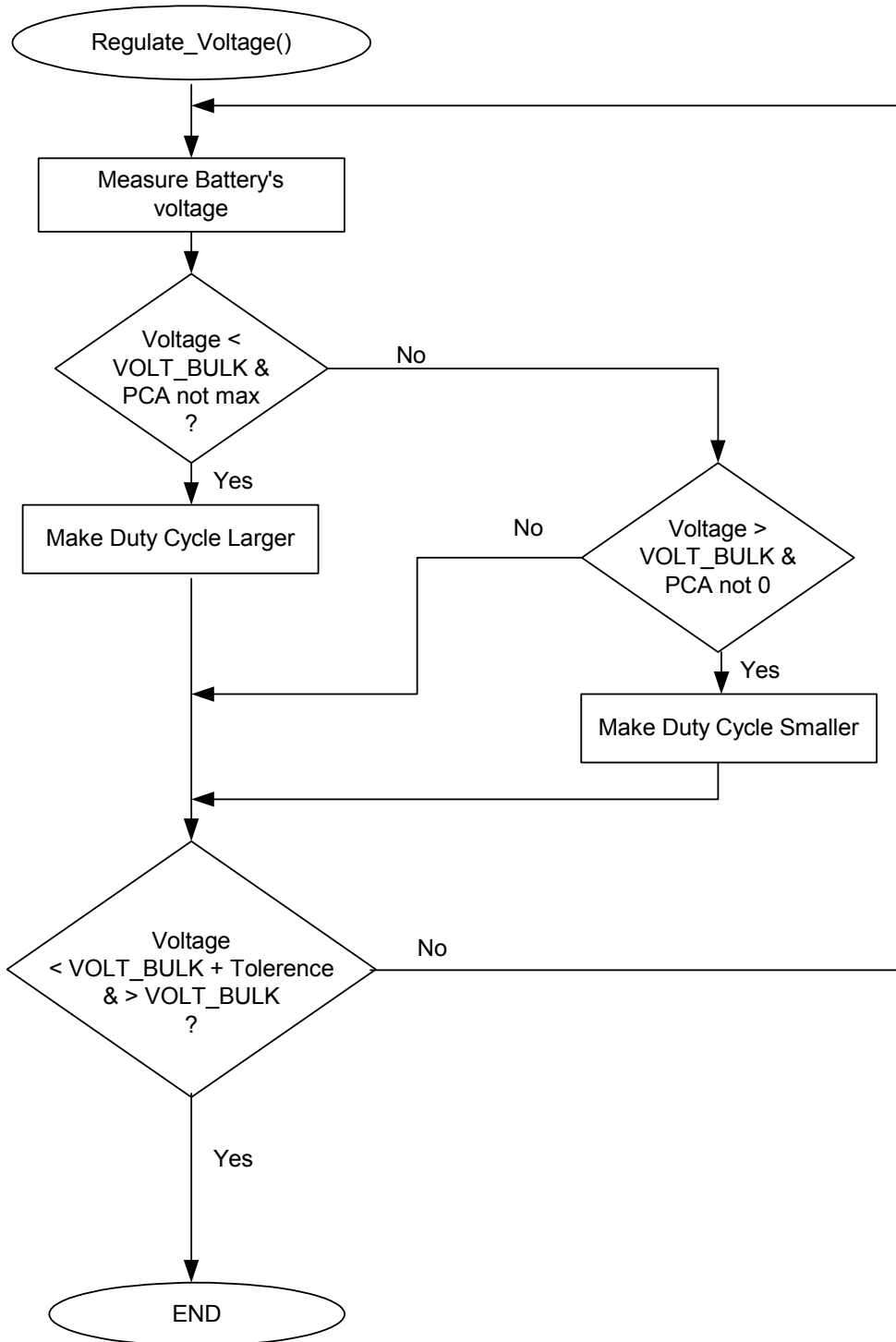



Figure 15. Regulate\_Current() Flow Chart.

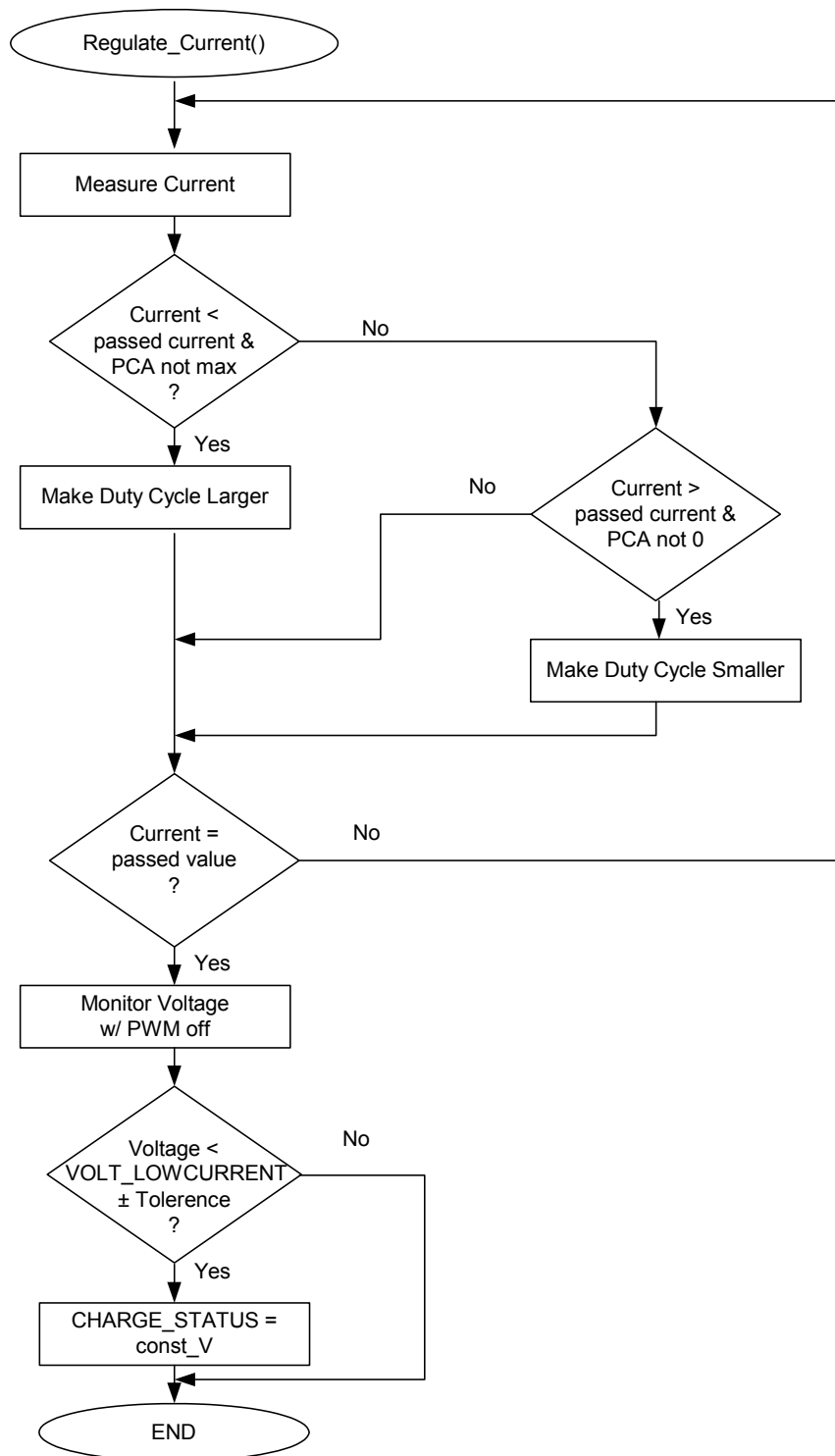
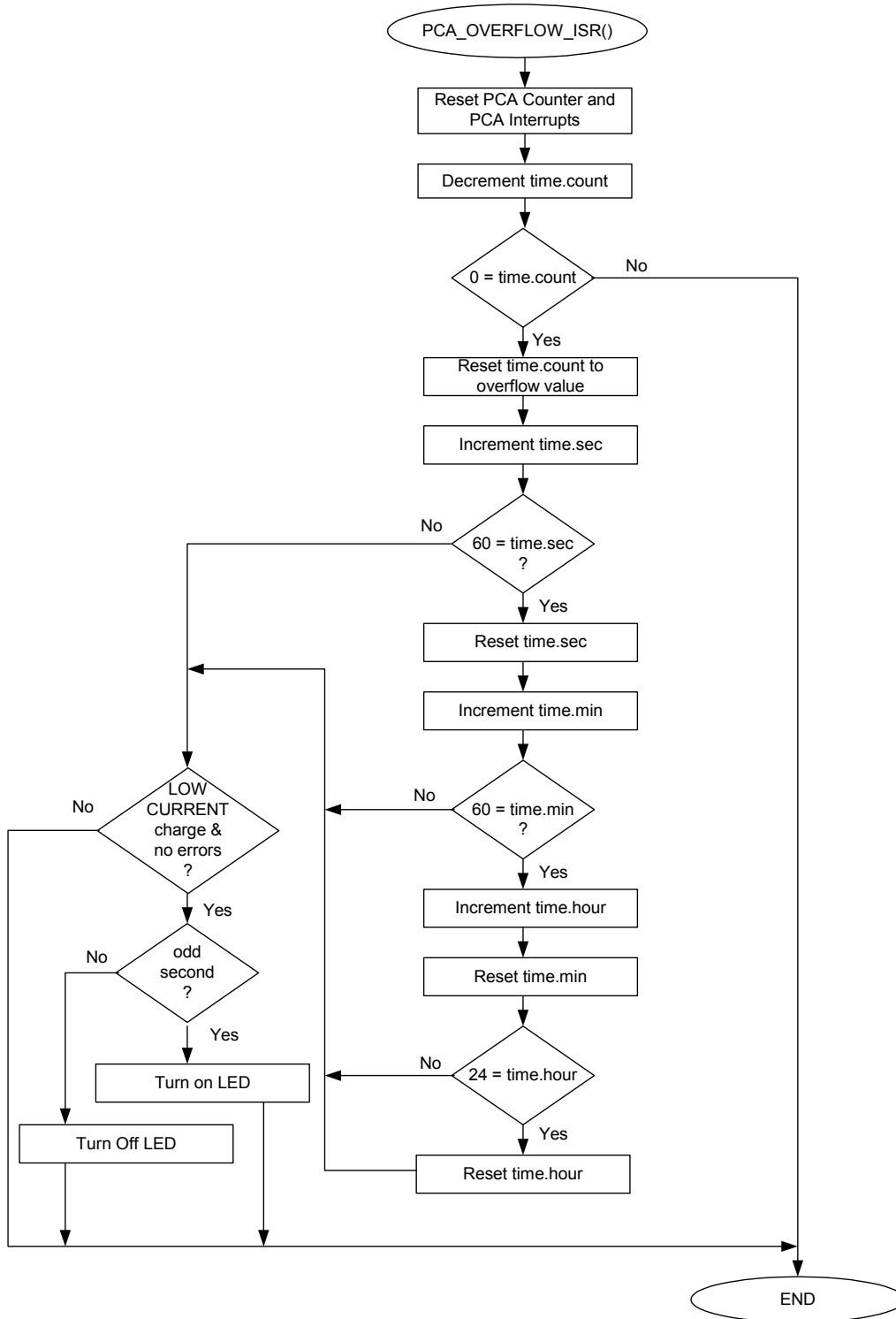

Figure 16. PCA\_OVERFLOW\_ISR() Flow Chart.



```
//-----  
//  
// Copyright 2002 Cygnal Integrated Products, Inc.  
//  
// Filename:      LIION_BC_MAIN.h  
// Target Device: 8051F300  
// Created:       11 SEP 2002  
// Created By:    DKC  
// Tool chain:   KEIL Eval C51  
//  
// This header file is used to define all preprocessor directives, prototypes,  
// and global variable for LIION_BC_MAIN.c.  
//  
// The user should modify this header file before proceeding as key  
// battery parameter limits are set here.  
//  
  
//-----  
// Function Prototypes  
//-----  
void Config_F300(void);  
void Reset_Time_Base(void);  
void CalibrateADCforMeasurement(void);  
void Regulate_Current(int);  
void Regulate_Voltage(void);  
void Turn_PWM_Off(void);  
int  Monitor_Battery(unsigned char);  
void Bulk_Charge(void);  
void Lowcurrent_Charge(void);  
unsigned int Measure(void);  
void Delay_Loop(void);  
  
//-----  
// UNIONS, STRUCTUREs, and ENUMs  
//-----  
typedef union LONG {                // byte-addressable LONG  
    long l;  
    unsigned char b[4];  
} LONG;  
  
typedef union INT {                 // byte-addressable INT  
    int i;  
    unsigned char b[2];  
} INT;  
  
typedef struct  
{  
    unsigned long int t_count;  
    int sec;                // global seconds  
    int min;                // global minutes  
    int hour;               // global hour  
}time_struct;  
  
  
//-----  
// Global Variable Definitions
```

# AN137

```
//-----  
time_struct TIME; // Global Struct to Track Time  
char bdata TERMINATION; // Global Variable to Track Termination  
char bdata CHARGE_STATUS; // Global Variable to Track Charging  
INT code CHECK_BYTE _at_ 0x1A00; // 0x0A0A Default value, for later use  
LONG code VOLT_SLOPE _at_ 0x1A60; // Volt Slope Register  
LONG code VOLT_OFFSET _at_ 0x1A64; // Volt Offset Register  
LONG code I_NOAMP_SLOPE _at_ 0x1A70; // Current Slope Register,ext. amp off  
LONG code I_NOAMP_OFFSET _at_ 0x1A74; // Current Offset Register,ext. amp.off  
LONG temp_LONG_1,temp_LONG_2; // Temporary Storage Variables  
INT temp_INT_1,temp_INT_2; // Temporary Storage Variables  
  
//-----  
// Bit maskable CHARGE STATUS Register Definition  
//-----  
sbit BULK = CHARGE_STATUS^0; // bit 0 : BULK charge status bit  
sbit LOWCURRENT = CHARGE_STATUS^1; // bit 1 : LOWCURRENT charge status bit  
sbit ERROR = CHARGE_STATUS^2; // bit 2 : ERROR before/during charging  
sbit CONST_V = CHARGE_STATUS^3; // bit 3 : charged w/ constant VOLTAGE  
sbit CONST_C = CHARGE_STATUS^4; // bit 4 : charged w/ constant CURRENT  
sbit DELAY = CHARGE_STATUS^5; // bit 5 : BULK charge DELAY for LiIon  
// after CURRENT threshold detection  
sbit READY = CHARGE_STATUS^6; // bit 6 : Lowcurrent charge is  
// terminated; battery is charged  
sbit FREE1 = CHARGE_STATUS^7; // bit 7 : Not Currently used  
  
//-----  
// Bit Maskable TERMINATION Register Definition  
//-----  
sbit TEMP_MIN = TERMINATION^0; // bit 0 : minimum TEMPERATURE overflow  
sbit TEMP_MAX = TERMINATION^1; // bit 1 : maximum TEMPERATURE overflow  
sbit I_MIN = TERMINATION^2; // bit 2 : minimum CURRENT overflow  
sbit I_MAX = TERMINATION^3; // bit 3 : maximum CURRENT overflow  
sbit TIME_MAX = TERMINATION^4; // bit 4 : maximum time overflow  
sbit VOLT_MAX = TERMINATION^5; // bit 5 : maximum VOLTAGE overflow  
sbit VOLT_MIN = TERMINATION^6; // bit 6 : minimum VOLTAGE overflow  
sbit FREE2 = TERMINATION^7; // bit 7 : Not Currently used  
  
//-----  
// Bit maskable PORT Definitions  
//-----  
sbit SDA = P0 ^ 0; // bit 0 : SDA In/Output, Pin P0.  
sbit SCL = P0 ^ 1; // bit 1 : SCL Output, Pin P1.  
sbit CEX0 = P0 ^ 2; // bit 2 : PWM Output, Pin P2.  
sbit LED0 = P0 ^ 3; // bit 3 : LED0, Pin P0.3  
sbit SW0 = P0 ^ 7; // bit 7 : Switch0, Pin P0.7  
  
// AMUX Selections; Analog Inputs  
#define TBAT 0xF8; // bit 4 : Temp. Ch.; Analog In  
#define IBAT 0x65; // bit 5 : Current Ch.; Analog In  
#define VBAT 0xF6; // bit 6 : Voltage Ch.; Analog In  
  
//-----  
// 8051F300 PARAMETERS  
//-----  
#define SYSCLK 2450000 // System clock frequency
```

```

#define TEMP_SENSOR_GAIN 3300 // Temp Sensor Gain in (uV / degC)
#define TEMP_GAIN 2 // PGA gain setting
#define CURRENT_GAIN 4 // PGA gain setting
#define VREF 3200 // ADC Voltage Reference (mV)
#define SCRATCH_PAGE 0x1C00 // FLASH page used for temp storage
#define PWM_CLOCK SYSCLK/255 // PWM frequency is 96 kHz

//-----
// Calibration/Calculation PARAMETERS
//-----
#define V1_CAL 67 // 1st cal point for 2 point cal.
#define V2_CAL 2800 // 2nd cal point for 2 point cal.
#define I1_CAL 67 // 1st cal point for 2 point cal.
#define I2_CAL 133 // 2nd cal point for 2 point cal.
#define RSENSE 1 // RSENSE is assumed to be 1/2 ohm
#define RESB 20 // 10k Ohms, Voltage Divide Resistor
#define RESAB 30 // 20k Ohms, Voltage Divide Resistor

#define TEMP_SLOPE ((long) TEMP_GAIN * TEMP_SENSOR_GAIN * 65536 / 100 / VREF)
// An estimate of the Temperature<SLOPE>
// in [tenth codes / K]
// The temperature measurement is
// within 3 degrees of accuracy.

//-----
// Monitor_Battyer Switch PARAMETERS
//-----
#define TEMPERATURE 7 // Value for Switch Statement
#define VOLTAGE 5 // Value for Switch Statement
#define VOLTAGE_PWM_OFF 3 // Value for Switch Statement
#define CURRENT 1 // Value for Switch Statement

//-----
// Battery/Pack Parameters
//-----
#define CELLS 1 // Number of cells in the battery pack
#define CAPACITY 150 // mAh, Battery Capacity (LiIon)
#define LiIon_CELL_VOLT 4200 // mV, Nominal Charge Voltage
#define I_BULK (unsigned int)(CAPACITY)
#define I_LOWCURRENT (unsigned int)(CAPACITY/4)
#define VOLT_BULK (unsigned int)(LiIon_CELL_VOLT)

#define VOLT_LOWCURRENT (unsigned int)(LiIon_CELL_VOLT)

#define VOLT_TOLERANCE (unsigned int)(LiIon_CELL_VOLT/100)// 1 Percent Acc
#define CURRENT_TOLERANCE (unsigned int)(CAPACITY/10) // 10 Percent Acc

//-----
// Battery Characteristics: Charge TERMINATION Limits
//-----
#define MIN_TEMP_ABS 26300 // Abs. min. TEMPERATURE = -10 C, 263K
#define MAX_TEMP_ABS 32300 // Abs. max. TEMPERATURE = 50C, 323K:

```



# AN137

---

```
#define MIN_VOLT_BULK      3000      // Minimum BULK Voltage
#define MAX_VOLT_ABS      (unsigned int)(CELLS * LiIon_CELL_VOLT)
#define MIN_I_BULK        (unsigned int)(CAPACITY/4)
#define MAX_TIME_LOWCURRENT 30      // Max Lowcurrent Charge Time = 90min
#define MAX_TIME_BULK     90        // Maximum BULK Charge Time = 90 min
                                   // at 1C CURRENT
#define BULK_TIME_DELAY   30        // DELAY = 30min after "MIN_I_BULK"

// END OF FILE
```

```

//-----
//
// Copyright 2002 Cygnal Integrated Products, Inc.
//
// Filename:      LIION_BC_MAIN.c
// Target Device: 8051F300
// Created:       11 SEP 2002
// Created By:    DKC
// Tool chain:    KEIL Eval C51
//
// This is a stand alone battery charger for a Lithium ION battery.
// It utilizes a buck converter, controlled by the on-chip 8-bit PWM,
// to provide constant current followed by constant voltage battery charge.
//
//-----
// Includes
//-----
#include <c8051f300.h>
#include "LIION_BC_MAIN.h"          // Battery Header File
//-----
// Functions
//-----

void Config_F300(void)
{ RSTSRC   = 0x02;          // Enable VDD Monitor
  XBR0     = 0x70;          // Skip P0.4,5,6; they're analog In
  XBR1     = 0x44;          // Enable SMBus on P0.0, P0.1, and CEX0
  XBR2     = 0x40;          // as PWM at P0.2
                          // Enable crossbar and weak pull-ups

  POMDOUT  = 0x0C;          // Set P0.2 & P0.3 output to push-pull
  POMDIN   = 0x8F;          // Configure P0.4,5,6 as Analog Inputs

  OSCICN   = 0x07;          // Set SYSCLK to 24.5MHz, internal osc.

  ADC0CN   = 0xC0;          // Turn on the ADC Module;
                          // enable low power mode for settling

  REFOCN   = 0x0C;          // Configure ADC's to use VDD for
                          // Voltage Reference,
                          // Enable On-chip Temperature Sensor
//-----
// PCA Configuration
//-----
  PCA0MD   = 0x00;          // Disable WDT
  PCA0MD   = 0x08;          // Set PWM Time base = SYSCLK

  PCA0L    = 0x00;          // Initialize PCA Counter to Zero
  PCA0H    = 0x00;

  PCA0CN   = 0x40;          // Enable PCA Counter
                          // Clear PCA Counter Overflow flag

//Module 0
  PCA0CPM0 = 0x00;          // Configure CCM0 to 8-bit PWM mode
  PCA0CPL0 = 0xF0;          // Initialize PCA PWM to small duty cycle
  PCA0CPH0 = 0xF0;          // 0xF0 Ensures a Soft Initial Charge

```



# AN137

---

```
//Module 1
PCA0CPM1 = 0x49;           // Configure Module 1 as software timer
PCA0CPL1 = 0xFF;           // Initialize to 255 so that Interrupt
                            // is generated when PCA ends
                            // 8-bit PWM Cycle
PCA0CPH1 = 0x00;           // PCA0CPH is the high byte of the
                            // Output Compare Module

EIE1      = 0x08;           // Enable PCA Overflow Interrupt
}

//-----
// Reset_Time_Base - Resets all Time Counting Values
//-----
void Reset_Time_Base()
{
    TIME.sec      = 0x00;
    TIME.min      = 0x00;
    TIME.hour     = 0x00;
    TIME.t_count  = PWM_CLOCK;
}

//-----
// Delay - This is a Delay to permit time for Switches to Debounce
//-----
void Delay_Loop (void)
{
    long i=0;
    for (i=0;i<100000;i++);
}

//-----
// Initialize CalibrateADCforVoltageMeasurement
//-----
// This function calibrates the voltage channel and stores the calibration
// coefficients in the parameters volt_slope and volt_offset.
//
void CalibrateADCforMeasurement()
// This calibration routine uses a 2 point cal.
{ unsigned char xdata *pwrite;           // FLASH write pointer

    EA = 0;                               // Disable All Interrupts

    // Wait until 1st calibration voltage is ready for cal
    while (SW0 == 1);                       // Wait until SW0 pushed
    Delay_Loop();                             // Wait for Switch Bounce

    // Once ready, Get the first calibration voltage
    AMX0SL = VBAT;                           // Select appropriate input for AMUX
    ADC0CF = (SYSCLK/5000000) << 3;         // ADC conversion clock = 5.0MHz
    ADC0CF &= 0xF8;                           // Clear any Previous Gain Settings
    ADC0CF |= 0x01;                             // PGA gain = 1
    temp_INT_1.i = Measure();

    // Wait until 2nd calibration voltage is ready for cal
    while (SW0 == 1);                       // Wait until SW0 pushed
    Delay_Loop();                             // Wait for Switch Bounce
```



```

// Once ready, Get the 2nd calibration voltage
AMX0SL = VBAT; // Change Mux for second point
temp_INT_2.i = Measure();

// Calculate the SLOPE // V1 and V2 are in tenth of a degree
temp_LONG_1.1 = (unsigned)(temp_INT_2.i-temp_INT_1.i);
temp_LONG_1.1 *= (unsigned)100; // Account for Math Truncation Error
temp_LONG_1.1 /= (unsigned)(V2_CAL - V1_CAL);

// Calculate the OFFSET
temp_LONG_2.1 = (unsigned)temp_INT_1.i;
temp_LONG_2.1 -= (signed)(temp_LONG_1.1 * V1_CAL/100);

temp_LONG_1.1 = 2050; // If no cal. use these
temp_LONG_2.1 = 0; // as default values

// Erased memory at page 0x1A00
pwrite = (char xdata *)&(CHECK_BYTE.b[0]);

PSCTL = 0x03; // MOVX writes target FLASH memory;
// FLASH erase operations enabled

FLKEY = 0xA5; // FLASH key sequence #1
FLKEY = 0xF1; // FLASH key sequence #2
*pwrite = 0x00; // initiate PAGE erase

// Write the Volt SLOPE and OFFSET to Flash
PSCTL = 1; // MOVX writes to Flash

pwrite = (char xdata *)&(VOLT_SLOPE.b[0]);
FLKEY = 0xA5;
FLKEY = 0xF1; // enable flash write
*pwrite = temp_LONG_1.b[0];
pwrite = (char xdata *)&(VOLT_SLOPE.b[1]);
FLKEY = 0xA5;
FLKEY = 0xF1; // enable flash write
*pwrite = temp_LONG_1.b[1];
pwrite = (char xdata *)&(VOLT_SLOPE.b[2]);
FLKEY = 0xA5;
FLKEY = 0xF1; // enable flash write
*pwrite = temp_LONG_1.b[2];
pwrite = (char xdata *)&(VOLT_SLOPE.b[3]);
FLKEY = 0xA5;
FLKEY = 0xF1; // enable flash write
*pwrite = temp_LONG_1.b[3];

pwrite = (char xdata *)&(VOLT_OFFSET.b[0]);
FLKEY = 0xA5;
FLKEY = 0xF1; // enable flash write
*pwrite = temp_LONG_2.b[0];
pwrite = (char xdata *)&(VOLT_OFFSET.b[1]);
FLKEY = 0xA5;
FLKEY = 0xF1; // enable flash write
*pwrite = temp_LONG_2.b[1];
pwrite = (char xdata *)&(VOLT_OFFSET.b[2]);
FLKEY = 0xA5;
FLKEY = 0xF1; // enable flash write
*pwrite = temp_LONG_2.b[2];

```



```
pwrite = (char xdata *)&(VOLT_OFFSET.b[3]);
FLKEY = 0xA5;
FLKEY = 0xF1; // enable flash write
*pwrite = temp_LONG_2.b[3];

PSCTL = 0; // MOVX writes target XRAM

//-----
// Initialize CalibrateADCforCurrentMeasurement_NOAMP
//-----
// This function calibrates the current channel with no external amp
// and stores the calibration coefficients in the
// parameters i_noamp_slope and i_noamp_offset.
//
// This calibration routine uses a 2 point cal.
// Wait until calibration voltage is ready for cal
while (SW0 == 1); // Wait until SW0 pushed
Delay_Loop(); // Wait for Switch Bounce
// Once ready, Get the first calibration voltage
AMXOSL = IBAT; // Select appropriate input for AMUX
ADCOCF = (SYSCLK/5000000) << 3; // ADC conversion clock = 5.0MHz
ADCOCF &= 0xF8; // Clear any Previous Gain Settings
ADCOCF |= 0x03; // Set PGA gain = 4
temp_INT_1.i = Measure(); // Acquire 16-bit Conversion
temp_INT_1.i *= 2; // Account for Differential Mode
// Wait until 2nd calibration voltage is ready for cal
while (SW0 == 1); // Wait until SW0 pushed
Delay_Loop(); // Wait for Switch Bounce

// Once ready, Get the 2nd calibration voltage
temp_INT_2.i = Measure(); // Acquire 16-bit Conversion
temp_INT_2.i *= 2; // Account for Differential Mode

// Calculate the SLOPE
temp_LONG_1.l = (unsigned)(temp_INT_2.i - temp_INT_1.i);
temp_LONG_1.l *= (unsigned)100; // Account for Math Truncation Error
temp_LONG_1.l /= (unsigned)(I2_CAL - I1_CAL);
temp_LONG_1.l /= (unsigned)CURRENT_GAIN; // Account for Gain

// Calculate the OFFSET
temp_LONG_2.l = (signed)(temp_INT_1.i/CURRENT_GAIN);
temp_LONG_2.l -= (signed)(temp_LONG_1.l * V1_CAL/100);

temp_LONG_1.l = 2050; // If no cal. use these
temp_LONG_2.l = 0; // as default values

// Memory at 0x1A00 is already erased
// Write the Volt SLOPE and OFFSET to Flash
PSCTL = 1; // MOVX writes to Flash

pwrite = (char xdata *)&(I_NOAMP_SLOPE.b[0]);
FLKEY = 0xA5;
FLKEY = 0xF1; // enable flash write
*pwrite = temp_LONG_1.b[0];
pwrite = (char xdata *)&(I_NOAMP_SLOPE.b[1]);
FLKEY = 0xA5;
FLKEY = 0xF1; // enable flash write
*pwrite = temp_LONG_1.b[1];
pwrite = (char xdata *)&(I_NOAMP_SLOPE.b[2]);
```

```

FLKEY = 0xA5;
FLKEY = 0xF1;                // enable flash write
*pwrite = temp_LONG_1.b[2];
pwrite = (char xdata *)&(I_NOAMP_SLOPE.b[3]);
FLKEY = 0xA5;
FLKEY = 0xF1;                // enable flash write
*pwrite = temp_LONG_1.b[3];
pwrite = (char xdata *)&(I_NOAMP_OFFSET.b[0]);
FLKEY = 0xA5;
FLKEY = 0xF1;                // enable flash write
*pwrite = temp_LONG_2.b[0];
pwrite = (char xdata *)&(I_NOAMP_OFFSET.b[1]);
FLKEY = 0xA5;
FLKEY = 0xF1;                // enable flash write
*pwrite = temp_LONG_2.b[1];
pwrite = (char xdata *)&(I_NOAMP_OFFSET.b[2]);
FLKEY = 0xA5;
FLKEY = 0xF1;                // enable flash write
*pwrite = temp_LONG_2.b[2];
pwrite = (char xdata *)&(I_NOAMP_OFFSET.b[3]);
FLKEY = 0xA5;
FLKEY = 0xF1;                // enable flash write
*pwrite = temp_LONG_2.b[3];

PSTCTL = 0;                  // MOVX writes target XRAM
}

//-----
// Measure
//-----
//
// This routine averages 65536 ADC samples and returns a 16-bit unsigned
// result.
//
unsigned int Measure (void)
{
    unsigned i;                // sample counter
    unsigned long accumulator=0L; // here's where we integrate the
                                // ADC samples

    // read the ADC value and add to running total
    i = 0;
    do {
        ADOINT = 0;            // clear end-of-conversion indicator
        ADOBUSY = 1;           // initiate conversion
        while(!ADOINT);        // wait for conversion to complete
        accumulator += ADC0;    // read adc value and accumulate
        i++;                    // update counter
    } while (i != 0x0000);

    // the accumulator now contains 16 added bits of which 8 are usable
    return (unsigned int) (accumulator >> 8);
}

//-----
// Regulate_Current
//-----
// This routine monitors the battery's current and adjusts
// the PWM (i.e. duty cycle) to keep the current at a known value

```



# AN137

---

```
//
void Regulate_Current(int passed_current)
{ unsigned int temp = 0;

do{
    temp = Monitor_Battery(CURRENT);    // Measure Current

    if (temp < passed_current)
        PCA0CPH0--;
    if (temp > passed_current)
        PCA0CPH0++;

}while ((temp < (passed_current - CURRENT_TOLERANCE)) ||
        (temp > (passed_current + CURRENT_TOLERANCE)));
        // I_BULK or I_LOWCURRENT is set now

temp = Monitor_Battery(VOLTAGE_PWM_OFF);
        // If VOLTAGE within range,
        // change from constant CURRENT charge
        // mode to constant VOLTAGE charge mode
if ((temp >= (VOLT_LOWCURRENT - VOLT_TOLERANCE)) &&
    (temp <= (VOLT_LOWCURRENT + VOLT_TOLERANCE)))
{
    CONST_C = 0;
    CONST_V = 1;
}

}

//-----
// Regulate_Voltage
//-----
// This routine monitors the battery's voltage and adjusts
// the PWM (i.e. duty cycle) to keep the voltage at a known value
//
void Regulate_Voltage(void)
{ unsigned int temp = 0;

        // set VOLT_BULK (with "soft start")

do{
    temp = Monitor_Battery(VOLTAGE);

    if (temp < VOLT_BULK)
        PCA0CPH0--;
    if (temp > VOLT_BULK)
        PCA0CPH0++;

}while ((temp < (VOLT_BULK - VOLT_TOLERANCE)) ||
        (temp > (VOLT_BULK + VOLT_TOLERANCE)));
        // VOLTAGE is set now

}

//-----
// Turn_PWM_Off
//-----
// This routine performs a soft charge turn off by taking the PWM's
// duty cycle slowly to zero.
//
void Turn_PWM_Off(void)
{
```

```

do{
    if (PCA0CPH0 < 0xF0)
        PCA0CPH0++;

}while (PCA0CPH0 < 0xF0);
// Duty Cycle is now small and safe to turn off.

PCA0CPM0 = 0x00;                // Disable PWM
}

//-----
// Monitor_Battery
//-----
// This routine acts as a switch when gathering different conversion types.
// It adjusts the throughput, adjust the AMUX and returns the current in mA,
// voltage in mV, and temperature in C, 2% accurate.
//
int Monitor_Battery(unsigned char value)
{
    char i;
    unsigned long av =0;
    long signed result;

    ADC0CF = (SYSCLK/5000000) << 3;    // ADC conversion clock = 5.0MHz
    ADC0CF &= 0xF8;                    // Clear any Previous Gain Settings

    switch (value)
    {
        case TEMPERATURE:
            Turn_PWM_Off();            // Turn PWM Off
            AMX0SL = TBAT;              // Select appropriate input for AMUX
            ADC0CF |= 0x02;            // Set PGA gain = 2
            break;

        case VOLTAGE:
            AMX0SL = VBAT;              // Select appropriate input for AMUX
            ADC0CF |= 0x01;            // Set PGA gain = 1
            break;

        case VOLTAGE_PWM_OFF:
            Turn_PWM_Off();            // Turn PWM Off
            AMX0SL = VBAT;              // Select appropriate input for AMUX
            ADC0CF |= 0x01;            // Set PGA gain = 1
            break;

        case CURRENT:
            AMX0SL = IBAT;              // Select appropriate input for AMUX
            ADC0CF |= 0x03;            // Set PGA gain = 4
            break;

    }

    //Compute average of next 10 A/D conversions
    for(av=0,i=10;i--i){
        AD0INT = 0;                    // clear end-of-conversion indicator
        AD0BUSY = 1;                  // initiate conversion
        while(!AD0INT);               // wait for conversion to complete
        av = av+ADC0;
    }
}

```

# AN137

---

```
av = av/10; // Compute the average
av = av<<8; // Convert to 16-bit conversion
// ...to account for 16-bit cal.
// coefficients

PCAOCPM0 = 0x42; // Turn on PWM

switch (value)
{ case TEMPERATURE:
    result = (long) av * 1000/TEMP_SLOPE;
    break;

    case VOLTAGE:
    case VOLTAGE_PWM_OFF:
    result = (av - VOLT_OFFSET.1); // Account for System Errors
    result /= VOLT_SLOPE.1; // Convert to Voltage in Millivolts
    result *= 100; // Account for Math Truncation Error
    result *= RESAB; // Account for Divide Resistors
    result /= RESB;
    break;
    case CURRENT:
    result = av*2; // Account for Differential Mode
    result -= I_NOAMP_OFFSET.1; // Account for System Errors
    result /= I_NOAMP_SLOPE.1; // Convert to Milliamps
    result *= 100; // Account for Math Truncation Error
    result /= RSENSE; // Account for Sense Resistor
    result *= RESAB; // Account for Divide Resistors
    result /= RESB;
    result /= CURRENT_GAIN;
    break;
}

return (int) result;
}

//-----
// Bulk_Charge Function
//-----
void Bulk_Charge(void)
{
    unsigned int temp = 0;
    unsigned int bulk_finish_hour = 0;
    unsigned int bulk_finish_min = 0;
    unsigned int delay_hour = 0;
    unsigned int delay_min = 0;
    unsigned int last_min = 0;

    Reset_Time_Base(); // Reset Time Base to zero

    // Calculate BULK charge finish time
    bulk_finish_min = (TIME.min + MAX_TIME_BULK);
    bulk_finish_hour = TIME.hour;
    while (bulk_finish_min > 60)
    {
        bulk_finish_min = bulk_finish_min - 60;
        bulk_finish_hour++;
    }
}
```

```

CONST_C = 1;           // Start in constant current charge mode
DELAY    = 0;         // Reset timer DELAY

temp = Monitor_Battery(TEMPERATURE); // Monitor Temperature
// Is temperature within range?

if ((temp > MIN_TEMP_ABS) && (temp < MAX_TEMP_ABS))
{
    temp = Monitor_Battery(VOLTAGE); // Monitor Voltage
// Is Voltage within range?
    if ((temp <= (MAX_VOLT_ABS + VOLT_TOLERANCE)) && temp > MIN_VOLT_BULK)
    {
        PCA0CPM0 = 0x42; // Configure CCM0 to 8-bit PWM mode

// Enter main loop in Bulk_Charge()
        while ((BULK == 1) && (ERROR == 0))
        {
            if (CONST_C == 1)
                Regulate_Current(I_BULK); // Charge with Constant Current

            else if (CONST_V == 1)
                Regulate_Voltage(); // Charge with Constant Voltage

// Now, Check for error and charge termination conditions
// If above max charge time, flag error
// Test for BULK Charge Time Out

// Monitor Time
            if ((TIME.hour == bulk_finish_hour) && (TIME.min == bulk_finish_min)
                && (DELAY == 0))
            {
                Turn_PWM_Off(); // Turn Off PWM
                TIME_MAX = 1; // Set Time max error flag
                ERROR = 1; // Set general error flag
            }

// Monitor Temperature
            temp = Monitor_Battery(TEMPERATURE);
            if ((temp < MIN_TEMP_ABS) && (temp > MAX_TEMP_ABS))
            {
                Turn_PWM_Off(); // Turn Off PWM

                if (temp < MIN_TEMP_ABS)
                    TEMP_MIN = 1; // Set Temperature below minimum flag
                else
                    TEMP_MAX = 1; // Set Temperature exceeds maximum flag

                ERROR = 1; // Set general error flag
            }

// Minute elapsed?
// Check for minimum current
// if reached, enter last DELAY charge
            if (TIME.min != last_min)
            {
                last_min = TIME.min;
                if ((CONST_V == 1) && (DELAY == 0) && (Monitor_Battery(CURRENT)
                    <= MIN_I_BULK))

```



```

    {
        // Calculate TOP OFF Battery Time finish time
        delay_min = (TIME.min + BULK_TIME_DELAY);
        delay_hour = TIME.hour;
        while (delay_min > 60)
        {
            delay_min = delay_min - 60;
            delay_hour++;
        }
        DELAY = 1; // Set Delay Flag
    }

    // Monitor Delay time, time up?
    if ((TIME.hour == delay_hour)&&(TIME.min == delay_min) &&
        (DELAY == 1))
    {
        Turn_PWM_Off(); // Turn Off PWM
        CONST_V = 0; // Exit CONST_V
        CONST_C = 1; // Prepare to enter CONST_C
        BULK = 0; // Prepare to exit BULK mode
        LOWCURRENT = 1; // Prepare to enter LOWCURRENT Mode
    }
} // End Main While loop

else if(ERROR == 0)
{
    if (temp > (MAX_VOLT_ABS + VOLT_TOLERANCE))
    { VOLT_MAX = 1; // Set Max Voltage error flag
      ERROR = 1; // Set general error flag
    }
    else if(temp < MIN_VOLT_BULK)
    { VOLT_MIN = 1; // Set Minimum bulk voltage error flag
      LOWCURRENT = 1; // Switch to LOWCURRENT mode
      BULK = 0; // Exit Bulk Charge mode
    } // battery's voltage very low
}

else if(ERROR == 0) // Absolute temperature out of range?
{
    if (temp < MIN_TEMP_ABS)
        TEMP_MIN = 1; // Set Temperature below minimum flag
    else
        TEMP_MAX = 1; // Set Temperature exceeds maximum flag

    ERROR = 1; // Set general error flag
}

//-----
// Lowcurrent_Charge
//-----

void Lowcurrent_Charge(void)
{
    unsigned int temp = 0;
    unsigned int lowcurrent_finish_min = 0;

```



```

unsigned int lowcurrent_finish_hour = 0;

Reset_Time_Base(); // Reset Time base to zero

// Calculate LOWCURRENT finish time
lowcurrent_finish_min = (TIME.min + MAX_TIME_LOWCURRENT);
lowcurrent_finish_hour = TIME.hour;
while (lowcurrent_finish_min > 60)
{
    lowcurrent_finish_min = lowcurrent_finish_min - 60;
    lowcurrent_finish_hour++;
}

// Enter Main Lowcurrent Loop.
// Only exits are upon error and full charge
while ((LOWCURRENT == 1) && (ERROR == 0))
{
    temp = Monitor_Battery(TEMPERATURE); // Get Temperature Reading
    // Is TEMPERATURE within limits
    if ((temp > MIN_TEMP_ABS) && (temp < MAX_TEMP_ABS))
    {
        // Is Battery's Charge Voltage below max charge voltage
        temp = Monitor_Battery(VOLTAGE); // Get Voltage Reading
        if (temp <= (VOLT_LOWCURRENT + VOLT_TOLERANCE))
        {
            if (CONST_C == 1) // CONST_C ?, charge w/ constant current
                Regulate_Current(I_LOWCURRENT);

            if (CONST_V == 1) // CONST_V?, charge w/ constant voltage
                Regulate_Voltage();

            if ((temp >= MIN_VOLT_BULK) && (DELAY == 0)) // Bulk Threshold voltage met?
            {
                LOWCURRENT = 0; // Exit LOWCURRENT mode
                BULK = 1; // Switch to Bulk Charge mode
            }

            // Check elapsed time
            if ((TIME.hour == lowcurrent_finish_hour) &&
                (TIME.min == lowcurrent_finish_min))
            {
                TIME_MAX = 1; // Set Time MAX error flag
                ERROR = 1; // Set general error flag
            }
        }
        else if (ERROR == 0) // Voltage to high?
        {
            VOLT_MAX = 1; // Set Max voltage error flag
            ERROR = 1; // Set general error flag
        }
    }
    else if (ERROR == 0) // Absolute temperature out of range?
    {
        if (temp < MIN_TEMP_ABS)
            TEMP_MIN = 1; // Set Temperature below minimum flag
        else
            TEMP_MAX = 1; // Set Temperature exceeds maximum flag

        ERROR = 1; // Set general error flag
    }
}

```



# AN137

---

```
}

//-----
// Main Function
//-----
void main(void)
{
    EA = 0;                // Disable All Interrupts
    Reset_Time_Base();
    Config_F300();        // Config F300
    CalibrateADCforMeasurement(); // Calibrate F300

    EA = 1;                // Enable All Active Interrupts

    while(1)
    {
        LED0 = 0;         // Turn LED0 off

        TERMINATION = 0x00; // Reset Termination Flags
        CHARGE_STATUS = 0x00; // Reset Charge Status Flags
        BULK = 1;          // Start in LOWCURRENT Charge mode
        CONST_C = 1;

        while (SW0 == 1); // Wait until SW0 pushed
        Delay_Loop();     // Wait for Switch Bounce

        while (ERROR == 0)
        {
            if (BULK == 1)
            {
                LED0 = 1; // Turn LED0, indicates Bulk Mode
                Bulk_Charge(); // Enter Bulk Charge Mode
            }
            if (LOWCURRENT == 1)
                Lowcurrent_Charge(); // Enter Lowcurrent_Charge function
                // Toggle LED0 at 1 Hz rate via ISR
        }

        if (ERROR == 1)
        {
            Turn_PWM_Off(); // Turn PWM Off
            LED0 = 0;       // Turn OFF LED0 to indicate "ERROR".
            EA = 0;        // Disable All Interrupts
            while (1);     // Enter a eternal loop
            // No recovery except "reset-button"
        }
    }
}

//-----
// PCA_ISR
//-----
// This routine counts the elapsed time in seconds, minutes, hours.
// It also toggles LED0 every second when in Lowcurrent Charge Mode.
// This routine interrupts every time the PCA counter overflows, every 256
// SYSCLK cycles. After SYSCLK/256 interrupts, one second has elapsed.
//
void PCA_OVERFLOW_ISR (void) interrupt 9
{
```

```
PCAOCN = 0x40; // Reset all PCA Interrupt Flags

PCA0H = 0x00; // Reset High Byte of PCA Counter
// of 8-bit PWM we are using Module1

if (0x0000 == --TIME.t_count)
{
    TIME.t_count = PWM_CLOCK; // Reset 1 Second Clock
    if ( 60 == ++TIME.sec ) // Account for elapsed seconds
    { // Reset second counter every minute
        TIME.sec = 0x00;
        if ( 60 == ++TIME.min ) // Account for elapsed minutes
        { // Reset minute counter every hour
            TIME.min = 0x00;
            if ( 24 == ++TIME.hour ) // Account for elapsed hours
            { // Reset hour counter every day
                TIME.hour = 0x00;
            }
        }
    }
}

if ((LOWCURRENT == 1) && (ERROR == 0))
{ // Blink LED0 at 1 Hz if in Lowcurrent
    if (TIME.sec % 2) // Turn on LED every odd second
        LED0 = 0;
    else // Turn on LED every even second
        LED0 = 1;
}
}

// END OF FILE
```

## Contact Information

Silicon Laboratories Inc.  
4635 Boston Lane  
Austin, TX 78735  
Tel: 1+(512) 416-8500  
Fax: 1+(512) 416-9669  
Toll Free: 1+(877) 444-3032  
Email: [productinfo@silabs.com](mailto:productinfo@silabs.com)  
Internet: [www.silabs.com](http://www.silabs.com)

The information in this document is believed to be accurate in all respects at the time of publication but is subject to change without notice. Silicon Laboratories assumes no responsibility for errors and omissions, and disclaims responsibility for any consequences resulting from the use of information included herein. Additionally, Silicon Laboratories assumes no responsibility for the functioning of undescribed features or parameters. Silicon Laboratories reserves the right to make changes without further notice. Silicon Laboratories makes no warranty, representation or guarantee regarding the suitability of its products for any particular purpose, nor does Silicon Laboratories assume any liability arising out of the application or use of any product or circuit, and specifically disclaims any and all liability, including without limitation consequential or incidental damages. Silicon Laboratories products are not designed, intended, or authorized for use in applications intended to support or sustain life, or for any other application in which the failure of the Silicon Laboratories product could create a situation where personal injury or death may occur. Should Buyer purchase or use Silicon Laboratories products for any such unintended or unauthorized application, Buyer shall indemnify and hold Silicon Laboratories harmless against all claims and damages.

Silicon Laboratories and Silicon Labs are trademarks of Silicon Laboratories Inc.

Other products or brandnames mentioned herein are trademarks or registered trademarks of their respective holders.