

Product Features

- Integrated Monolithic GaAs Mixer Package Module
- High Reliability
- Lower Manufacturing Cost
- Higher Productivity
- Very Low Noise Figure & Low Distortion

Application

- Repeater
- Base Station
- RF Sub-Systems



Package Type: HY-2

Description

The IC operates from a positive +5V rail consuming 145 mA of current while only requiring a 2 ± 2 dBm LO drive. The MCM is implemented with reliable and mature GaAs MESFET technology.

Specifications

(Operating Temperature: $-30^{\circ}\text{C} \sim +70^{\circ}\text{C}$)

Part Number	RF Frequency (MHz)	IF Frequency (MHz)	Conversion Gain (dB)	OIP3 (dBm)	IIP3 (dBm)	NF (dB)	Output P1dB (dB)	LO to IF Leakage (dBm)	RF to IF Leakage (dBm)
MD1891	1700~1820	50~200	10	26	16	8.5	10	-16	-20
	1820~1920		9	26	17				

Test Conditions : $T_a=25^{\circ}\text{C}$, $V_{dd}=5\text{V}$, $P_{LO}2\text{dBm}$, $IF=70\text{MHz}$

Functional Diagram

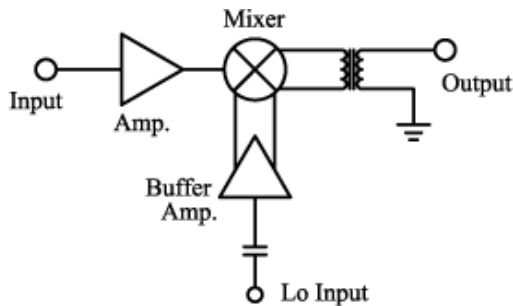

Functional Pin Layout

Pin No.	Function
1 or 14	Vdd+5V
5	RF In
9	LO In
12	IF Out
2,3,4,6,7,8,10,11,13	Ground

Package Dimensions (Type: HY-2)

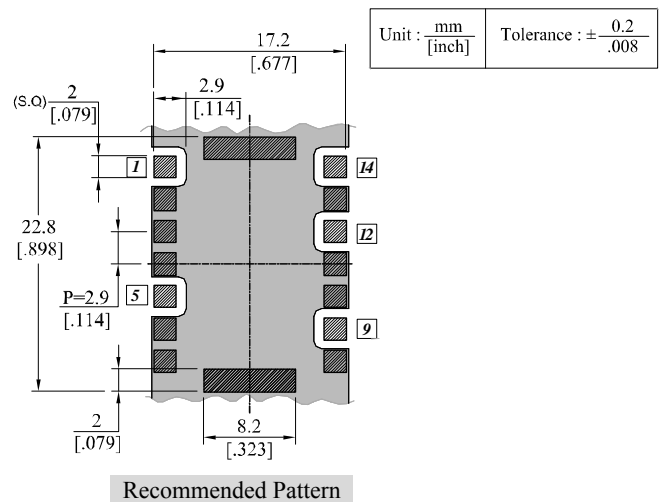
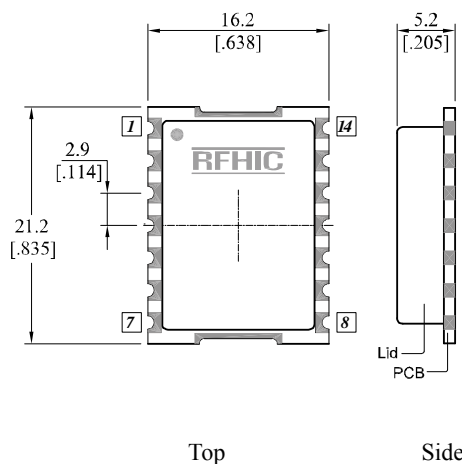

Test Condition: RF = 1700~1920MHz, LO = 1630~1850MHz@2dBm, IF = 70MHz

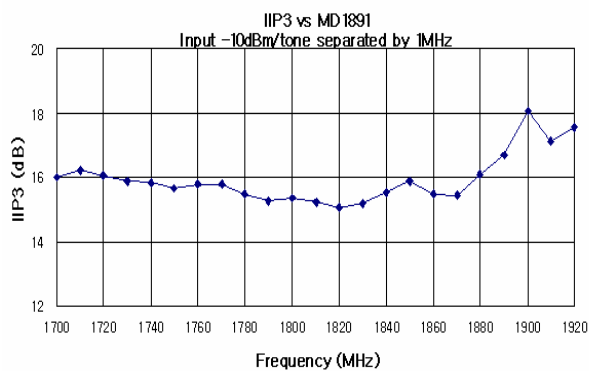
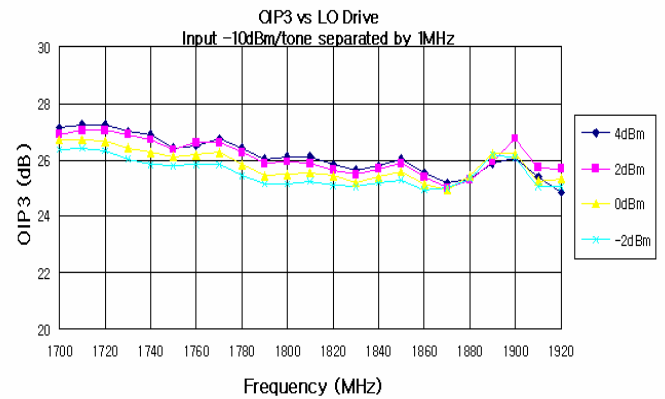
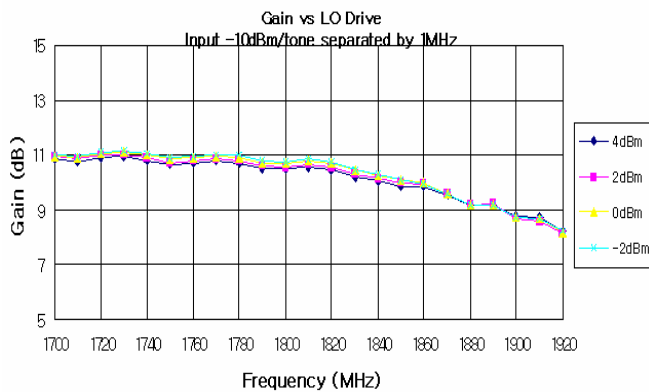
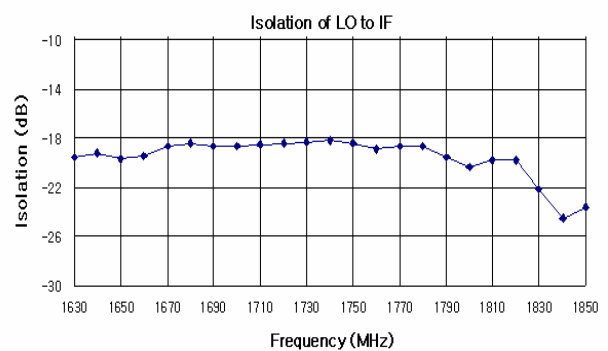
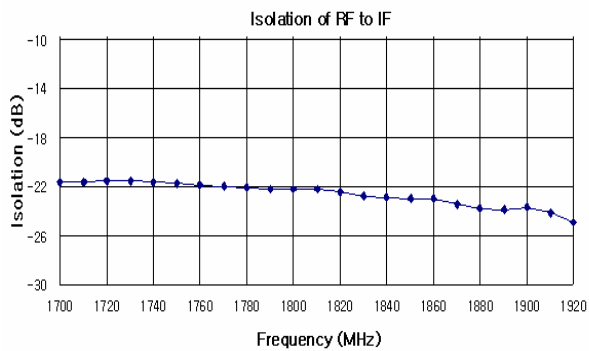
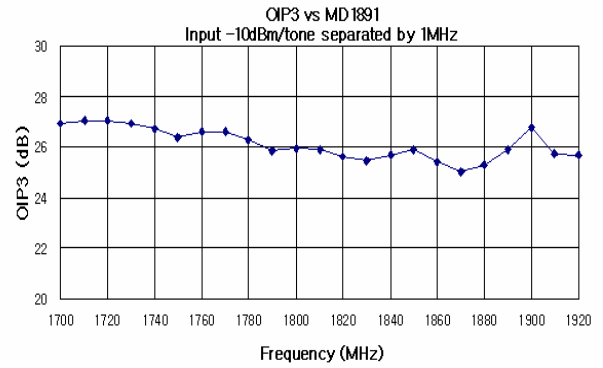
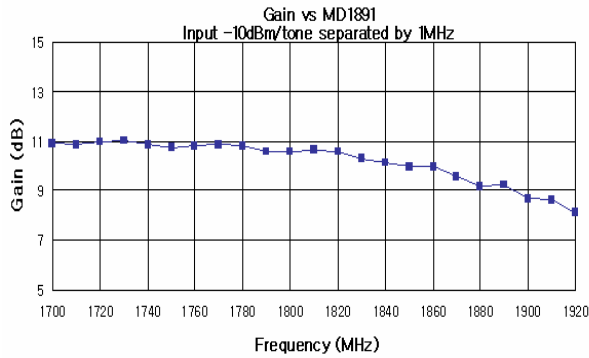

Test Condition: RF = 1700~1920MHz, LO = 1560~1780MHz@2dBm, IF = 140MHz

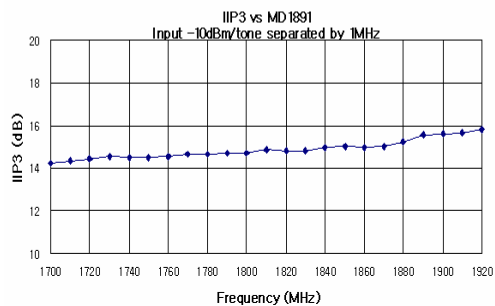
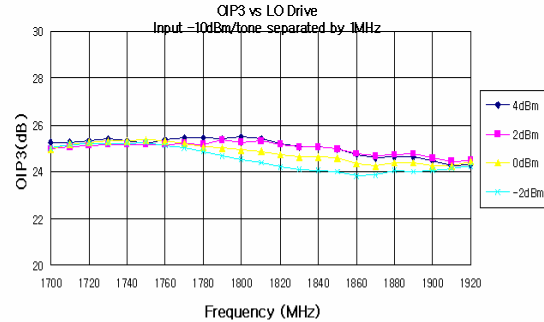
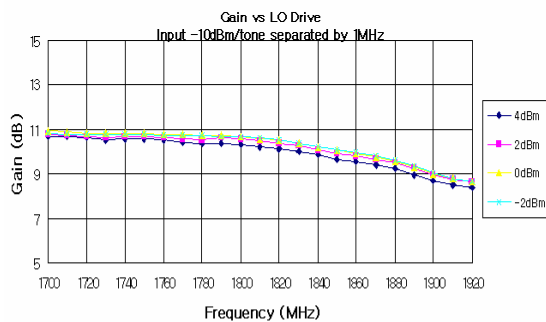
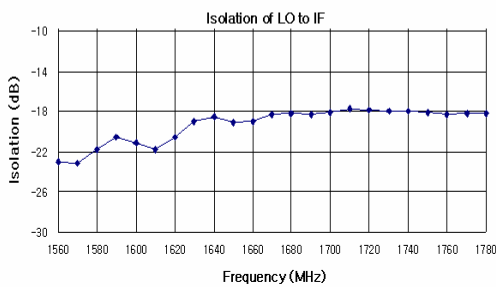
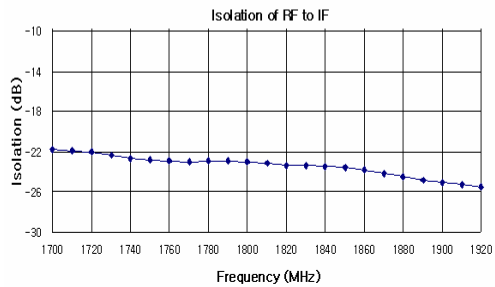
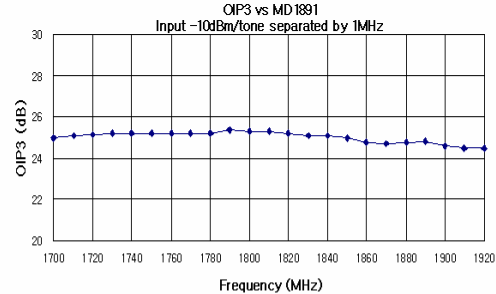
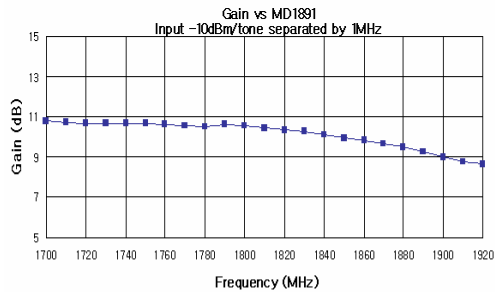

RFHIC Corporation (RFHIC) reserves the right to make changes to any products herein or to discontinue any product at any time without notice. RFHIC do not assume any liability for the suitability of its products for any particular purpose, and disclaims any and all liability, including without limitation consequential or incidental damages. The product specifications herein expressed have been carefully checked and are assumed to be reliable. However, RFHIC disclaims liability for inaccuracies and strongly recommends buyers to verify that the information they are using is current before placing purchase orders. RFHIC products are not intended for use in life support equipment or application where malfunction of the product can be expected to result in personal injury or death. Buyer uses or sells such products for any such unintended or unauthorized application, buyer shall indemnify, protect and hold RFHIC and its directors, officers, stockholders, employees, representatives and distributors harmless against any and all claims arising out of such use. RFHIC's liability under or arising out of damages, claims of whatsoever kind and nature which RFHIC products could cause shall be limited in amount to the net purchase price of the products sold to buyer by RFHIC.