

GJ2138

1.5A CMOS Low Dropout Voltage Regulator

Description

The GJ2138 series of positive, linear regulators feature low quiescent current (45µA typ.) with low dropout voltage, making them ideal for battery applications.

These rugged devices have both Thermal Shutdown, and Current Fold-back to prevent device failure under the "Worst" of operating conditions.

The GJ2138 is stable with an output capacitance of 4.7µF or greater.

Features

- Very Low Dropout Voltage
- Guaranteed 1.5A output
- Over-Temperature Shutdown
- Current Limiting
- Short Circuit Current Fold-back
- Highly Accurate ± 1.5%
- Low Temperature Coefficient

Applications

- Battery Powered Widgets
- Instrumentation
- Wireless Devices
- PC Peripherals
- Portable Electronics

Functional Block Diagram

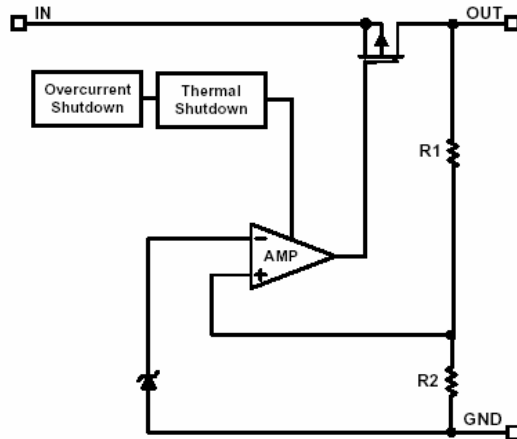

Package Dimensions

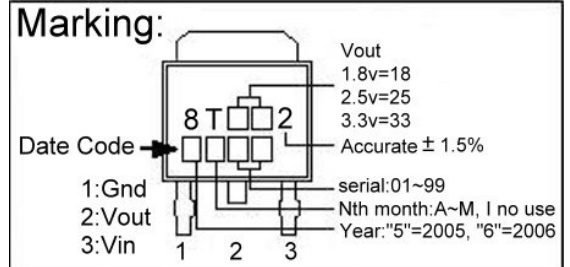
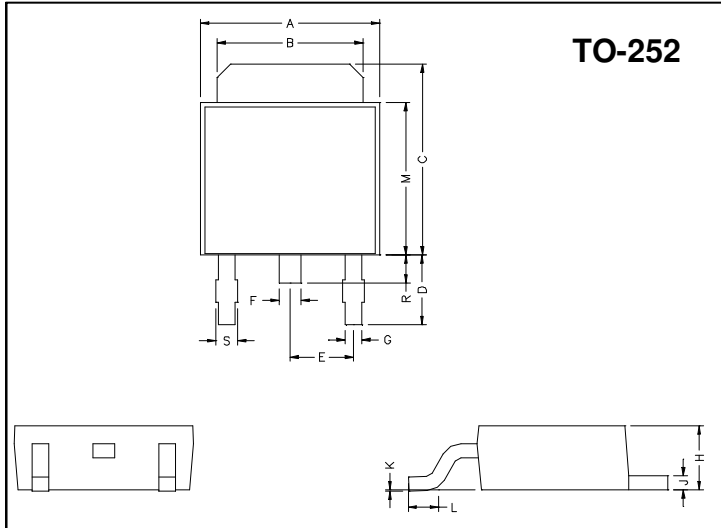

REF.	Millimeter		REF.	Millimeter	
	Min.	Max.		Min.	Max.
A	6.40	6.80	G	0.50	0.70
B	5.20	5.50	H	2.20	2.40
C	6.80	7.20	J	0.45	0.55
D	2.40	3.00	K	0	0.15
E	2.30 REF.		L	0.90	1.50
F	0.70	0.90	M	5.40	5.80
S	0.60	0.90	R	0.80	1.20

Typical Application Circuit

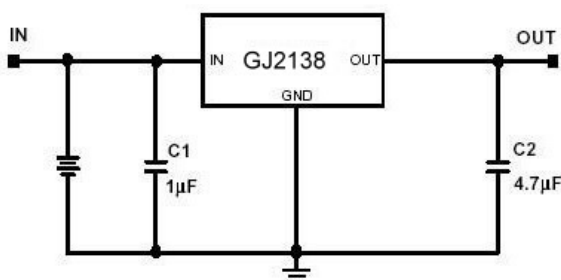

Absolute Maximum Ratings

Parameter	Symbol	Ratings	Unit
Input Max Voltage	V _{IN}	8	V
Output Current	I _{OUT}	PD/(V _{IN} -V _O)	A
Output Voltage	V _{OUT}	1.5~5.0	V
Operating Ambient Temperature	T _{opr}	-40 ~ +85	°C
Junction Temperature	T _j	-40 ~ +125	°C
Maximum Junction Temperature	T _{j Max}	150	°C
Thermal Resistance	θ _{jc} (Non-Conductive Epoxy)*	30	°C/W
	θ _{ja}	140	°C/W
Internal Power Dissipation	PD	1	W
EDS Classification		B	

*Measure θ_{jc} on backside center of tab.**Electrical Characteristics** V_{IN}=V_{OUT}(T)+2V, T_a=25°C unless otherwise noted

Parameter	Symbol	Condition	Min	TYP	Max	Unit	
Output Voltage	V _{OUT} (E) (Note1)	I _O =1mA	-1.5%	V _{OUT} (T) (Note2)	1.5%	V	
Output Current	I _O	V _O >1.2V	1.5	-	-	A	
Current Limit	I _{LIM}	V _O >1.2V	1.5	2.0	-	A	
Load Regulation	REG _{LOAD}	V _{IN} =V _{OUT} (T)+2V, I _O =1mA to 1.5A	-1	0.2	1	%	
Dropout Voltage	V _{DROPOUT}	I _O =1.5A V _O =V _{OUT} (E)-2%	1.4V<V _{OUT} (T)≤2.0V	-	-	1300	mV
			2.0V<V _{OUT} (T)≤2.8V	-	-	800	
			2.8V<V _{OUT} (T)	-	-	600	
Quiescent Current	I _Q	V _{IN} =V _{OUT} (T)+2V, I _O =0mA	-	45	70	μA	
Ground Pin Current	I _{GND}	V _{IN} =V _{OUT} (T)+2V, I _O =1mA~1.5A	-	45	-	μA	
Line Regulation	REG _{LINE}	I _O =1mA V _{IN} =V _{OUT} (T)+1 to V _{OUT} (T)+2	V _{OUT} (T)<2.0V	-0.15	-	0.15	%
			2.0V≤V _{OUT} (T)<4.0V	-0.1	0.02	0.1	
			4.0V≤V _{OUT} (T)	-0.4	-	0.4	
Input Voltage	V _{IN}		Note3	-	7	V	
Over Temperature Shutdown	OTS		-	150	-	°C	
Over Temperature Hysterisis	OTH		-	30	-	°C	
Output Voltage Temperature Coefficient	TC		-	30	-	ppm/°C	
Short Circuit Current	I _{SC}	V _{IN} =V _{OUT} (T)+1V, V _{OUT} <0.4V	-	750	-	mA	
Power Supply Rejection	PSRR	I _O =100mA C _O =4.7μF	f=100Hz	-	70	-	dB
			f=1kHz	-	50	-	
			f=10kHz	-	20	-	
Output Voltage Noise	e _N	f=10Hz~100kHz, I _O =10mA, C _O =4.7μF	-	30	-	μVrms	

Note 1: V_{OUT}(E) =Effective Output Voltage (i.e. the output voltage when "V_{OUT}(T) + 2.0V" is provided at the V_{IN} pin while maintaining a certain I_{OUT} value).2: V_{OUT}(T) =Specified Output Voltage3: V_{IN}(MIN) =V_{OUT}+V_{DROPOUT}**Ordering Information (contd.)**

Part Number	Marking	Output Voltage	Part Number	Marking	Output Voltage
GJ2138-15	8T152 XXXX	1.5V	GJ2138-18	8T182 XXXX	1.8V
GJ2138-19	8T192 XXXX	1.9V	GJ2138-25	8T252 XXXX	2.5V
GJ2138-33	8T332 XXXX	3.3V	GJ2138-47	8T472 XXXX	4.75V
GJ2138-50	8T502 XXXX	5.0V			

Detailed Description

The GJ2138 series of COMS regulators contain a PMOS pass transistor, voltage reference, error amplifier, over-current protection, and thermal shutdown.

The P-channel pass transistor receives data from the error amplifier, over-current shutdown, and thermal protection circuits. During normal operation, the error amplifier compares the output voltage to a precision reference. Over-current and Thermal shutdown circuits become active when the junction temperature exceeds 150°C, or the current exceeds 2.2A. During thermal shutdown, the output voltage remains low. Normal operation is restored when the junction temperature drops below 120°C.

The GJ2138 behaves like a current source when the load reaches 2.2A. However, if the load impedance drops below 0.3Ω, the current drops back to 600mA to prevent excessive power dissipation. Normal operation is restored when the load resistance exceeds 0.75Ω.

External Capacitors

The GJ2138 is stable with an output capacitance to ground of 4.7μF or greater. Ceramic capacitors have the lowest ESR, and will offer the best AC performance. Conversely, Aluminum Electrolytic capacitors exhibit the highest ESR, resulting in the poorest AC response. Unfortunately, large value ceramic capacitors are comparatively expensive. One option is to parallel a 0.1μF ceramic capacitor with a 10μF Aluminum Electrolytic. The benefit is low ESR, high capacitance, and low overall cost.

A second capacitor is recommended between the input and ground to stabilize V_{in} . The input capacitor should be at least 0.1μF to have a beneficial effect.

All capacitors should be placed in close proximity to the pins. A “Quiet” ground termination is desirable. This can be achieved with a “Star” connection.

Characteristics Curve

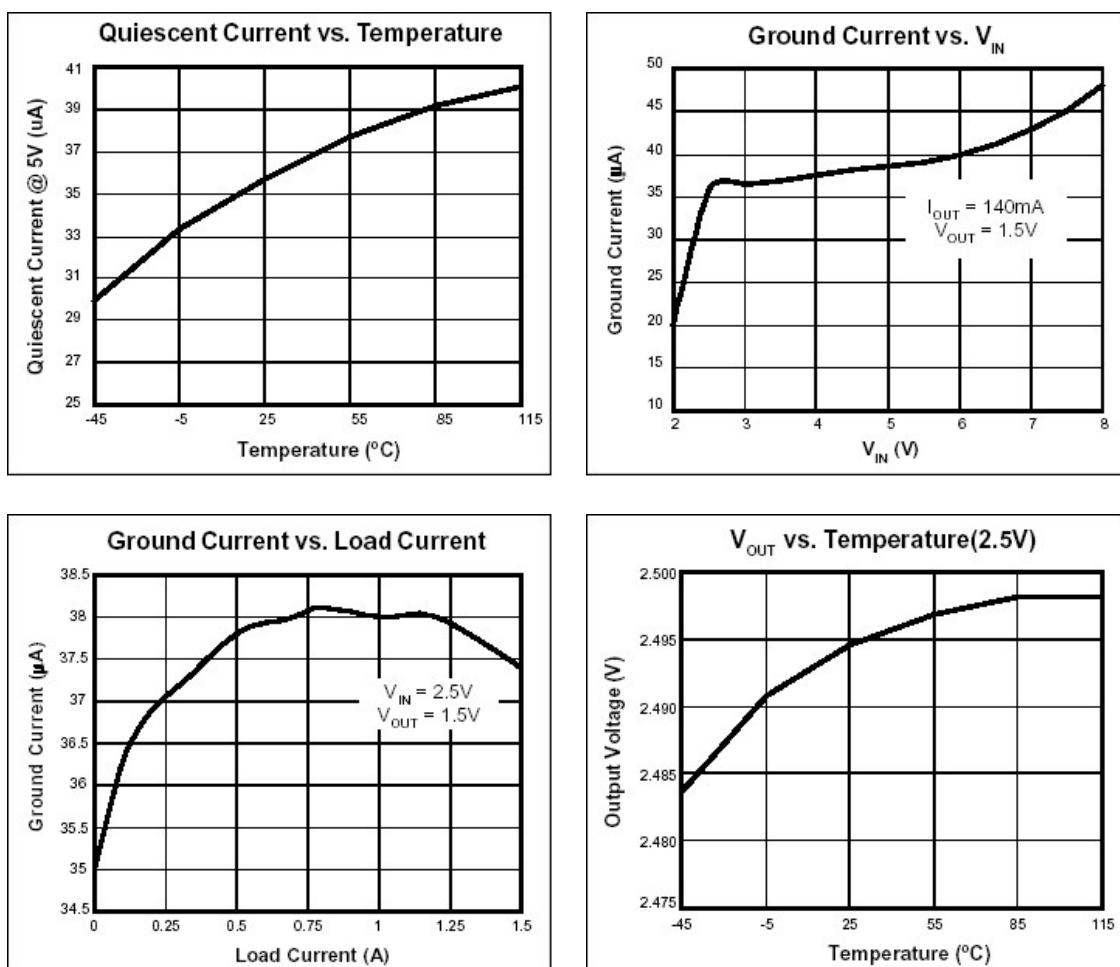

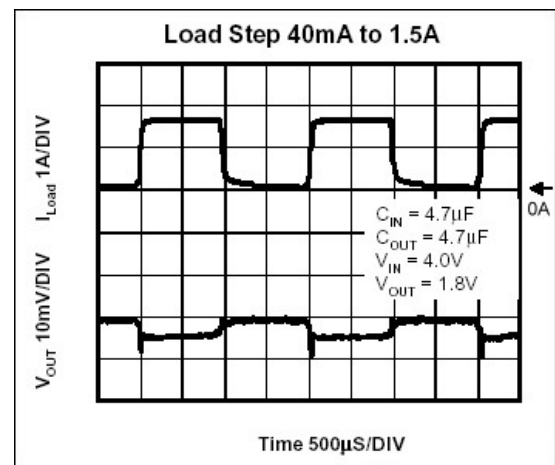
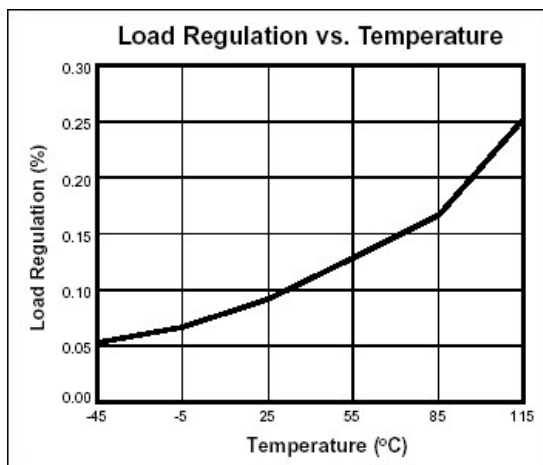
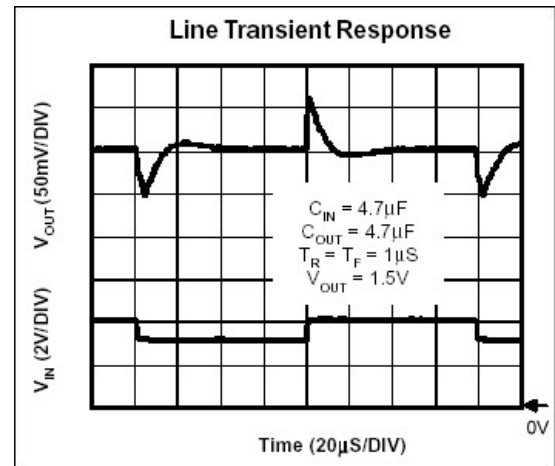
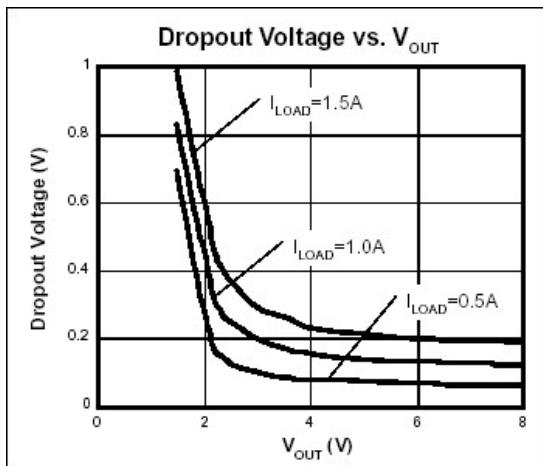
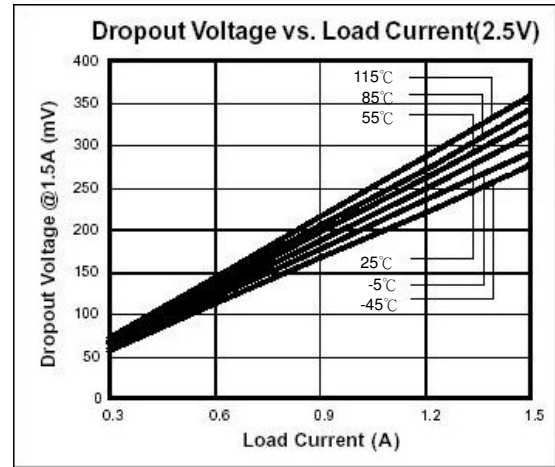
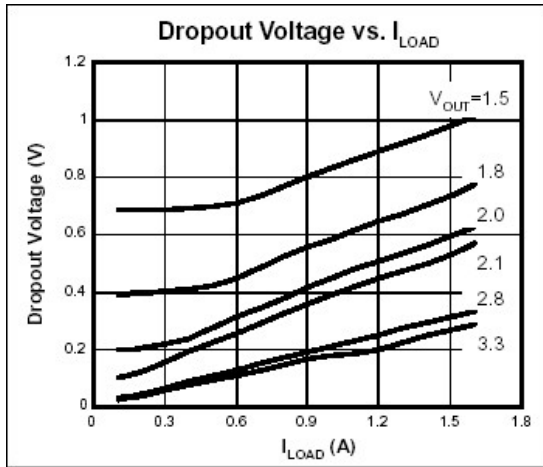

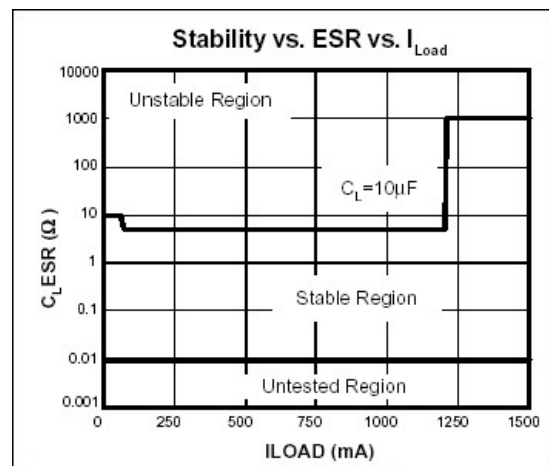
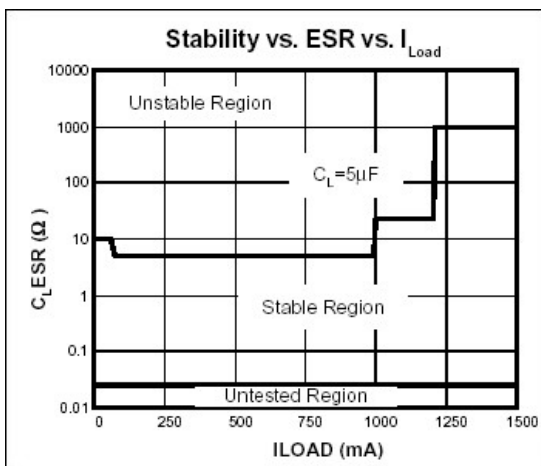
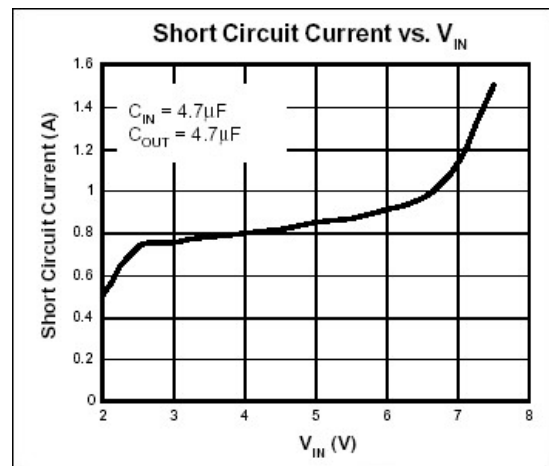
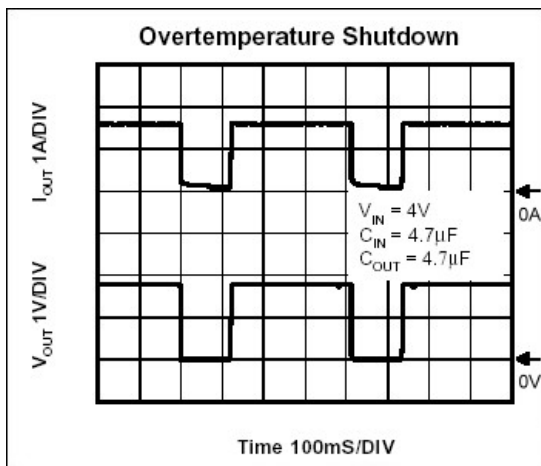
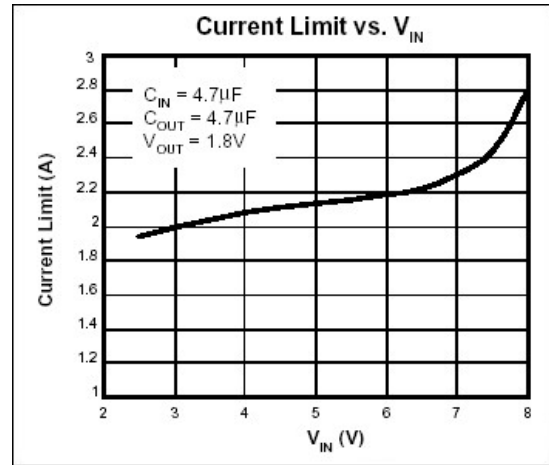
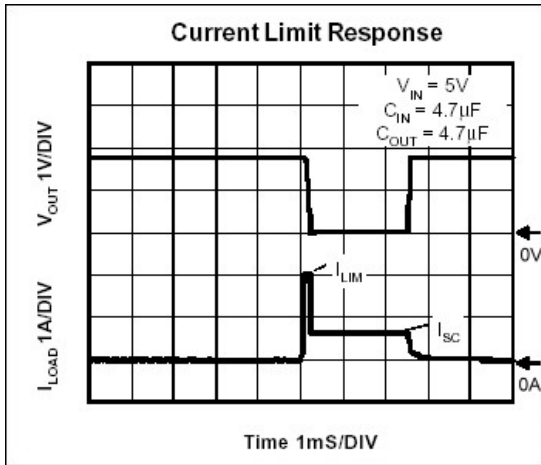

Important Notice:

- All rights are reserved. Reproduction in whole or in part is prohibited without the prior written approval of GTM.
- GTM reserves the right to make changes to its products without notice.
- GTM semiconductor products are not warranted to be suitable for use in life-support Applications, or systems.
- GTM assumes no liability for any consequence of customer product design, infringement of patents, or application assistance.

Head Office And Factory:

- Taiwan: No. 17-1 Tatung Rd. Fu Kou Hsin-Chu Industrial Park, Hsin-Chu, Taiwan, R. O. C.
- TEL : 886-3-597-7061 FAX : 886-3-597-9220, 597-0785
- China: (201203) No.255, Jang-Jiang Tsai-Lueng RD. , Pu-Dung-Hsin District, Shang-Hai City, China
- TEL : 86-21-5895-7671 ~ 4 FAX : 86-21-38950165