

The products listed in this catalog are only a few of the thousands of variations that TUSONIX produces. For custom component design, please contact the factory direct.

Catalog 4000R5
Section 1
Revised 01/27/03



Providing Excellence in EMI/RFI Filtering Components...

TUSONIX, Inc. manufactures thousands of EMC Products featuring an extensive line of EMI/RFI Filters and Capacitors.

We combine Technology, Expertise, Versatility and Innovation to produce the industry's most complete line of ceramic EMI/RFI Filters. TUSONIX draws upon its 50+ years of

manufacturing expertise and an accumulated base of ceramic dielectric technology to provide an ever expanding line of EMI/RFI Filters and Capacitors.

Tusonix products not only set the industry standard but lead the way in the development of tomorrow's EMI Technology.



How to use this Catalog

This Catalog identifies standard parts produced by TUSONIX. Part numbers are listed in sections by mounting style (Solder Mount or Bushing Mount). Bushing parts are listed by circuit configuration and arranged in ascending order with respect to voltage rating at 125°C and then capacitance value.

FILTERS

Filters are assigned a four digit style number followed by a three digit variation number. (Example: 4100-003)

FEED-THRU CAPACITORS

Feed-thru capacitors are assigned a three or four digit style number followed by a three digit variation number, then the EIA Code for temperature characteristic, capacitance and tolerance. (Example: 2482-012-X5U0-272M)

For additional EIA Codes and Tolerances, please see page 21.

Contents

Capacitors	2
Solder Mount Filters	3-8
Bushing Mount Filters	9-20
4-40 Thread	9-10
6-40 Thread	11
6-32 Thread	12
8-32 Thread	13-14
8-36 Thread	15
12-28 Thread	15
12-32 Thread	16
1/4-28 Thread	17
5/16-24 Thread	17
5/16-32 Thread	17
High Voltage	17
Metric Thread	18
Mil Cross Reference	11
Coaxial Broadband	19-20
Standard Hardware Dimensions	20
EIA/Tusonix Tolerance Codes	21
Installation Recommendations	21
General Test Specifications	22

For additional product lines manufactured by TUSONIX, please refer to the back cover of this Catalog.

TUSONIX Capabilities

Manufacturing

TUSONIX utilizes more than 120,000 square feet (11,150 square meters) of manufacturing space, dedicated to providing high quality EMI/RFI products.

In addition to the standard catalog items, TUSONIX has numerous variations of these designs and can custom design a part to meet your particular specifications. TUSONIX maintains a staff of highly skilled Customer Engineers to assist our customers in the design of custom products.

Meeting Customer Requirements

Headquartered in Tucson, Arizona, TUSONIX is devoted to bringing the company's broad product line to an ever expanding world market.

TUSONIX has more than five decades of efficient manufacturing expertise in its corporate heritage, and utilizes sophisticated equipment to provide customers with attractive pricing and full value for the products they purchase.

Circuits Available in this Catalog

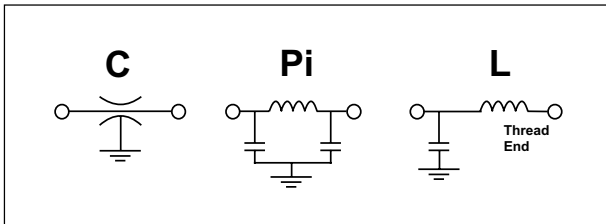

TUSONIX Quality Objective

The timely delivery of quality products which exceed our customers' expectations through the use of effective teamwork and the process of continuous improvement.

TUSONIX Quality

Quality is the key ingredient in all TUSONIX products with approval to MIL-PRF-15733, MIL-PRF-81 and MIL-C-11015. TUSONIX maintains a fully approved Quality Assurance laboratory and relies heavily on Statistical Process Control to monitor critical operations.

TUSONIX

7741 North Business Park Drive
Tucson, Arizona 85743
Ph: 520-744-0400 Fax: 520-744-6155
Website: www.tusonix.com
E-mail: sales@tusonix.com

Solder Mount Feed-Through Capacitors

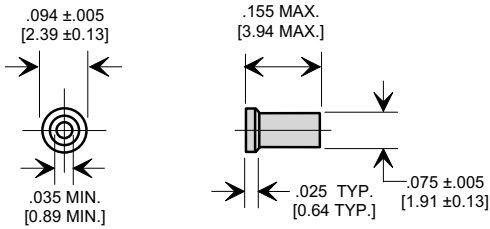

STYLE 1

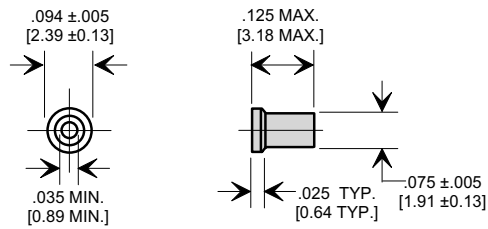

STYLE 2

inches
[mm]

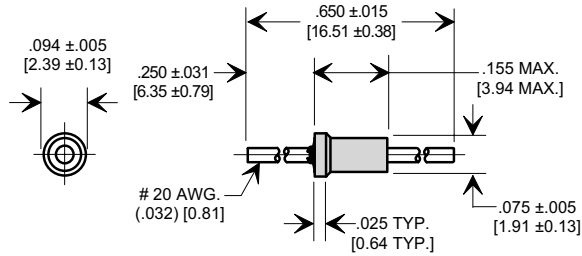

STYLE 3

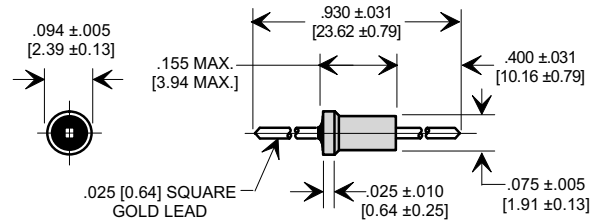

STYLE 4

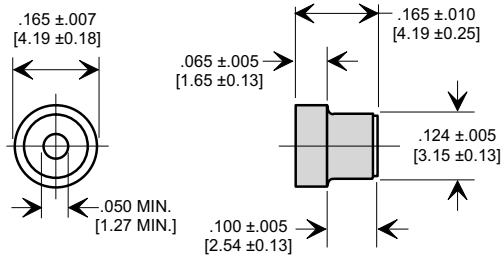

STYLE 5

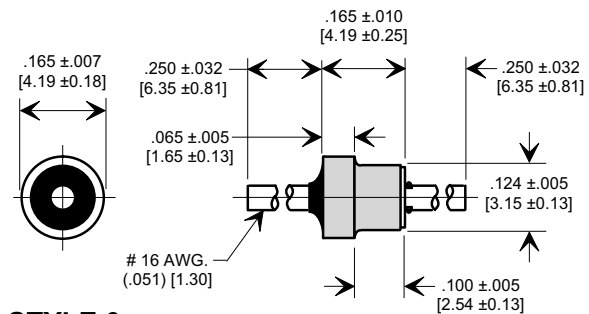

STYLE 6

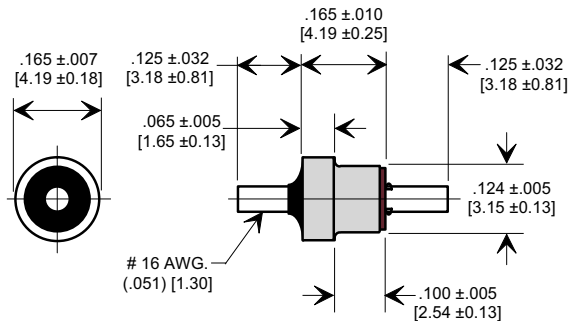

STYLE 7

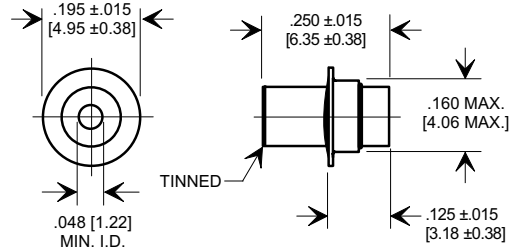

STYLE 8

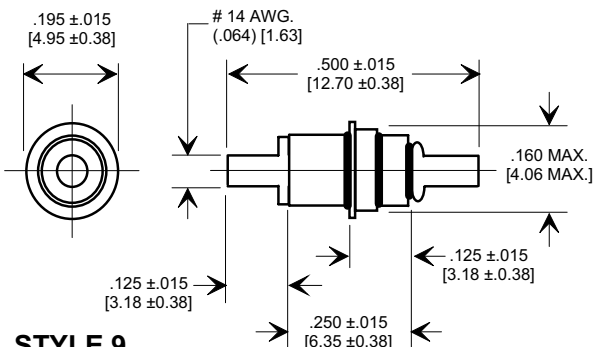

STYLE 9

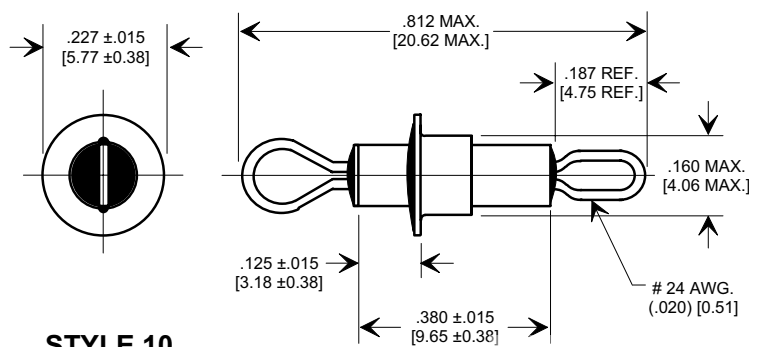

STYLE 10

Solder Mount Feed-Thru Capacitors

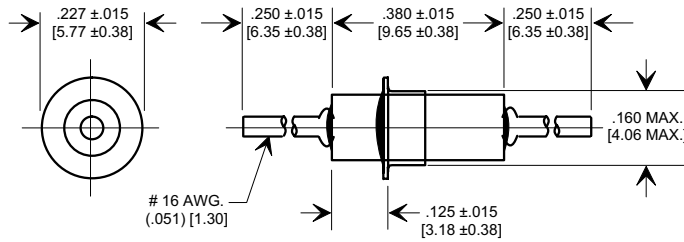

STYLE 11

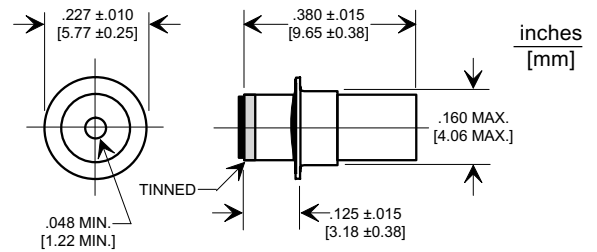

STYLE 12

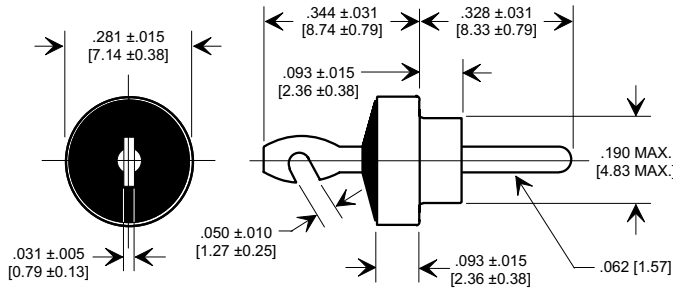

STYLE 13

Series Number	Temperature Range	WVDC	MAX. CAP. Nominal (pF)
2404	Z5, Y5, X5	500	7000
	X7	250	7000
2482	Z5, Y5, X5	300	4000
	X7	150	4000
2450	Z5, Y5, X5	500	1800
	X7	250	1800
2461	Z5, Y5, X5	200	1000
	X7	100	1000
2463	Z5, Y5, X5	200	2000
	X7	100	2000

Notes:
 v #14 AWG Lead 0.064 Dia.

Please see temperature Characteristics and EIA Codes on page 21.

TUSONIX Part Number	Style	Notes	Circuit	Working Voltage (dc)		Capacitance (pF)	Capacitance Tolerance	Current (A)	Typical No-Load Insertion Loss (dB) at 25°C per MIL-Std-220				
				85°C	125°C				1MHz	10MHz	100MHz	1GHz	10GHz
				C Configuration									
2463-001-X5S0-471M	2	--	C	200	--	470	±20%	--	--	--	12	27	27
2463-002-X5S0-471M	3	--	C	200	--	470	±20%	10	--	--	12	27	27
2463-003-X5U0-471P	4	--	C	200	--	470	+100-0%	10	--	--	12	27	27
2461-000-X7V0-102P	5	--	C	--	100	1000	+100-0%	--	--	3	20	35	40
2461-001-X7V0-102AA	6	--	C	--	100	1000	GMV	20	--	3	20	35	40
2461-002-X7V0-102M	7	--	C	--	100	1000	±20%	20	--	3	20	35	40
2463-000-X7U0-152P	1	--	C	--	100	1500	+100-0%	--	--	5	22	35	40
2463-002-X5U0-152P	3	--	C	200	--	1500	+100-0%	10	--	5	22	35	40
2463-003-X5U0-152P	4	--	C	200	--	1500	+100-0%	10	--	5	22	35	40
2482-001-X5U0-471M	9	--	C	300	--	470	±20%	20	--	--	12	27	27
2482-012-X5U0-102M	8	--	C	300	--	1000	±20%	--	--	3	20	35	40
2482-001-X5U0-102M	9	--	C	300	--	1000	±20%	20	--	3	20	35	40
2450-001-X5R0-101K	13	--	C	500	--	100	±10%	20	--	--	3	20	28
2450-001-X5R0-471M	13	--	C	500	--	470	±20%	20	--	--	12	27	27
2404-000-X7R0-471M	11	--	C	--	250	470	±20%	20	--	--	12	27	27
2450-001-X5U0-102P	13	--	C	500	--	1000	+100-0%	20	--	3	20	35	40
2404-000-X5U0-102P	11	--	C	500	--	1000	+100-0%	20	--	3	20	35	40
2404-014-X5U0-102P	12	--	C	500	--	1000	+100-0%	--	--	3	20	35	40
2404-014-X5W0-502M	12	--	C	500	--	5000	±20%	--	--	15	30	45	50
2404-000-X5W0-502Z	11	v	C	500	--	5000	+80-20%	20	--	15	30	45	50
2404-007-X5W0-502Z	10	--	C	500	--	5000	+80-20%	15	--	15	30	45	50

Solder Mount C Filters

4300 Series Miniature EMI Filter MICROWAVE APPLICATIONS:

Oscillators ● Attenuators
Low Noise Amplifiers ● Microwave Filters

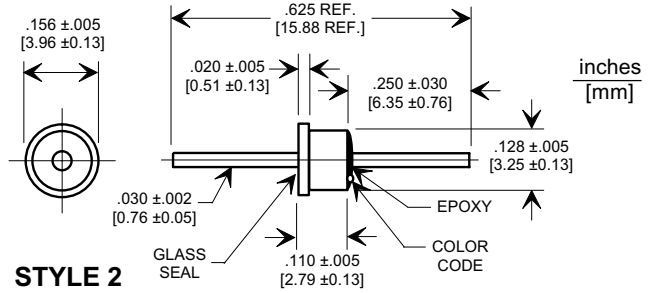
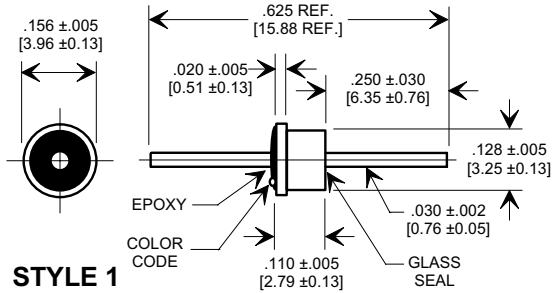

inches
[mm]

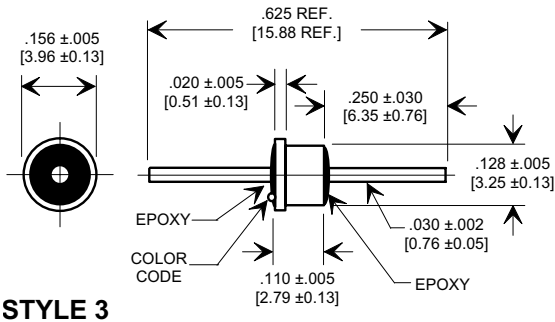

TUSONIX Part Number	Style	Circuit	Working Voltage (dc)		Capacitance (pF)	Capacitance Tolerance	Current (A)	Minimum No-Load Insertion Loss (dB) at 25°C per MIL-Std-220					Color Code
			85°C	125°C				1MHz	10MHz	100MHz	1GHz	10GHz	
Epoxy Sealed Top (flange)/ Glass Sealed Bottom													
4300-005	1	C	70	50	10,000	GMV	5	4	21	35	50	60	BLACK
4300-055	1	C	70	50	10,000	±20%	5	4	21	35	50	60	BLK-GOLD
4300-006	1	C	70	50	15,000	GMV	5	7	20	35	55	60	ORANGE
4300-013	1	C	70	50	27,000	GMV	5	10	28	42	65	65	RED-RED
4300-014	1	C	50	50	50,000	GMV	5	15	35	45	70	--	BLU-BLU
4300-003	1	C	150	100	2700	GMV	5	--	10	25	40	50	RED
4300-053	1	C	150	100	2700	±20%	5	--	10	25	40	50	RED-GOLD
4300-004	1	C	150	100	5000	GMV	5	--	15	30	45	55	YELLOW
4300-054	1	C	150	100	5000	±20%	5	--	15	30	45	55	YEL-GOLD
4300-680	1	C	300	200	5	MAX	5	--	--	--	--	--	BLK-BLK
4300-008	1	C	300	200	10	GMV	5	--	--	--	5	20	VIOLET
4300-009	1	C	300	200	25	GMV	5	--	--	--	10	25	BLUE
4300-000	1	C	300	200	100	GMV	5	--	--	3	20	28	GREEN
4300-050	1	C	300	200	100	±20%	5	--	--	3	20	28	GRN-GOLD
4300-001	1	C	300	200	500	GMV	5	--	--	15	35	40	BROWN
4300-051	1	C	300	200	500	±20%	5	--	--	15	35	40	BRWN-GOLD
4300-007	1	C	300	200	1000	GMV	5	--	5	20	35	45	GRAY
4300-002	1	C	300	200	1200	GMV	5	--	5	20	35	45	WHITE
4300-052	1	C	300	200	1200	±20%	5	--	5	20	35	45	WHT-GOLD

Drawings not to scale.

TUSONIX 4300 Series Miniature EMI Filters

These filters are ideal for applications where small size and high performance are critical. These C configured filters can be glass sealed on either one of the ends for optimal sealing between system compartments or components.

The gold plating on the leads offers excellent conductivity and connective ability using common gold bonding methods. The small package and large range of electrical characteristics of the 4300 Series make it an effective solution for a variety of microwave applications.



TUSONIX Part Number	Style	Circuit	Working Voltage (dc)		Capacitance (pF)	Capacitance Tolerance	Current (A)	Minimum No-Load Insertion Loss (dB) at 25°C per MIL-Std-220					Color Code
			85°C	125°C				1MHz	10MHz	100MHz	1GHz	10GHz	
Glass Sealed Top (flange)/ Epoxy Sealed Bottom													
4300-025	2	C	70	50	10,000	GMV	5	4	21	35	50	60	BLACK
4300-065	2	C	70	50	10,000	±20%	5	4	21	35	50	60	BLK-GOLD
4300-026	2	C	70	50	15,000	GMV	5	7	20	35	55	60	ORANGE
4300-031	2	C	70	50	27,000	GMV	5	10	28	42	65	65	RED-RED
4300-034	2	C	50	50	50,000	GMV	5	15	35	45	70	--	BLU-BLU
4300-023	2	C	150	100	2700	GMV	5	--	10	25	40	50	RED
4300-063	2	C	150	100	2700	±20%	5	--	10	25	40	50	RED-GOLD
4300-024	2	C	150	100	5000	GMV	5	--	15	30	45	55	YELLOW
4300-064	2	C	150	100	5000	±20%	5	--	15	30	45	55	YEL-GOLD
4300-681	2	C	300	200	5	MAX	5	--	--	--	--	--	BLK-BLK
4300-028	2	C	300	200	10	GMV	5	--	--	--	5	20	VIOLET
4300-029	2	C	300	200	25	GMV	5	--	--	--	10	25	BLUE
4300-020	2	C	300	200	100	GMV	5	--	--	3	20	28	GREEN
4300-060	2	C	300	200	100	±20%	5	--	--	3	20	28	GRN-GOLD
4300-021	2	C	300	200	500	GMV	5	--	--	15	35	40	BROWN
4300-061	2	C	300	200	500	±20%	5	--	--	15	35	40	BRWN-GOLD
4300-027	2	C	300	200	1000	GMV	5	--	5	20	35	45	GRAY
4300-022	2	C	300	200	1200	GMV	5	--	5	20	35	45	WHITE
4300-062	2	C	300	200	1200	±20%	5	--	5	20	35	45	WHT-GOLD
Epoxy Sealed Top (flange)/ Epoxy Sealed Bottom													
4302-005	3	C	70	50	10,000	GMV	10	4	21	35	50	60	BLACK
4302-006	3	C	70	50	15,000	GMV	10	7	20	35	55	60	ORANGE
4302-013	3	C	70	50	27,000	GMV	10	10	28	42	65	65	RED-RED
4302-014	3	C	50	50	50,000	GMV	10	15	35	45	70	--	BLU-BLU
4302-003	3	C	150	100	2700	GMV	10	--	10	25	40	50	RED
4302-004	3	C	150	100	5000	GMV	10	--	15	30	45	55	YELLOW
4302-680	3	C	300	200	5	MAX	10	--	--	--	--	--	BLK-BLK
4302-008	3	C	300	200	10	GMV	10	--	--	--	5	20	VIOLET
4302-009	3	C	300	200	25	GMV	10	--	--	--	10	25	BLUE
4302-000	3	C	300	200	100	GMV	10	--	--	3	20	28	GREEN
4302-001	3	C	300	200	500	GMV	10	--	--	15	35	40	BROWN
4302-007	3	C	300	200	1000	GMV	10	--	5	20	35	45	GRAY
4302-002	3	C	300	200	1200	GMV	10	--	5	20	35	45	WHITE

Solder Mount Pi Filters

inches
[mm]

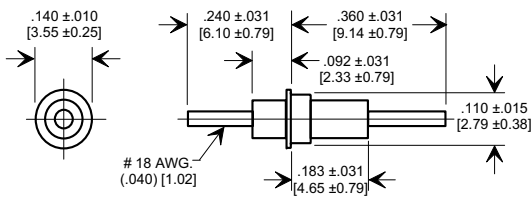

STYLE 1

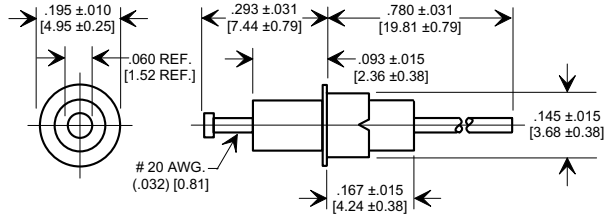

STYLE 2

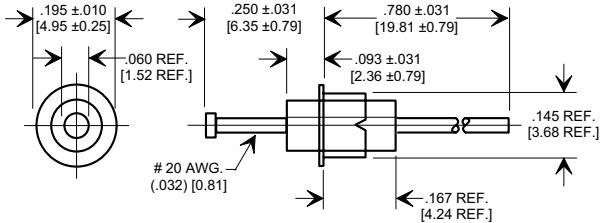

STYLE 3

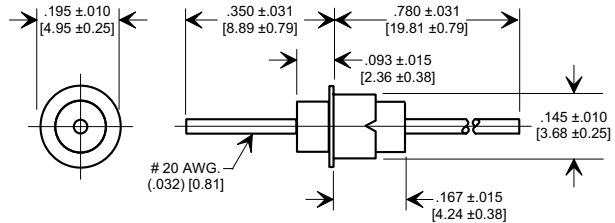

STYLE 4

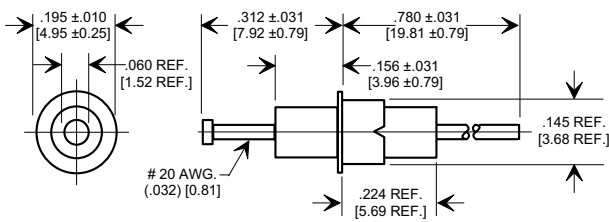

STYLE 5

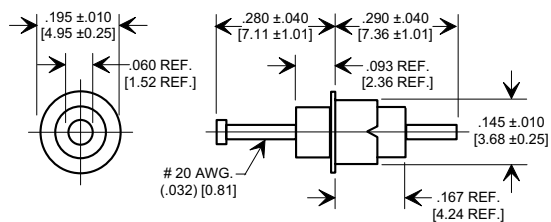

STYLE 6

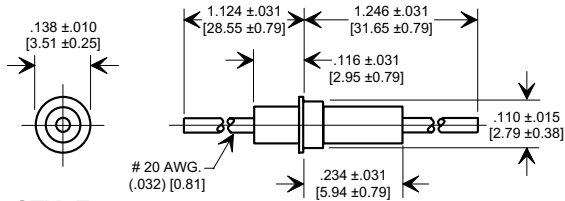

STYLE 7

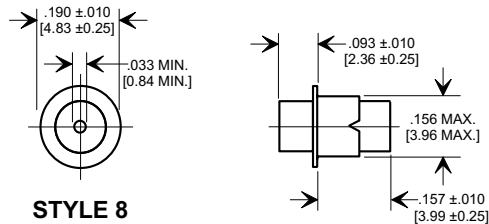

STYLE 8

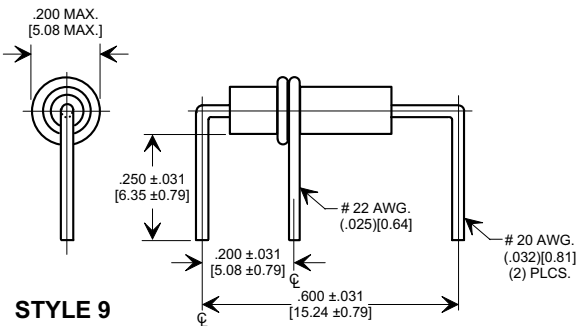

STYLE 9

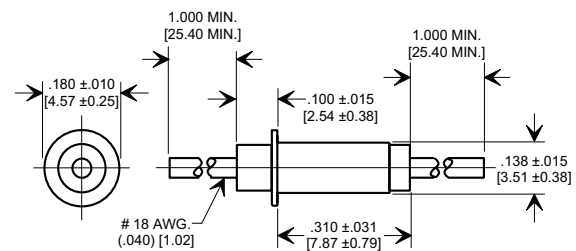

STYLE 10

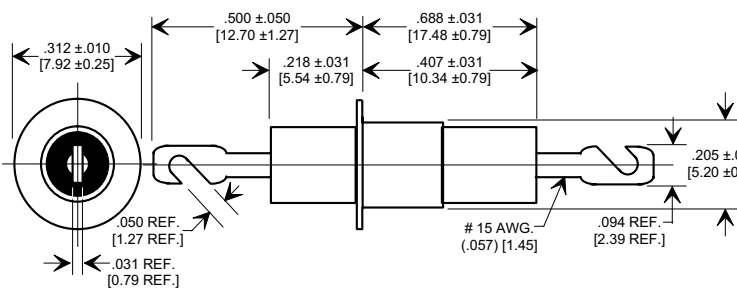

STYLE 11

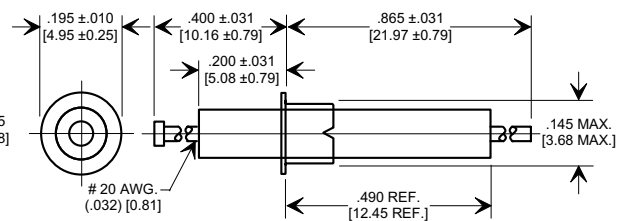

STYLE 12

Solder Mount Pi Filters

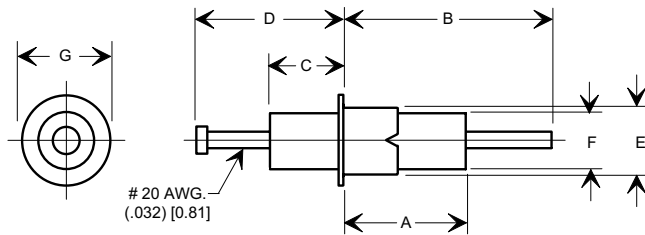

STYLE 13 THROUGH 19

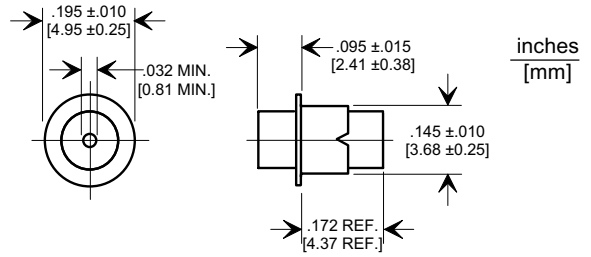

STYLE 20

DIMENSIONS FOR STYLES 13 THROUGH 19

Style Number	MIL-PRF-15733	DIM. A	DIM. B	DIM. C	DIM. D	DIM. E	DIM. F	DIM. G
13	/62-0003	.272 ± .025 [6.91 ± 0.64]	.438 ± .062 [11.13 ± 1.57]	.156 ± .015 [3.96 ± 0.38]	.312 ± .031 [7.92 ± 0.79]	.145 ± .015 [3.68 ± 0.38]	----	.190 ± .015 [4.83 ± 0.38]
14	/62-0004	.151 ± .031 [3.84 ± 0.79]	.780 ± .031 [19.81 ± 0.79]	.093 ± .031 [2.36 ± 0.79]	.273 ± .031 [6.93 ± 0.79]	.145 ± .015 [3.68 ± 0.38]	----	.196 ± .007 [4.98 ± 0.18]
15	/51-0002	.226 ± .022 [5.74 ± 0.56]	.780 ± .031 [19.81 ± 0.79]	.164 ± .022 [4.16 ± 0.56]	.312 ± .031 [7.92 ± 0.79]	.145 ± .015 [3.68 ± 0.38]	----	.203 ± .015 [5.16 ± 0.38]
16	/33-0001	.170 ± .027 [4.32 ± 0.69]	.780 ± .031 [19.81 ± 0.79]	.093 ± .015 [2.36 ± 0.38]	.288 ± .015 [7.32 ± 0.38]	----	.125 MAX [3.18 MAX]	.190 ± .015 [4.83 ± 0.38]
16	/33-0002♦	.250 ± .031 [6.35 ± 0.79]	.406 ± .031 [10.31 ± 0.79]	.156 ± .031 [3.96 ± 0.79]	.312 ± .031 [7.92 ± 0.79]	.145 ± .015 [3.68 ± 0.38]	.125 ± .015 [3.18 ± 0.38]	.190 ± .015 [4.83 ± 0.38]
17	/62-0001	.231 ± .046 [5.87 ± 1.17]	1.231 ± .077 [31.27 ± 1.96]	.109 ± .031 [2.77 ± 0.79]	1.109 ± .062 [28.17 ± 1.57]	.110 ± .015 [2.79 ± 0.38]	----	.143 ± .010 [3.63 ± 0.25]
18	/62-0002♦	.250 ± .031 [6.35 ± 0.79]	.406 ± .031 [10.31 ± 0.79]	.156 ± .031 [3.96 ± 0.79]	.312 ± .031 [7.92 ± 0.79]	.142 ± .007 [3.61 ± 0.18]	.122 ± .017 [3.10 ± 0.43]	.195 ± .010 [4.95 ± 0.25]
19	/51-0001	.250 ± .031 [6.35 ± 0.79]	.406 ± .031 [10.31 ± 0.79]	.156 ± .031 [3.96 ± 0.79]	.312 ± .031 [7.92 ± 0.79]	.142 ± .007 [3.61 ± 0.18]	.122 ± .017 [3.10 ± 0.43]	.195 ± .010 [4.95 ± 0.25]

Notes:

* Straight Lead

TUSONIX Part Number	MIL-PRF-15733 Number	Style	Notes	Circuit	Working Voltage (dc)		Capacitance (pF)	Capacitance Tolerance	Current (A)	Minimum No-Load Insertion Loss (dB) at 25°C per MIL-Std-220					
					85°C	125°C				1MHz	10MHz	100MHz	1GHz	10GHz	
Pi Configuration															
4100-003	--	1	--	Pi	125	50	3000	GMV	15	--	7	50	65	60	
4101-505	/62-0003	13	--	Pi	--	70	1500	GMV	10	--	--	50	65	65	
4151-000	--	3	--	Pi	100	70	12,000	GMV	10	--	25	70	65	65	
4151-500	/62-0004	14	--	Pi	--	70	12,000	GMV	10	--	22	70	--	65	
4151-001	--	5	--	Pi	100	70	22,000	GMV	10	--	35	70	70	70	
4151-501	/51-0002	15	--	Pi	--	70	22,000	GMV	10	--	25	70	70	70	
4151-003	--	12	--	Pi	100	70	60,000	GMV	10	--	60	75	75	75	
4100-000	--	7	--	Pi	250	125	1500	GMV	10	--	6	45	60	60	
4101-000	--	20	--	Pi	250	125	1750	GMV	10	--	5	35	50	50	
4101-002	--	2	--	Pi	250	125	1750	GMV	10	--	5	50	60	60	
4101-003	--	4	--	Pi	250	125	1750	GMV	10	--	5	50	60	60	
4101-004	--	6	--	Pi	250	125	1750	GMV	10	--	5	50	60	60	
4101-502	/33-0001	16	--	Pi	--	125	1750	GMV	10	--	--	50	60	60	
4101-503	/33-0002	16	*	Pi	--	125	1750	GMV	10	--	--	50	60	60	
4101-500	/66-0001	8	--	Pi	--	125	1750	GMV	10	--	5	35	50	50	
4100-056	--	9	--	Pi	250ac	200dc	1000	±20%	10	--	3	20	55	--	
4100-002	--	1	--	Pi	350	200	1500	GMV	15	--	5	25	60	60	
4101-001	--	17	--	Pi	350	200	1500	GMV	10	--	3	45	70	70	
4101-501	/62-0001	17	--	Pi	--	200	1500	GMV	10	--	3	45	70	70	
4100-500	/62-0002	18	*	Pi	--	200	1500	GMV	10	--	5	45	70	--	
4100-057	--	9	--	Pi	250ac	200dc	1500	GMV	10	--	5	45	70	--	
4102-000	--	10	--	Pi	350	200	3000	GMV	10	--	8	55	65	65	
4100-053	--	9	--	Pi	250ac	200dc	5000	GMV	10	--	18	60	70	--	
4101-504	/51-0001	19	--	Pi	200	--	5500	GMV	10	--	15	55	70	70	
4106-000	--	11	--	Pi	500dc 350ac	500dc 350ac	3000	GMV	25	--	--	50	50	50	
4106-001	--	11	--	Pi	1000	500	4500	GMV	25	--	8	50	70	70	