

● **Features :**

1. 0.56 inch (14.20mm) Digit Height.
2. Continuous uniform segments.
3. Low power requirement.
4. Excellent characters appearance.
5. Solid state reliability.
6. Categorized for luminous intensity.
7. Direct drive common anode.

● **Description :**

1. The BS-A514RD is a 14.2mm(0.56") high single digit seven segments display.
2. This product use hi-eff red chips, which are made from GaAsP on GaP substrate.
3. This product have a black face and white segments.
4. This product doesn't contain restriction substance, comply ROHS standard

● **Package Dimensions :**

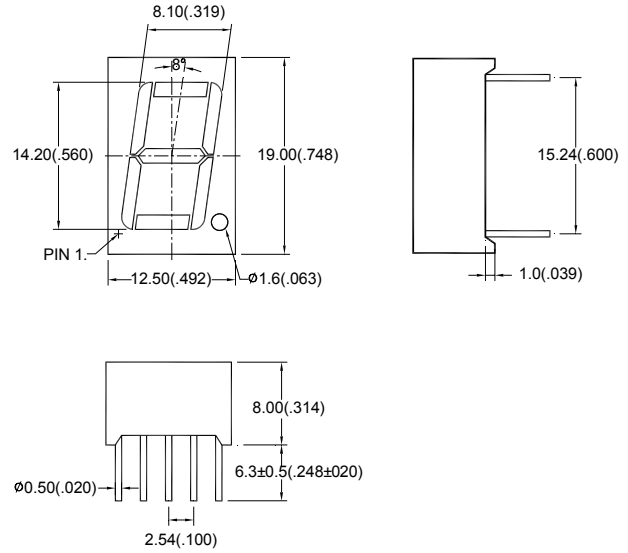

Notes:

1. All dimensions are in millimeters(inches).
2. Tolerance is $\pm 0.25\text{mm}(.01\text{'})$ unless otherwise specified.
3. Specifications are subject to change without notice.

● **Internal Circuit Diagram :**

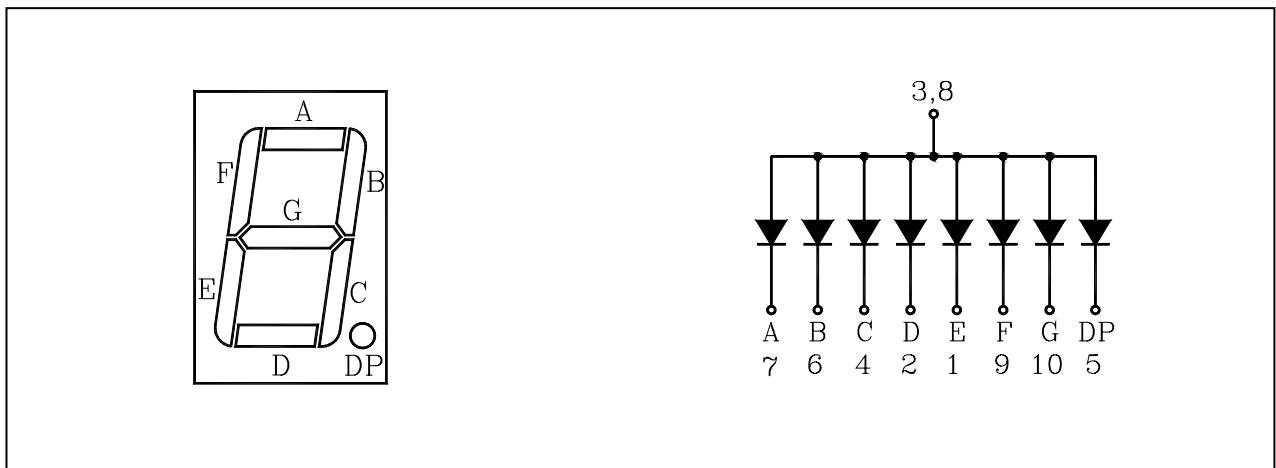

● **Absolute Maximum Ratings(Ta=25°C)**

Parameter	Symbol	Rating	Unit
Power Dissipation Per Segment	Pd	80	mW
Forward Current Per Segment	I _F	30	mA
Peak Forward Current Per Segment	I _{FP} (Duty 1/10, 1KHZ)	150	mA
Reverse Voltage Per Segment	V _R	5	V
Operating Temperature	Topr	-40°C~80°C	-
Storage Temperature	Tstg	-40°C~85°C	-
Soldering Temperature (1/16" From Body)	Tsol	260°C For 5 Seconds	-

● **Electrical And Optical Characteristics(Ta=25°C)**

Parameter	Symbol	Condition	Min.	Typ.	Max.	Unit
Forward Voltage Per Segment	V _f	I _F =10mA	-	1.9	2.5	V
Luminous Intensity Per Segment	I _v	I _F =10mA	-	3.0	-	mcd
Reverse Current Per Segment	I _R	V _R =5V	-	-	100	μA
Peak Wave Length	λ _p	I _F =10mA	-	640	-	nm
Dominant Wave Length	λ _d	I _F =10mA	626	-	636	nm
Spectral Line Half-width	Δλ	I _F =10mA	-	40	-	nm

● Typical Electro-Optical Characteristics Curves

(25°C Ambient Temperature Unless Otherwise Noted)

Fig.1 Relative Radiant Intensity VS. Wavelength

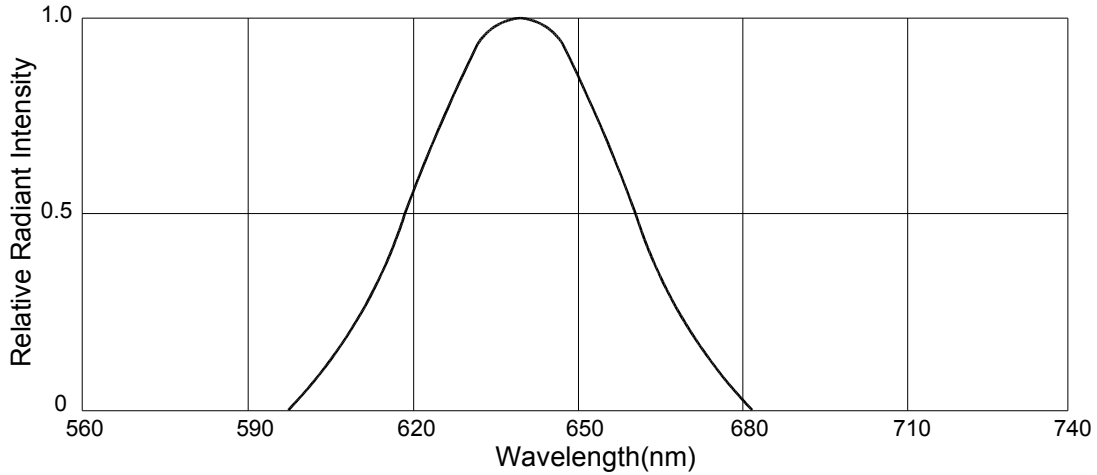

Fig.2 Forward Current VS. Forward Voltage

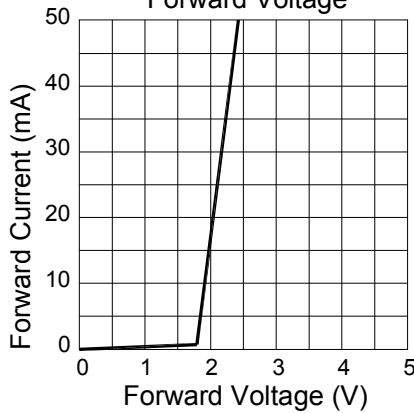

Fig.3 Relative Luminous Intensity VS. Ambient Temperature

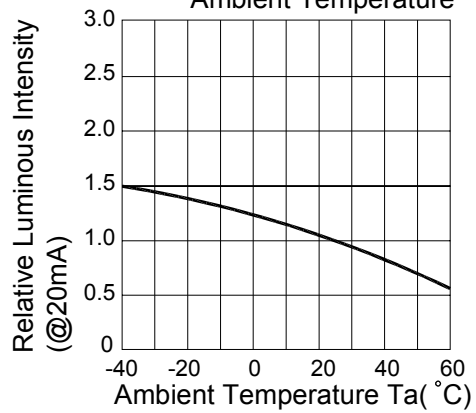

Fig.4 Relative Luminous Intensity VS. Forward Current

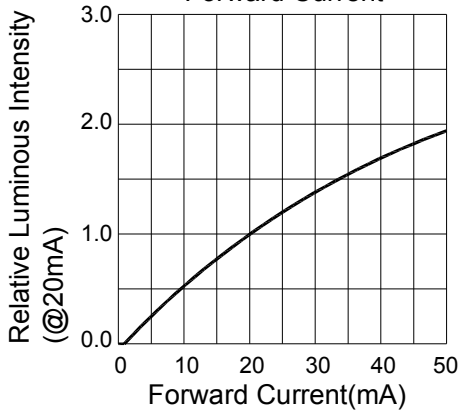
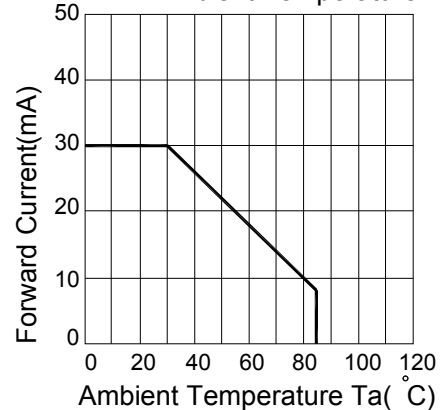

Fig.5 Forward Current Derating Curve VS. Ambient Temperature



● **Bin Limits**

1. Intensity Bin Limits (At $I_F = 10\text{mA}$)

Bin Code	Min. (mcd)	Max. (mcd)
K	2.04	2.76
L	2.66	3.59
M	3.46	4.67

● Bin : x

