

XPT IGBT

Copack

$I_{C25} = 20 \text{ A}$
 $V_{CES} = 1200 \text{ V}$
 $V_{CE(sat)typ} = 1.8 \text{ V}$

Part number

IXA12IF1200HB

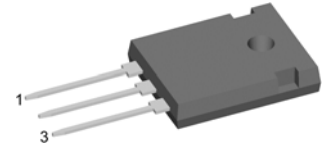
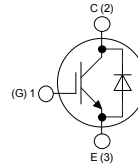

Features / Advantages:

- Easy paralleling due to the positive temperature coefficient of the on-state voltage
- Rugged XPT design (Xtreme light Punch Through) results in:
 - short circuit rated for 10 μsec .
 - very low gate charge
 - low EMI
 - square RBSOA @ 3x I_c
- Thin wafer technology combined with the XPT design results in a competitive low $V_{CE(sat)}$
- SONIC™ diode
 - fast and soft reverse recovery
 - low operating forward voltage

Applications:

- AC motor drives
- Solar inverter
- Medical equipment
- Uninterruptible power supply
- Air-conditioning systems
- Welding equipment
- Switched-mode and resonant-mode power supplies
- Inductive heating, cookers

Package:

- Housing: TO-247
- Industry standard outline
- Epoxy meets UL 94V-0
- RoHS compliant

IGBT

Symbol	Definition	Conditions	Ratings			Unit
			min.	typ.	max.	
V_{CES}	Collector emitter voltage	$V_{GE} = 0 \text{ V}$			1200	V
V_{GES}	Maximum DC gate voltage				± 20	V
I_{C25}	Collector current				20	A
I_{C90}					13	A
P_{tot}	Total power dissipation				85	W
I_{CES}	Collector emitter leakage current	$V_{CE} = V_{CES} ; V_{GE} = 0 \text{ V}$			0.1	mA
				0.1		mA
I_{GES}	Gate emitter leakage current	$V_{CE} = 0 \text{ V}; V_{GE} = \pm 20 \text{ V}$			500	nA
$V_{CE(sat)}$	Collector emitter saturation voltage	$I_C = 9 \text{ A}; V_{GE} = 15 \text{ V}$		1.8	2.1	V
				2.1		V
$V_{GE(th)}$	Gate emitter threshold voltage	$I_C = 0.3 \text{ mA}; V_{GE} = V_{CE}$	5.5	6	6.5	V
Q_{Gon}	Total gate charge	$V_{CE} = 600 \text{ V}; V_{GE} = 15 \text{ V}; I_C = 10 \text{ A}$		27		nC
$t_{d(on)}$	Turn-on delay time			70		ns
t_r	Current rise time			40		ns
$t_{d(off)}$	Turn-off delay time	Inductive load		250		ns
t_f	Current fall time	$V_{CE} = 600 \text{ V}; I_C = 10 \text{ A}$		100		ns
E_{on}	Turn-on energy per pulse	$V_{GE} = \pm 15 \text{ V}; R_G = 100 \Omega$	$T_{VJ} = 125^\circ\text{C}$	1.1		mJ
E_{off}	Turn-off energy per pulse			1.1		mJ
RBSOA	Reverse bias safe operation area	$V_{GE} = 15 \text{ V}; R_G = 100 \Omega$ $V_{CEK} = 1200 \text{ V}$	$T_{VJ} = 125^\circ\text{C}$		30	A
SCSOA	Short circuit safe operation area					
t_{sc}	Short circuit duration	$V_{CE} = 900 \text{ V}; V_{GE} = \pm 15 \text{ V}$	$T_{VJ} = 125^\circ\text{C}$		10	μs
I_{sc}	Short circuit current	$R_G = 100 \Omega$; non-repetitive			40	A
R_{thJC}	Thermal resistance junction to case				1.5	K/W

Diode

Symbol	Definition	Conditions	Ratings			Unit
			min.	typ.	max.	
I_{F25}	Forward current	$T_C = 25^\circ\text{C}$			22	A
I_{F90}		$T_C = 90^\circ\text{C}$			14	A
V_F	Forward voltage	$I_F = 10\text{ A}$	$T_{VJ} = 25^\circ\text{C}$	1.95	2.2	V
			$T_{VJ} = 125^\circ\text{C}$	1.85		V
Q_{rr}	Reverse recovery charge	$V_R = 600\text{V};$ $di_F/dt = -\quad\quad\quad\text{A}/\mu\text{s};$ $I_F = 10\text{ A}$		tbd		μC
I_{RM}	Maximum reverse recovery current			tbd		A
t_{rr}	Reverse recovery time			tbd		ns
$E_{rec(off)}$	Reverse recovery losses at turn-off			tbd		mJ
R_{thJC}	Thermal resistance junction to case				1.8	K/W

Equivalent Circuits for Simulation

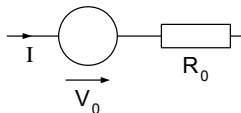

Symbol	Definition		Ratings			Unit
			min.	typ.	max.	
V_0	IGBT	$T_{VJ} = 150^\circ\text{C}$			1.1	V
R_0					153	m Ω
V_0	Diode	$T_{VJ} = 150^\circ\text{C}$			1.1	V
R_0					90	m Ω

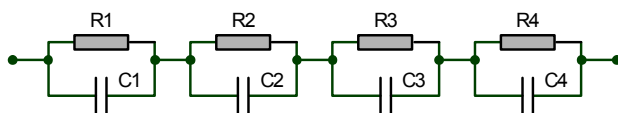

$$Z_{th}(t) = \sum_{i=1}^n \left[R_i \cdot \left(1 - \exp\left(-\frac{t}{\tau_i}\right) \right) \right]$$

$$\tau_i = R_i \cdot C_i$$

	IGBT	Diode
R_1	tbd	tbd
R_2	tbd	tbd
R_3	tbd	tbd
R_4	tbd	tbd
τ_1	tbd	tbd
τ_2	tbd	tbd
τ_3	tbd	tbd
τ_4	tbd	tbd

Package TO-247

Symbol	Definition	Conditions	Ratings			Unit
			min.	typ.	max.	
T_{VJ}	Virtual junction temperature		-55		150	°C
T_{stg}	Storage temperature		-55		150	°C
R_{thCH}	Thermal resistance case to heatsink			0.25		K/W
Weight				6		g
M_D	Mounting torque		0.8		1.2	Nm
F_c	Mounting force with clip		20		120	N

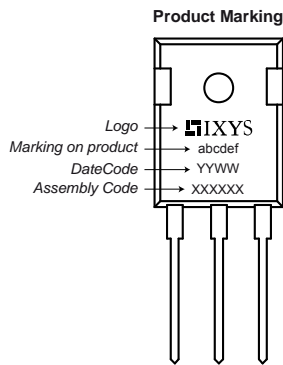

Part number

I = IGBT
 X = XPT IGBT
 A = Gen 1 / std
 12 = Current Rating [A]
 IF = Copack
 1200 = Reverse Voltage [V]
 HB = TO-247AD (3)

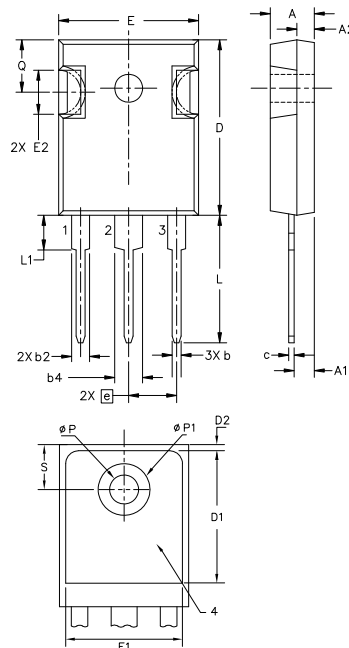
Ordering	Part Name	Marking on Product	Delivering Mode	Base Qty	Code Key
Standard	IXA 12 IF 1200 HB	IXA12IF1200HB			

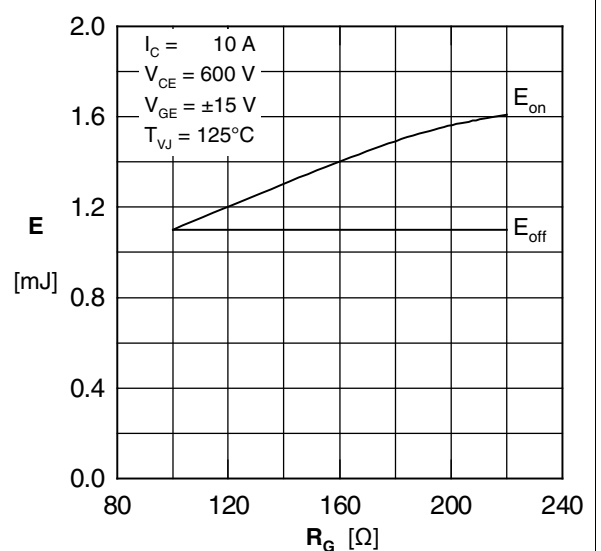
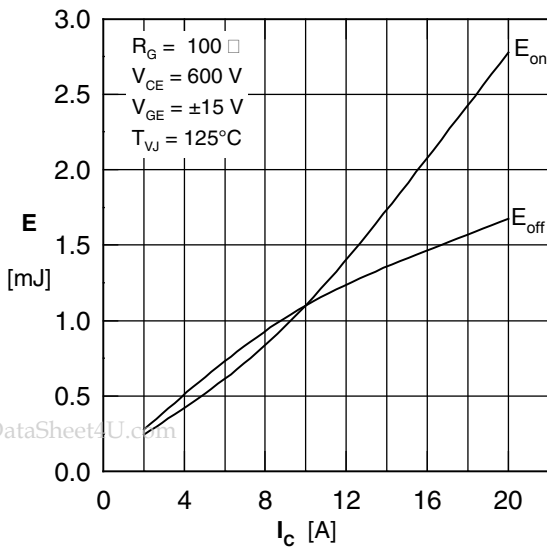
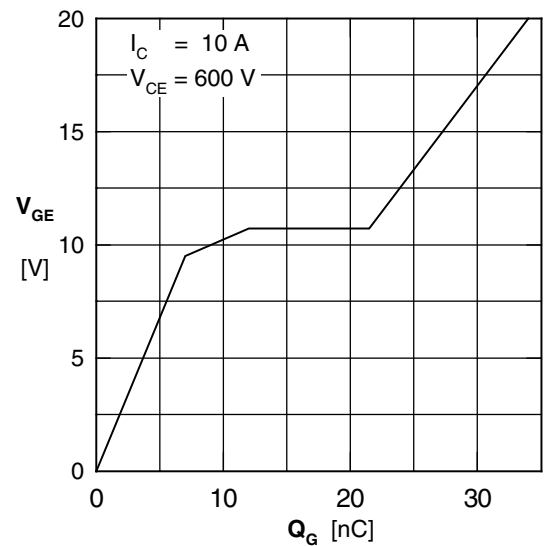
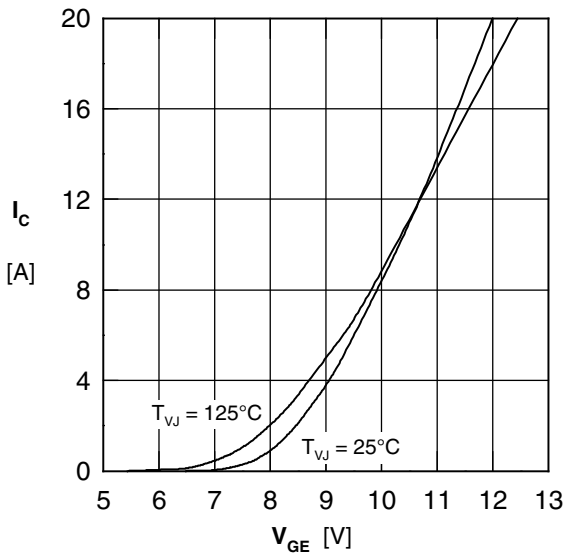
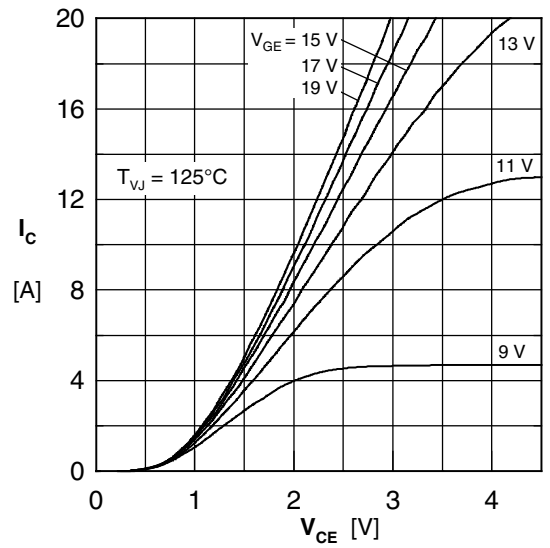
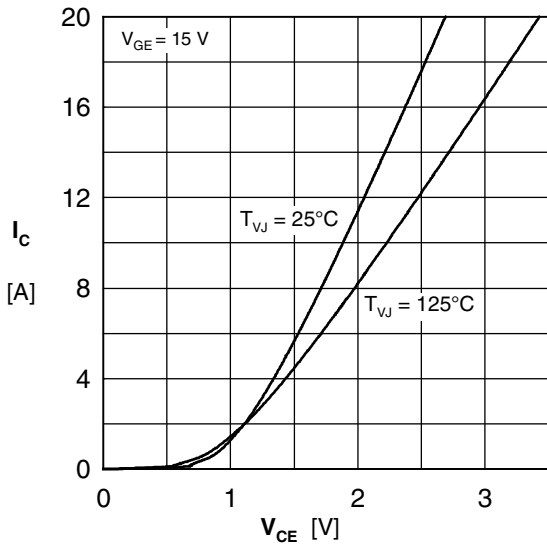

Sym.	Inches		Millimeter	
	min.	max.	min.	max.
A	0.185	0.209	4.70	5.30
A1	0.087	0.102	2.21	2.59
A2	0.059	0.098	1.50	2.49
D	0.819	0.845	20.79	21.45
E	0.610	0.640	15.48	16.24
E2	0.170	0.216	4.31	5.48
e	0.215 BSC		5.46 BSC	
L	0.780	0.800	19.80	20.30
L1	-	0.177	-	4.49
Ø P	0.140	0.144	3.55	3.65
Q	0.212	0.244	5.38	6.19
S	0.242 BSC		6.14 BSC	
b	0.039	0.055	0.99	1.40
b2	0.065	0.094	1.65	2.39
b4	0.102	0.135	2.59	3.43
c	0.015	0.035	0.38	0.89
D1	0.515	-	13.07	-
D2	0.020	0.053	0.51	1.35
E1	0.530	-	13.45	-
Ø P1	-	0.29	-	7.39



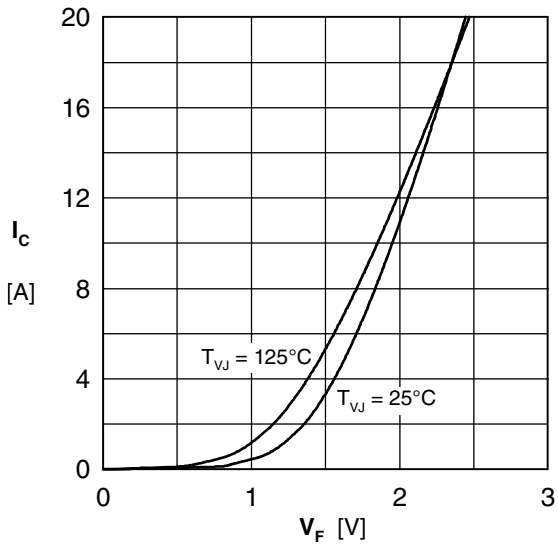

Fig. 7 Typ. forward characteristic