

Surface Mount N-Channel Enhancement Mode MOSFET

 Lead(Pb)-Free

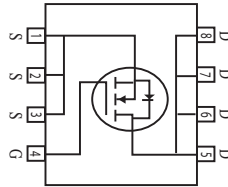

DRAIN CURRENT
11.5 AMPERES
DRAIN SOURCE VOLTAGE
30 VOLTAGE

Description:

The WTK6680 provide the designer with the best combination of fast switching, ruggedized device design, low on-resistance and cost-effectiveness.

The SOP-8 package is universally preferred for all commercial-industrial surface mount applications and suited for low voltage applications such as DC/DC converters.

Features:

- *Low On-Resistance
- *High Vgs Max Rating Voltage
- *Surface Mount Package

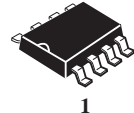

1

SOP-8

Absolute Maximum Ratings

Parameter	Symbol	Ratings	Unit
Drain-Source Voltage	V_{DS}	30	V
Gate-Source Voltage	V_{GS}	± 20	V
Continuous Drain Current ³	$I_D @ TA=25^\circ C$	11.5	A
Continuous Drain Current ³	$I_D @ TA=70^\circ C$	9.5	A
Pulsed Drain Current ¹	I_{DM}	50	A
Total Power Dissipation	$P_D @ TA=25^\circ C$	2.5	W
Linear Derating Factor		0.02	W/ $^\circ C$
Operating Junction and Storage Temperature Range	T_j, T_{stg}	-55 ~ +150	$^\circ C$

Device Marking

WTK6680 = 6680SC

Electrical Characteristics (T_j = 25°C unless otherwise specified)

Parameter	Symbol	Min.	Typ.	Max.	Unit	Test Conditions
Drain-Source Breakdown Voltage	BV _{DSS}	30	-	-	V	V _{GS} =0, I _D =250uA
Breakdown Voltage Temperature Coefficient	ΔBV _{DSS} / ΔT _j	-	0.02	-	V/°C	Reference to 25°C, I _D =1mA
Gate Threshold Voltage	V _{GS(th)}	1.0	-	3.0	V	V _{DS} =V _{GS} , I _D =250uA
Forward Transconductance	g _{fs}	-	30	-	S	V _{DS} =15V, I _D =11.5A
Gate-Source Leakage Current	I _{GSS}	-	-	±100	nA	V _{GS} = ±20V
Drain-Source Leakage Current(T _j =25°C)	I _{DSS}	-	-	1	uA	V _{DS} =30V, V _{GS} =0
Drain-Source Leakage Current(T _j =70°C)		-	-	25	uA	V _{DS} =24V, V _{GS} =0
Static Drain-Source On-Resistance ²	R _{DS(ON)}	-	-	11	mΩ	V _{GS} =10V, I _D =11.5A
		-	-	18		V _{GS} =4.5V, I _D =9.5A
Total Gate Charge ²	Q _g	-	16.8	-	nC	I _D =11.5A V _{DS} =15V V _{GS} =5V
Gate-Source Charge	Q _{gs}	-	4.2	-		
Gate-Drain ("Miller") Charge	Q _{gd}	-	8	-		
Turn-on Delay Time ²	T _{d(on)}	-	8.9	-	ns	V _{DS} =15V I _D =1A V _{GS} =10V R _G =5.5Ω R _D =10Ω
Rise Time	T _r	-	7.3	-		
Turn-off Delay Time	T _{d(off)}	-	25.6	-		
Fall Time	T _f	-	18.6	-		
Input Capacitance	C _{iss}	-	1450	-	pF	V _{GS} =0V V _{DS} =25V f=1.0MHz
Output Capacitance	C _{oss}	-	285	-		
Reverse Transfer Capacitance	C _{rss}	-	180	-		

Source-Drain Diode

Parameter	Symbol	Min.	Typ.	Max.	Unit	Test Conditions
Forward On Voltage ²	V _{SD}	-	-	1.3	V	I _S =3.5A, V _{GS} =0V, T _j =25°C
Continuous Source Current (Body Diode)	I _S	-	-	1.92	A	V _D =V _G =0V, V _S =1.3V

Notes: 1. Pulse width limited by Max. junction temperature.

2. Pulse width ≤ 300us, duty cycle ≤ 2%.

3. Surface mounted on 1 in² copper pad of FR4 board; 125°C/W when mounted on Min. copper pad.

Characteristics Curve

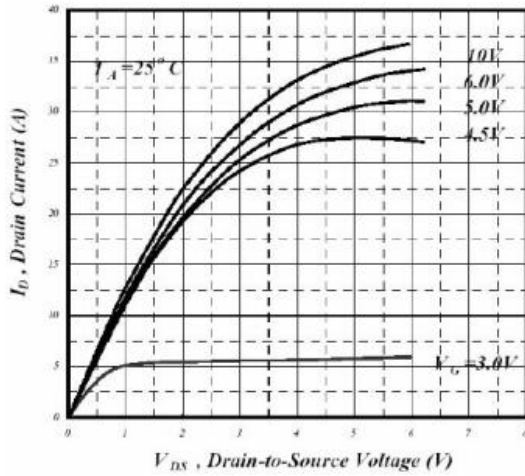

Fig 1. Typical Output Characteristics

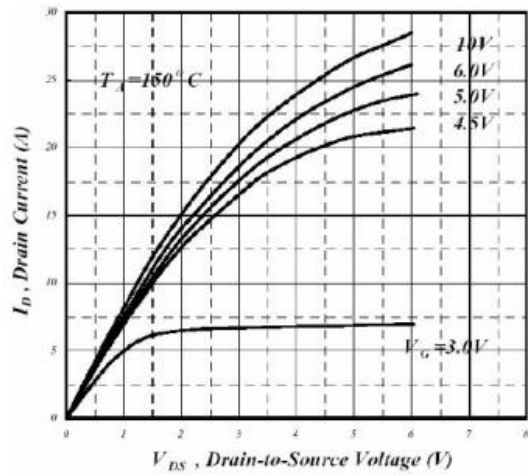

Fig 2. Typical Output Characteristics

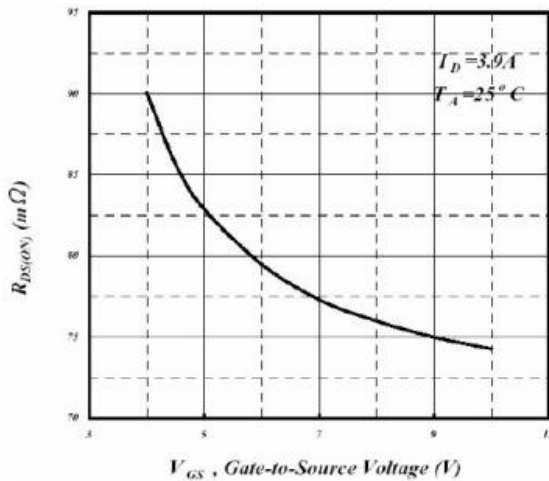

Fig 3. On-Resistance v.s. Gate Voltage

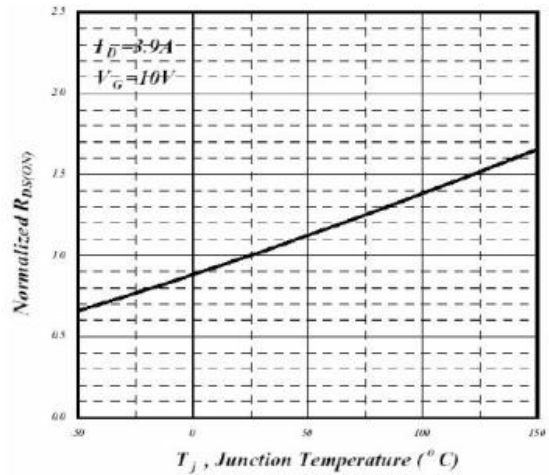

Fig 4. Normalized On-Resistance v.s. Junction Temperature

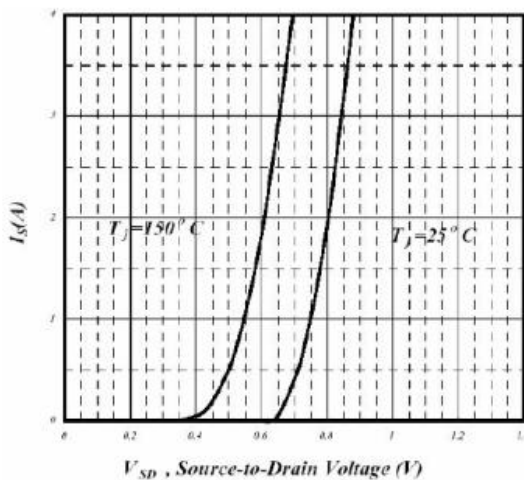

Fig 5. Forward Characteristics of Reverse Diode

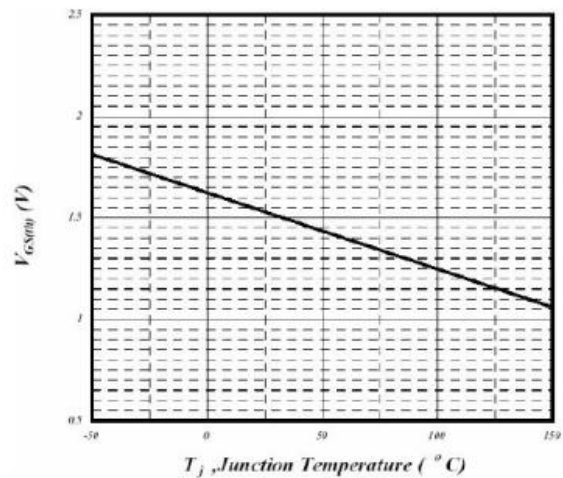

Fig 6. Gate Threshold Voltage v.s. Junction Temperature

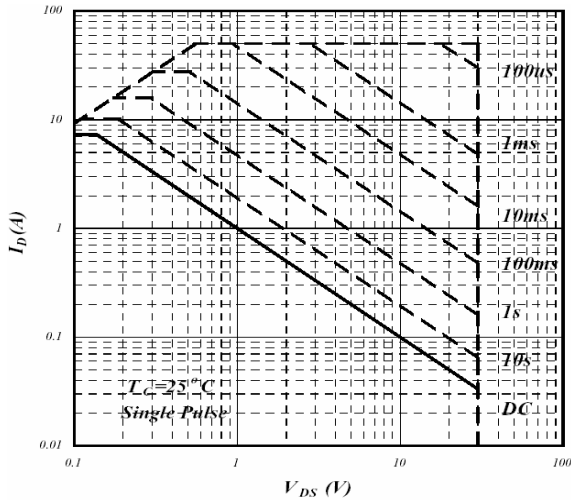

Fig 7. Maximum Safe Operating Area

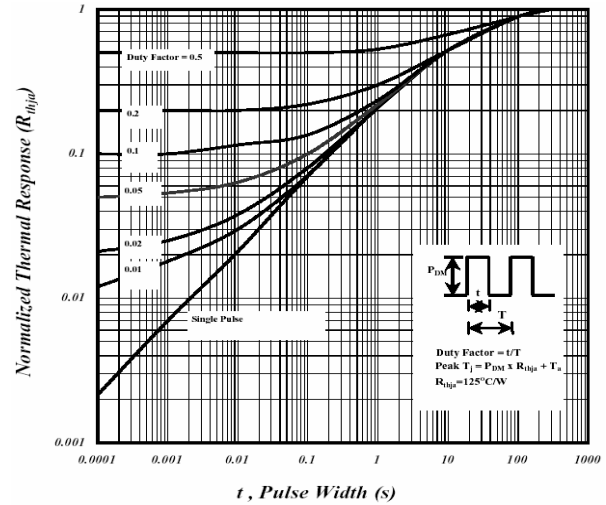

Fig 8. Effective Transient Thermal Impedance

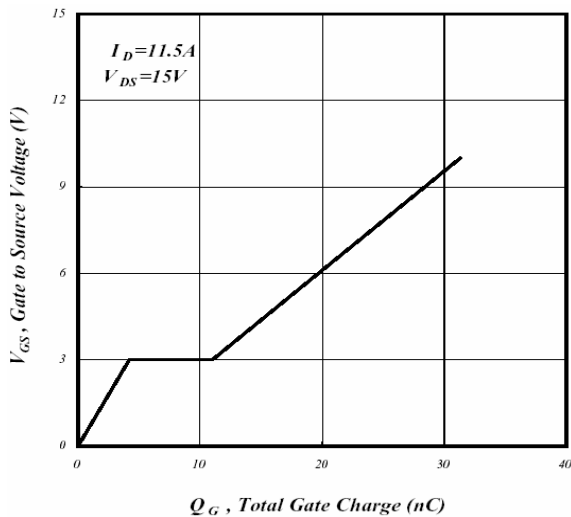

Fig 9. Gate Charge Characteristics

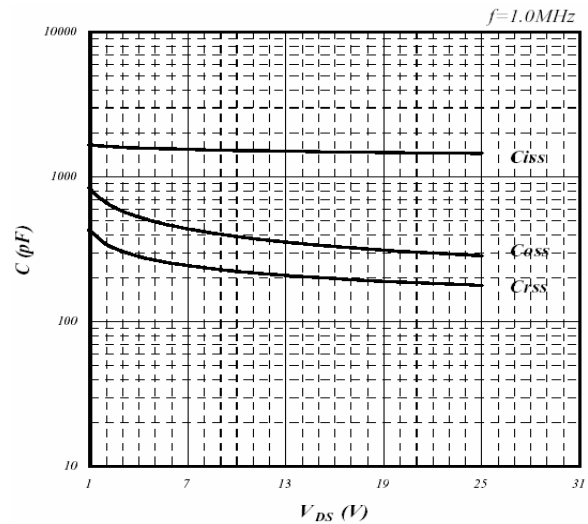

Fig 10. Typical Capacitance Characteristics

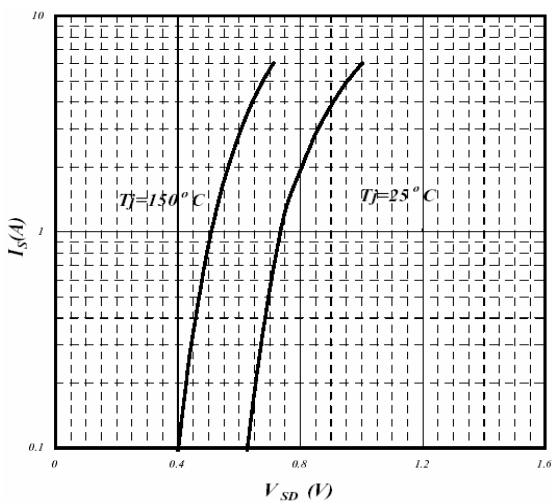

Fig 11. Forward Characteristics of Reverse Diode

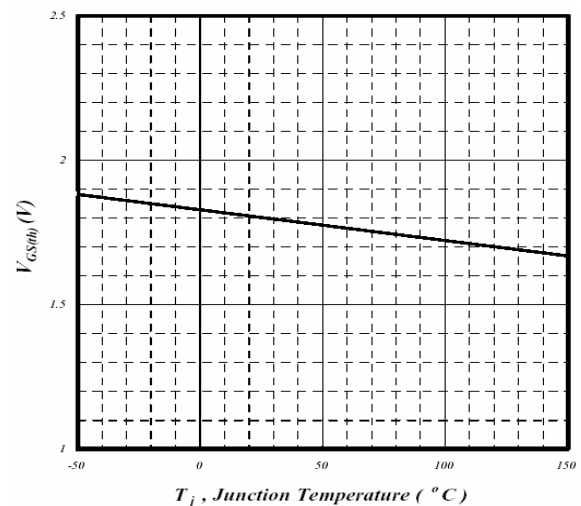

Fig 12. Gate Threshold Voltage v.s. Junction Temperature

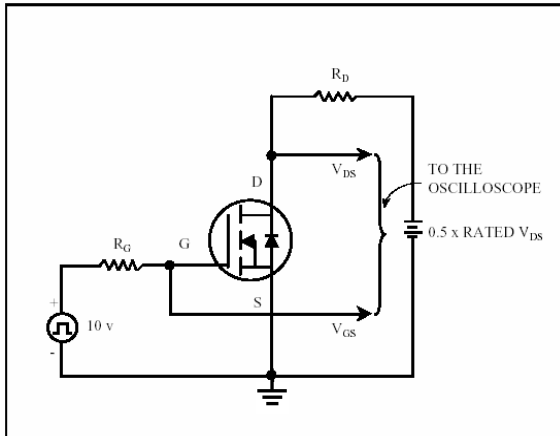

Fig 13. Switching Time Circuit

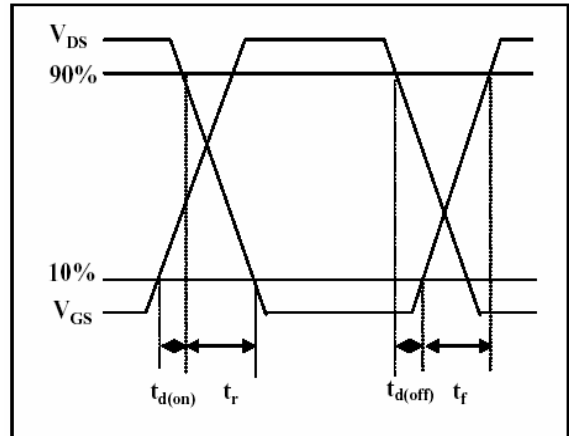

Fig 14. Switching Time Waveform

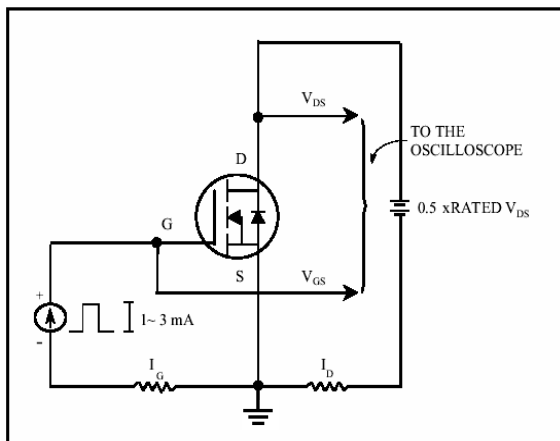

Fig 15. Gate Charge Circuit

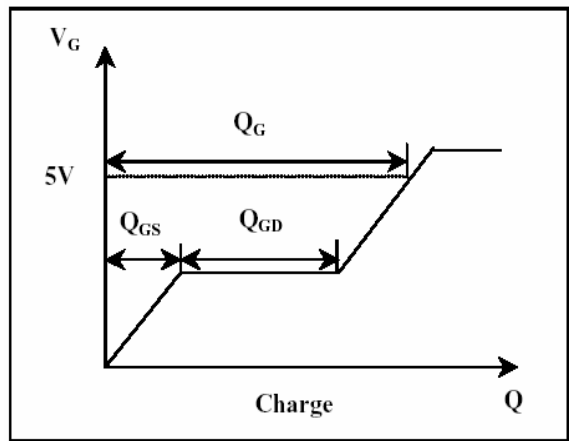
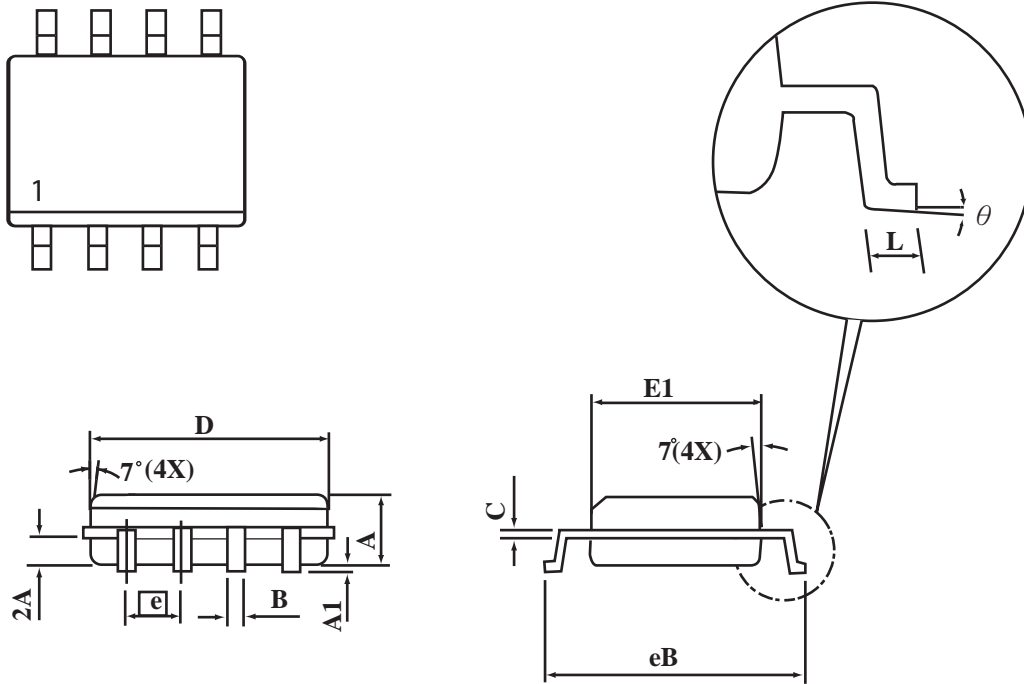

Fig 16. Gate Charge Waveform

SO-8 Package Outline Dimensions

Unit:mm



SYMBOLS	MILLIMETERS	
	MIN	MAX
A	1.35	1.75
A1	0.10	0.20
B	0.35	0.45
C	0.18	0.23
D	4.69	4.98
E1	3.56	4.06
eB	5.70	6.30
e	1.27 BSC	
L	0.60	0.80
θ	0°	8°