



RF Power Field Effect Transistor

N-Channel Enhancement-Mode Lateral MOSFET

Designed primarily for pulsed wideband applications with frequencies up to 235 MHz. Device is unmatched and is suitable for use in industrial, medical and scientific applications.

- Typical Pulsed Performance at 225 MHz: $V_{DD} = 50$ Volts, $I_{DQ} = 150$ mA, $P_{out} = 1000$ Watts Peak (200 W Avg.), Pulse Width = 100 μ sec, Duty Cycle = 20%
 Power Gain — 24 dB
 Drain Efficiency — 67.5%
- Capable of Handling 10:1 VSWR, @ 50 Vdc, 225 MHz, 1000 Watts Peak Power

Features

- Characterized with Series Equivalent Large-Signal Impedance Parameters
- CW Operation Capability with Adequate Cooling
- Qualified Up to a Maximum of 50 V_{DD} Operation
- Integrated ESD Protection
- Designed for Push-Pull Operation
- Greater Negative Gate-Source Voltage Range for Improved Class C Operation
- RoHS Compliant
- In Tape and Reel. R6 Suffix = 150 Units per 56 mm, 13 inch Reel.

MRF6VP21KHR6

**10-235 MHz, 1000 W, 50 V
 LATERAL N-CHANNEL
 BROADBAND
 RF POWER MOSFET**

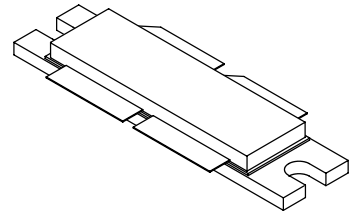

**CASE 375D-05, STYLE 1
 NI-1230
 PART IS PUSH-PULL**

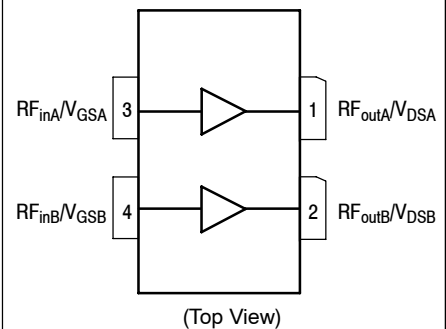

Figure 1. Pin Connections

Table 1. Maximum Ratings

Rating	Symbol	Value	Unit
Drain-Source Voltage	V_{DSS}	-0.5, +110	Vdc
Gate-Source Voltage	V_{GS}	-6, +10	Vdc
Storage Temperature Range	T_{stg}	-65 to +150	$^{\circ}$ C
Case Operating Temperature	T_C	150	$^{\circ}$ C
Operating Junction Temperature (1,2)	T_J	225	$^{\circ}$ C

Table 2. Thermal Characteristics

Characteristic	Symbol	Value (2,3)	Unit
Thermal Resistance, Junction to Case Case Temperature 80 $^{\circ}$ C, 1000 W Pulsed, 100 μ sec Pulse Width, 20% Duty Cycle	$Z_{\theta JC}$	0.03	$^{\circ}$ C/W

1. Continuous use at maximum temperature will affect MTTF.
2. MTTF calculator available at <http://www.freescale.com/rf>. Select Software & Tools/Development Tools/Calculators to access MTTF calculators by product.
3. Refer to AN1955, *Thermal Measurement Methodology of RF Power Amplifiers*. Go to <http://www.freescale.com/rf>. Select Documentation/Application Notes - AN1955.

Table 3. ESD Protection Characteristics

Test Methodology	Class
Human Body Model (per JESD22-A114)	2 (Minimum)
Machine Model (per EIA/JESD22-A115)	A (Minimum)
Charge Device Model (per JESD22-C101)	IV (Minimum)

Table 4. Electrical Characteristics ($T_A = 25^\circ\text{C}$ unless otherwise noted)

Characteristic	Symbol	Min	Typ	Max	Unit
----------------	--------	-----	-----	-----	------

Off Characteristics ⁽¹⁾

Gate-Source Leakage Current ($V_{GS} = 5\text{ Vdc}$, $V_{DS} = 0\text{ Vdc}$)	I_{GSS}	—	—	20	μAdc
Drain-Source Breakdown Voltage ($I_D = 300\text{ mA}$, $V_{GS} = 0\text{ Vdc}$)	$V_{(BR)DSS}$	110	—	—	Vdc
Zero Gate Voltage Drain Leakage Current ($V_{DS} = 50\text{ Vdc}$, $V_{GS} = 0\text{ Vdc}$)	I_{DSS}	—	—	100	μAdc
Zero Gate Voltage Drain Leakage Current ($V_{DS} = 100\text{ Vdc}$, $V_{GS} = 0\text{ Vdc}$)	I_{DSS}	—	—	5	mA

On Characteristics

Gate Threshold Voltage ⁽¹⁾ ($V_{DS} = 10\text{ Vdc}$, $I_D = 1600\ \mu\text{Adc}$)	$V_{GS(th)}$	1	1.68	3	Vdc
Gate Quiescent Voltage ⁽²⁾ ($V_{DD} = 50\text{ Vdc}$, $I_D = 150\text{ mA}$, Measured in Functional Test)	$V_{GS(Q)}$	1.5	2.2	3.5	Vdc
Drain-Source On-Voltage ⁽¹⁾ ($V_{GS} = 10\text{ Vdc}$, $I_D = 4\text{ Adc}$)	$V_{DS(on)}$	—	0.28	—	Vdc

Dynamic Characteristics ⁽¹⁾

Reverse Transfer Capacitance ($V_{DS} = 50\text{ Vdc} \pm 30\text{ mV(rms)ac}$ @ 1 MHz, $V_{GS} = 0\text{ Vdc}$)	C_{rss}	—	3.3	—	pF
Output Capacitance ($V_{DS} = 50\text{ Vdc} \pm 30\text{ mV(rms)ac}$ @ 1 MHz, $V_{GS} = 0\text{ Vdc}$)	C_{oss}	—	147	—	pF
Input Capacitance ($V_{DS} = 50\text{ Vdc}$, $V_{GS} = 0\text{ Vdc} \pm 30\text{ mV(rms)ac}$ @ 1 MHz)	C_{iss}	—	506	—	pF

Functional Tests ⁽²⁾ (In Freescale Test Fixture, 50 ohm system) $V_{DD} = 50\text{ Vdc}$, $I_{DQ} = 150\text{ mA}$, $P_{out} = 1000\text{ W Peak}$ (200 W Avg.), $f = 225\text{ MHz}$, 100 μsec Pulse Width, 20% Duty Cycle

Power Gain	G_{ps}	22	24	26	dB
Drain Efficiency	η_D	65	67.5	—	%
Input Return Loss	IRL	—	-15	-9	dB

1. Each side of device measured separately.

2. Measurement made with device in push-pull configuration.

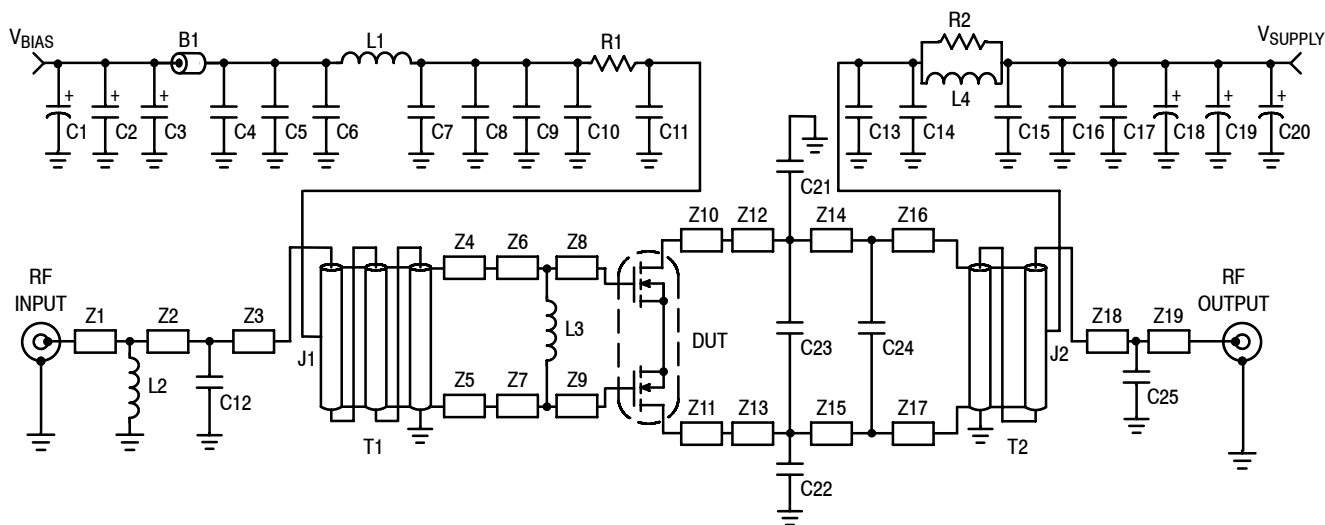

Z1	0.100" x 0.082" Microstrip	Z12, Z13	0.599" x 0.253" Microstrip
Z2*	1.557" x 0.082" Microstrip	Z14, Z15	0.110" x 0.253" Microstrip
Z3*	0.055" x 0.082" Microstrip	Z16*, Z17*	0.055" x 0.253" Microstrip
Z4, Z5	0.133" x 0.193" Microstrip	Z18	0.069" x 0.082" Microstrip
Z6, Z7	0.143" x 0.518" Microstrip	Z19	1.050" x 0.082" Microstrip
Z8, Z9	0.357" x 0.518" Microstrip	PCB	Arlon CuClad 250GX-0300-55-22, 0.030", $\epsilon_r = 2.55$
Z10, Z11	0.200" x 0.518" Microstrip		

*Line length includes microstrip bends.

Figure 2. MRF6VP21KHR6 Test Circuit Schematic

Table 5. MRF6VP21KHR6 Test Circuit Component Designations and Values

Part	Description	Part Number	Manufacturer
B1	95 Ω , 100 MHz Long Ferrite Bead	2743021447	Fair-Rite
C1	47 μ F, 50 V Electrolytic Capacitor	476KXM050M	Illinois Cap
C2	22 μ F, 35 V Tantalum Capacitor	T491X226K035AT	Kemet
C3	10 μ F, 35 V Tantalum Capacitor	T491D106K035AT	Kemet
C4, C9, C17	10K pF Chip Capacitors	ATC200B103KT50XT	ATC
C5, C16	20K pF Chip Capacitors	ATC200B203KT50XT	ATC
C6, C15	0.1 μ F, 50 V Chip Capacitors	CDR33BX104AKYS	Kemet
C7	2.2 μ F, 50 V Chip Capacitor	C1825C225J5RAC	Kemet
C8	0.22 μ F, 100 V Chip Capacitor	C1825C223K1GAC	Kemet
C10, C11, C13, C14	1000 pF Chip Capacitors	ATC100B102JT50XT	ATC
C12, C21, C22	27 pF Chip Capacitors	ATC100B270JT500XT	ATC
C18, C19, C20	470 μ F, 63 V Electrolytic Capacitors	EKME630ELL471MK25S	Multicomp
C23, C24	68 pF Chip Capacitors	ATC100B680JT500XT	ATC
C25	4.7 pF Chip Capacitor	ATC100B4R7JT500XT	ATC
J1, J2	Jumpers from PCB to T1 and T2	Copper Foil	
L1	82 nH Inductor	1812SMS-82NJC	CoilCraft
L2	8 nH Inductor	A03TKLC	CoilCraft
L3	1 Turn Inductor, Red Coil	GA3092-AL	CoilCraft
L4*	10 Turn, #18 AWG Inductor, Hand Wound	Copper Wire	
R1	1 K Ω , 1/4 W Axial Leaded Resistor	CMF601000R0FKEK	Vishay
R2	20 Ω , 3 W Chip Resistor	CPF320R000FKE14	Vishay
T1	Balun	TUI-9	Comm Concepts
T2	Balun	TUO-4	Comm Concepts

*L4 is wrapped around R2.

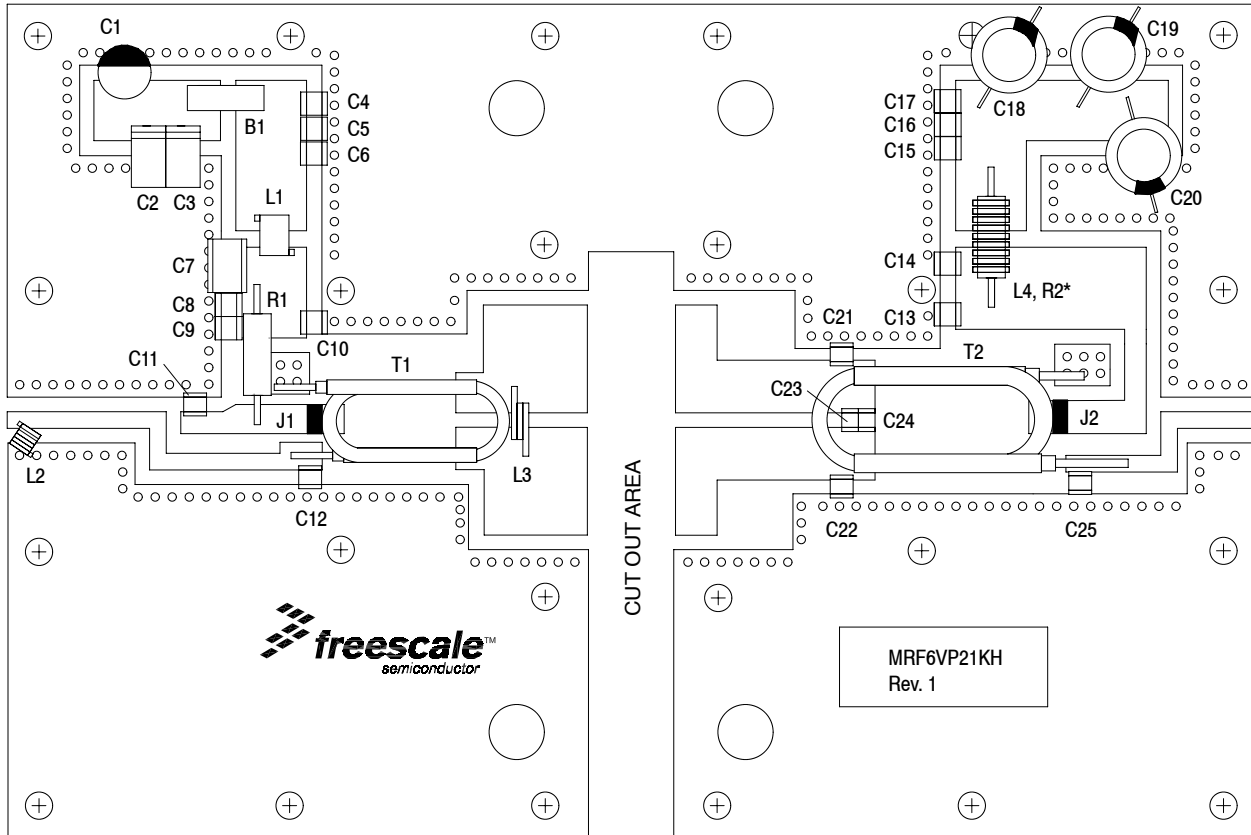

* L4 is wrapped around R2.

Figure 3. MRF6VP21KHR6 Test Circuit Component Layout

TYPICAL CHARACTERISTICS

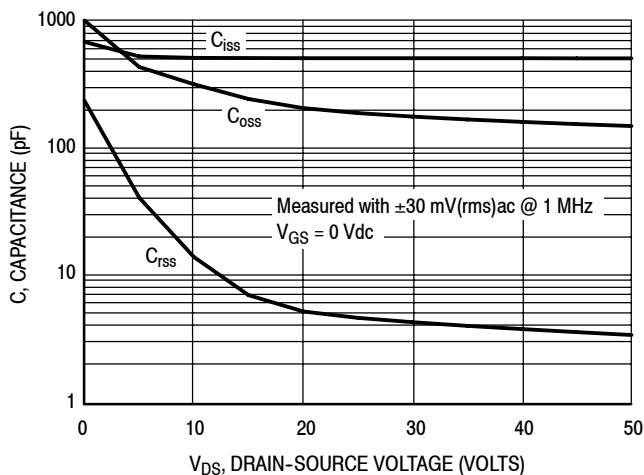

Note: Each side of device measured separately.

Figure 4. Capacitance versus Drain-Source Voltage

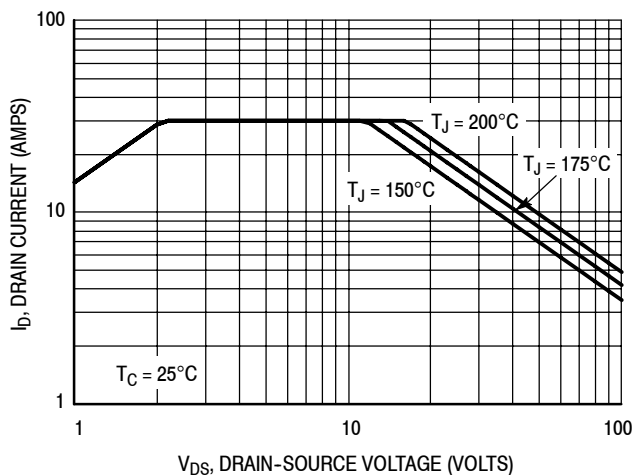

Note: Each side of device measured separately.

Figure 5. DC Safe Operating Area

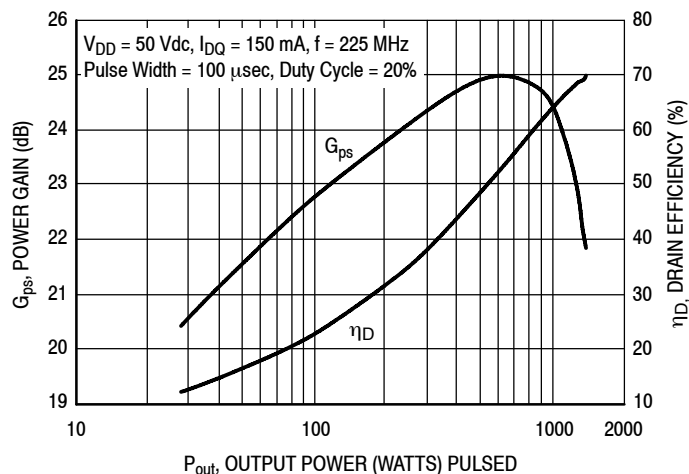

Figure 6. Pulsed Power Gain and Drain Efficiency versus Output Power

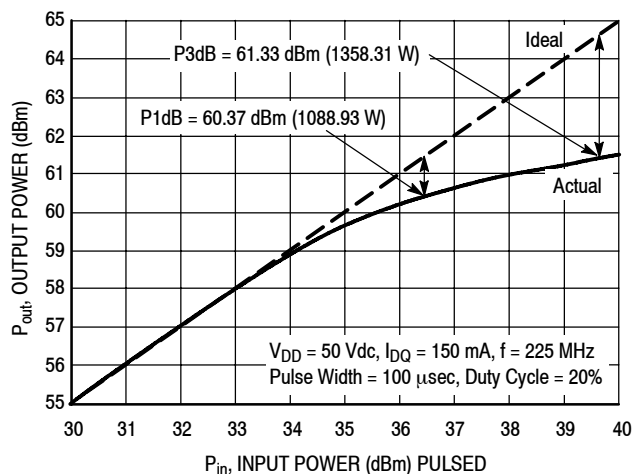

Figure 7. Pulsed Output Power versus Input Power

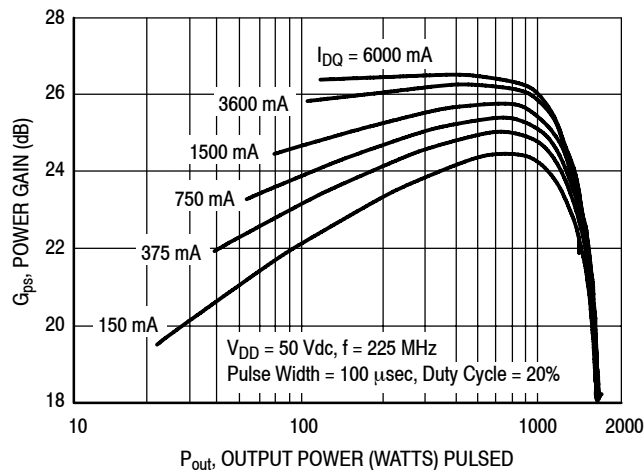

Figure 8. Pulsed Power Gain versus Output Power

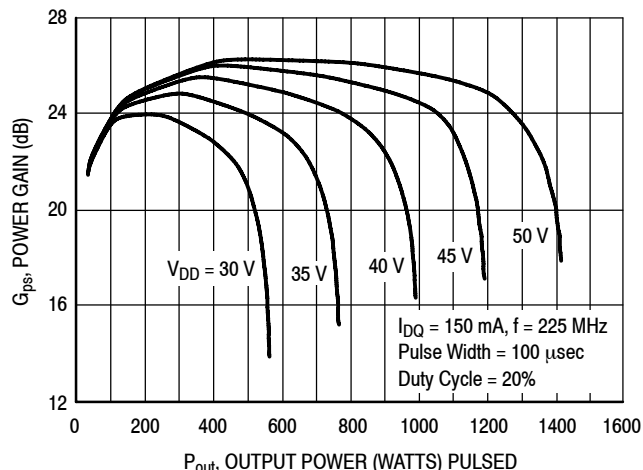

Figure 9. Pulsed Power Gain versus Output Power

TYPICAL CHARACTERISTICS

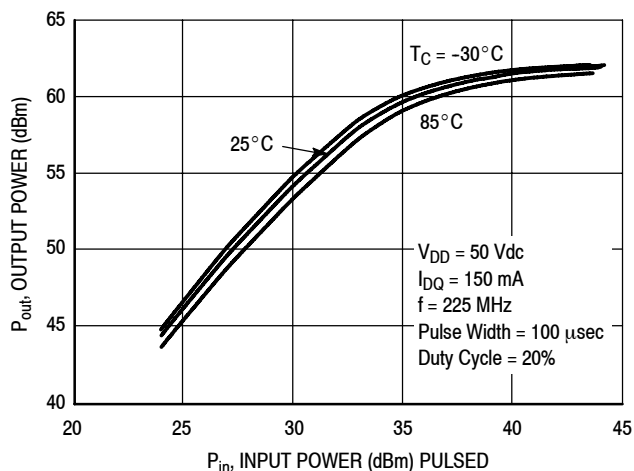

Figure 10. Pulsed Output Power versus Input Power

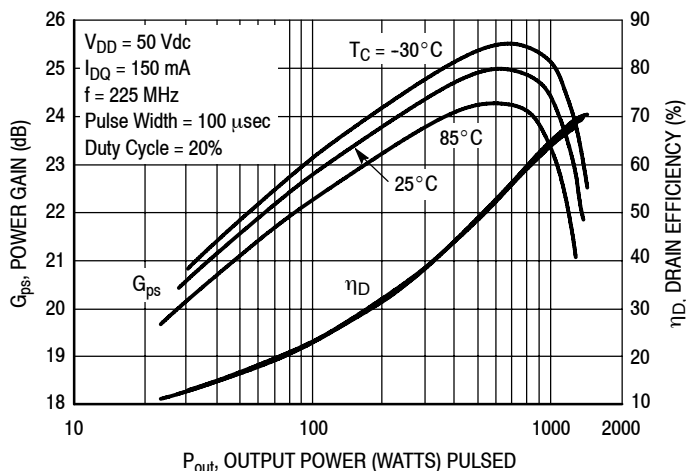

Figure 11. Pulsed Power Gain and Drain Efficiency versus Output Power

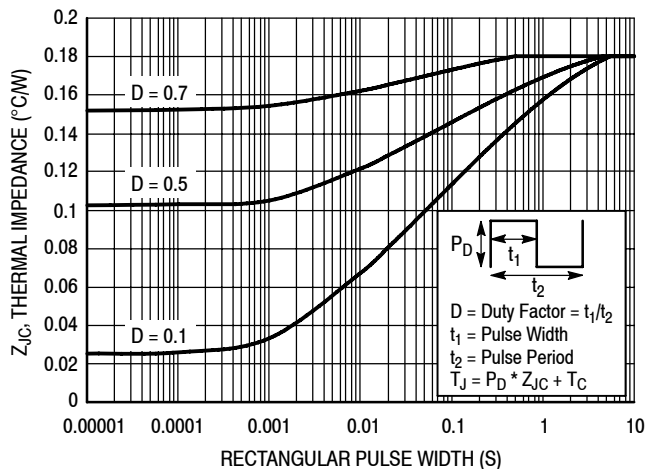
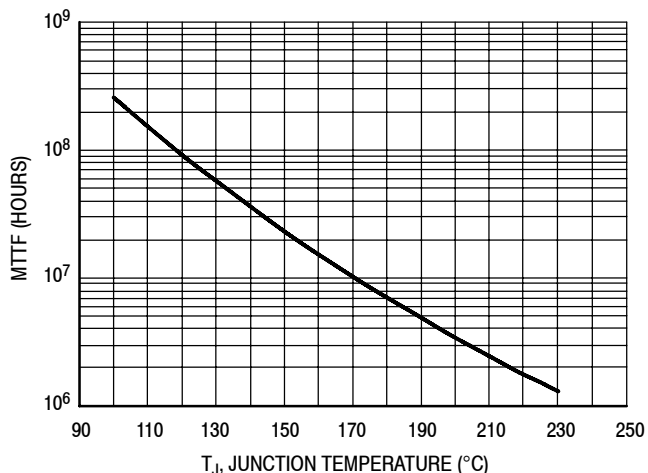

Figure 12. Maximum Transient Thermal Impedance



This above graph displays calculated MTTF in hours when the device is operated at $V_{DD} = 50 \text{ Vdc}$, $P_{out} = 1000 \text{ W Peak}$, Pulse Width = $100 \mu\text{sec}$, Duty Cycle = 20%, and $\eta_D = 67.5\%$.

MTTF calculator available at <http://www.freescale.com/rf>. Select Software & Tools/Development Tools/Calculators to access MTTF calculators by product.

Figure 13. MTTF versus Junction Temperature

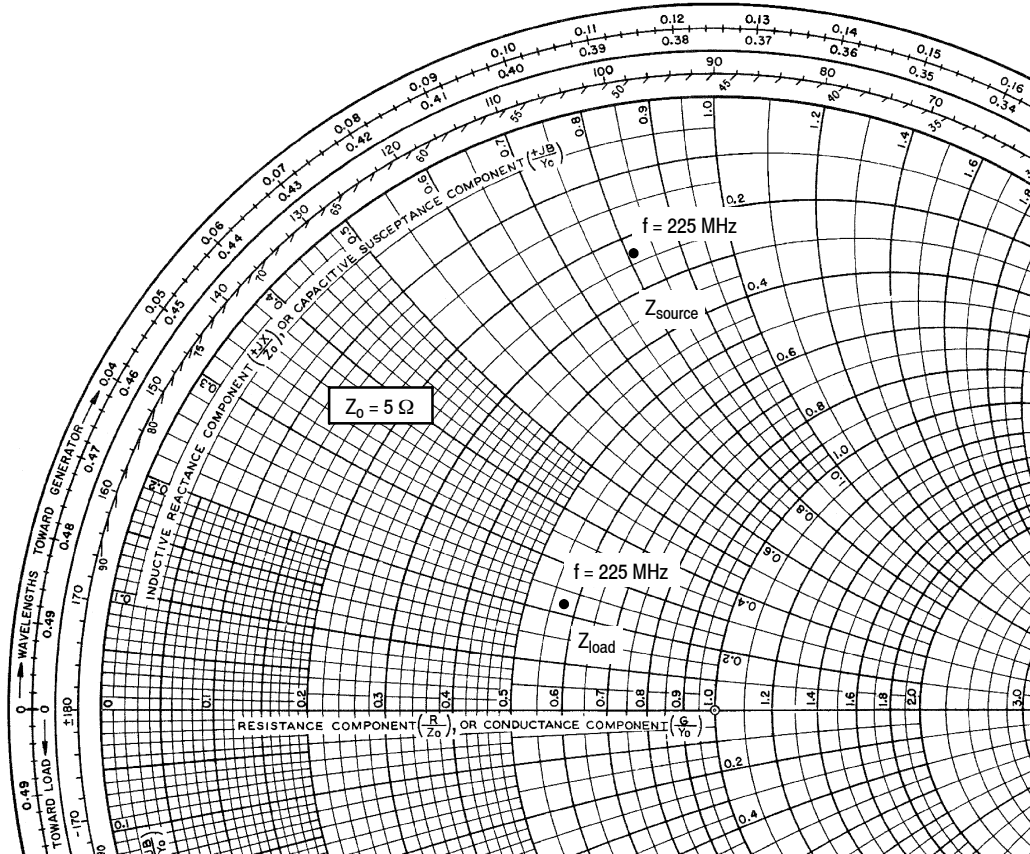

$V_{DD} = 50 \text{ Vdc}$, $I_{DQ} = 150 \text{ mA}$, $P_{out} = 1000 \text{ W Peak}$

f MHz	Z_{source} Ω	Z_{load} Ω
225	$1.16 + j4.06$	$2.86 + j1.10$

Z_{source} = Test circuit impedance as measured from gate to gate, balanced configuration.

Z_{load} = Test circuit impedance as measured from drain to drain, balanced configuration.

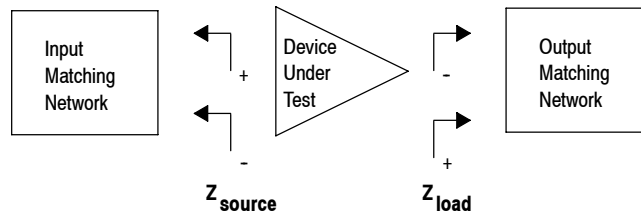
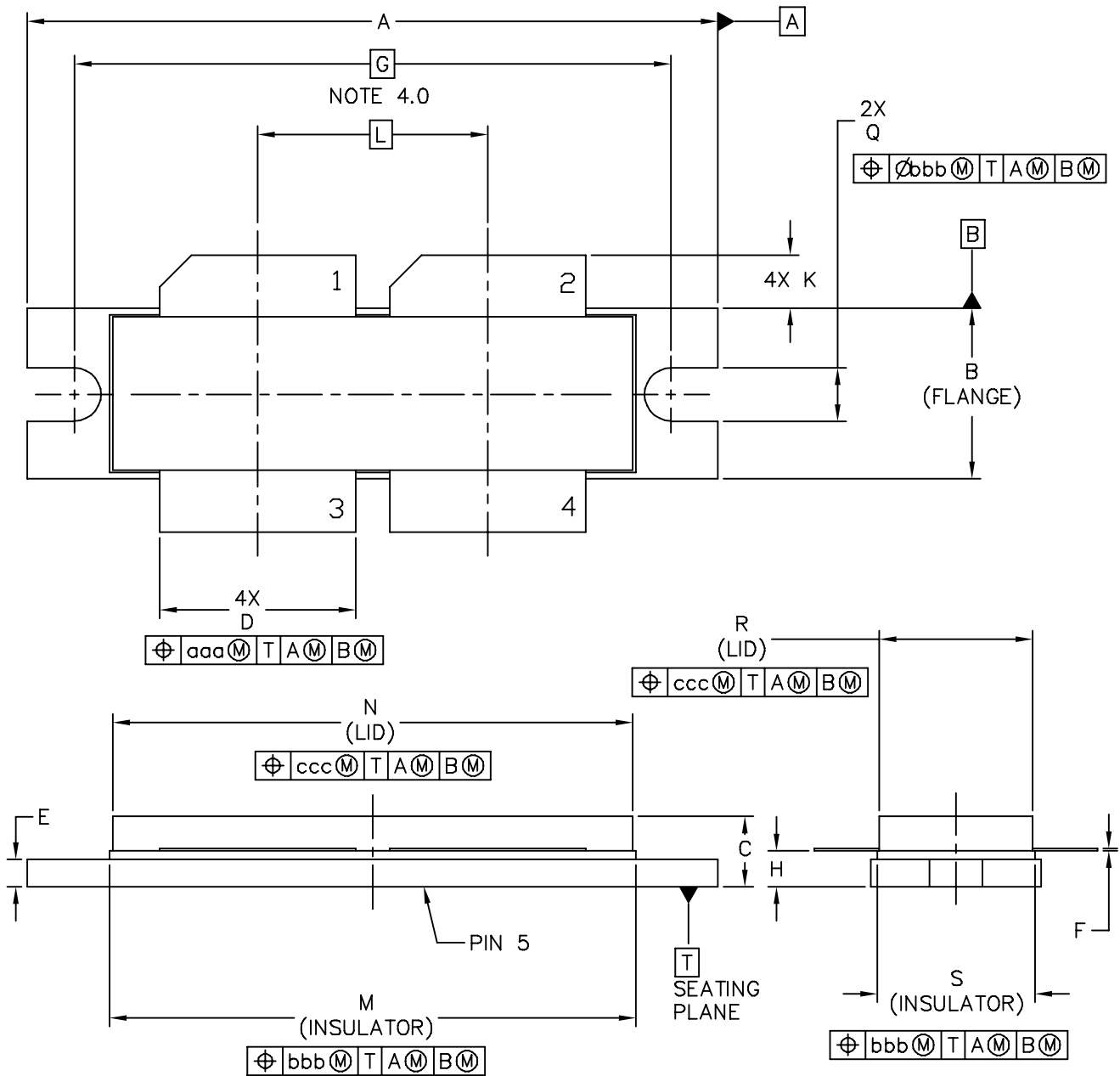

Figure 14. Series Equivalent Source and Load Impedance

PACKAGE DIMENSIONS



© FREESCALE SEMICONDUCTOR, INC. ALL RIGHTS RESERVED.	MECHANICAL OUTLINE	PRINT VERSION NOT TO SCALE
TITLE: <div style="text-align: center; font-size: 1.2em;">NI-1230</div>	DOCUMENT NO: 98ASB16977C CASE NUMBER: 375D-05 STANDARD: NON-JEDEC	REV: E 31 MAR 2005

NOTES:

- 1.0 INTERPRET DIMENSIONS AND TOLERANCES PER ASME Y14.5M-1994.
- 2.0 CONTROLLING DIMENSION: INCH
- 3.0 DIMENSION H IS MEASURED .030 (0.762) AWAY FROM PACKAGE BODY.
- 4.0 RECOMMENDED BOLT CENTER DIMENSION OF 1.52 (38.61) BASED ON M3 SCREW.

STYLE 1:

- PIN 1 - DRAIN
- 2 - DRAIN
- 3 - GATE
- 4 - GATE
- 5 - SOURCE

DIM	INCH		MILLIMETER		DIM	INCH		MILLIMETER	
	MIN	MAX	MIN	MAX		MIN	MAX	MIN	MAX
A	1.615	1.625	41.02	41.28	N	1.218	1.242	30.94	31.55
B	.395	.405	10.03	10.29	Q	.120	.130	3.05	3.3
C	.150	.200	3.81	5.08	R	.355	.365	9.01	9.27
D	.455	.465	11.56	11.81	S	.365	.375	9.27	9.53
E	.062	.066	1.57	1.68					
F	.004	.007	0.1	0.18					
G	1.400 BSC		35.56 BSC		aaa	.013		0.33	
H	.082	.090	2.08	2.29	bbb	.010		0.25	
K	.117	.137	2.97	3.48	ccc	.020		0.51	
L	.540 BSC		13.72 BSC						
M	1.219	1.241	30.96	31.52					
© FREESCALE SEMICONDUCTOR, INC. ALL RIGHTS RESERVED.			MECHANICAL OUTLINE			PRINT VERSION NOT TO SCALE			
TITLE: NI-1230					DOCUMENT NO: 98ASB16977C			REV: E	
					CASE NUMBER: 375D-05			31 MAR 2005	
					STANDARD: NON-JEDEC				

PRODUCT DOCUMENTATION AND SOFTWARE

Refer to the following documents to aid your design process.

Application Notes

- AN1955: Thermal Measurement Methodology of RF Power Amplifiers

Engineering Bulletins

- EB212: Using Data Sheet Impedances for RF LDMOS Devices

Software

- Electromigration MTTF Calculator
- RF High Power Model

For Software, do a Part Number search at <http://www.freescale.com>, and select the “Part Number” link. Go to the Software & Tools tab on the part’s Product Summary page to download the respective tool.

REVISION HISTORY

The following table summarizes revisions to this document.

Revision	Date	Description
0	Jan. 2008	<ul style="list-style-type: none">• Initial Release of Data Sheet
1	Apr. 2008	<ul style="list-style-type: none">• Corrected description and part number for the R1 resistor and updated R2 resistor to latest RoHS compliant part number in Table 5, Test Circuit Component Designations and Values, and updated the footnote to read “L4” versus “L3”, p. 3.• Added Fig. 12, Maximum Transient Thermal Impedance, p. 6
2	Sept. 2008	<ul style="list-style-type: none">• Added Note to Fig. 4, Capacitance versus Drain–Source Voltage, to denote that each side of device is measured separately, p. 5• Updated Fig. 5, DC Safe Operating Area, to clarify that measurement is on a per–side basis, p. 5• Corrected Fig. 13, MTTF versus Junction Temperature, to reflect the correct die size and increased the MTTF factor accordingly, p. 6
3	Dec. 2008	<ul style="list-style-type: none">• Fig. 14, Series Equivalent Source and Load Impedance, corrected Z_{source} copy to read “Test circuit impedance as measured from gate to gate, balanced configuration” and Z_{load} copy to read “Test circuit impedance as measured from drain to drain, balanced configuration”; replaced impedance diagram to show push–pull test conditions, p. 7
4	Apr. 2010	<ul style="list-style-type: none">• Operating Junction Temperature increased from 200°C to 225°C in Maximum Ratings table and related “Continuous use at maximum temperature will affect MTTF” footnote added, p. 1• Reporting of pulsed thermal data now shown using the $Z_{\theta JC}$ symbol, p. 1• Added Electromigration MTTF Calculator and RF High Power Model availability to Product Software, p. 10

How to Reach Us:

Home Page:

www.freescale.com

Web Support:

<http://www.freescale.com/support>

USA/Europe or Locations Not Listed:

Freescale Semiconductor, Inc.
Technical Information Center, EL516
2100 East Elliot Road
Tempe, Arizona 85284
1-800-521-6274 or +1-480-768-2130
www.freescale.com/support

Europe, Middle East, and Africa:

Freescale Halbleiter Deutschland GmbH
Technical Information Center
Schatzbogen 7
81829 Muenchen, Germany
+44 1296 380 456 (English)
+46 8 52200080 (English)
+49 89 92103 559 (German)
+33 1 69 35 48 48 (French)
www.freescale.com/support

Japan:

Freescale Semiconductor Japan Ltd.
Headquarters
ARCO Tower 15F
1-8-1, Shimo-Meguro, Meguro-ku,
Tokyo 153-0064
Japan
0120 191014 or +81 3 5437 9125
support.japan@freescale.com

Asia/Pacific:

Freescale Semiconductor China Ltd.
Exchange Building 23F
No. 118 Jianguo Road
Chaoyang District
Beijing 100022
China
+86 10 5879 8000
support.asia@freescale.com

For Literature Requests Only:

Freescale Semiconductor Literature Distribution Center
1-800-441-2447 or +1-303-675-2140
Fax: +1-303-675-2150
LDCForFreescaleSemiconductor@hibbertgroup.com

Information in this document is provided solely to enable system and software implementers to use Freescale Semiconductor products. There are no express or implied copyright licenses granted hereunder to design or fabricate any integrated circuits or integrated circuits based on the information in this document.

Freescale Semiconductor reserves the right to make changes without further notice to any products herein. Freescale Semiconductor makes no warranty, representation or guarantee regarding the suitability of its products for any particular purpose, nor does Freescale Semiconductor assume any liability arising out of the application or use of any product or circuit, and specifically disclaims any and all liability, including without limitation consequential or incidental damages. "Typical" parameters that may be provided in Freescale Semiconductor data sheets and/or specifications can and do vary in different applications and actual performance may vary over time. All operating parameters, including "Typicals", must be validated for each customer application by customer's technical experts. Freescale Semiconductor does not convey any license under its patent rights nor the rights of others. Freescale Semiconductor products are not designed, intended, or authorized for use as components in systems intended for surgical implant into the body, or other applications intended to support or sustain life, or for any other application in which the failure of the Freescale Semiconductor product could create a situation where personal injury or death may occur. Should Buyer purchase or use Freescale Semiconductor products for any such unintended or unauthorized application, Buyer shall indemnify and hold Freescale Semiconductor and its officers, employees, subsidiaries, affiliates, and distributors harmless against all claims, costs, damages, and expenses, and reasonable attorney fees arising out of, directly or indirectly, any claim of personal injury or death associated with such unintended or unauthorized use, even if such claim alleges that Freescale Semiconductor was negligent regarding the design or manufacture of the part.

Freescale™ and the Freescale logo are trademarks of Freescale Semiconductor, Inc. All other product or service names are the property of their respective owners.

© Freescale Semiconductor, Inc. 2008, 2010. All rights reserved.