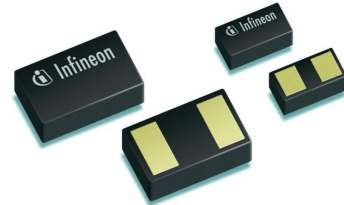
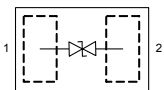

Bi-directional Ultra Low Capacitance TVS Diode

- ESD / transient protection of RF signal lines according to:
IEC61000-4-2 (ESD): $\pm 20\text{kV}$ (contact)
IEC61000-4-4 (EFT): 40 A (5 / 50 ns)
IEC61000-4-5 (Surge): 3 A (8 / 20 μs)
- Extremely small form factor down to 0.62 x 0.32 x 0.31 mm³
- Very low dynamic resistance
- Max. working voltage: $\pm 5.3\text{ V}$
- Extremely low capacitance: 0.2 pF typ.
- Very low reverse current < 1 nA typ.
- Very low series inductance down to 0.2 nH typ.
- Pb-free (RoHS compliant) package
- Qualified according AEC Q101

Applications

- ESD protection of sensitive RF signal lines
- RF antenna protection, frontend module
- GPS, mobile TV, FM radio, RKE, UWB

ESD0P2RF-02LRH
ESD0P2RF-02LS

Type	Package	Configuration	Marking
ESD0P2RF-02LRH	TSLP-2-17	1 line, bi-directional	T
ESD0P2RF-02LS	TSSLP-2-1	1 line, bi-directional	T

Maximum Ratings at $T_A = 25^\circ\text{C}$, unless otherwise specified

Parameter	Symbol	Value	Unit
ESD contact discharge ¹), contact	V_{ESD}	20	kV
Peak pulse current ($t_p = 8 / 20 \mu\text{s}$) ²)	I_{pp}	3	A
Operating temperature range	T_{op}	-55...125	°C
Storage temperature	T_{stg}	-55...150	

¹ V_{ESD} according to IEC61000-4-2

² I_{pp} according to IEC61000-4-5

Electrical Characteristics at $T_A = 25^\circ\text{C}$, unless otherwise specified

Parameter	Symbol	Values			Unit
		min.	typ.	max.	
Characteristics -					
Reverse working voltage	V_{RWM}	-5.3	-	5.3	V
Breakdown voltage	$V_{(\text{BR})}$				
$I_{(\text{BR})} = 1 \text{ mA}$, from pin 2 to 1		7	-	-	
$I_{(\text{BR})} = 1 \text{ mA}$, from pin 1 to 2		7	-	-	
Reverse current $V_R = 5.3 \text{ V}$	I_R	-	<1	50	nA
Clamping voltage	V_{CL}				V
$I_{\text{PP}} = 1 \text{ A}$, $t_p = 8/20 \mu\text{s}$ ¹)		-	11	17	
$I_{\text{PP}} = 3 \text{ A}$, $t_p = 8/20 \mu\text{s}$ ¹)		-	15	21	
Diode capacitance	C_T				pF
$V_R = 0 \text{ V}$, $f = 1 \text{ MHz}$		-	0.23	0.4	
$V_R = 0 \text{ V}$, $f = 1 \text{ GHz}$		-	0.2	0.4	
Dynamic resistance ($t_p=30\text{ns}$)	R_D	-	1	-	Ω
Series inductance	L_S				nH
ESD0P2RF-02LS		-	0.2	-	
ESD0P2RF-02LRH		-	0.4	-	

¹ I_{pp} according to IEC61000-4-5

Clamping voltage, $V_{cl} = f(I_{pp})$

$t_p = 8 / 20 \mu s$

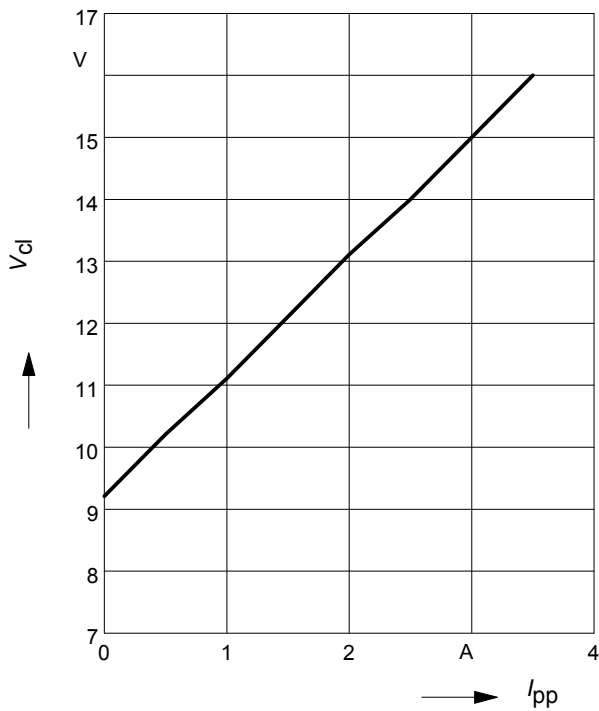

Reverse current $I_R = f(V_R)$

$T_A = \text{Parameter}$

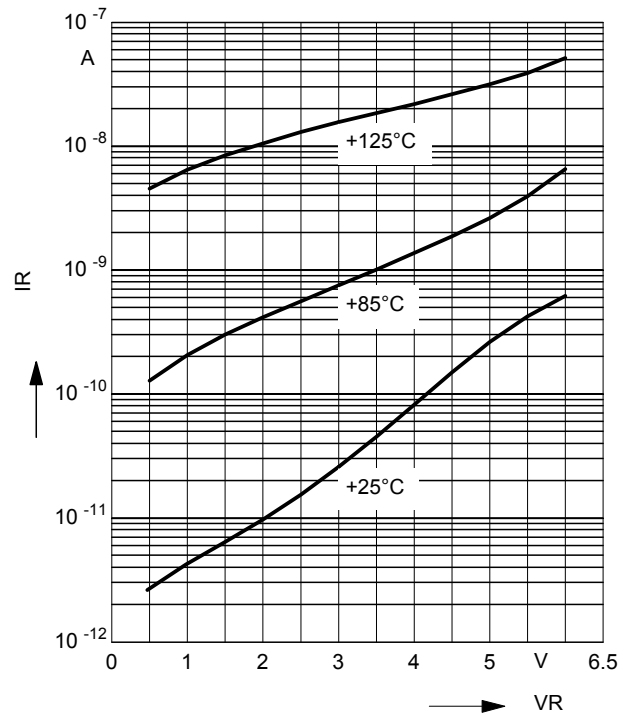

Diode capacitance $C_T = f(V_R)$

$f = 1 \text{ MHz}$

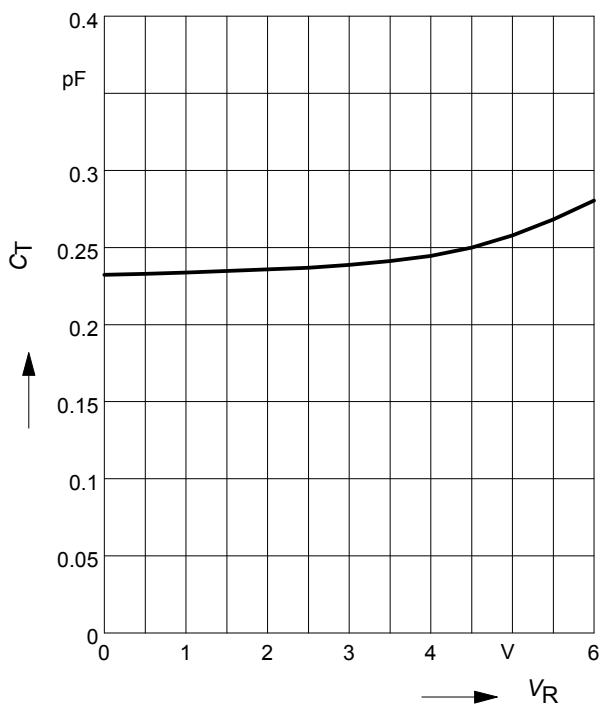

Line capacitance $C_T = f(f)$

$V_R = \text{Parameter}$

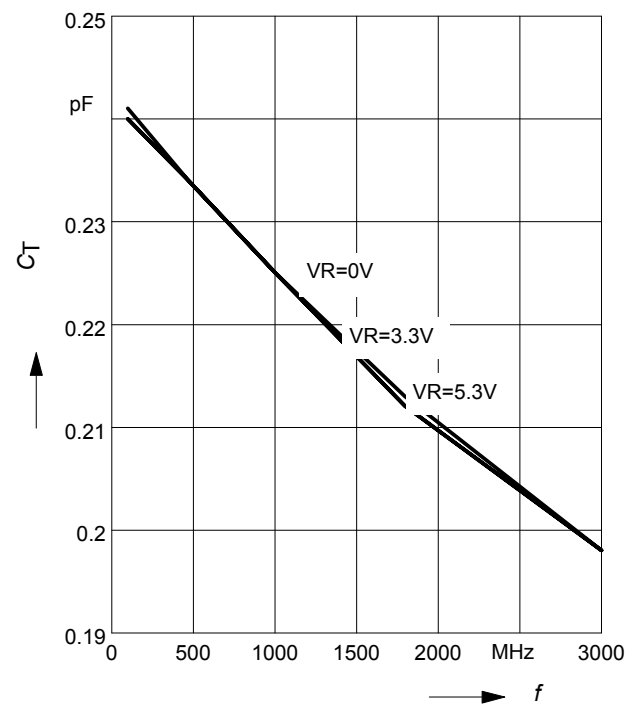

Line capacitance $C_T = f(T_A)$

$V_R =$ Parameter, $f = 1$ MHz

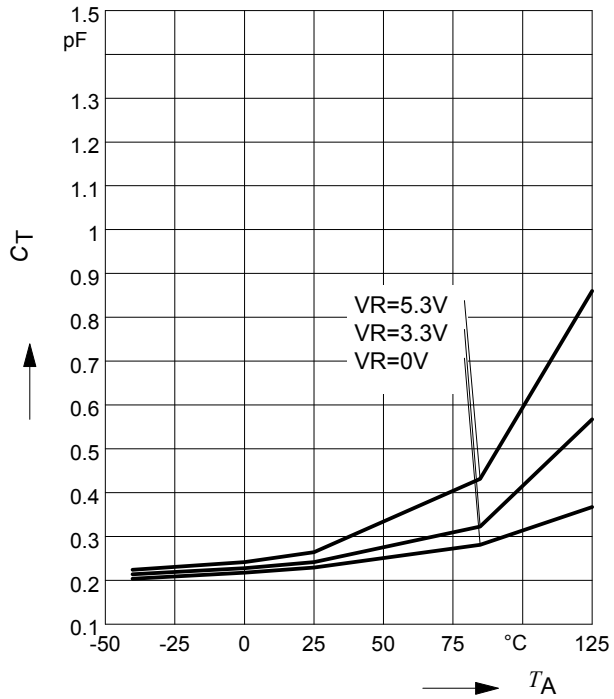

Application example ESD0P2RF...

1 line, bi-directional

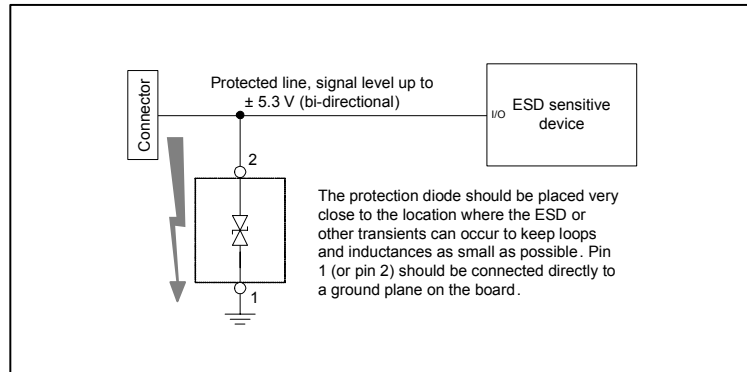

Package Outline

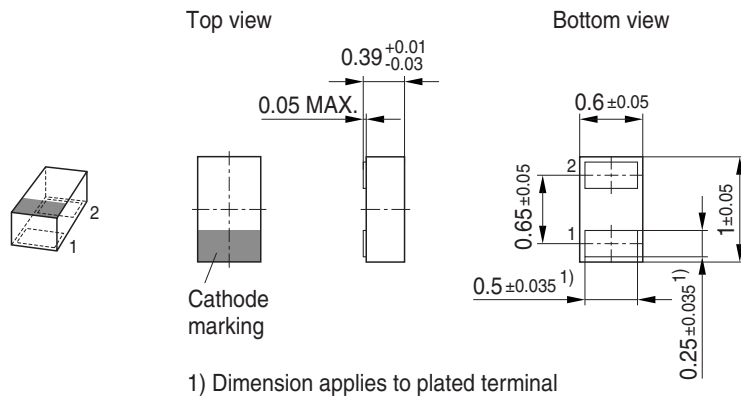

Foot Print

For board assembly information please refer to Infineon website "Packages"

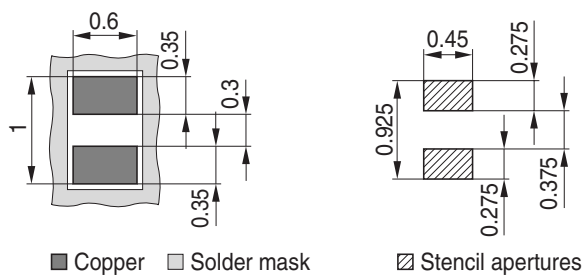

Marking Layout (Example)

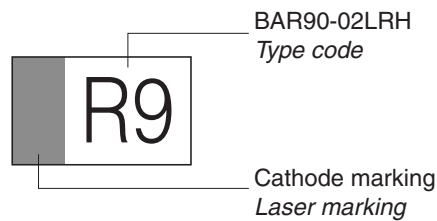

Standard Packing

Reel ø180 mm = 15.000 Pieces/Reel
 Reel ø330 mm = 50.000 Pieces/Reel (optional)

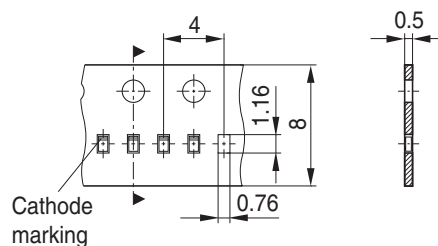

Package Outline

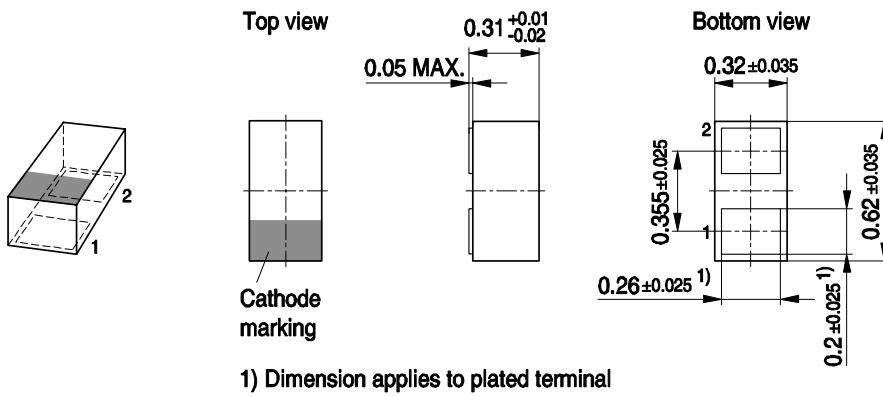

Foot Print

For board assembly information please refer to Infineon website "Packages"

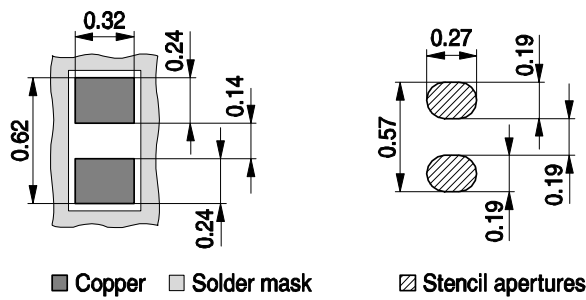

Marking Layout (Example)

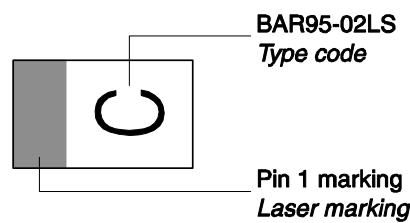

Standard Packing

Reel ø180 mm = 15.000 Pieces/Reel

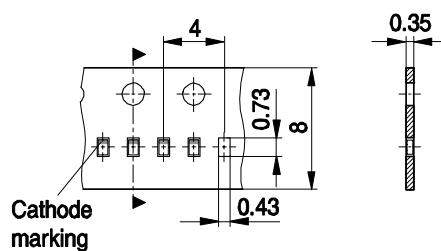

Edition 2009-11-16

**Published by
Infineon Technologies AG
81726 Munich, Germany**

**© 2009 Infineon Technologies AG
All Rights Reserved.**

Legal Disclaimer

The information given in this document shall in no event be regarded as a guarantee of conditions or characteristics. With respect to any examples or hints given herein, any typical values stated herein and/or any information regarding the application of the device, Infineon Technologies hereby disclaims any and all warranties and liabilities of any kind, including without limitation, warranties of non-infringement of intellectual property rights of any third party.

Information

For further information on technology, delivery terms and conditions and prices, please contact the nearest Infineon Technologies Office (www.infineon.com).

Warnings

Due to technical requirements, components may contain dangerous substances. For information on the types in question, please contact the nearest Infineon Technologies Office.

Infineon Technologies components may be used in life-support devices or systems only with the express written approval of Infineon Technologies, if a failure of such components can reasonably be expected to cause the failure of that life-support device or system or to affect the safety or effectiveness of that device or system. Life support devices or systems are intended to be implanted in the human body or to support and/or maintain and sustain and/or protect human life. If they fail, it is reasonable to assume that the health of the user or other persons may be endangered.