

AOD4104

N-Channel Enhancement Mode Field Effect Transistor

General Description

The AOD4104 uses advanced trench technology to provide excellent $R_{DS(ON)}$, shoot-through immunity and body diode characteristics. This device is ideally suited for use as a low side switch in CPU core power conversion.

- RoHS Compliant
- Halogen Free*

Features

$V_{DS} (V) = 25V$
 $I_D = 75A (V_{GS} = 10V)$
 $R_{DS(ON)} < 3.6m\Omega (V_{GS} = 20V)$
 $R_{DS(ON)} < 4.5m\Omega (V_{GS} = 12V)$
 $R_{DS(ON)} < 5.4m\Omega (V_{GS} = 10V)$

100% UIS Tested!
100% Rg Tested!

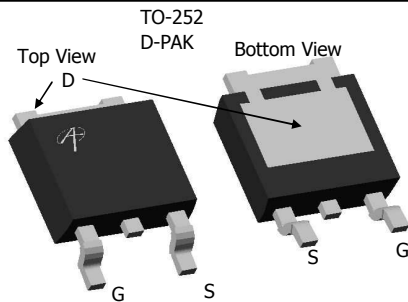

Absolute Maximum Ratings $T_A=25^\circ C$ unless otherwise noted

Parameter	Symbol	Maximum	Units
Drain-Source Voltage	V_{DS}	25	V
Gate-Source Voltage	V_{GS}	± 30	V
Continuous Drain Current ^{B,G,I}	I_D	$T_C=25^\circ C^G$	75
		$T_C=100^\circ C$	75
Pulsed Drain Current ^C	I_{DM}	200	A
Avalanche Current ^C	I_{AR}	30	A
Repetitive avalanche energy $L=0.3mH^C$	E_{AR}	135	mJ
Power Dissipation ^B	P_D	$T_C=25^\circ C$	100
		$T_C=100^\circ C$	50
Power Dissipation ^A	P_{DSM}	$T_A=25^\circ C$	2.5
		$T_A=70^\circ C$	1.6
Junction and Storage Temperature Range	T_J, T_{STG}	-55 to 175	$^\circ C$

Thermal Characteristics

Parameter	Symbol	Typ	Max	Units
Maximum Junction-to-Ambient ^A	$R_{\theta JA}$	16	20	$^\circ C/W$
Maximum Junction-to-Ambient ^A		Steady-State	40	50
Maximum Junction-to-Case ^B	$R_{\theta JC}$	1	1.5	$^\circ C/W$

Electrical Characteristics (T_J=25°C unless otherwise noted)

Symbol	Parameter	Conditions	Min	Typ	Max	Units
STATIC PARAMETERS						
BV _{DSS}	Drain-Source Breakdown Voltage	I _D =250μA, V _{GS} =0V	25			V
I _{DSS}	Zero Gate Voltage Drain Current	V _{DS} =20V, V _{GS} =0V T _J =55°C		0.005	1 5	μA
I _{GSS}	Gate-Body leakage current	V _{DS} =0V, V _{GS} = ±30V			100	nA
V _{GS(th)}	Gate Threshold Voltage	V _{DS} =V _{GS} , I _D =250μA	2	3	4	V
I _{D(ON)}	On state drain current	V _{GS} =12V, V _{DS} =5V	200			A
R _{DS(ON)}	Static Drain-Source On-Resistance	V _{GS} =20V, I _D =20A T _J =125°C		3 4.2	3.6 5	mΩ
		V _{GS} =12V, I _D =20A		3.7	4.5	
		V _{GS} =10V, I _D =20A		4.5	5.4	
g _{FS}	Forward Transconductance	V _{DS} =5V, I _D =20A		75		S
V _{SD}	Diode Forward Voltage	I _S =1A, V _{GS} =0V		0.7	1	V
I _S	Maximum Body-Diode Continuous Current				55	A
DYNAMIC PARAMETERS						
C _{iss}	Input Capacitance	V _{GS} =0V, V _{DS} =12.5V, f=1MHz		2100	2400	pF
C _{oss}	Output Capacitance		850		pF	
C _{rss}	Reverse Transfer Capacitance		400		pF	
R _g	Gate resistance	V _{GS} =0V, V _{DS} =0V, f=1MHz		0.35	1	Ω
SWITCHING PARAMETERS						
Q _g (12V)	Total Gate Charge	V _{GS} =10V, V _{DS} =12.5V, I _D =20A		40	50	nC
Q _g (10V)	Total Gate Charge		33		nC	
Q _{gs}	Gate Source Charge		11		nC	
Q _{gd}	Gate Drain Charge		14		nC	
t _{D(on)}	Turn-On DelayTime	V _{GS} =10V, V _{DS} =12.5V, R _L =0.68Ω, R _{GEN} =3Ω		12		ns
t _r	Turn-On Rise Time		19		ns	
t _{D(off)}	Turn-Off DelayTime		15		ns	
t _f	Turn-Off Fall Time		8.5		ns	
t _{rr}	Body Diode Reverse Recovery Time		I _F =20A, di/dt=100A/μs		42	
Q _{rr}	Body Diode Reverse Recovery Charge	I _F =20A, di/dt=100A/μs		34		nC

A: The value of R_{θJA} is measured with the device mounted on 1in² FR-4 board with 2oz. Copper, in a still air environment with T_A=25°C. The Power dissipation P_{DSM} is based on R_{θJA} and the maximum allowed junction temperature of 150°C. The value in any given application depends on the user's specific board design, and the maximum temperature of 175°C may be used if the PCB allows it.

B: The power dissipation P_D is based on T_{J(MAX)}=175°C, using junction-to-case thermal resistance, and is more useful in setting the upper dissipation limit for cases where additional heatsinking is used.

C: Repetitive rating, pulse width limited by junction temperature T_{J(MAX)}=175°C.

D: The R_{θJA} is the sum of the thermal impedance from junction to case R_{θJC} and case to ambient.

E: The static characteristics in Figures 1 to 6 are obtained using <300μs pulses, duty cycle 0.5% max.

F: These curves are based on the junction-to-case thermal impedance which is measured with the device mounted to a large heatsink, assuming a maximum junction temperature of T_{J(MAX)}=175°C.

G: The maximum current rating is limited by bond-wires.

H: These tests are performed with the device mounted on 1 in 2 FR-4 board with 2oz. Copper, in a still air environment with T_A=25°C. The SOA curve provides a single pulse rating.

I: The maximum current rating is limited by bond-wires.

*This device is guaranteed green after data code 8X11 (Sep 8th 2008).

Rev1:Oct 2008

THIS PRODUCT HAS BEEN DESIGNED AND QUALIFIED FOR THE CONSUMER MARKET. APPLICATIONS OR USES AS CRITICAL COMPONENTS IN LIFE SUPPORT DEVICES OR SYSTEMS ARE NOT AUTHORIZED. AOS DOES NOT ASSUME ANY LIABILITY ARISING OUT OF SUCH APPLICATIONS OR USES OF ITS PRODUCTS. AOS RESERVES THE RIGHT TO IMPROVE PRODUCT DESIGN, FUNCTIONS AND RELIABILITY WITHOUT NOTICE.

TYPICAL ELECTRICAL AND THERMAL CHARACTERISTICS

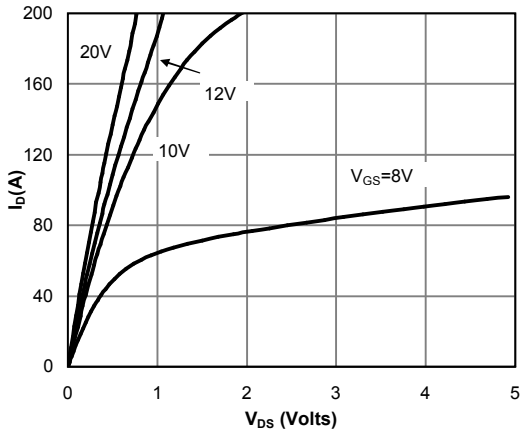

Figure 1: On-Region Characteristics

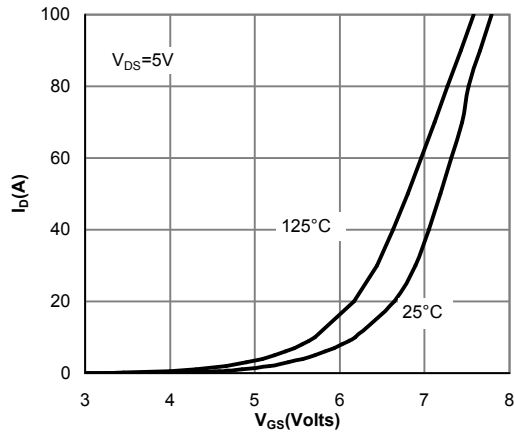

Figure 2: Transfer Characteristics

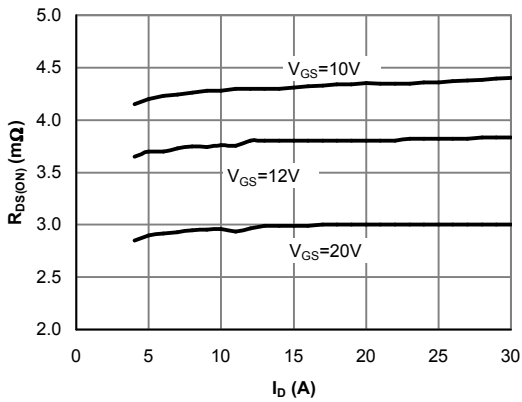

Figure 3: On-Resistance vs. Drain Current and Gate Voltage

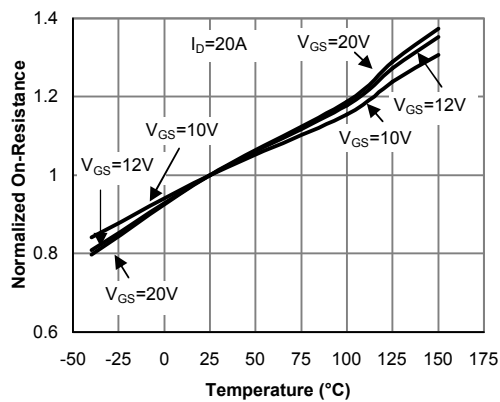

Figure 4: On-Resistance vs. Junction Temperature

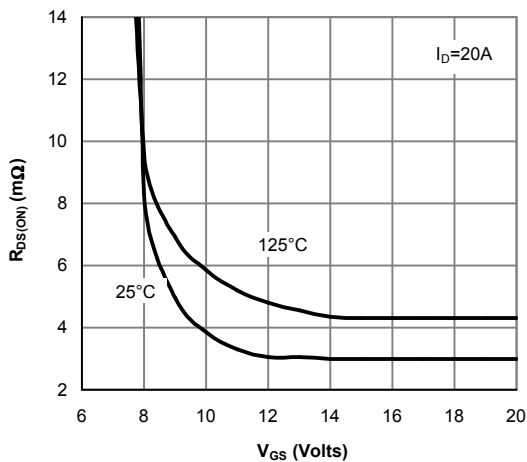

Figure 5: On-Resistance vs. Gate-Source Voltage

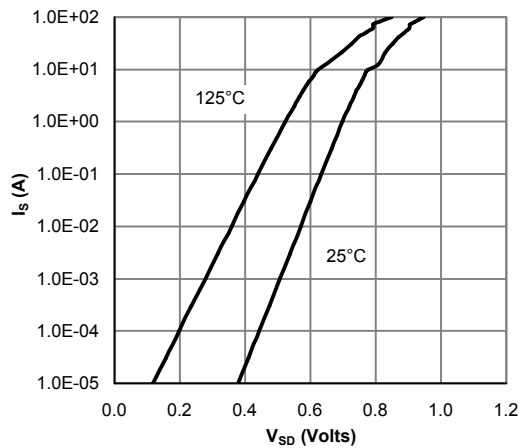

Figure 6: Body-Diode Characteristics

TYPICAL ELECTRICAL AND THERMAL CHARACTERISTICS

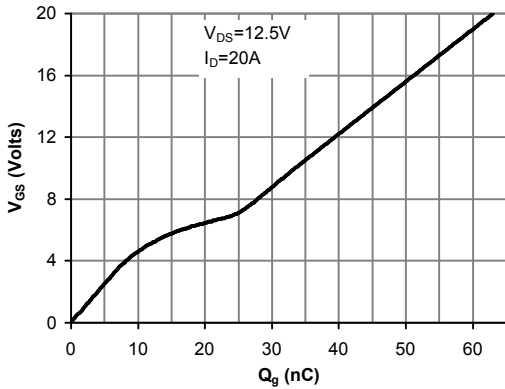

Figure 7: Gate-Charge Characteristics

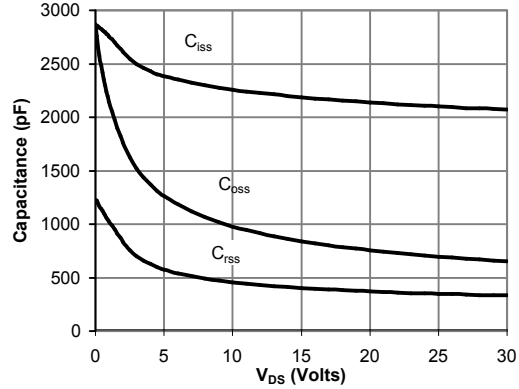

Figure 8: Capacitance Characteristics

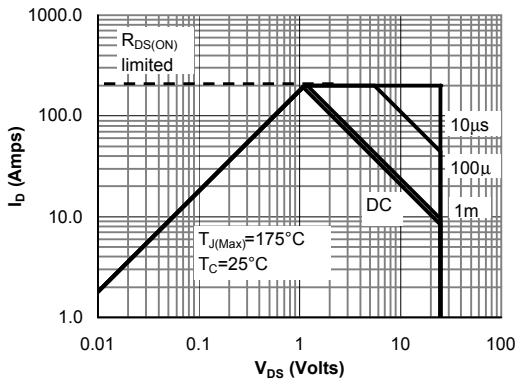

Figure 9: Maximum Forward Biased Safe Operating Area (Note F)

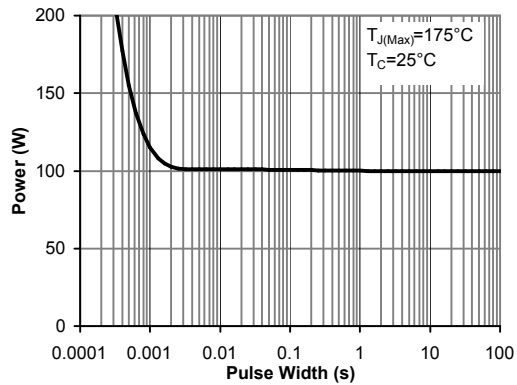

Figure 10: Single Pulse Power Rating Junction-to-Case (Note F)

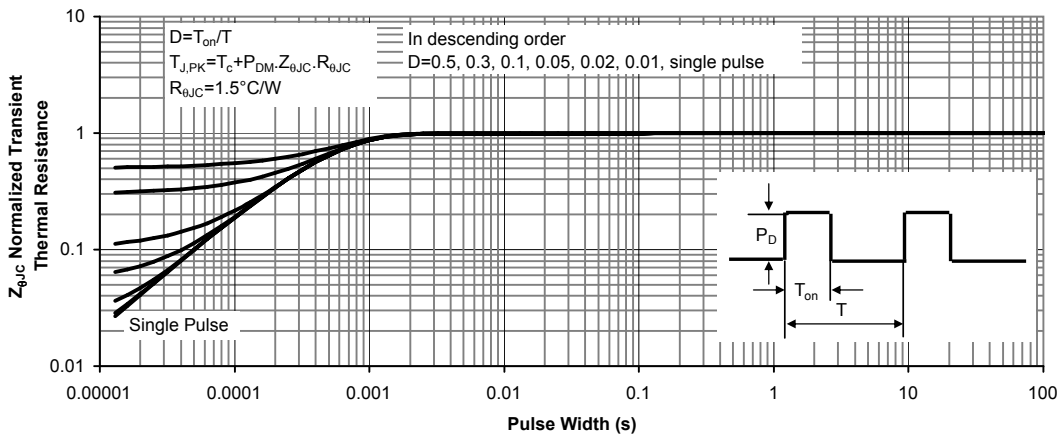

Figure 11: Normalized Maximum Transient Thermal Impedance (Note F)

TYPICAL ELECTRICAL AND THERMAL CHARACTERISTICS

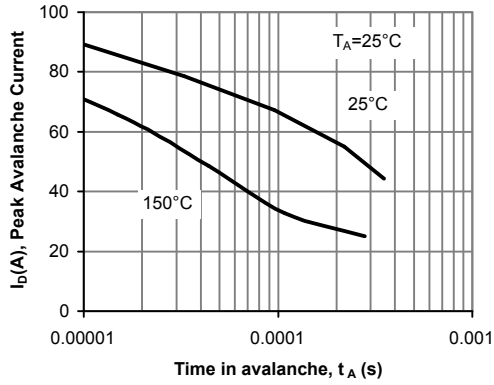

Figure 12: Single Pulse Avalanche capability

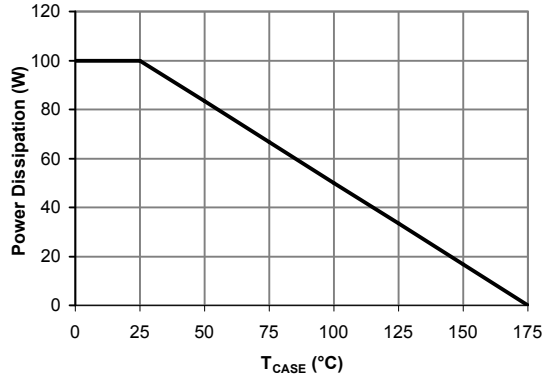

Figure 13: Power De-rating (Note B)

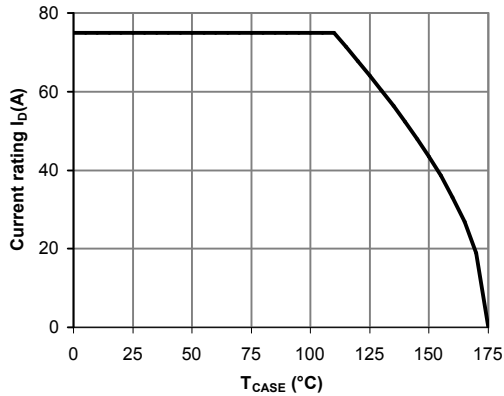

Figure 14: Current De-rating (Note B)

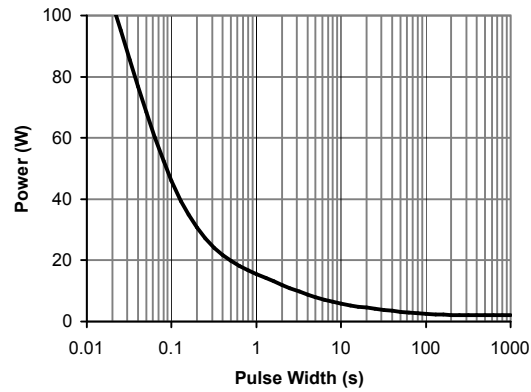

Figure 15: Single Pulse Power Rating Junction-to-Ambient (Note H)

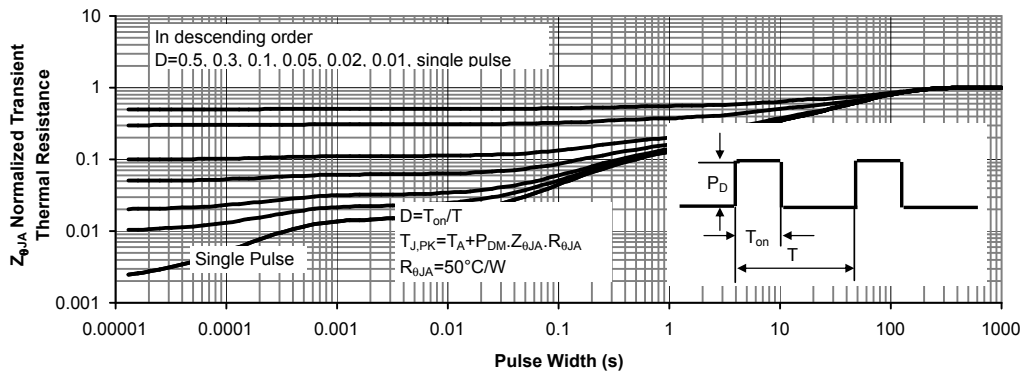
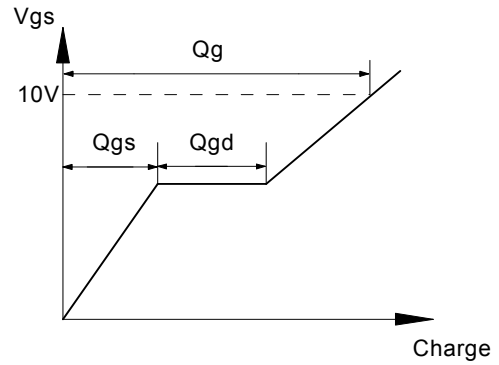
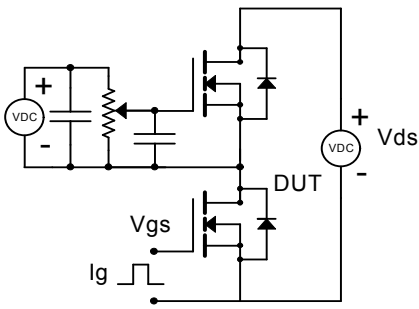
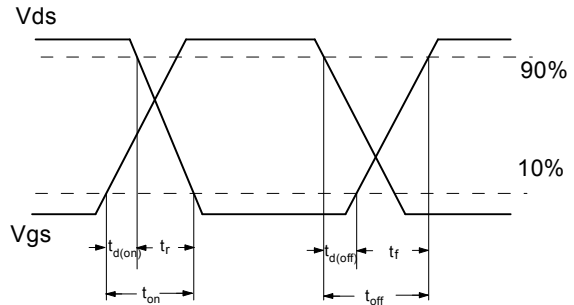
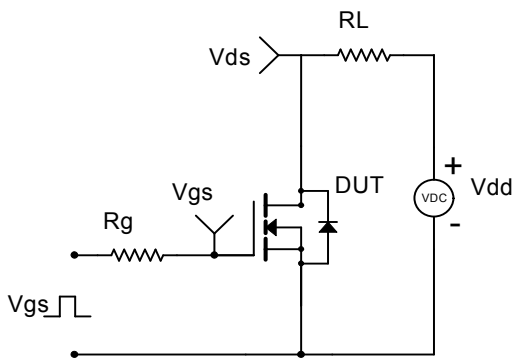

Figure 16: Normalized Maximum Transient Thermal Impedance (Note H)

Gate Charge Test Circuit & Waveform



Resistive Switching Test Circuit & Waveforms



Unclamped Inductive Switching (UIS) Test Circuit & Waveforms

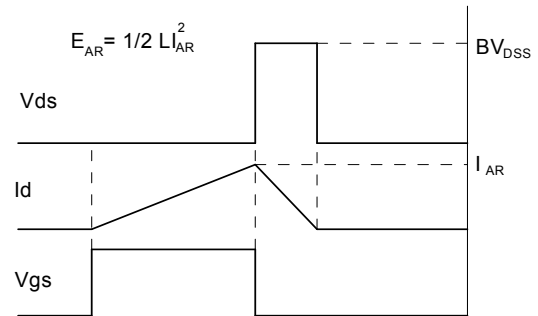
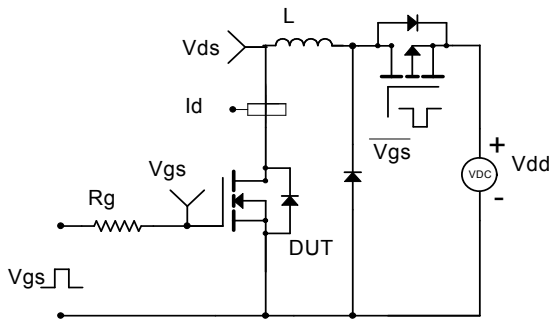

Diode Recovery Test Circuit & Waveforms

