

Surface Mount Fuse, 11 x 4.6 mm, Quick-Acting F, 250 VAC, 250 DC



IEC 60127-4 · 250 VAC · 250 VDC · Quick-Acting F

**Description**

- Directly solderable on printed circuit boards

Standards

- IEC 60127-4/2
 - UL 248-14
 - CSA C22.2 no. 248.14

Approvals

- VDE License Number: 106328
 - UL File Number: E41599

Applications

- Primary Protection on SMD PCB
 - Industrial electronic



References

[General Product Information](#)
[Packaging Details](#)
[Fuse Kit Fuse Kit OMF](#)

Weblinks

[Approvals, RoHS, CHINA-RoHS, e-Store, Distributor-Stock-Check, Accessories, Product Change Notification \(PCN\)](#)

Technical Data

Rated Voltage	250 VAC, 250 VDC
Rated Current	0.25 - 4 A
Breaking Capacity	100 A
Characteristic	Quick-Acting F
Mounting	PCB, SMT
Admissible Ambient Air Temp.	-55 °C to 125 °C
Climatic Category	55/125/21 acc. to IEC 60068-1
Material: Housing	Thermoplastic, UL 94V-0
Material: Terminals	Tin-Plated Copper Alloy
Unit Weight	0.36 g
Storage Conditions	0 °C to 60 °C, max. 70% r.h.
Product Marking	  , Type, Current, Characteristic, Breaking Capacity, Approvals

Soldering Methods	Reflow, Wave
Solderability	245 °C / 3 sec acc. to IEC 60068-2-58, Test Td
Resistance to Soldering Heat	260 °C / 10 sec acc. to IEC 60068-2-58, Test Td
Load Humidity Test	MIL-STD-202, Method 103B (1000h @ 0.1*ln @ 0.85 r.H. @ 85°C)
Moisture Resistance Test	MIL-STD-202, Method 106E (50 cycles in a temp./mister chamber)
Terminal Strength	MIL-STD-202, Method 211A (Deflection of board 1 mm for 1 minute)
Thermal Shock	MIL-STD-202, Method 107D (200 air-to-air cycles from -55 to +125°C)
Case Resistance	acc. to EIA/IS-722, Test 4.7 >100 MΩ (between leads and body)
Mechanical Shock	MIL-STD-202, Method 213B (Shock 50gn, half sine wave, 11 ms)
Vibration, High Frequency	MIL-STD-202, Method 204D (Shock 20 gn, 20 min, 10-2 kHz, 12 cyc.)
Resistance to Solvents	MIL-STD-202, Method 215A
Flammability	min. UL 94V-1 (acc. to EIA/IS-722, Test 4.12)

Dimensions

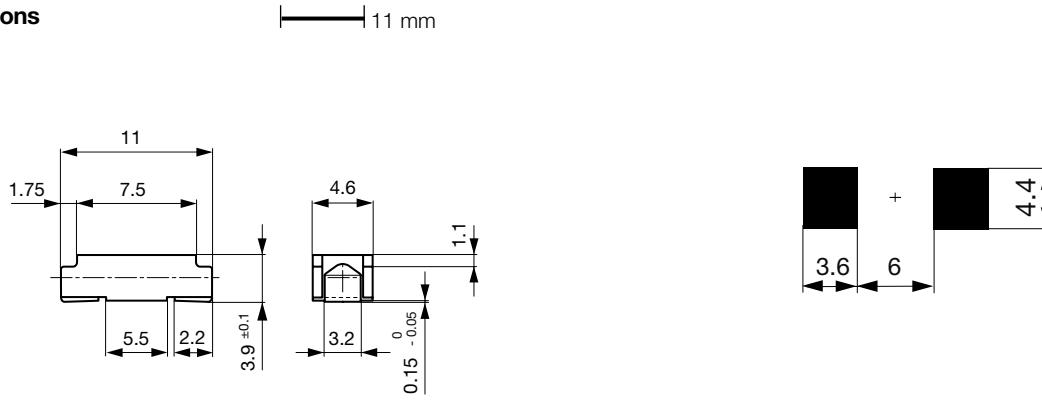





Soldering pads

Pre-Arcing Time

Rated Current In	1.25 x In min.	2.0 x In max.	10.0 x In min.	10.0 x In max.
0.25 A - 4 A	60 min	120 s	1 ms	10 ms

Variants

Rated Current [A]	Rated Voltage [VAC]	Rated Voltage [VDC]	Breaking Capacity	Voltage Drop 1.0 In max. [mV]	Voltage Drop 1.0 In typ. [mV]	Power Dissipation 1.25 I _n typ. [mW]	Melting I ² t 10.0 Intyp. [A ² s]	   	Order Number
0.25	250	250	1)	-	1100	480	0.012	● ● ●	3403.0010.xx
0.315	250	250	1)	-	1000	430	0.019	● ● ●	3403.0011.xx
0.4	250	250	1)	700	230	190	0.02	● ● ● ●	3403.0012.xx
0.5	250	250	1)	600	190	190	0.03	● ● ● ●	3403.0013.xx
0.63	250	250	1)	500	170	230	0.07	● ● ● ●	3403.0014.xx
0.8	250	250	1)	400	200	330	0.12	● ● ● ●	3403.0015.xx
1	250	250	1)	300	170	390	0.23	● ● ● ●	3403.0016.xx
1.25	250	250	1)	300	150	390	0.47	● ● ● ●	3403.0017.xx
1.6	250	250	1)	300	150	490	0.84	● ● ● ●	3403.0018.xx
2	250	250	1)	300	140	600	1.4	● ● ● ●	3403.0019.xx
2.5	250	250	1)	300	130	670	2.6	● ● ● ●	3403.0020.xx
3.15	250	250	1)	300	130	870	4.8	● ● ● ●	3403.0021.xx
4	250	250	1)	300	100	950	8.6	● ● ● ●	3403.0022.xx

1) 100 A @ 250 VAC/DC

Packaging Unit

.xx = .11 Plastic Bag (100 pcs.)
 .xx = .24 Blister Tape 33 cm Reel (2000 pcs.)

Time-Current-Curves

