



Spec. No.	PS-ND-0712
Rev.	A

# PRODUCT SPECIFICATION

**Model No : CSS-5160T9/CSS-5161T9**

## Descriptions:

- 0.50 Inch Single Digit Alphanumeric Display
- Emitting Color: Super-Bright Yellow



CUSTOMER APPROVED	APPROVED BY	CHECKED BY	PREPARED BY
SIGNATURES			

**CHINA SEMICONDUCTOR CORPORATION**

Address:2FL. NO.909,Chung-Cheng Road,  
Chung-Ho City Taipei Hsien,Taiwan.

Tel:886-2-2223-9696  
Fax:886-2-2223-9377

**OPTO PLUS TECHNOLOGIES CO.,LTD**

Address:696 Shun jiang Rd.,Ji Shan St.Shaoxing,  
ZheJiang,China

Tel:86-0575-8623888  
Fax:86-0575-8623112



<b>Spec. No.</b>	PS-ND-0712
<b>Rev.</b>	A

**Model No : CSS-5160T9/5161T9**

**Features -**

1. 0.50 inch (12.7 mm) digit height.
2. Case mold type.
3. RoHs compliant.
4. Low power consumption.
5. Easy mounting on P.C. board or socket.

**Device Selection Guide -**

Part No.	Chip		Description
	Material	Emitted Color	
<b>CSS-5160T9</b>	<b>AlGaInP</b>	<b>Super-Bright Yellow</b>	<b>Common Anode</b>
<b>CSS-5161T9</b>			<b>Common Cathode</b>

**Package Dimensions -**

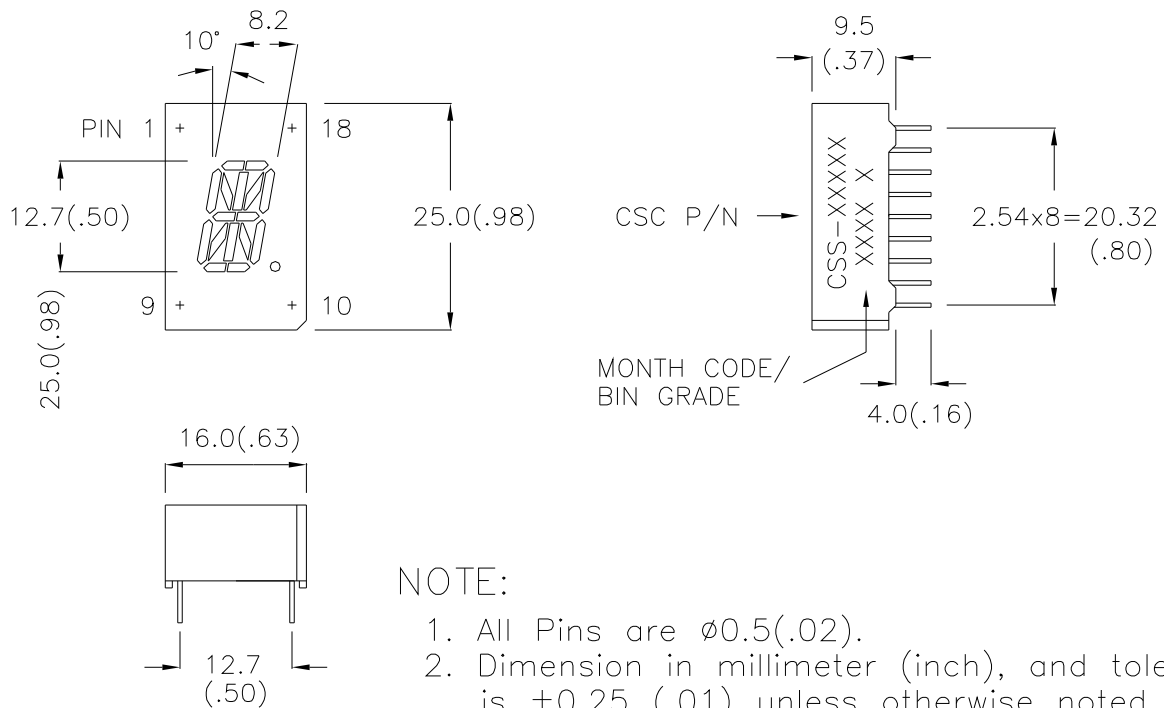

**NOTE:**

1. All Pins are  $\phi 0.5(.02)$ .
2. Dimension in millimeter (inch), and tolerance is  $\pm 0.25 (.01)$  unless otherwise noted.



Model No : CSS-5160T9/5161T9

Internal Circuit Diagrams -

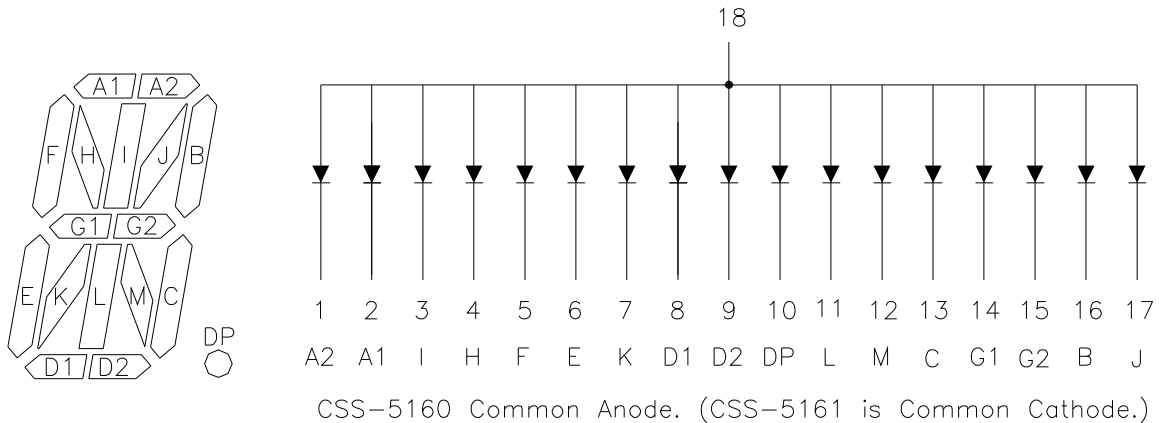

Absolute Maximum Rating -

(Ta=25°C)

Parameter	Symbol	Rating	Unit
Power Dissipation Per Dice	Pd	65	mW
Continuous Forward Current Per Dice	IAF	25	mA
Peak Current Per Dice (duty cycle 1/10, 1kHz)	IPF	90	mA
Derating Linear From 25°C Per Dice	-	0.33	mA/°C
Reverse Voltage Per Dice	VR	5	V
Operating Temperature	Topr	-25 ~ +85	°C
Storage Temperature	Tstg	-25 ~ +85	°C
Solder temperature 1/16 inch below seating plane for 3 seconds at 260°C			



Model No : CSS-5160T9/5161T9

■ Electro-optical Characteristics -

(Ta=25°C)

Parameter	Symbol	Min.	Typ.	Max.	Unit	Condition
Forward Voltage Per Segment	VF	-	2.1	2.6	V	IF=20mA
Luminous Intensity Per Segment	Iv	-	15	-	mcd	IF=10mA
Peak Emission Wavelength	$\lambda_p$	-	592	-	nm	IF=20mA
Spectrum Radiation Bandwidth	$\Delta \lambda$	-	20	-	nm	IF=20mA
Reverse Current	IR	-	-	100	$\mu A$	VR=5V
Luminous Intensity Matching Ratio	IV-m	-	-	2 : 1	-	IF=20mA



Model No : CSS-5160T9/5161T9

■ Typical Electrical / Optical Characteristics Curves -

(Ta = 25°C Unless Otherwise Noted)

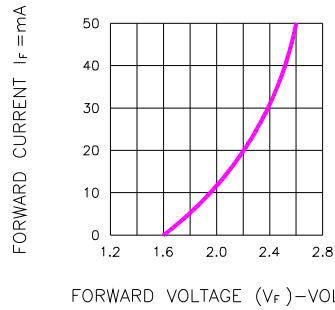

Fig.1 FORWARD CURRENT VS. FORWARD VOLTAGE

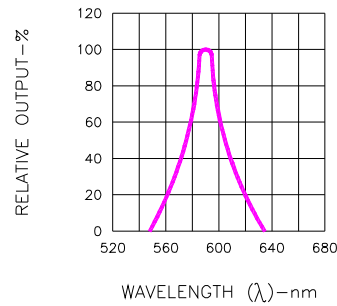

Fig.2 SPECTRAL RESPONSE

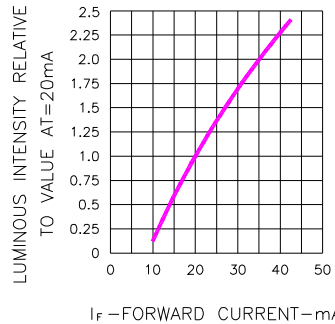

Fig.3 RELATIVE LUMINOUS INTENSITY VS. FORWARD CURRENT

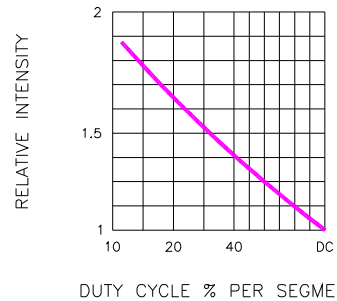

Fig.5 LUMINOUS INTENSITY VS. DUTY CYCLE

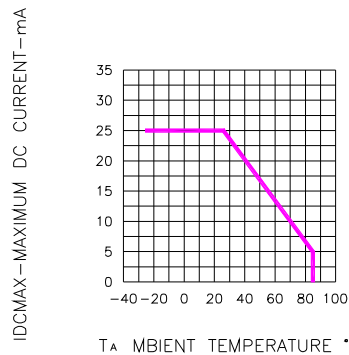

Fig.4 MAXIMUM ALLOWABLE DC CURRENT PER SEGMENT VS. A FUNCTION OF AMBIENT TEMPERATURE

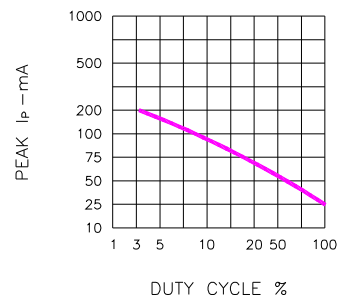

Fig.6 MAX PEAK CURRENT VS. DUTY CYCLE % (REFRESH RATE f=1 KHz)



Spec. No.	PS-ND-0712
Rev.	A

Model No : CSS-516T9/5161T9

### ■ Package Dimensions

S = Single Digit Display  
Dice Code  
CSS-516xX-XX  
Segment Resin Color Code.  
Surface silk Screen Ink Code.

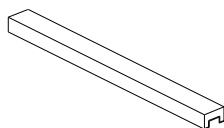

1 TUBE From Box = 20 PCS

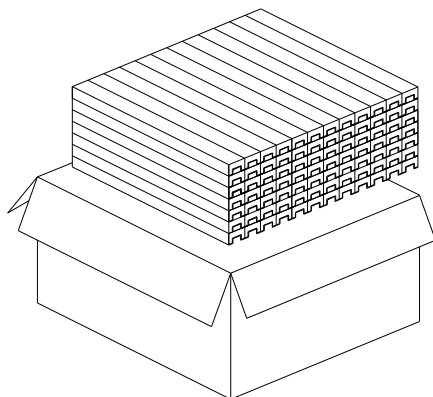

1 BOX= 60 TUBE From Box  
Q'TY: 1200 PCS.



1 CARTON = 3 BOX.  
Q'TY: 3600 PCS.

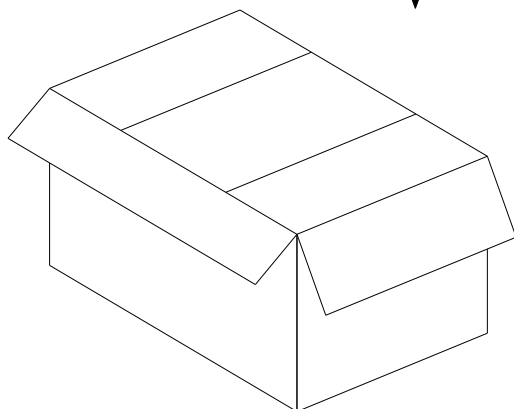

CARTON SIZE:  
L540xW485xH305mm

Note: The specifications are subject to change without notice. Please contact us for updated information.