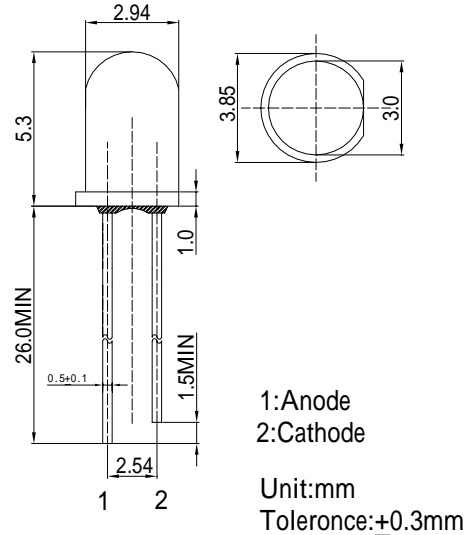

Features

- High Luminous LEDs
- 3mm Standard Directivity
- Superior Weather-resistance
- Flashing Type
- Water Clear Type

Applications

- Toys
- Games
- Audio
- Other Lighting

Outline Dimension

■ Absolute Maximum Rating (Ta=25 °C)

Item	Symbol	Value	Unit
Oscillator Frequency	Fled	1.8	Hz
Power Supply	Voltage	4.5	V
Operating Temperature	Topr	-30 ~ +85	
Storage Temperature	Tstg	-40 ~ +100	
Lead Soldering Temperature	Tsol	260 /5sec	-

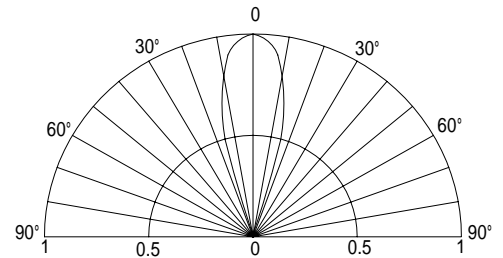
*Pulse width Max.10ms Duty ratio max 1/10

■ Directivity

■ Electrical -Optical Characteristics (Ta=25 °C)

Item	Symbol	Condition	Min.	Typ.	Max.	Unit
DC Forward Voltage	Vdd	I _F =20mA	3.0	3.3	4.5	V
DC Reverse Current	I _R	V _R =5V	-	-	10	μA
Domi. Wavelength*	λ _D	I _F =20mA	620	625	630	nm
Luminous Intensity*	I _v	I _F =20mA	-	2000	-	mcd
50% Power Angle	2θ _{1/2}	I _F =20mA	-	30	-	deg

*1 Tolerance of dominant wavelength is +1nm

*2 Tolerance of luminous intensity is +15%