

**FEATURES**

- \* 1.2 inch (30.42 mm) MATRIX HEIGHT.
- \* LOW POWER REQUIREMENT.
- \* SINGLE PLANE, WIDE VIEWING ANGLE.
- \* SOLID STATE RELIABILITY.
- \* 5× 7 ARRAY WITH X-Y SELECT.
- \* COMPATIBLE WITH USASCII AND EBCDIC CODES.
- \* STACKABLE HORIZONTALLY.
- \* CATEGORIZED FOR LUMINOUS INTENSITY.

**DESCRIPTION**

The LTP-1557AY-01 is a 1.2 inch (30.42 mm) matrix height 5× 7 dot matrix display. This device utilizes yellow LED chips, which are made from GaAsP on a transparent GaP substrate, and has a black face and white dot color.

**DEVICE**

<b>PART NO.</b>	<b>DESCRIPTION</b>
YELLOW	CATHODE COLUMN
LTP-1557AY-01	ANODE ROW

## PACKAGE DIMENSIONS

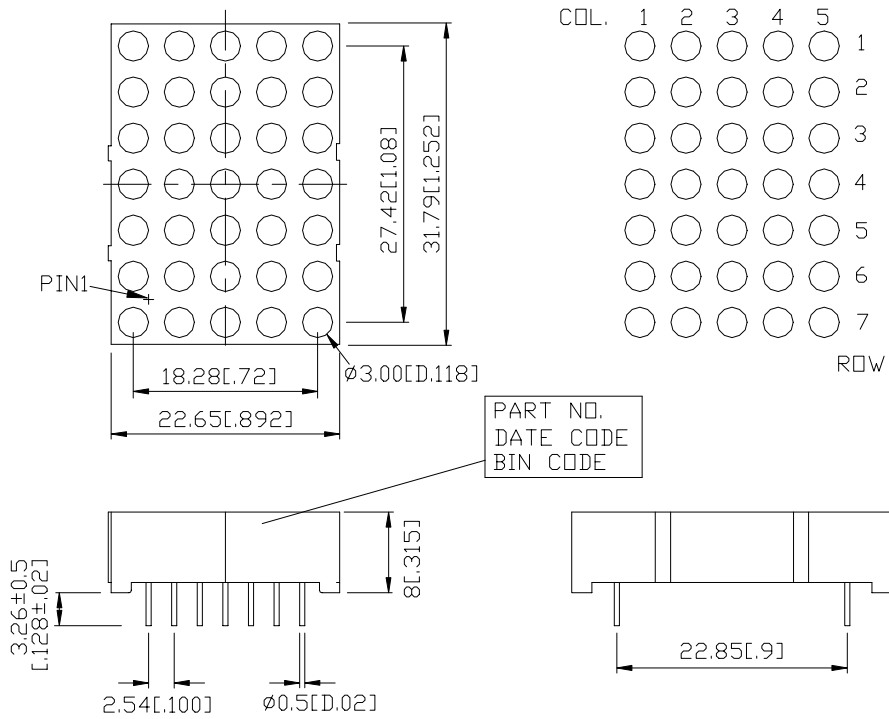

NOTES: All dimensions are in millimeters. Tolerance is  $\pm 0.25$  mm (0.01") unless otherwise noted.

## INTERNAL CIRCUIT DIAGRAM

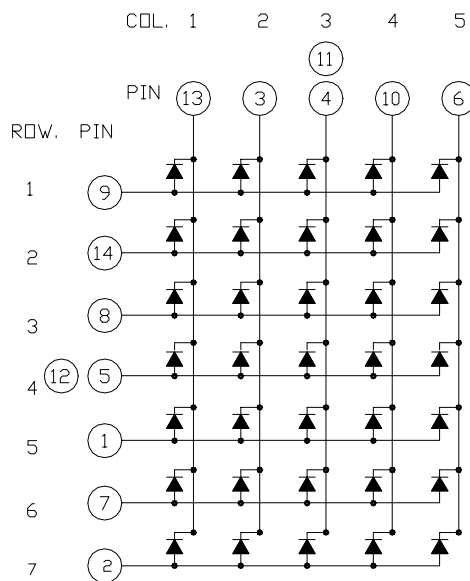

**PIN CONNECTION**

<b>No.</b>	<b>CONNECTION</b>
1	ANODE ROW 5
2	ANODE ROW 7
3	CATHODE COLUMN 2
4	CATHODE COLUMN 3*1
5	ANODE ROW 4*2
6	CATHODE COLUMN 5
7	ANODE ROW 6
8	ANODE ROW 3
9	ANODE ROW 1
10	CATHODE COLUMN 4
11	CATHODE COLUMN 3*1
12	ANODE ROW 4*2
13	CATHODE COLUMN 1
14	ANODE ROW 2

NOTES : 1.Pin 4 & 11 are internally connected.  
2.Pin 5 & 12 are internally connected.

## ABSOLUTE MAXIMUM RATING AT Ta=25°C

PARAMETER	MAXIMUM RATING	UNIT
Average Power Dissipation Per Dot	32	mW
Peak Forward Current Per Dot	80	mA
Average Forward Current Per Dot	10	mA
Derating Linear From 25°C Per Dot	0.12	mA/°C
Reverse Voltage Per Dot	5	V
Operating Temperature Range	-35°C to +85°C	
Storage Temperature Range	-35°C to +85°C	
Solder Temperature: max 260°C for max 3sec at 1.6mm[1/16inch] below seating plane.		

## ELECTRICAL / OPTICAL CHARACTERISTICS AT Ta=25°C

PARAMETER	SYMBOL	MIN.	TYP.	MAX.	UNIT	TEST CONDITION
Average Luminous Intensity	I <sub>v</sub>	1780	4000		μcd	I <sub>p</sub> =80mA 1/16Duty
Peak Emission Wavelength	λ <sub>p</sub>		585		nm	I <sub>F</sub> =20mA
Spectral Line Half-Width	Δλ		35		nm	I <sub>F</sub> =20mA
Dominant Wavelength	λ <sub>d</sub>		588		nm	I <sub>F</sub> =20mA
Forward Voltage any Dot	V <sub>F</sub>		2.1	2.6	V	I <sub>F</sub> =20mA
			3.0	3.7		I <sub>F</sub> =80mA
Reverse Current any Dot	I <sub>R</sub>			100	μA	V <sub>R</sub> =5V
Luminous Intensity Matching Ratio	I <sub>v</sub> -m			2:1		I <sub>F</sub> =10mA

Note: Luminous intensity is measured with a light sensor and filter combination that approximates the CIE (Commision Internationale De L'Eclairage) eye-response curve.

\* Binning Condition:

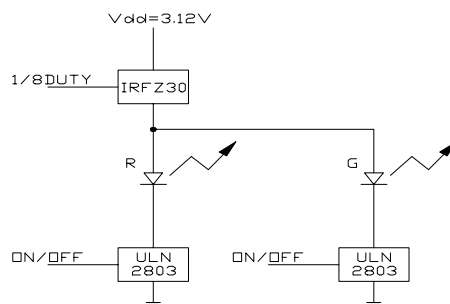

## TYPICAL ELECTRICAL / OPTICAL CHARACTERISTIC CURVES

(25°C Ambient Temperature Unless Otherwise Noted)

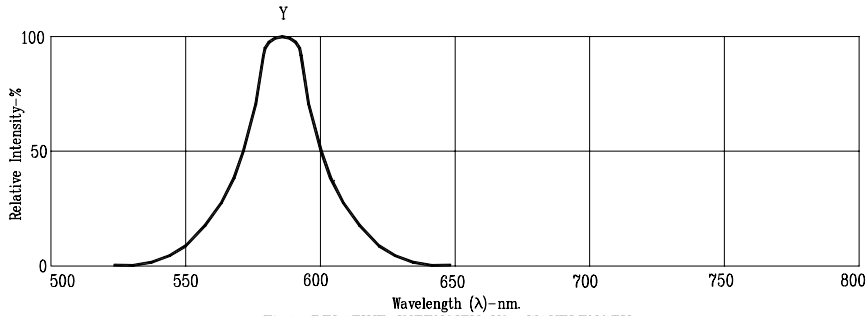

Fig1. RELATIVE INTENSITY VS. WAVELENGTH

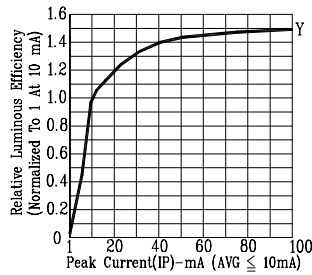

Fig2. RELATIVE LUMINOUS EFFICIENCY (LUMINOUS INTENSITY PER UNIT CURRENT) VS. PEAK CURRENT (REFRESH RATE 1KHz)

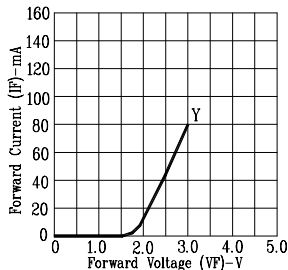

Fig3. FORWARD CURRENT VS. FORWARD VOLTAGE

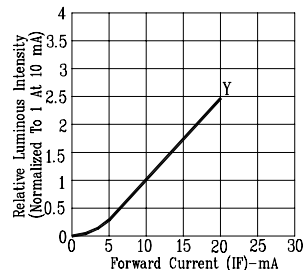

Fig4. RELATIVE LUMINOUS INTENSITY VS. FORWARD CURRENT

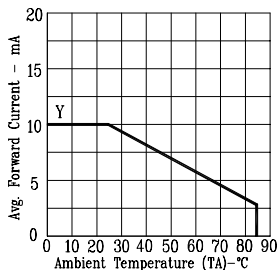

Fig8. MAX. AVERAGE FORWARD CURRENT VS. AMBIENT TEMPERATURE.

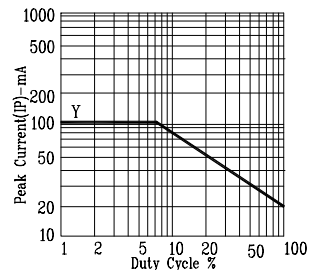

Fig6. MAX. PEAK CURRENT VS. DUTY CYCLE % (REFRESH RATE 1KHz)

NOTE : Y= YELLOW