

# SKM 600GB066D

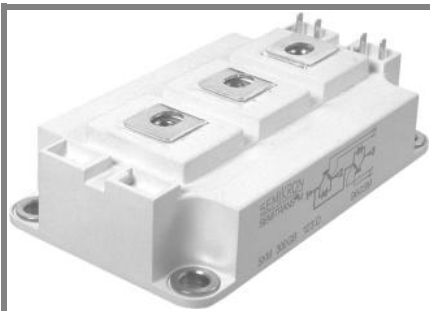

**SEMITRANS® 3**

## Trench IGBT Modules

**SKM 600GB066D**

### Features

- Trench = Trenchgate technology
- $V_{CE(sat)}$  with positive temperature coefficient
- High short circuit capability, self limiting to  $6 \times I_C$

### Typical Applications

- AC inverter drives
- UPS
- Electronic welders

### Remarks

- Case temp. limited. to  $T = 125^\circ\text{C}$ , recomb.  $T_{op} = -40 \dots +150^\circ\text{C}$ , product rel. results valid for  $T_j \leq 150^\circ\text{C}$
- SC data:  $t_p \leq 6\mu\text{s}$ ;  $V_{GE} \leq 15\text{V}$ ;  $T_j = 150^\circ\text{C}$ ;  $V_{CC} \leq 360\text{V}$ , use of soft  $R_G$  necessary !
- Take care of over-voltage caused by stray induct.
- $I_{DC} \leq 500\text{A}$  for  $T_{Terminal} = 100^\circ\text{C}$



**GB**

Absolute Maximum Ratings		$T_{case} = 25^\circ\text{C}$ , unless otherwise specified		
Symbol	Conditions	Values	Units	
<b>IGBT</b>				
$V_{CES}$	$T_j = 25^\circ\text{C}$	600	V	
$I_C$	$T_j = 175^\circ\text{C}$	$T_c = 25^\circ\text{C}$	760	A
		$T_c = 80^\circ\text{C}$	570	A
$I_{CRM}$	$I_{CRM} = 1,33 \times I_{Cnom}$	800	A	
$V_{GES}$		$\pm 20$	V	
$t_{psc}$	$V_{CC} = 360\text{V}$ ; $V_{GE} \leq 15\text{V}$ ; $T_j = 150^\circ\text{C}$ $V_{CES} < 600\text{V}$	6	$\mu\text{s}$	
<b>Inverse Diode</b>				
$I_F$	$T_j = 175^\circ\text{C}$	$T_c = 25^\circ\text{C}$	700	A
		$T_c = 80^\circ\text{C}$	510	A
$I_{FRM}$	$I_{FRM} = 1,33 \times I_{Fnom}$	800	A	
<b>Module</b>				
$I_{t(RMS)}$		500	A	
$T_{vj}$		- 40 + 175	$^\circ\text{C}$	
$T_{stg}$		- 40 + 125	$^\circ\text{C}$	
$V_{isol}$	AC, 1 min.	4000	V	

Characteristics		$T_{case} = 25^\circ\text{C}$ , unless otherwise specified			
Symbol	Conditions	min.	typ.	max.	Units
<b>IGBT</b>					
$V_{GE(th)}$	$V_{GE} = V_{CE}$ ; $I_C = 9,6\text{mA}$	5	5,8	6,5	V
$I_{CES}$	$V_{GE} = 0\text{V}$ ; $V_{CE} = V_{CES}$		0,3	0,9	mA
$V_{CE0}$		$T_j = 25^\circ\text{C}$	0,9	1	V
		$T_j = 150^\circ\text{C}$	0,85	0,9	V
$r_{CE}$	$V_{GE} = 15\text{V}$	$T_j = 25^\circ\text{C}$	0,9	1,5	m $\Omega$
		$T_j = 150^\circ\text{C}$	1,4	2	m $\Omega$
$V_{CE(sat)}$	$I_{Cnom} = 600\text{A}$ ; $V_{GE} = 15\text{V}$	$T_j = 25^\circ\text{C}_{chiplev.}$	1,45	1,9	V
		$T_j = 150^\circ\text{C}_{chiplev.}$	1,7	2,1	V
$C_{ies}$	$V_{CE} = 25$ ; $V_{GE} = 0\text{V}$	$f = 1\text{MHz}$	37		nF
$C_{oes}$			2,3		nF
$C_{res}$			1,1		nF
$Q_G$	$V_{GE} = -8\text{V} \dots +15\text{V}$		4400		nC
$R_{Gint}$	$T_j = ^\circ\text{C}$		0,5		$\Omega$
$t_{d(on)}$	$R_{Gon} = 1,5\ \Omega$	$V_{CC} = 300\text{V}$ $I_C = 600\text{A}$	270		ns
$t_r$			77		ns
$E_{on}$	$R_{Goff} = 1,5\ \Omega$	$T_j = 150^\circ\text{C}$ $V_{GE} = -8\text{V}/+15\text{V}$	7,5		mJ
$t_{d(off)}$			670		ns
$t_f$			77		ns
$E_{off}$			29,5		mJ
$R_{th(j-c)}$	per IGBT			0,08	K/W

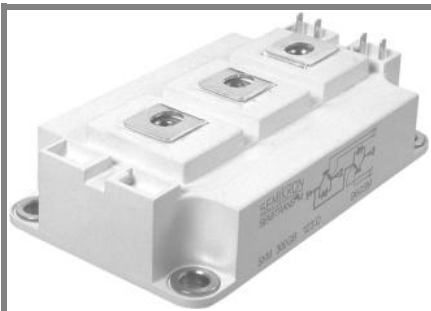

**SEMITRANS® 3**

## Trench IGBT Modules

### SKM 600GB066D

#### Features

- Trench = Trenchgate technology
- $V_{CE(sat)}$  with positive temperature coefficient
- High short circuit capability, self limiting to  $6 \times I_C$

#### Typical Applications

- AC inverter drives
- UPS
- Electronic welders

#### Remarks

- Case temp. limited. to  $T = 125^\circ\text{C}$ , recomb.  $T_{op} = -40 \dots +150^\circ\text{C}$ , product rel. results valid for  $T_j \leq 150^\circ\text{C}$
- SC data:  $t_p \leq 6\mu\text{s}$ ;  $V_{GE} \leq 15\text{V}$ ;  $T_j = 150^\circ\text{C}$ ;  $V_{CC} \leq 360\text{V}$ , use of soft  $R_G$  necessary !
- Take care of over-voltage caused by stray induct.
- $I_{DC} \leq 500\text{A}$  for  $T_{Terminal} = 100^\circ\text{C}$



**GB**

#### Characteristics

Symbol	Conditions	min.	typ.	max.	Units
<b>Inverse Diode</b>					
$V_F = V_{EC}$	$I_{Fnom} = 600\text{ A}$ ; $V_{GE} = 0\text{ V}$ $T_j = 25^\circ\text{C}_{chiplev.}$		1,4	1,6	V
$V_{F0}$	$T_j = 25^\circ\text{C}$		0,95	1	V
$r_F$	$T_j = 25^\circ\text{C}$		0,8	1	mΩ
$I_{RRM}$	$I_F = 600\text{ A}$ $T_j = 150^\circ\text{C}$		580		A
$Q_{rr}$	$di/dt = 8600\text{ A}/\mu\text{s}$		105		μC
$E_{rr}$	$V_{GE} = -8\text{ V}$ ; $V_{CC} = 300\text{ V}$		25		mJ
$R_{th(j-c)D}$	per diode			0,125	K/W
<b>Module</b>					
$L_{CE}$			15	20	nH
$R_{CC+EE}$	res., terminal-chip $T_{case} = 25^\circ\text{C}$		0,35		mΩ
	$T_{case} = 125^\circ\text{C}$		0,5		mΩ
$R_{th(c-s)}$	per module			0,038	K/W
$M_s$	to heat sink M6	3		5	Nm
$M_t$	to terminals M6	2,5		5	Nm
w				325	g

This is an electrostatic discharge sensitive device (ESDS), international standard IEC 60747-1, Chapter IX.

This technical information specifies semiconductor devices but promises no characteristics. No warranty or guarantee expressed or implied is made regarding delivery, performance or suitability.

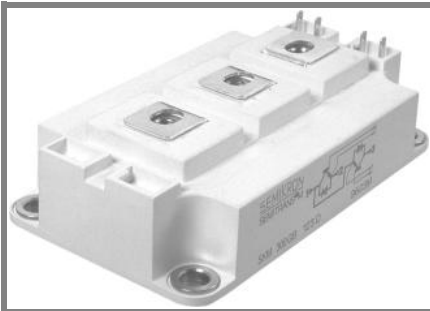

**SEMITRANS® 3**

## Trench IGBT Modules

### SKM 600GB066D

#### Features

- Trench = Trenchgate technology
- $V_{CE(sat)}$  with positive temperature coefficient
- High short circuit capability, self limiting to  $6 \times I_C$

#### Typical Applications

- AC inverter drives
- UPS
- Electronic welders

#### Remarks

- Case temp. limited. to  $T = 125^\circ\text{C}$ , recomb.  $T_{op} = -40 \dots +150^\circ\text{C}$ , product rel. results valid for  $T_j \leq 150^\circ\text{C}$
- SC data:  $t_p \leq 6\mu\text{s}$ ;  $V_{GE} \leq 15\text{V}$ ;  $T_j = 150^\circ\text{C}$ ;  $V_{cc} \leq 360\text{V}$ , use of soft  $R_G$  necessary !
- Take care of over-voltage caused by stray induct.
- $I_{DC} \leq 500\text{A}$  for  $T_{Terminal} = 100^\circ\text{C}$



**GB**

$Z_{th}$			
Symbol	Conditions	Values	Units
$Z_{th(j-c)I}$			
$R_{\theta i}$	$i = 1$	48,4	mk/W
$R_{\theta i}$	$i = 2$	19,5	mk/W
$R_{\theta i}$	$i = 3$	3,1	mk/W
$R_{\theta i}$	$i = 4$	4	mk/W
$\tau_{\theta i}$	$i = 1$	0,054	s
$\tau_{\theta i}$	$i = 2$	0,0144	s
$\tau_{\theta i}$	$i = 3$	0,0012	s
$\tau_{\theta i}$	$i = 4$	0,0026	s
$Z_{th(j-c)D}$			
$R_{\theta i}$	$i = 1$	80	mk/W
$R_{\theta i}$	$i = 2$	33	mk/W
$R_{\theta i}$	$i = 3$	10,5	mk/W
$R_{\theta i}$	$i = 4$	1,5	mk/W
$\tau_{\theta i}$	$i = 1$	0,054	s
$\tau_{\theta i}$	$i = 2$	0,01	s
$\tau_{\theta i}$	$i = 3$	0,0007	s
$\tau_{\theta i}$	$i = 4$	0,0019	s

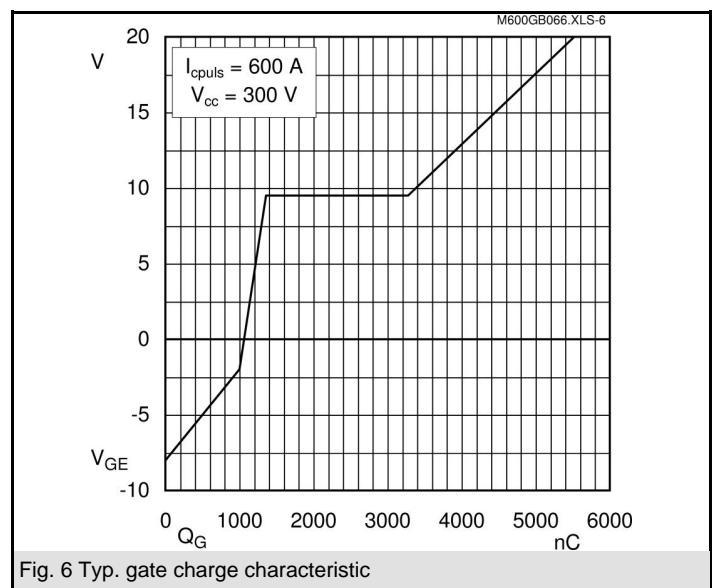
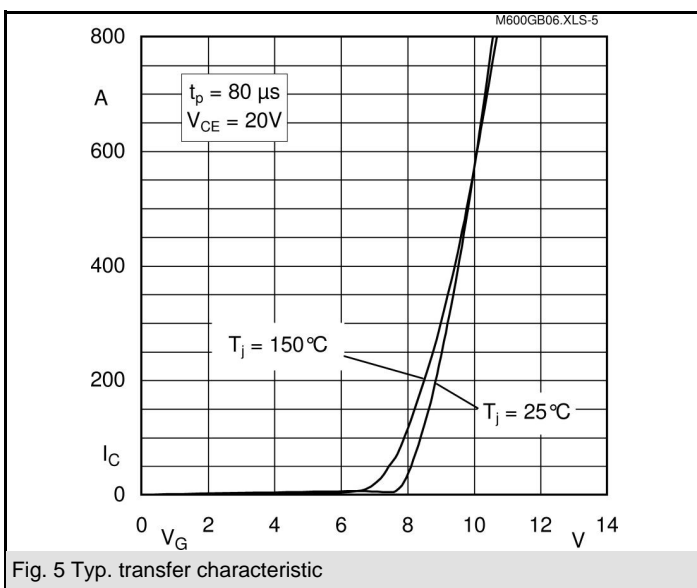
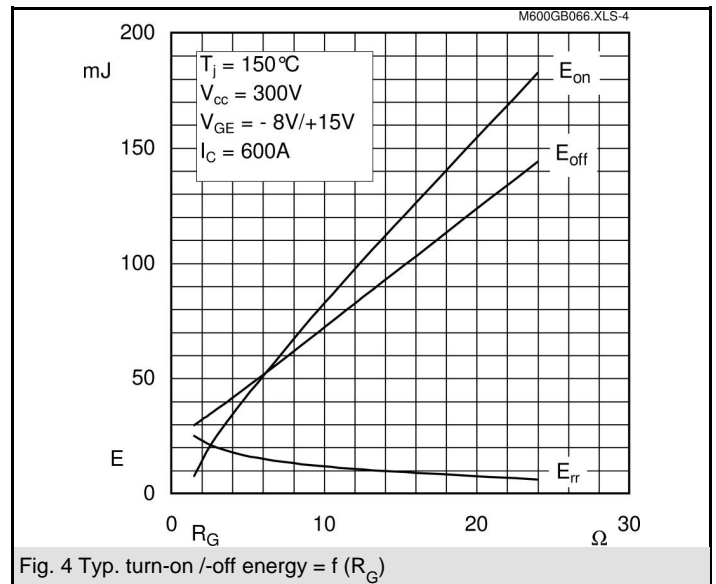
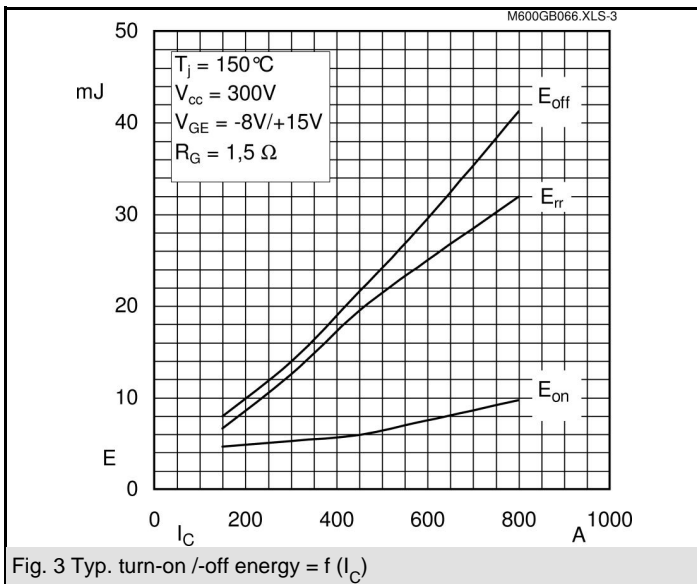
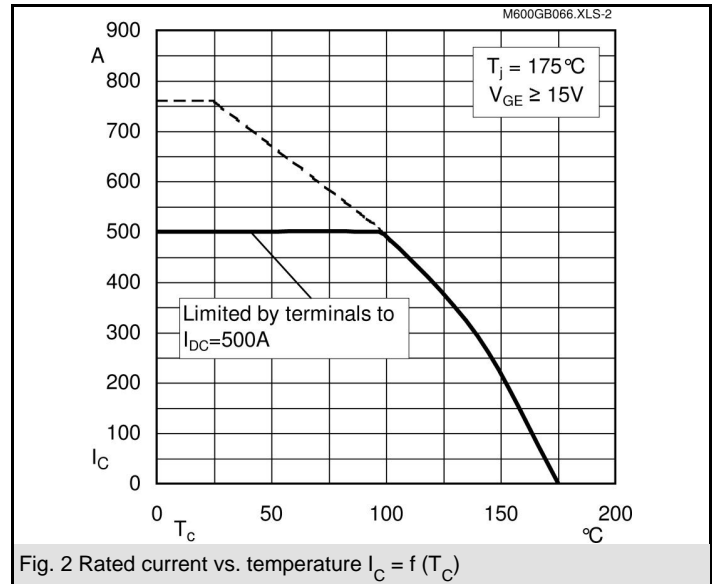
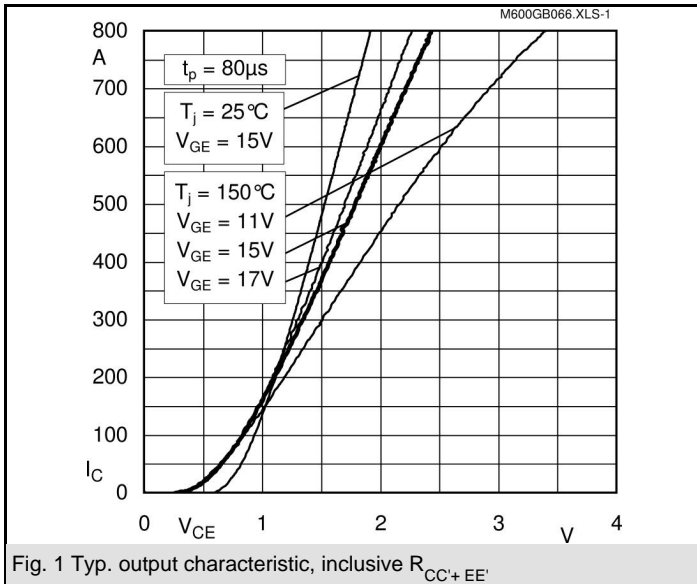

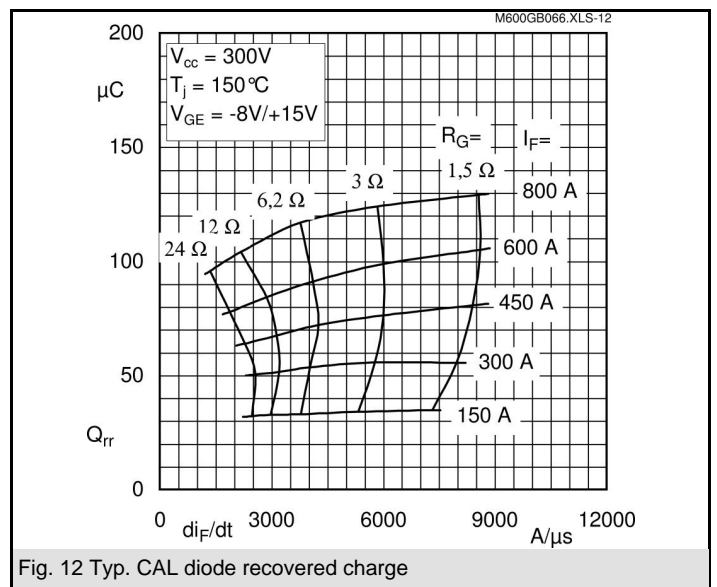
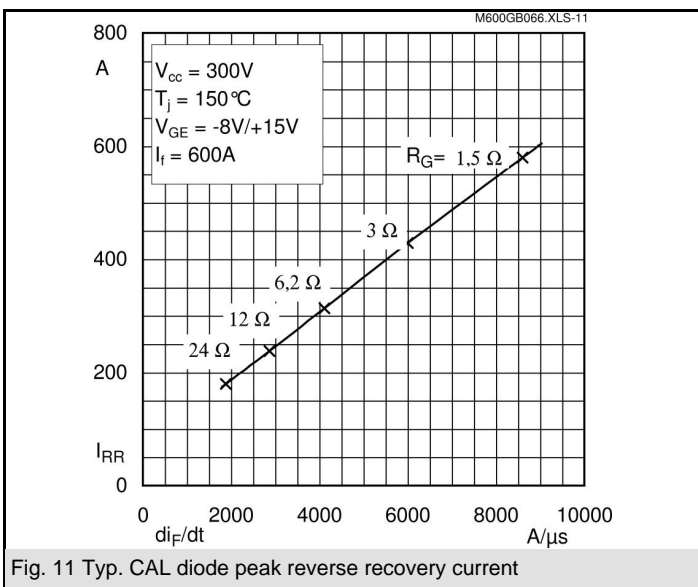
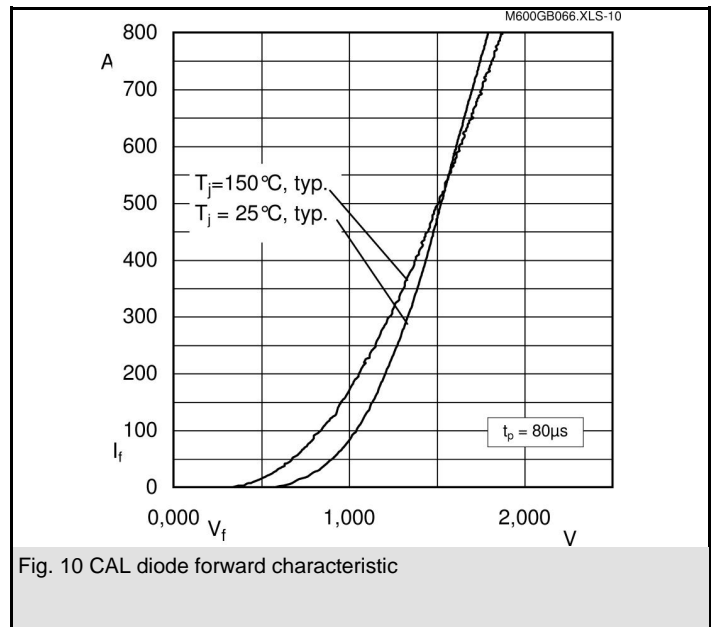
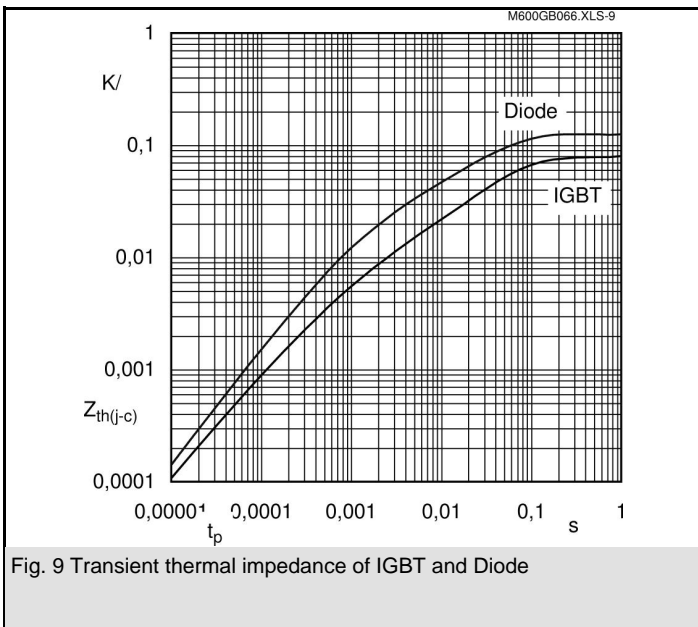
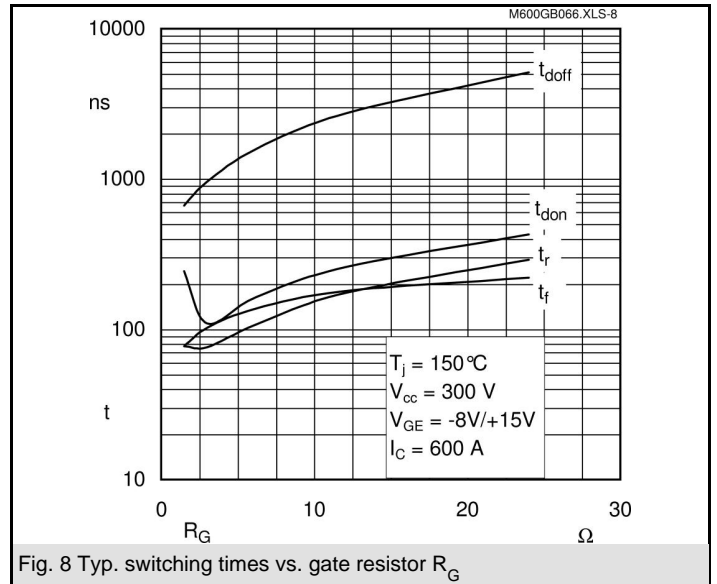
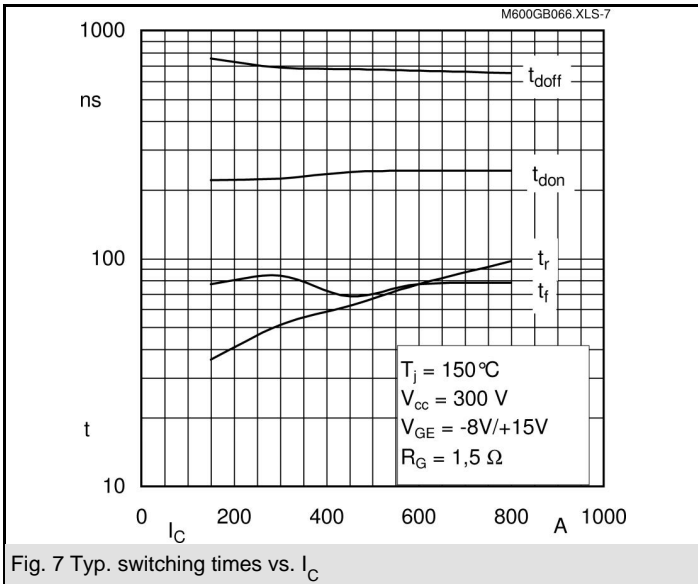

# SKM 600GB066D

UL recognized, file no. E 63 532

CASED56

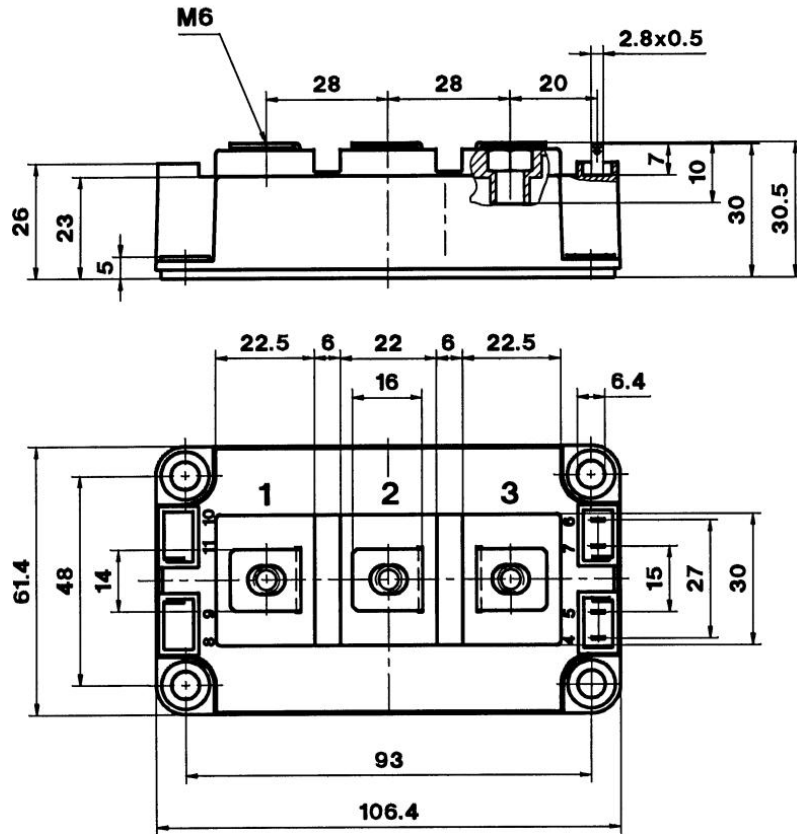

Case D 56

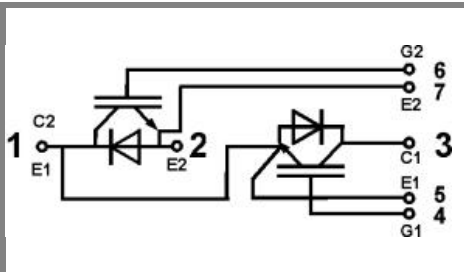

GB

Case D56