

Buck chopper Super Junction MOSFET Power Module

$V_{DSS} = 900V$
 $R_{DSon} = 60m\Omega \text{ max @ } T_j = 25^\circ C$
 $I_D = 59A \text{ @ } T_c = 25^\circ C$

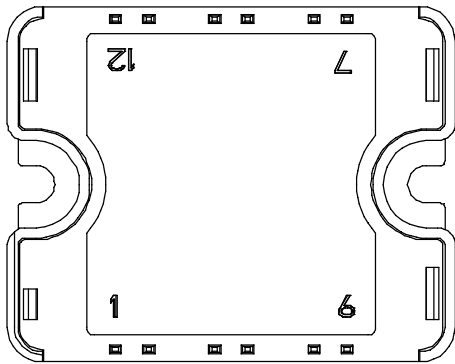
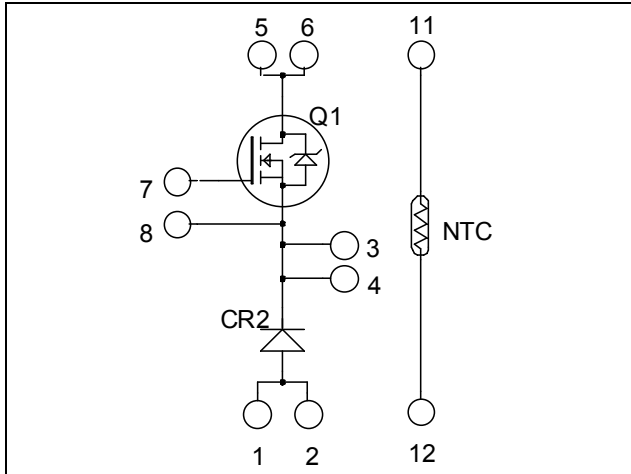

Pins 1/2 ; 3/4 ; 5/6 must be shorted together

Application

- AC and DC motor control
- Switched Mode Power Supplies

Features

- **COOLMOS** Power Semiconductors
 - Ultra low R_{DSon}
 - Low Miller capacitance
 - Ultra low gate charge
 - Avalanche energy rated
 - Very rugged
- Kelvin source for easy drive
- Very low stray inductance
- Internal thermistor for temperature monitoring
- High level of integration

Benefits

- Outstanding performance at high frequency operation
- Direct mounting to heatsink (isolated package)
- Low junction to case thermal resistance
- Solderable terminals both for power and signal for easy PCB mounting
- Low profile
- RoHS Compliant

Absolute maximum ratings

Symbol	Parameter	Max ratings	Unit
V_{DSS}	Drain - Source Breakdown Voltage	900	V
I_D	Continuous Drain Current	$T_c = 25^\circ C$	59
		$T_c = 80^\circ C$	44
I_{DM}	Pulsed Drain current	150	A
V_{GS}	Gate - Source Voltage	± 20	V
R_{DSon}	Drain - Source ON Resistance	60	$m\Omega$
P_D	Maximum Power Dissipation	$T_c = 25^\circ C$	462
I_{AR}	Avalanche current (repetitive and non repetitive)	8.8	A
E_{AR}	Repetitive Avalanche Energy	2.9	mJ
E_{AS}	Single Pulse Avalanche Energy	1940	

CAUTION: These Devices are sensitive to Electrostatic Discharge. Proper Handling Procedures Should Be Followed. See application note APT0502 on www.microsemi.com

All ratings @ $T_j = 25^\circ\text{C}$ unless otherwise specified

Electrical Characteristics

Symbol	Characteristic	Test Conditions	Min	Typ	Max	Unit
I_{DSS}	Zero Gate Voltage Drain Current	$V_{GS} = 0V, V_{DS} = 900V$ $T_j = 25^\circ\text{C}$			200	μA
		$V_{GS} = 0V, V_{DS} = 900V$ $T_j = 125^\circ\text{C}$		1000		
$R_{DS(on)}$	Drain – Source on Resistance	$V_{GS} = 10V, I_D = 52A$		50	60	$\text{m}\Omega$
$V_{GS(th)}$	Gate Threshold Voltage	$V_{GS} = V_{DS}, I_D = 6\text{mA}$	2.5	3	3.5	V
I_{GSS}	Gate – Source Leakage Current	$V_{GS} = \pm 20V, V_{DS} = 0V$			200	nA

Dynamic Characteristics

Symbol	Characteristic	Test Conditions	Min	Typ	Max	Unit
C_{iss}	Input Capacitance	$V_{GS} = 0V; V_{DS} = 100V$ $f = 1\text{MHz}$		13.6		nF
C_{oss}	Output Capacitance			0.66		
Q_g	Total gate Charge	$V_{GS} = 10V$ $V_{Bus} = 400V$ $I_D = 52A$		540		nC
Q_{gs}	Gate – Source Charge			64		
Q_{gd}	Gate – Drain Charge			230		
$T_{d(on)}$	Turn-on Delay Time	Inductive Switching (125°C) $V_{GS} = 10V$ $V_{Bus} = 600V$ $I_D = 52A$ $R_G = 3.8\Omega$		70		ns
T_r	Rise Time			20		
$T_{d(off)}$	Turn-off Delay Time			400		
T_f	Fall Time			25		
E_{on}	Turn-on Switching Energy	Inductive switching @ 25°C $V_{GS} = 10V; V_{Bus} = 600V$ $I_D = 52A; R_G = 3.8\Omega$		3		mJ
E_{off}	Turn-off Switching Energy			1.5		
E_{on}	Turn-on Switching Energy	Inductive switching @ 125°C $V_{GS} = 10V; V_{Bus} = 600V$ $I_D = 52A; R_G = 3.8\Omega$		4.2		mJ
E_{off}	Turn-off Switching Energy			1.7		

Chopper diode ratings and characteristics

Symbol	Characteristic	Test Conditions	Min	Typ	Max	Unit
V_{RRM}	Maximum Peak Repetitive Reverse Voltage		1000			V
I_{RM}	Maximum Reverse Leakage Current	$V_R = 1000V$	$T_j = 25^\circ\text{C}$		100	μA
			$T_j = 125^\circ\text{C}$		500	
I_F	DC Forward Current	$T_c = 80^\circ\text{C}$		60		A
V_F	Diode Forward Voltage	$I_F = 60A$		2.2	2.8	V
		$I_F = 120A$		2.8		
		$I_F = 60A$ $T_j = 125^\circ\text{C}$		1.8		
t_{rr}	Reverse Recovery Time	$I_F = 60A$ $V_R = 667V$ $di/dt = 200A/\mu\text{s}$	$T_j = 25^\circ\text{C}$		235	ns
			$T_j = 125^\circ\text{C}$		305	
Q_{rr}	Reverse Recovery Charge	$I_F = 60A$ $V_R = 667V$ $di/dt = 200A/\mu\text{s}$	$T_j = 25^\circ\text{C}$		460	nC
			$T_j = 125^\circ\text{C}$		2600	

Thermal and package characteristics

Symbol	Characteristic	Min	Typ	Max	Unit	
R _{thJC}	Junction to Case Thermal Resistance	CoolMOS		0.27	°C/W	
		diode		0.9		
V _{ISOL}	RMS Isolation Voltage, any terminal to case t=1 min, I _{isol} <1mA, 50/60Hz	4000			V	
T _J	Operating junction temperature range	-40		150	°C	
T _{STG}	Storage Temperature Range	-40		125		
T _C	Operating Case Temperature	-40		100		
Torque	Mounting torque	To heatsink	M4	2.5	4.7	N.m
Wt	Package Weight				80	g

Temperature sensor NTC (see application note APT0406 on www.microsemi.com for more information).

Symbol	Characteristic	Min	Typ	Max	Unit
R ₂₅	Resistance @ 25°C		50		kΩ
ΔR ₂₅ /R ₂₅			5		%
B _{25/85}	T ₂₅ = 298.15 K		3952		K
ΔB/B	T _C = 100°C		4		%

$$R_T = \frac{R_{25}}{\exp\left[B_{25/85}\left(\frac{1}{T_{25}} - \frac{1}{T}\right)\right]}$$

T: Thermistor temperature
 R_T: Thermistor value at T

SP1 Package outline (dimensions in mm)

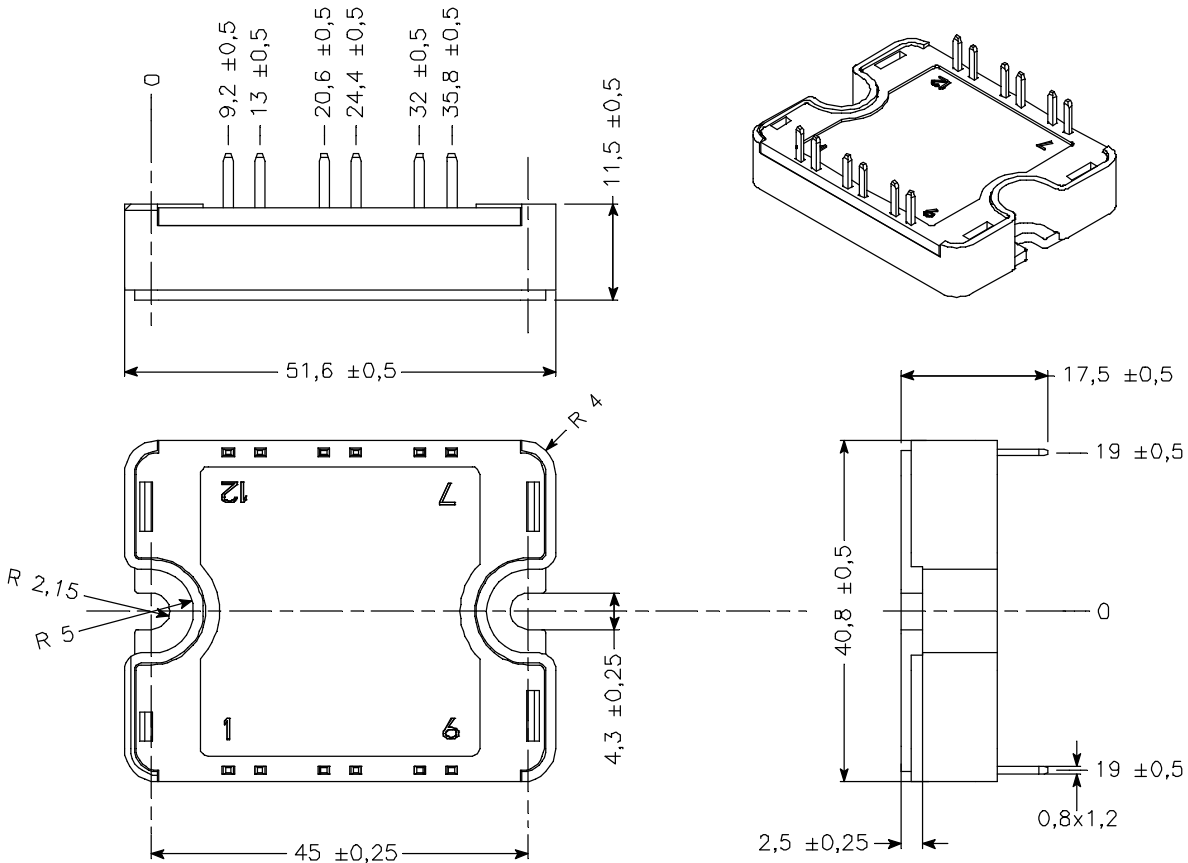

See application note 1904 - Mounting Instructions for SP1 Power Modules on www.microsemi.com

Typical CoolMOS Performance Curve

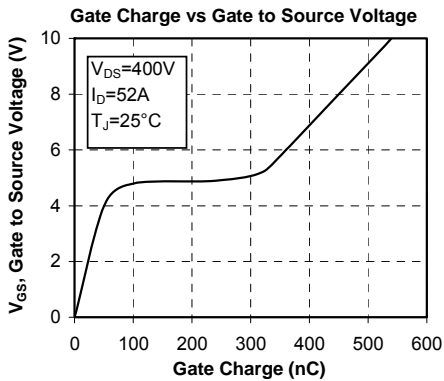
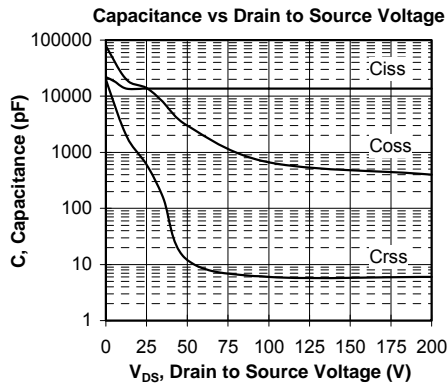
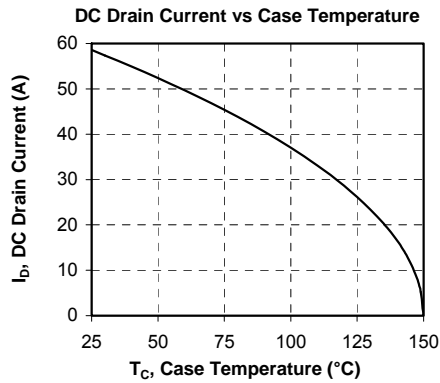
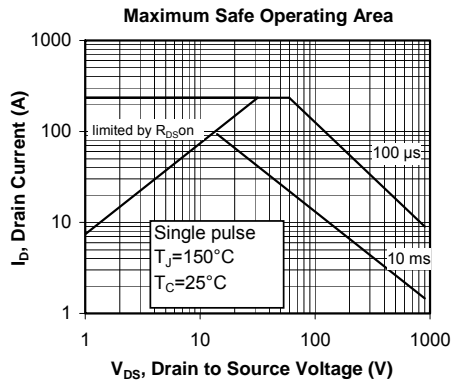
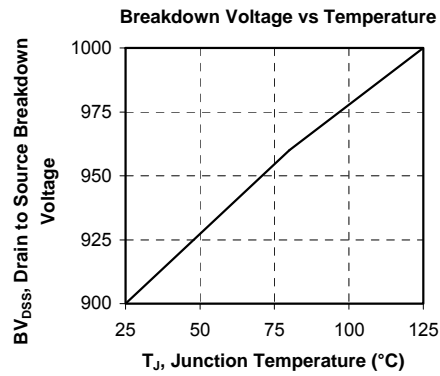
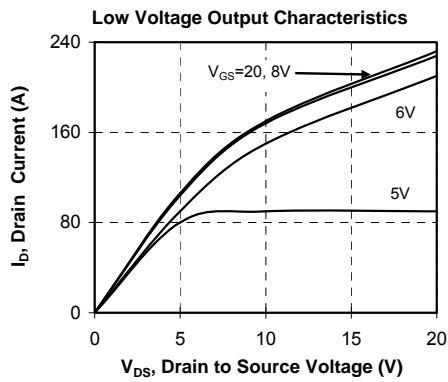
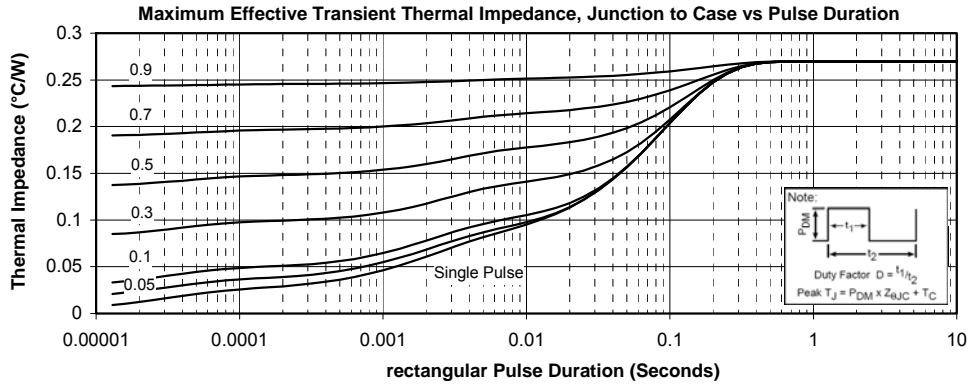

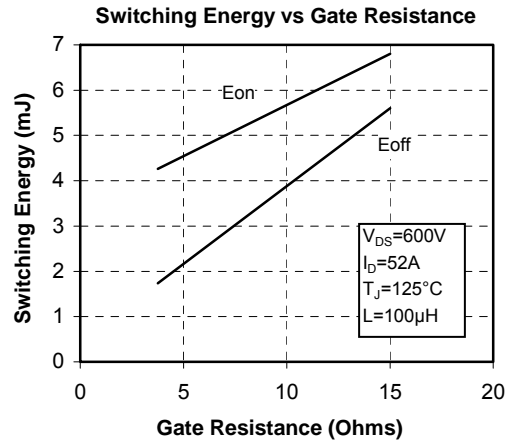
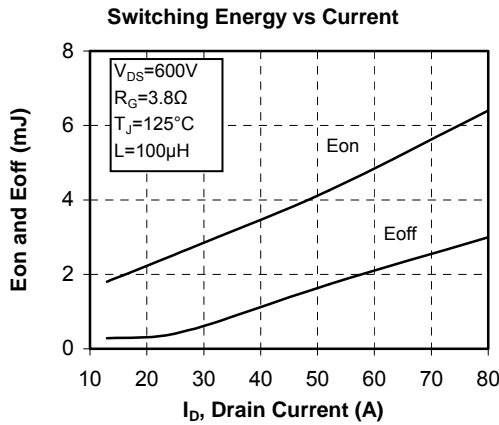
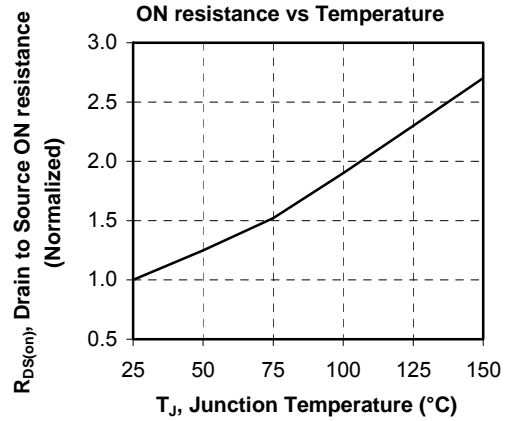
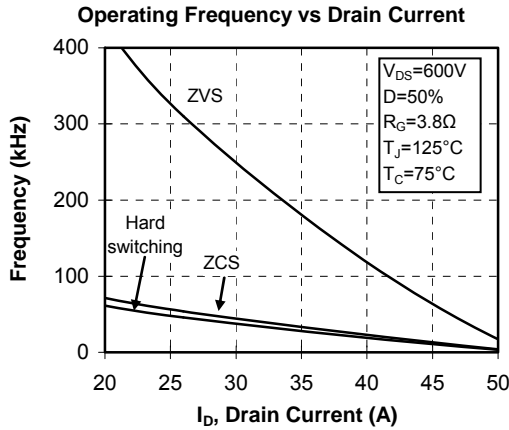

“COOLMOS™ comprise a new family of transistors developed by Infineon Technologies AG. “COOLMOS” is a trademark of Infineon Technologies AG”.

Microsemi reserves the right to change, without notice, the specifications and information contained herein

Microsemi's products are covered by one or more of U.S. patents 4,895,810 5,045,903 5,089,434 5,182,234 5,019,522 5,262,336 6,503,786 5,256,583 4,748,103 5,283,202 5,231,474 5,434,095 5,528,058 6,939,743 7,352,045 5,283,201 5,801,417 5,648,283 7,196,634 6,664,594 7,157,886 6,939,743 7,342,262 and foreign patents. U.S and Foreign patents pending. All Rights Reserved.