

**OBSOLETE PRODUCT**

Contact Factory for Replacement Model

**Single Output  
USQ 20A Models**

**High-Density, Quarter-Brick  
20 Amp, DC/DC Converters**

**Features**

- Standard, 1.45" x 2.28" x 0.40" quarter-brick package and pinout
- Outstanding thermal-derating
- Output current: to 20 Amps
- Outputs Voltages:  
1.2/1.5/1.8/2.5/3.3/5/12/15/18/24V
- Input voltage ranges:  
36-75V (48V nom.)  
18-36V (24V nom.)
- Synchronous rectification yields high efficiency (to 91%) and stable no-load operation
- On/Off control, trim and sense functions
- Fully isolated, 1500Vdc guaranteed
- Fully I/O protected; Thermal shutdown
- UL1950/EN60950 (BASIC insulation) approvals
- Qual tested; HALT tested; EMI compliant

For low-voltage, high-current power . . . in the smallest space . . . over the widest temperature range . . . call on DATEL's USQ Series 20 Amp "quarter bricks." Occupying the industry-standard package (1.45" x 2.28" x 0.40") and pinout, USQ's house their fully-synchronous, forward design topology in a "two-board" assembly crowned with a heat-sink-compatible aluminum baseplate. This combination of outstanding thermal and electrical efficiencies endows USQ's with industry-leading, thermal-derating performance. The 1.8V<sub>OUT</sub> model, for example, delivers its full 20 Amps up to +55°C with a mere 200 lfm air flow.

USQ's achieve all the performance metrics required for contemporary, on-board power processing: high isolation (1500Vdc), superior efficiency (to 91%), tight regulation (to ±0.05% max. line and load), low noise (to 50mVp-p), quick step response (200µsec), and an array of protection features. I/O protection includes input under-voltage lockout and reverse-polarity protection, as well as output overvoltage protection, current limiting, short-circuit protection, and thermal shutdown. The USQ functionality suite includes remote on/off control (positive or negative polarity), output trim (+10/-20%), and output sense functions.

All USQ DC/DC's are designed to meet the BASIC insulation requirements of UL1950 and EN60950, and all 48 Volt models will carry the CE mark. Safety certifications, as well as EMC compliance testing and qualification testing (including HALT) have been successfully completed. Contact DATEL for copies of the latest reports.

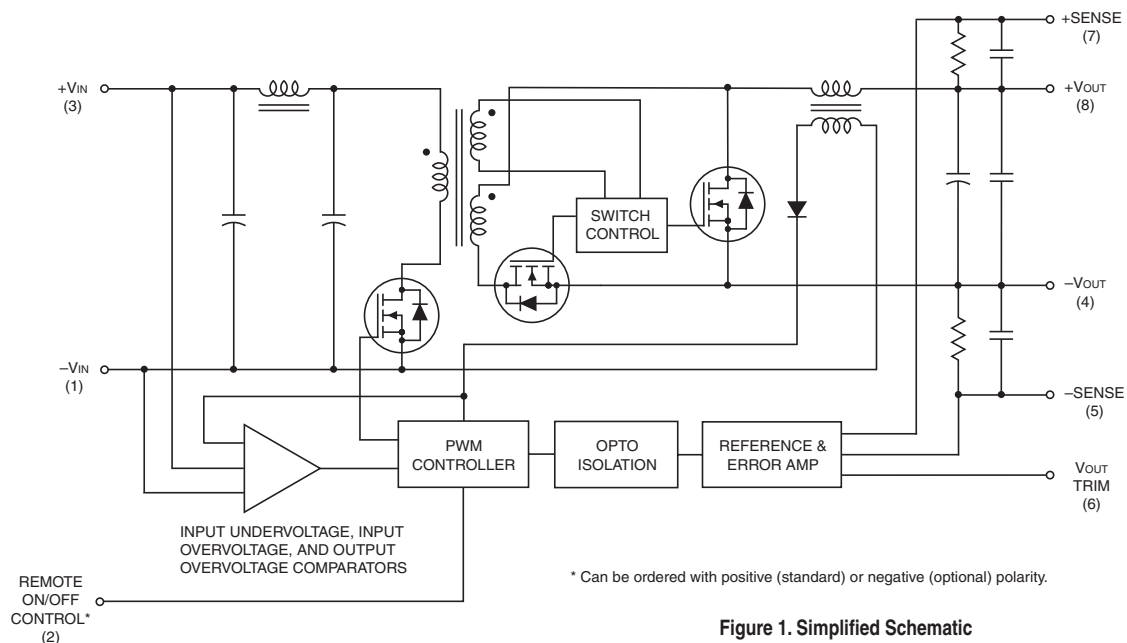

**Performance Specifications and Ordering Guide** ①

Model	Output					Input				Package (Case, Pinout)	
	V <sub>OUT</sub> ② (Volts)	I <sub>OUT</sub> (Amps)	R/N (mVp-p) ③		Regulation (Max.)		V <sub>IN</sub> Nom. (Volts) ⑤	Range (Volts) ⑤	I <sub>IN</sub> ⑥ (Amps)		Efficiency
			Typ.	Max.	Line	Load ④					
USQ-1.2/20-D48	1.2	20	25	50	±0.05%	±0.05%	48	36-75	0.63/0.87	80%	C33, P32
USQ-1.5/20-D48	1.5	20	40	65	±0.05%	±0.05%	48	36-75	0.75/1.03	85%	C33, P32
USQ-1.8/20-D48	1.8	20	60	80	±0.05%	±0.05%	48	36-75	0.88/1.23	85%	C33, P32
USQ-2.5/20-D48	2.5	20	60	75	±0.05%	±0.05%	48	36-75	1.18/1.62	87%	C33, P32
USQ-3.3/20-D48	3.3	20	70	85	±0.05%	±0.05%	48	36-75	1.54/2.1	89%	C33, P32
USQ-5/20-D24	5	20	40	65	±0.05%	±0.05%	48	36-75	5.07/6.21	90%	C33, P32
USQ-5/20-D48	5	20	40	65	±0.05%	±0.05%	48	36-75	2.33/3.13	90%	C33, P32
USQ-6.5/16-D24 ⑦	6.5	16	90	125	±0.05%	±0.05%	24	18-36	4.95/6.60	87.5%	C33, P32
USQ-12/8.3-D24 ⑧	12	8.3	120	140	±0.05%	±0.05%	48	36-75	4.61/6.08	90%	C33, P32
USQ-12/8.3-D48 ⑧	12	8.3	120	140	±0.05%	±0.05%	48	36-75	2.30/2.41	90%	C33, P32
USQ-15/6.7-D24	15	6.7	140	155	±0.05%	±0.05%	24	18-36	4.65/6.14	91%	C33, P32
USQ-15/6.7-D48	15	6.7	145	175	±0.05%	±0.05%	48	36-75	2.30/2.42	91%	C33, P32
USQ-18/5.6-D24	18	5.6	145	175	±0.05%	±0.05%	24	18-36	5.05/6.17	91%	C33, P32
USQ-18/5.6-D48	18	5.6	145	175	±0.05%	±0.05%	48	36-75	2.30/2.42	91%	C33, P32
USQ-24/4.2-D24	24	4.2	115	130	±0.05%	±0.05%	24	18-36	5.05/6.17	92%	C33, P32
USQ-24/4.2-D48	24	4.2	115	130	±0.05%	±0.05%	48	36-75	2.27/3.18	92%	C33, P32
USQ-48/2.1-D48 ⑦	48	2.1	115	200	±0.01%	±0.01%	48	36-75	2.27/3.03	94.5%	C33, P32

OBSOLETE PRODUCT

Contact Factory for Replacement Model

- ① Typical at T<sub>A</sub> = +25°C under nominal line voltage and full-load conditions, unless otherwise noted. All models are tested and specified with external output capacitors (1µF ceramic in parallel with 10µF tantalum).
- ② Contact DATEL for fixed output voltages (such as 2, 6.5, -5.2V) or higher output currents (such as 12V @ 12.5A) other than those listed.
- ③ Ripple/Noise (R/N) is tested/specified over a 20MHz bandwidth. Output noise may be further reduced with the installation of additional external output filtering. See I/O Filtering, Input Ripple Current, and Output Noise for details.
- ④ The load-regulation specs apply over the 0-100% range. All models in the USQ Series have no minimum-load requirements and will regulate within spec under no-load conditions (with perhaps a slight increase in ripple/noise). Additionally, 1.2V, 1.5V, 1.8V, 2.5V and 5V models are unconditionally stable, including start-up and short-circuit-shutdown situations, with capacitive loads up to 25,000µF. The 12V, 15V, 18V and 24V models are unconditionally stable with capacitive loads up to 470µF at full load.
- ⑤ Contact DATEL for V<sub>IN</sub> ranges other than those listed.
- ⑥ The two listed dc currents are for the following conditions: full load/nominal input voltage and full load/low line voltage. The latter is usually the worst-case condition for input current.
- ⑦ Contact DATEL for availability and further information on these models.
- ⑧ These models are discontinued. Refer to DATEL's ULQ and UVQ series for alternate models.

**PART NUMBER STRUCTURE**

USQ-3.3/20-D48ND

**Output Configuration:**  
U = Unipolar/Single

**Quarter-Brick Package**

**Nominal Output Voltage:**  
1.2/1.5/1.8/2.5/3.3/5/12/15/18/24 Volts

**Maximum Rated Output Current in Amps**

**Negative Trim:**  
Contact DATEL

**Remote On/Off Control Polarity:**  
Add "P" for positive polarity (pin 2 open = converter on)  
Add "N" for negative polarity (pin 2 open = converter off)

**Input Voltage Range:**  
D48 = 36-75 Volts (48V nominal)  
D24 = 18-36 Volts (24V nominal)

**MECHANICAL SPECIFICATIONS**

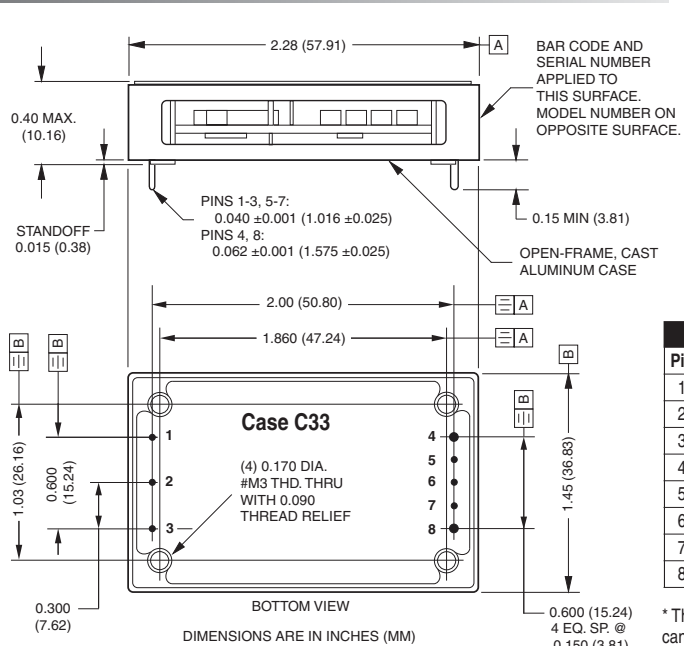

**Optional Heat Sink**

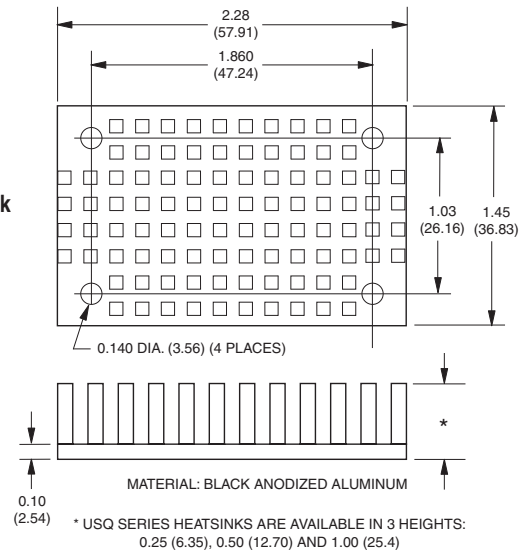

I/O Connections	
Pin	Function P32
1	-Input
2	Remote On/Off*
3	+Input
4	-Output
5	-Sense
6	Output Trim
7	+Sense
8	+Output

\* The Remote On/Off can be provided with either positive (standard) or negative (optional) polarity.

**Heat Sink Ordering Information**

Heat Sink Height	DATEL Part Number
0.25 inches (6.35mm)	HS-QB25
0.50 inches (12.70mm)	HS-QB50
1.00 inches (25.40mm)	HS-QB100

All heat sinks include 4 mounting screws and a thermal pad. If using heatsinks other than DATEL's HS-QB series, the screw length should accommodate the 0.090 thread relief.

- ① DATEL conforms to industry-standard quarter-brick pinout (see Figure 20).
- ② A "baseplate only" model with a maximum height of 0.375" (9.53mm) is available with the addition of an "H" suffix. Contact DATEL.

## Performance/Functional Specifications

Typical @ T<sub>A</sub> = +25°C under nominal line voltage and full-load conditions, unless noted. <sup>(1)</sup>

Input	
<b>Input Voltage Range:</b>	
D24 Models	18-36 Volts (24V nominal)
D48 Models	36-75 Volts (48V nominal)
<b>Overvoltage Shutdown</b>	None <sup>(3)</sup>
<b>Start-Up Threshold:</b> <sup>(4)</sup>	
D24 Models	15.5-18 Volts (16.5V typical)
D48 Models	28.5-32 Volts (30V typical)
<b>Undervoltage Shutdown:</b> <sup>(4)</sup>	
D24 Models	14.5-16.5 Volts (15.5V typical)
D48 Models	26.5-29.5 Volts (28.3V typical)
<b>Input Current:</b>	
Normal Operating Conditions	See Ordering Guide
Inrush Transient	0.05A <sup>2</sup> sec maximum
Standby Mode:	
Off, UV, Thermal Shutdown	3mA
<b>Input Reflected Ripple Current</b> <sup>(5)</sup>	5mA <sub>p-p</sub>
<b>Internal Input Filter Type:</b>	
D24 Models	Pi (0.01μF - 1.5μH - 3.3μF)
D48 Models	Pi (0.01μF - 4.7μH - 3.3μF)
<b>Reverse-Polarity Protection</b> <sup>(3)</sup>	1 minute duration, 5A maximum
<b>Remote On/Off Control</b> (Pin 2): <sup>(6)</sup>	
Positive Logic ("P" Suffix Models)	On = open, open collector or 2.5-5V applied. I <sub>IN</sub> = 150μA max. Off = pulled low to 0-0.8V I <sub>IN</sub> = 800μA max.
Negative Logic ("N" Suffix Models)	On = pulled low to 0-0.8V I <sub>IN</sub> = 800μA max. Off = open, open collector or 2.5-5V applied. I <sub>IN</sub> = 150μA max.
Output	
<b>Minimum Loading</b>	No load
<b>Maximum Capacitive Loading</b> <sup>(7)</sup>	25,000μF
<b>V<sub>OUT</sub> Accuracy</b> (Full Load):	
Initial	±1% maximum
Temperature Coefficient	±0.02% per °C
Extreme <sup>(8)</sup>	±3%
<b>V<sub>OUT</sub> Trim Range</b> <sup>(9)</sup>	+10%, -20%
<b>Remote Sense Compensation</b> <sup>(4)</sup>	+10%
<b>Ripple/Noise</b> (20MHz BW)	See Ordering Guide
<b>Line/Load Regulation</b>	See Ordering Guide
<b>Efficiency</b>	See Ordering Guide
<b>Isolation Voltage:</b>	
Input-to-Output	1500Vdc minimum
Input-to-Case	1500Vdc minimum
Output-to-Case	1500Vdc minimum
<b>Isolation Resistance</b>	100MΩ
<b>Isolation Capacitance</b>	650pF
<b>Current Limit Inception</b> (90% V <sub>OUT</sub> ) <sup>(10)</sup>	
1.2V <sub>OUT</sub>	22-30 Amps (26A typical)
1.5, 1.8, 2.5, 3.3, 5V <sub>OUT</sub>	22-29 Amps (26A typical)
12V <sub>OUT</sub>	9.2-10.5 Amps (9.9A typical)
15V <sub>OUT</sub>	7.6-8.9 Amps (8.25A typical)
18V <sub>OUT</sub>	6-7.75 Amps (6.5A typical)
24V <sub>OUT</sub>	4.8-6 Amps (5.5A typical)
<b>Short Circuit:</b> <sup>(4)</sup>	
Current	Hiccup
Duration	Continuous

Output (Continued)	
<b>Overvoltage Protection:</b> <sup>(4)</sup>	Magnetic feedback
1.5V <sub>OUT</sub>	2.2 Volts
1.8V <sub>OUT</sub>	2.7 Volts
2.5V <sub>OUT</sub>	3.8 Volts
3.3V <sub>OUT</sub>	4.9 Volts
5V <sub>OUT</sub>	6.4 Volts
12V <sub>OUT</sub>	15 Volts
15V <sub>OUT</sub>	20 Volts
18V <sub>OUT</sub>	22.5 Volts
24V <sub>OUT</sub>	30 Volts
Dynamic Characteristics	
<b>Dynamic Load Response</b> <sup>(11)</sup>	See Dynamic Load Response under Technical Notes
<b>Start-Up Time:</b> <sup>(4) (12)</sup>	
V <sub>IN</sub> to V <sub>OUT</sub>	5msec typical, 8msec maximum
On/Off to V <sub>OUT</sub>	5msec typical, 8msec maximum
<b>Switching Frequency</b>	<sup>(11)</sup>
Environmental	
<b>Calculated MTBF:</b> <sup>(13)</sup>	>2.5 million hours
<b>Operating Temperature</b> (Ambient): <sup>(4) (14)</sup>	
Without Derating	Model and air flow dependent
With Derating	To +110°C (baseplate)
<b>Baseplate Temperature:</b> <sup>(4) (14)</sup>	
Maximum Allowable	+110°C
Thermal Shutdown	+115-122°C, +118°C typical.
Physical	
<b>Dimensions</b>	1.45" x 2.28" x 0.40" (36.8 x 57.9 x 10.2mm)
<b>Case Material</b>	Cast aluminum
<b>Baseplate Material</b>	Aluminum
<b>Shielding</b>	Neither the aluminum case nor baseplate are connected to a package pin
<b>Pin Material</b>	Brass, solder coated
<b>Weight:</b>	1.52 ounces (43 grams)
<b>Primary-to-Secondary Insulation Level</b>	Basic

- <sup>(1)</sup> All models are tested and specified with external output capacitors (1μF ceramic in parallel with 10μF tantalum), unless otherwise noted. These converters have no minimum-load requirements and will effectively regulate under no-load conditions.
- <sup>(2)</sup> Contact DATEL for input voltage ranges (18-36V, 24V nominal) other than those listed.
- <sup>(3)</sup> See Absolute Maximum Ratings for allowable input voltages.
- <sup>(4)</sup> See Technical Notes/Performance Curves for additional explanations and details.
- <sup>(5)</sup> Input Ripple Current is tested/specified over a 5-20MHz bandwidth with an external 33μF input capacitor and a simulated source impedance of 220μF and 12μH. See I/O Filtering, Input Ripple Current and Output Noise for details. The 24V input models can benefit by increasing the 33μF external input capacitance to 100μF, if the application has a high source impedance.
- <sup>(6)</sup> The On/Off Control is designed to be driven with open-collector (or equivalent) logic or the application of appropriate voltages (referenced to -Input (pin 1)). See Remote On/Off Control for more details.
- <sup>(7)</sup> USQ Series DC/DC converters are unconditionally stable, including start-up and short-circuit-shutdown situations, with capacitive loads up to 25,000μF (470μF for 12V, 15V, 18V and 24V models at full load).
- <sup>(8)</sup> Extreme Accuracy refers to the accuracy of either trimmed or untrimmed output voltages over all normal operating ranges and combinations of input voltage, output load and temperature.
- <sup>(9)</sup> See Output Trimming for detailed trim equations.
- <sup>(10)</sup> The Current-Limit Inception point is the output current level at which the USQ's power-limiting circuitry drops the output voltage 10% from its initial value. See Output Current Limiting and Short-Circuit Protection for more details.
- <sup>(11)</sup> See Dynamic Load Response under Technical Notes for detailed results including switching frequencies. DATEL has performed extensive evaluations of Dynamic Load Response. In addition to the 10μF || 1μF external capacitors, specifications are also given for 220μF || 1μF external output capacitors for quick comparison purposes.
- <sup>(12)</sup> For the Start-Up Time specifications, output settling is defined by the output voltage having reached ±1% of its final value.
- <sup>(13)</sup> MTBF's are calculated using Telcordia (Bellcore) Method 1 Case 3, ground fixed conditions, +40°C case temperature, and full-load conditions. Contact DATEL for demonstrated life-test data.
- <sup>(14)</sup> All models are fully operational and meet published specifications, including "cold start," at -40°C.

**Absolute Maximum Ratings**

Input Voltage:	24V models	48V models
Continuous:	39 Volts	81 Volts
Transient (100msec)	50 Volts	100 Volts
<b>Input Reverse-Polarity Protection</b>	Input Current must be <5A. 1 minute duration. Fusing recommended.	
<b>Output Current</b>	Current limited. Devices can withstand an indefinite output short circuit.	
<b>On/Off Control (Pin 2) Max. Voltages</b>	Referenced to -Input (pin 1)	
	-0.3 to +7 Volts	
<b>Storage Temperature</b>	-40 to +125°C	
<b>Lead Temperature (Soldering, 10 sec.)</b>	+300°C	

These are stress ratings. Exposure of devices to any of these conditions may adversely affect long-term reliability. Proper operation under conditions other than those listed in the Performance/Functional Specifications Table is not implied, nor recommended.

**TECHNICAL NOTES**

**Removal of Soldered USQ's from PCB's**

Should removal of the USQ from its soldered connection be needed, it is very important to thoroughly de-solder the pins using solder wicks or de-soldering tools. At no time should any prying or leverage be used to remove boards that have not been properly de-soldered first.

**Input Source Impedance**

USQ converters must be driven from a low ac-impedance input source. The DC/DC's performance and stability can be compromised by the use of highly inductive source impedances. The input circuit shown in Figure 2 is a practical solution that can be used to minimize the effects of inductance in the input traces. For optimum performance, components should be mounted close to the DC/DC converter. The 24V models can benefit by increasing the 33µF external input capacitors to 100µF, if the application has a high source impedance.

**I/O Filtering, Input Ripple Current, and Output Noise**

All models in the USQ Series are tested/specified for input ripple current (also called input reflected ripple current) and output noise using the circuits and layout shown in Figures 2 and 3.

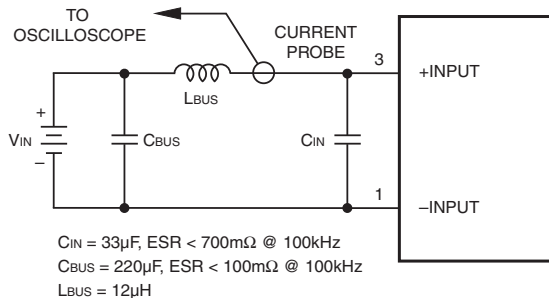

**Figure 2. Measuring Input Ripple Current**

External input capacitors ( $C_{IN}$  in Figure 2) serve primarily as energy-storage elements. They should be selected for bulk capacitance (at appropriate frequencies), low ESR, and high rms-ripple-current ratings. The switching nature of DC/DC converters requires that dc voltage sources have low ac

impedance as highly inductive source impedance can affect system stability. In Figure 2,  $C_{BUS}$  and  $L_{BUS}$  simulate a typical dc voltage bus. Your specific system configuration may necessitate additional considerations.

In critical applications, output ripple/noise (also referred to as periodic and random deviations or PARD) can be reduced below specified limits using filtering techniques, the simplest of which is the installation of additional external output capacitors. Output capacitors function as true filter elements and should be selected for bulk capacitance, low ESR, and appropriate frequency response. In Figure 3, the two copper strips simulate real-world pcb impedances between the power supply and its load. Scope measurements should be made using BNC connectors or the probe ground should be less than ½ inch and soldered directly to the fixture.

All external capacitors should have appropriate voltage ratings and be located as close to the converter as possible. Temperature variations for all relevant parameters should be taken into consideration. OS-CON™ organic semiconductor capacitors (www.sanyo.com) can be especially effective for further reduction of ripple/noise.

The most effective combination of external I/O capacitors will be a function of line voltage and source impedance, as well as particular load and layout conditions. Our Applications Engineers can recommend potential solutions and discuss the possibility of our modifying a given device's internal filtering to meet your specific requirements. Contact our Applications Engineering Group for additional details.

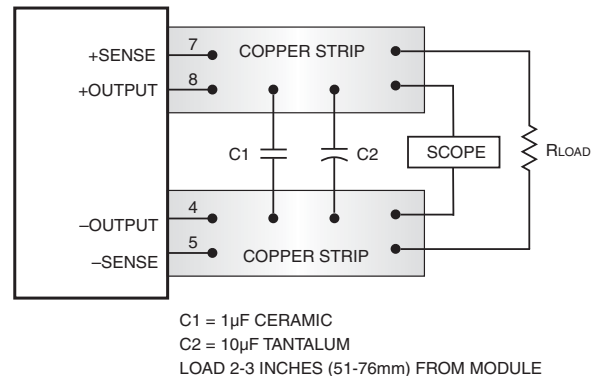

**Figure 3. Measuring Output Ripple/Noise (PARD)**

**Input Overvoltage Shutdown**

Standard USQ DC/DC converters do not feature overvoltage shutdown. They are equipped with this function, however. Many of our customers need their devices to withstand brief input surges to 100V without shutting down. Consequently, we disabled the function. Please contact us if you would like it enabled, at any voltage, for your application.

**Start-Up Threshold and Undervoltage Shutdown**

Under normal start-up conditions, the USQ Series will not begin to regulate properly until the ramping input voltage exceeds the Start-Up Threshold. Once operating, devices will turn off when the applied voltage drops below the Undervoltage Shutdown point. Devices will remain off as long as the undervoltage condition continues. Units will automatically re-start when the applied voltage is brought back above the Start-Up Threshold. The hysteresis built into this function avoids an indeterminate on/off condition at a single input voltage. See Performance/Functional Specifications table for actual limits.



### Start-Up Time

The  $V_{IN}$  to  $V_{OUT}$  Start-Up Time is the interval between the point at which a ramping input voltage crosses the Start-Up Threshold voltage and the point at which the fully loaded output voltage enters and remains within its specified  $\pm 1\%$  accuracy band. Actual measured times will vary with input source impedance, external input capacitance, and the slew rate and final value of the input voltage as it appears to the converter. The On/Off to  $V_{OUT}$  Start-Up Time assumes the converter is turned off via the Remote On/Off Control with the nominal input voltage already applied. The specification defines the interval between the point at which the converter is turned on (released) and the point at which the fully loaded output voltage enters and remains within its specified  $\pm 1\%$  accuracy band.

### On/Off Control

The primary-side, Remote On/Off Control function (pin 2) can be specified to operate with either positive or negative polarity. Positive-polarity devices ("P" suffix) are enabled when pin 2 is left open or is pulled high (+2.5-5V applied with respect to -Input, pin 1,  $I_{IN} < 150\mu A$  typical). Positive-polarity devices are disabled when pin 2 is pulled low (0-0.8V with respect to -Input,  $I_{IN} < 800\mu A$ ). Negative-polarity devices are off when pin 2 is high/open and on when pin 2 is pulled low. See Figure 4.

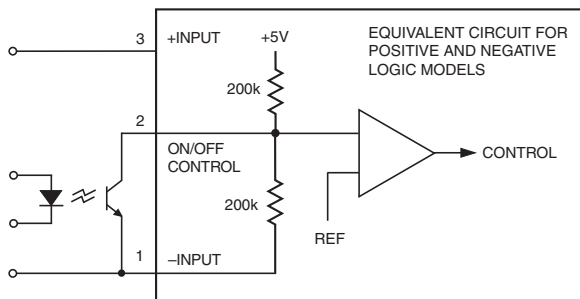

Figure 4. Driving the Remote On/Off Control Pin

Dynamic control of the remote on/off function is best accomplished with a mechanical relay or an open-collector/open-drain drive circuit (optically isolated if appropriate). The drive circuit should be able to sink appropriate current (see Performance Specifications) when activated and withstand appropriate voltage when deactivated.

### Current Limiting

When power demands from the output falls within the current limit inception range for the rated output current, the DC/DC converter will go into a current limiting mode. In this condition the output voltage will decrease proportionately with increases in output current, thereby maintaining a somewhat constant power dissipation. This is commonly referred to as power limiting. Current limit inception is defined as the point where the full-power output voltage falls below the specified tolerance. If the load current being drawn from the converter is significant enough, the unit will go into a short circuit condition. See "Short Circuit Condition."

### Short Circuit Condition

When a converter is in current limit mode the output voltages will drop as the output current demand increases. If the output voltage drops too low, the magnetically coupled voltage used to develop primary side voltages will also drop, thereby shutting down the PWM controller. Following a time-out period

of 5 to 15 milliseconds, the PWM will restart, causing the output voltages to begin ramping to their appropriate values. If the short-circuit condition persists, another shutdown cycle will be initiated. This on/off cycling is referred to as "hiccup" mode. The hiccup cycling reduces the average output current, thereby preventing internal temperatures from rising to excessive levels. The USQ is capable of enduring an indefinite short circuit output condition.

### Thermal Shutdown

USQ converters are equipped with thermal-shutdown circuitry. If the internal temperature of the DC/DC converter rises above the designed operating temperature (See Performance Specifications), a precision temperature sensor will power down the unit. When the internal temperature decreases below the threshold of the temperature sensor, the unit will self start.

### Output Overvoltage Protection

The output voltage is monitored for an overvoltage condition via magnetic coupling to the primary side. If the output voltage rises to a fault condition, which could be damaging to the load circuitry (see Performance Specifications), the sensing circuitry will power down the PWM controller causing the output voltage to decrease. Following a time-out period the PWM will restart, causing the output voltage to ramp to its appropriate value. If the fault condition persists, and the output voltages again climb to excessive levels, the overvoltage circuitry will initiate another shutdown cycle. This on/off cycling is referred to as "hiccup" mode.

### Input Reverse-Polarity Protection

If the input-voltage polarity is accidentally reversed, an internal diode will become forward biased and likely draw excessive current from the power source. If the source is not current limited ( $< 5A$ ) nor the circuit appropriately fused, it could cause permanent damage to the converter.

### Input Fusing

Certain applications and/or safety agencies may require the installation of fuses at the inputs of power conversion components. Fuses should also be used if the possibility of a sustained, non-current-limited, input-voltage polarity reversal exists. For DATEL USQ Series DC/DC Converters, slow-blow fuses are recommended with values no greater than the following:

$V_{OUT}$ Range	Fuse Value -D48	Fuse Value -D24
1.2 $V_{OUT}$ Models	1.5 Amps	—
1.5 $V_{OUT}$ Models	2.5 Amps	—
1.8 $V_{OUT}$ Models	3 Amps	—
2.5 $V_{OUT}$ Models	3.5 Amps	—
3.3 $V_{OUT}$ Models	4 Amps	—
5 to 24 $V_{OUT}$ Models	6 Amps	10 Amps

See Performance Specifications for Input Current and Inrush Transient limits.

### Trimming Output Voltage

USQ converters have a trim capability (pin 6) that enables users to adjust the output voltage from +10% to -20% (refer to the trim equations and trim graphs that follow). Adjustments to the output voltage can be accomplished with a single fixed resistor as shown in Figures 5 and 6. A single fixed resistor can increase or decrease the output voltage depending on its connection. Resistors should be located close to the converter and have TCR's less than 100ppm/ $^{\circ}C$  to minimize sensitivity to changes in temperature. If the trim function is not used, leave the trim pin open.

Standard USQ's have a "positive trim" where a single resistor connected from the Trim pin (pin 6) to the +Sense (pin 7) will increase the output voltage. A resistor connected from the Trim Pin (pin 6) to the -Sense (pin 5) will decrease the output voltage. DATEL also offers a "negative trim" function (D suffix added to the part number). Contact DATEL for information on negative trim devices.

Trim adjustments greater than the specified +10%/–20% can have an adverse affect on the converter's performance and are not recommended. Excessive voltage differences between  $V_{OUT}$  and Sense, in conjunction with trim adjustment of the output voltage, can cause the overvoltage protection circuitry to activate (see Performance Specifications for overvoltage limits).

Temperature/power derating is based on maximum output current and voltage at the converter's output pins. Use of the trim and sense functions can cause output voltages to increase, thereby increasing output power beyond the USQ's specified rating, or cause output voltages to climb into the output overvoltage region. Therefore:

$$(V_{OUT \text{ at pins}}) \times (I_{OUT}) \leq \text{rated output power}$$

The Trim pin (pin 6) is a relatively high impedance node that can be susceptible to noise pickup when connected to long conductors in noisy environments. In such cases, a 0.22 $\mu$ F capacitor can be added to reduce this long lead effect.

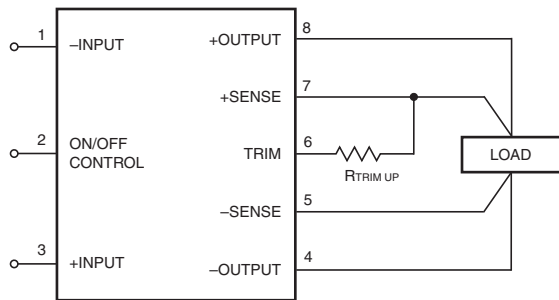

**Figure 5. Trim Connections To Increase Output Voltages Using Fixed Resistors**

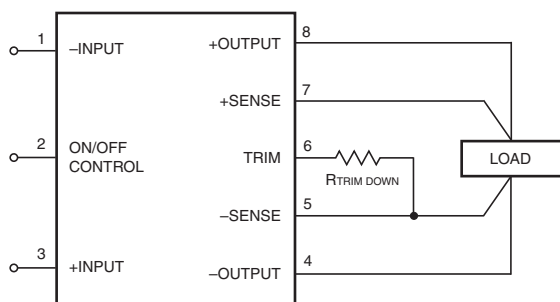

**Figure 6. Trim Connections To Decrease Output Voltages Using Fixed Resistors**

**Trim Equations**

<b>USQ-1.2/20-D48</b>	
$R_{TUP} (k\Omega) = \frac{1.308(V_O - 0.793)}{V_O - 1.2} - 1.413$	$R_{TDOWN} (k\Omega) = \frac{1.037}{1.2 - V_O} - 1.413$
<b>USQ-1.5/20-D48</b>	
$R_{TUP} (k\Omega) = \frac{6.23(V_O - 1.226)}{V_O - 1.5} - 10.2$	$R_{TDOWN} (k\Omega) = \frac{7.64}{1.5 - V_O} - 10.2$
<b>USQ-1.8/20-D48</b>	
$R_{TUP} (k\Omega) = \frac{7.44(V_O - 1.226)}{V_O - 1.8} - 10.2$	$R_{TDOWN} (k\Omega) = \frac{9.12}{1.8 - V_O} - 10.2$
<b>USQ-2.5/20-D48</b>	
$R_{TUP} (k\Omega) = \frac{10(V_O - 1.226)}{V_O - 2.5} - 10.2$	$R_{TDOWN} (k\Omega) = \frac{12.26}{2.5 - V_O} - 10.2$
<b>USQ-3.3/20-D48</b>	
$R_{TUP} (k\Omega) = \frac{13.3(V_O - 1.226)}{V_O - 3.3} - 10.2$	$R_{TDOWN} (k\Omega) = \frac{16.31}{3.3 - V_O} - 10.2$
<b>USQ-5/20-D24, -D48</b>	
$R_{TUP} (k\Omega) = \frac{20.4(V_O - 1.226)}{V_O - 5} - 10.2$	$R_{TDOWN} (k\Omega) = \frac{25.01}{5 - V_O} - 10.2$
<b>USQ-12/8.3-D24, -D48</b>	
$R_{TUP} (k\Omega) = \frac{49.6(V_O - 1.226)}{V_O - 12} - 10.2$	$R_{TDOWN} (k\Omega) = \frac{60.45}{12 - V_O} - 10.2$
<b>USQ-15/6.7-D24, -D48</b>	
$R_{TUP} (k\Omega) = \frac{62.9(V_O - 1.226)}{V_O - 15} - 10.2$	$R_{TDOWN} (k\Omega) = \frac{76.56}{15 - V_O} - 10.2$
<b>USQ-18/5.6-D24, -D48</b>	
$R_{TUP} (k\Omega) = \frac{75.5(V_O - 1.226)}{V_O - 18} - 10.2$	$R_{TDOWN} (k\Omega) = \frac{92.9}{18 - V_O} - 10.2$
<b>USQ-24/4.2-D24, -D48</b>	
$R_{TUP} (k\Omega) = \frac{101(V_O - 1.226)}{V_O - 24} - 10.2$	$R_{TDOWN} (k\Omega) = \frac{124.2}{24 - V_O} - 10.2$

Note: Resistor values are in k $\Omega$ . Adjustment accuracy is subject to resistor tolerances and factory-adjusted output accuracy.  $V_O$  = desired output voltage.

Trim-Up Resistance vs. Percentage Increase in Output Voltage

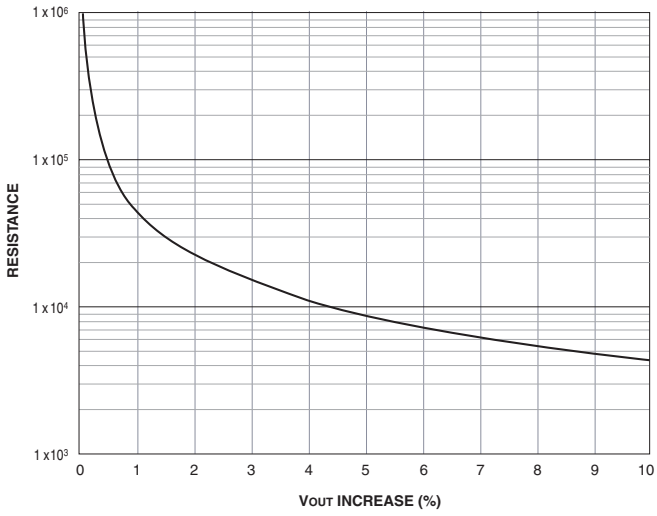

Figure 7. USQ-1.2 Trim-Up Resistance vs. % Increase Vout

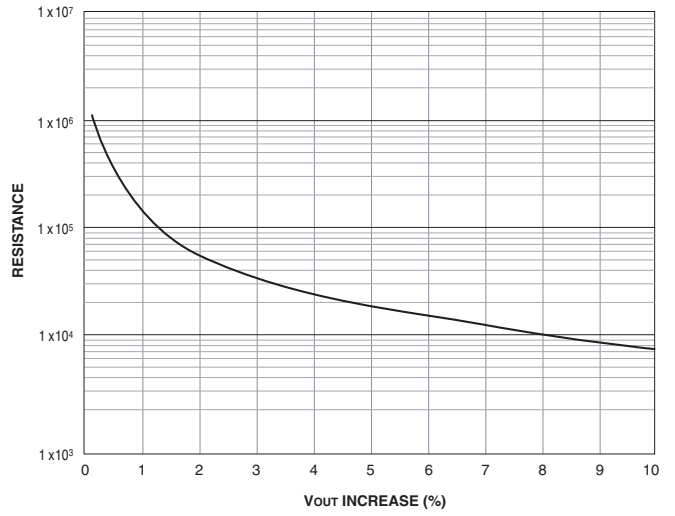

Figure 8. USQ-1.5 Trim-Up Resistance vs. % Increase Vout

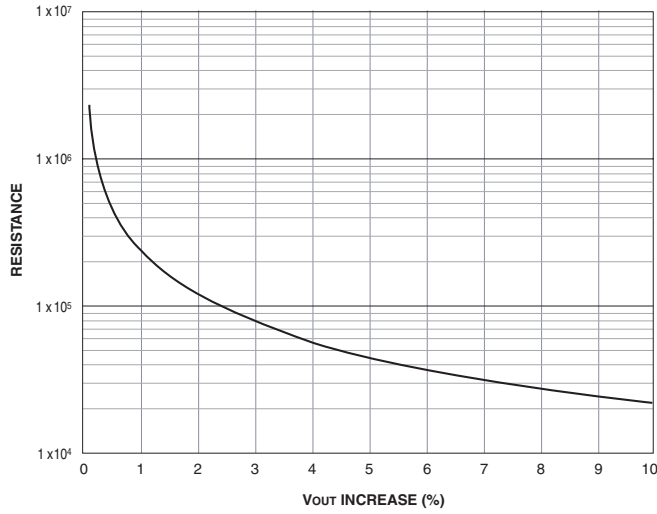

Figure 9. USQ-1.8 Trim-Up Resistance vs. % Increase Vout

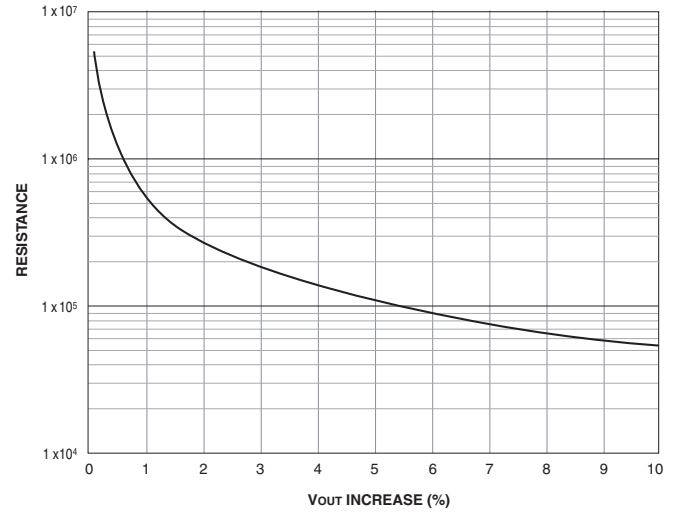

Figure 10. USQ-2.5 Trim-Up Resistance vs. % Increase Vout

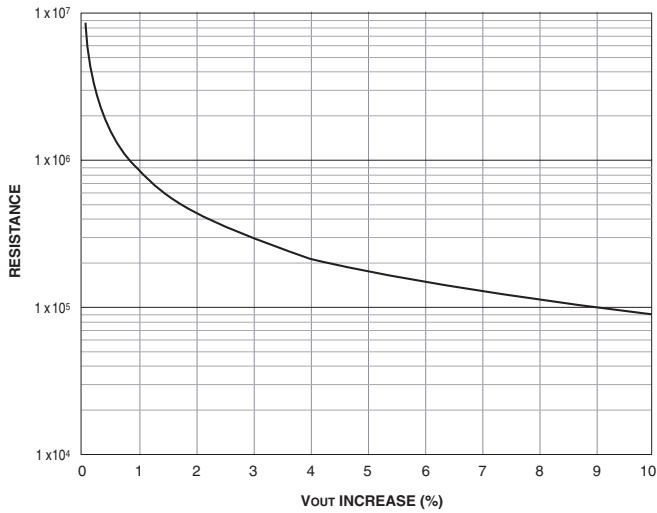

Figure 11. USQ-3.3 Trim-Up Resistance vs. % Increase Vout

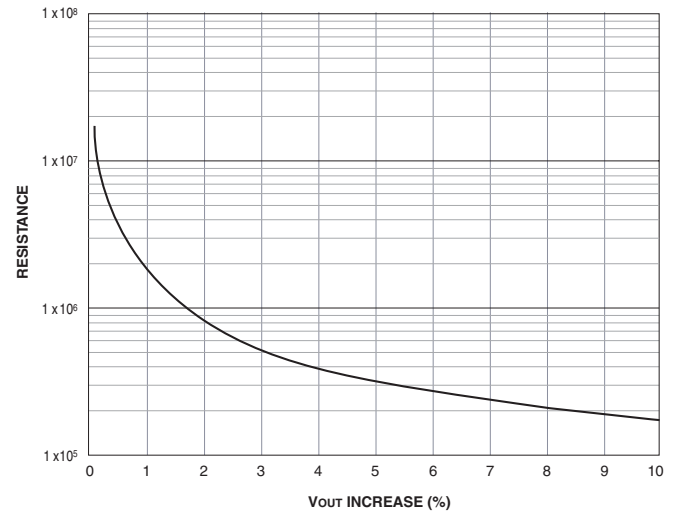

Figure 12. USQ-5 Trim-Up Resistance vs. % Increase Vout

**Trim-Up Resistance vs. Percentage Increase in Output Voltage**

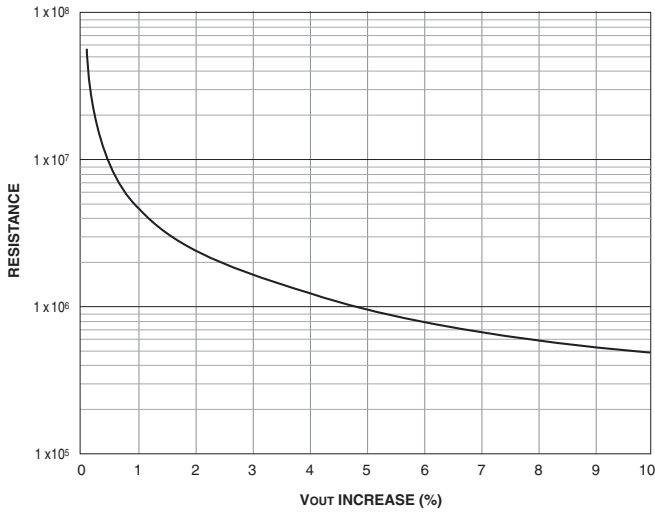

Figure 13. USQ-12 Trim-Up Resistance vs. % Increase Vout

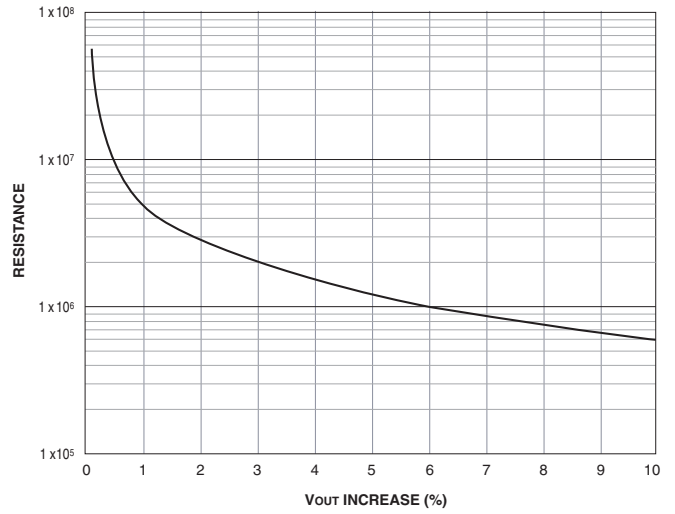

Figure 14. USQ-15 Trim-Up Resistance vs. % Increase Vout

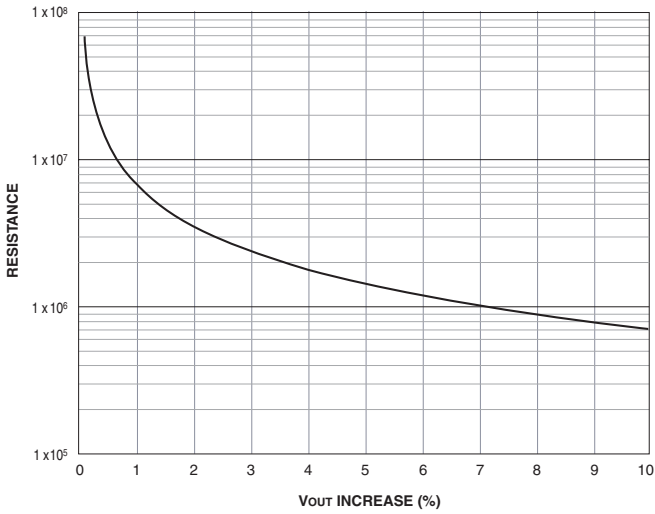

Figure 15. USQ-18 Trim-Up Resistance vs. % Increase Vout

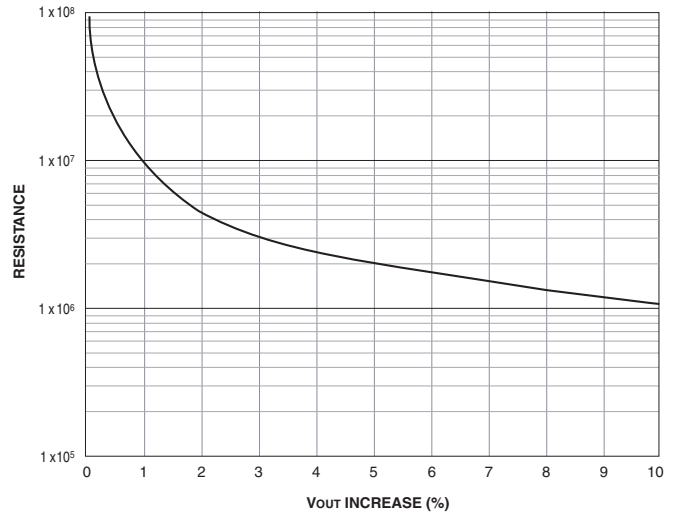

Figure 16. USQ-24 Trim-Up Resistance vs. % Increase Vout

**Trim-Down Resistance vs. Percentage Decrease in Output Voltage**

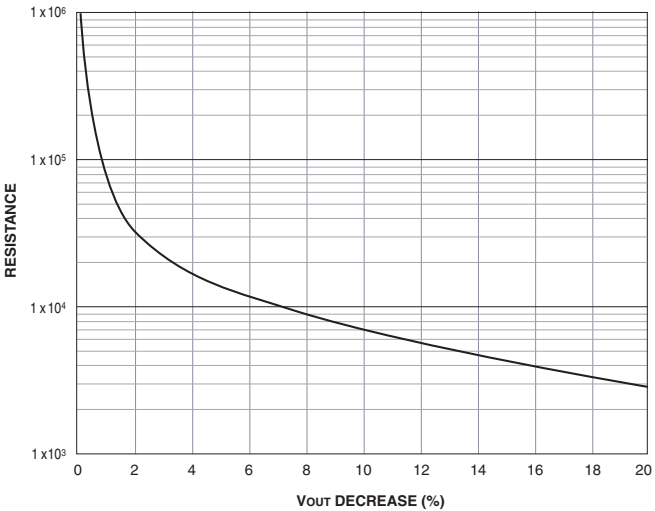

Figure 17. USQ-1.2 Trim-Down Resistance vs. % Decrease Vout

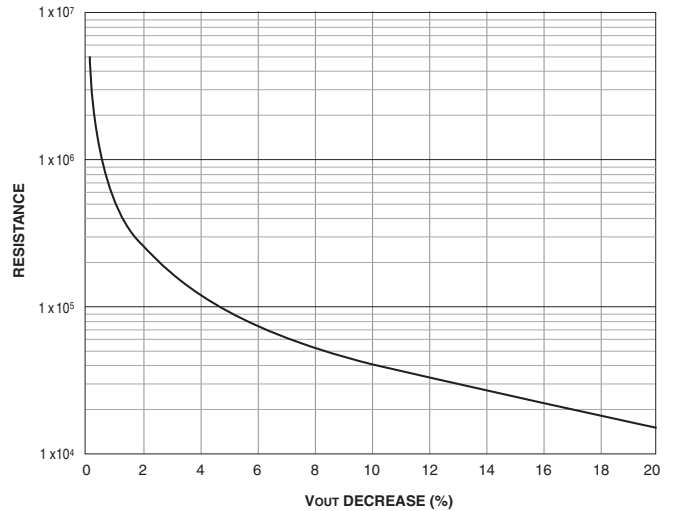

Figure 18. USQ-1.5 to USQ-18 Trim-Down Resistance vs. % Decrease Vout



**Negative-Trim Units ("D" Suffix)**

Standard USQ's have a "positive-trim" function, consistent with the industry standard footprints and functionality. DATEL also offers "negative-trim" USQ's designated with a "D" suffix to the part number. The negative-trim devices trim up with a single resistor tied from the Output Trim (pin 6) to the -Sense (pin 5) to increase the output voltage. A resistor connected from the Output Trim (pin 6) to the +Sense (pin 7) will decrease the output voltage.

The "negative-trim" formula values for USQ 1.2/1.5/1.8 Volt devices with a 48 Volt input and negative logic reads:

$$R_{TRIM} = \frac{A - Bx \Delta V}{\Delta V}$$

Model	Trim Up		Trim Down	
	A	B	A	B
USQ-1.8/20-D48ND	0.57	1	0.2711	1.4676
USQ-1.5/20-D48ND	0.283	0.121	0.065	0.352
USQ-1.2/20-D48ND	0.5928	3.01	0.5686	3.96

where ΔV is the absolute value of the output voltage change desired.

**Floating Outputs**

Since these are isolated DC/DC converters, their outputs are "floating" with respect to their input. Designers will normally use the -Output (pin 4) as the ground/return of the load circuit. You can, however, use the +Output (pin 8) as ground/return to effectively reverse the output polarity.

**Remote Sense**

Note: The Sense and V<sub>OUT</sub> lines are not internally connected to each other. Therefore, if the sense function is not used for remote regulation, the user must connect the +Sense to +V<sub>OUT</sub> and -Sense to -V<sub>OUT</sub> at the DC/DC converter pins.

USQ series converters employ a sense feature to provide point-of-use regulation, thereby overcoming moderate IR drops in pcb conductors or cabling. The remote sense lines carry very little current and therefore require a minimal cross-sectional area conductor. The sense lines, which are capacitively coupled to their respective output lines, are used by the feedback control-loop to regulate the output. As such, they are not low impedance points and must be treated with care in layouts and cabling. Sense lines on a pcb should be run adjacent to dc signals, preferably ground. In cables and discrete wiring applications, twisted pair or other techniques should be implemented.

USQ DC/DC converters will compensate for drops between the output voltage at the DC/DC and the sense voltage at the DC/DC:

$$[V_{out(+)} - V_{out(-)}] - [Sense(+) - Sense(-)] \leq 10\% V_{out}$$

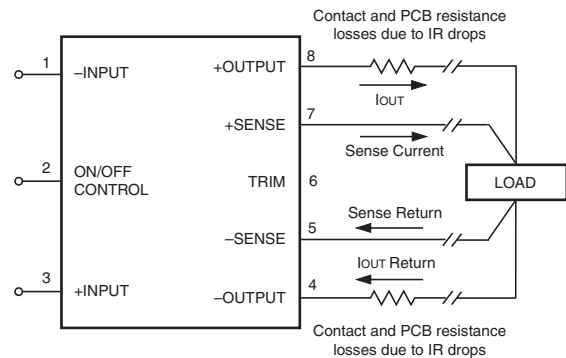

Figure 19. Remote Sense Circuit Configuration

Output overvoltage protection is monitored at the output voltage pin, not the Sense pin. Therefore, excessive voltage differences between V<sub>OUT</sub> and Sense, in conjunction with trim adjustment of the output voltage, can cause the overvoltage protection circuitry to activate (see Performance Specifications for overvoltage limits). Power derating is based on maximum output current and voltage at the converter's output pins. Use of trim and sense functions can cause output voltages to increase, thereby increasing output power beyond the USQ's specified rating, or cause output voltages to climb into the output overvoltage region. Therefore:

$$(V_{out \text{ at pins}}) \times (I_{out}) \leq \text{rated output power}$$

**Dynamic Load Response and Switching Frequency**

DATEL has performed extensive evaluations, under assorted capacitive-load conditions, of the dynamic-load capabilities (i.e., the transient or step response) of USQ Series DC/DC Converters. In particular, we have evaluated devices using the output capacitive-load conditions we use for our routine production testing (10µF tantalums in parallel with 1µF ceramics), as well as the load conditions many of our competitors use (220µF tantalums in parallel with 1µF ceramics) when specifying the dynamic performance of their devices.

To avoid the added cost of constantly changing test fixtures, we have verified, during our device characterization/verification testing, that 100% testing under the former conditions (the 100µF || 1µF load), which we guarantee, correlates extremely well with the latter conditions, for which we and most of our competitors simply list typicals.

If you have any questions about our test methods or would like us to perform additional testing under your specific load conditions, please contact our Applications Engineering Group.

Load Conditions ①	Performance Specifications	1.2V <sub>out</sub>	1.5V <sub>out</sub>	1.8V <sub>out</sub>	2.5V <sub>out</sub>	3.3V <sub>out</sub>	5V <sub>out</sub>	12 to 24V <sub>out</sub>
C <sub>OUT</sub> = 10µF    1µF 10µF    1µF	Load Step = 50 to 75% of I <sub>OUT</sub> Max.: Peak Deviation, typ. Settling Time to ±1% of Final Value, max. ②	115mV 200µs	110mV 200µs	125mV 225µs	100mV 200µs	170mV 100µs	125mV 100µs	100mV 100µs
	Load Step = 75 to 50% of I <sub>OUT</sub> Max.: Peak Deviation, typ. Settling Time to ±1% of Final Value, max. ②	115mV 140µs	110mV 200µs	125mV 225µs	100mV 200µs	100mV 100µs	125mV 100µs	100mV 100µs
C <sub>OUT</sub> = 220µF    1µF	Load Step = 50 to 75% of I <sub>OUT</sub> Max.: Peak Deviation, typ. Settling Time to ±1% of Final Value, typ. ②	120mV 115µs	TBD TBD	105mV 170µs	90mV 65µs	105mV 65µs	TBD TBD	85mV 40µs
	Load Step = 75 to 50% of I <sub>OUT</sub> Max.: Peak Deviation, typ. Settling Time to ±1% of Final Value, typ. ②	120mV 150µs	TBD TBD	90mV 150µs	90mV 70µs	105mV 65µs	TBD TBD	50mV 25µs
	Switching Frequency (min./typ./max. kHz)	120/150/180	120/150/180	170/185/200	230/255/280	132/147/162	220/240/260	190/210/230

① The listed pair of parallel output capacitors consists of a tantalum in parallel with a multi-layer ceramic.

② ΔI<sub>O</sub>/Δt = 1A/1µs, V<sub>IN</sub> = 48V, T<sub>C</sub> = 25°C.

**Typical Performance Curves for 1.2V<sub>OUT</sub> Models**

**USQ-1.2/20-D48 Efficiency vs. Line Voltage and Load Current**

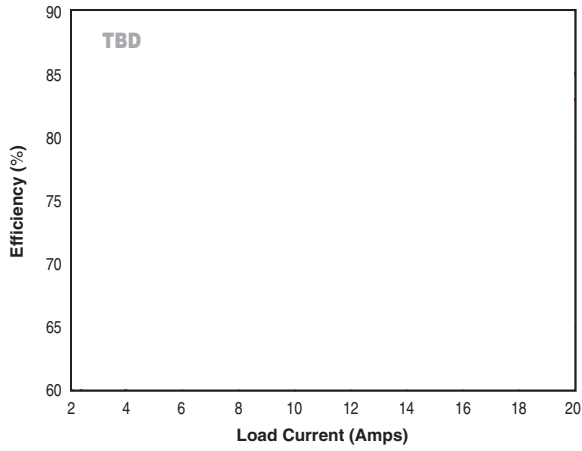

**USQ-1.2/20-D48: Maximum Output Current vs. Ambient Temperature**  
(Transverse air flow, pin 1 to pin 3; V<sub>IN</sub> = 48V, no heat sink.)

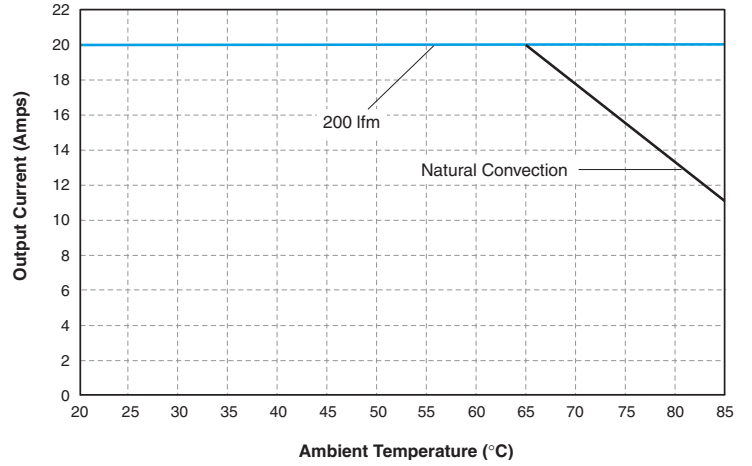

**Start-Up from V<sub>IN</sub>**  
(V<sub>IN</sub> = 48V, I<sub>OUT</sub> = 20A, C<sub>OUT</sub> = 10μF tantalum || 1μF ceramic.)

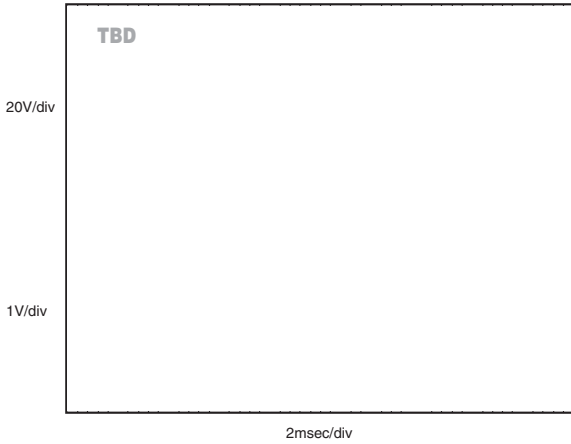

**Start-Up from Remote On/Off Control**  
(V<sub>IN</sub> = 48V, I<sub>OUT</sub> = 20A, C<sub>OUT</sub> = 10μF tantalum || 1μF ceramic.)

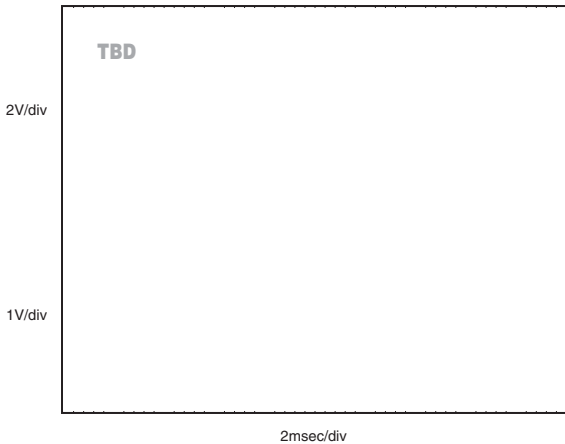

**Typical Performance Curves for 1.5V<sub>OUT</sub> Models**

**USQ-1.5/20-D48 Efficiency vs. Line Voltage/Load Current @ 25°C**

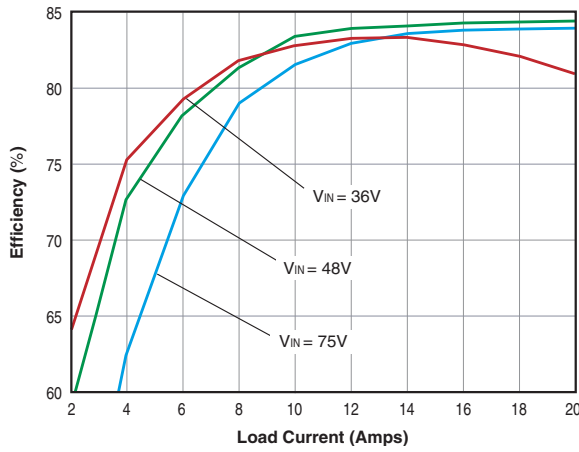

**USQ-1.5/20-D48: Maximum Output Current vs. Ambient Temperature (Transverse air flow, pin 1 to pin 3; V<sub>IN</sub> = 48V, no heat sink.)**

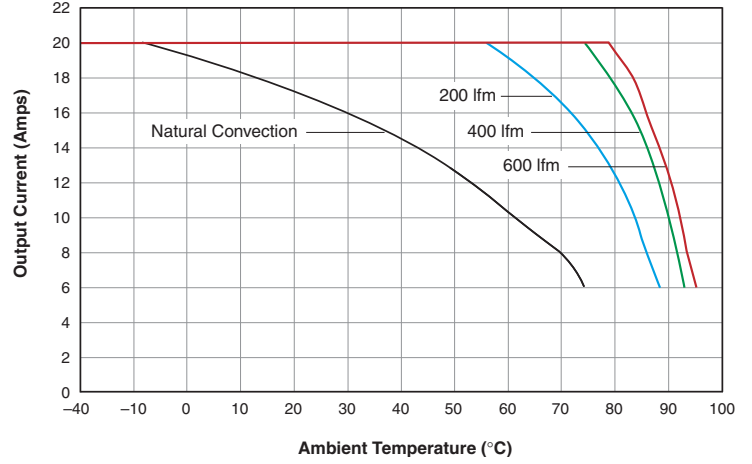

**Start-Up from V<sub>IN</sub>**  
(V<sub>IN</sub> = 48V, I<sub>OUT</sub> = 20A, C<sub>OUT</sub> = 10μF tantalum || 1μF ceramic.)

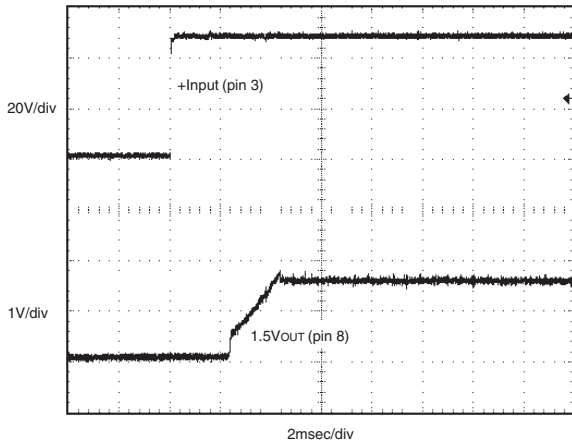

**USQ-1.5/20-D48: Maximum Output Current vs. Ambient Temperature (Longitudinal air flow, pin 1 to pin 4; V<sub>IN</sub> = 48V, no heat sink.)**

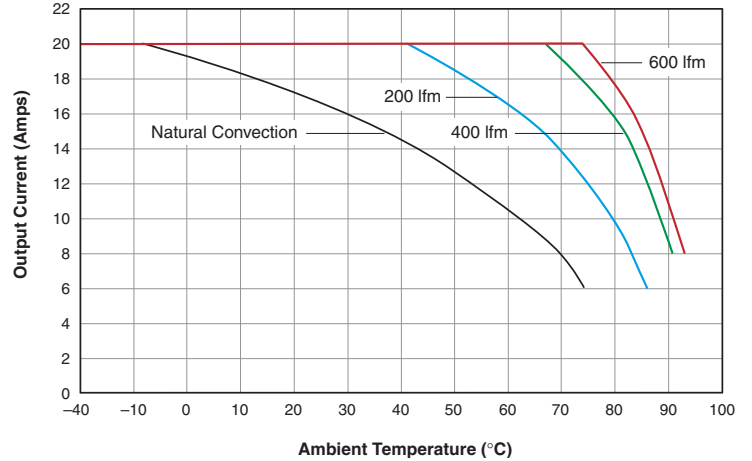

**Start-Up from Remote On/Off Control**  
(V<sub>IN</sub> = 48V, I<sub>OUT</sub> = 20A, C<sub>OUT</sub> = 10μF tantalum || 1μF ceramic.)

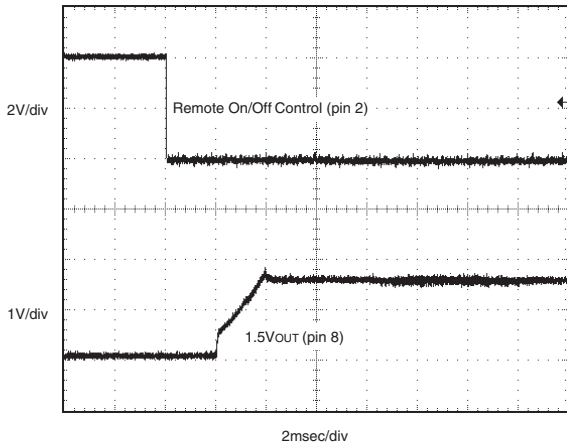

Typical Performance Curves for 1.8V<sub>OUT</sub> Models

USQ-1.8/20-D48 Efficiency vs. Line Voltage/Load Current @ 25°C

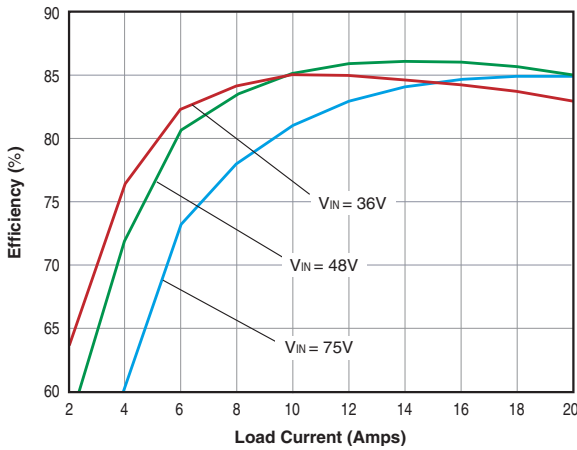

USQ-1.8/20-D48: Maximum Output Current vs. Ambient Temperature (Transverse air flow, pin 1 to pin 3; V<sub>IN</sub> = 48V, no heat sink.)

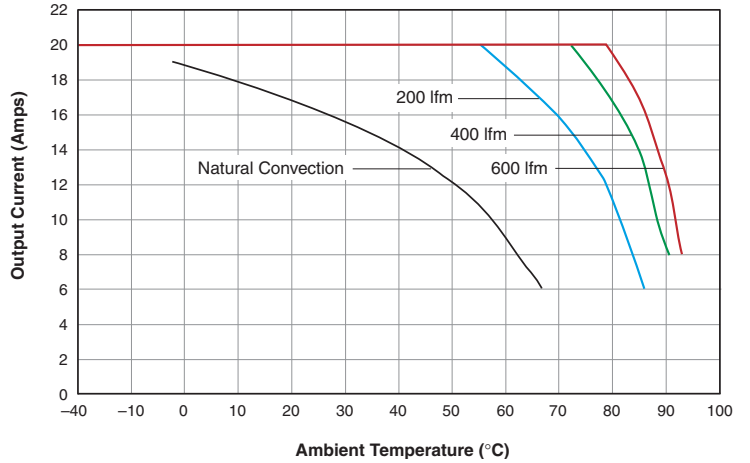

Start-Up from V<sub>IN</sub>

(V<sub>IN</sub> = 48V, I<sub>OUT</sub> = 20A, C<sub>OUT</sub> = 10μF tantalum || 1μF ceramic.)

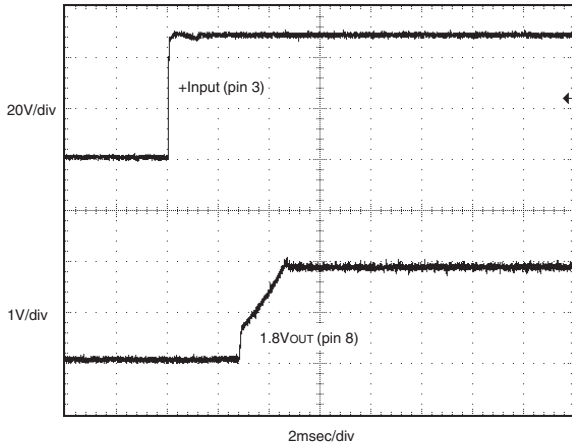

USQ-1.8/20-D48: Maximum Output Current vs. Ambient Temperature (Longitudinal air flow, pin 1 to pin 4; V<sub>IN</sub> = 48V, no heat sink.)

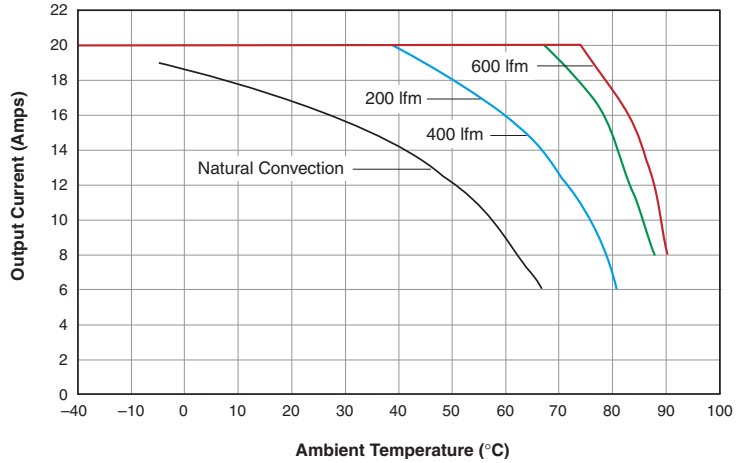

Start-Up from Remote On/Off Control

(V<sub>IN</sub> = 48V, I<sub>OUT</sub> = 20A, C<sub>OUT</sub> = 10μF tantalum || 1μF ceramic.)

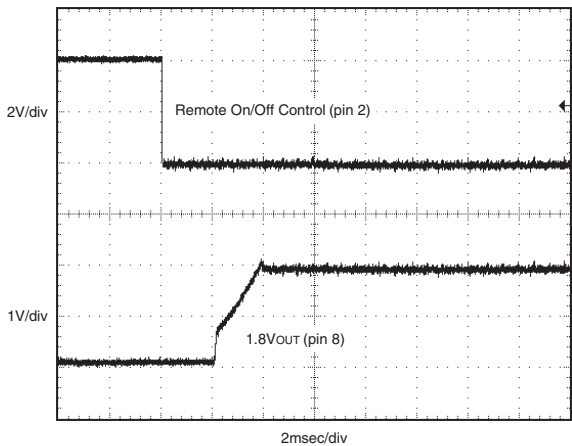

**Typical Performance Curves for 2.5V<sub>OUT</sub> Models**

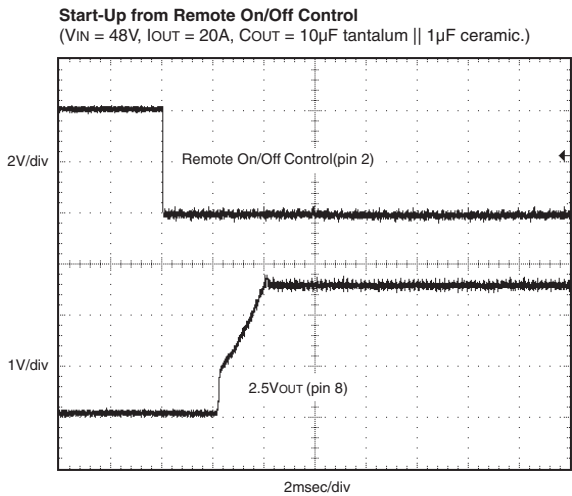
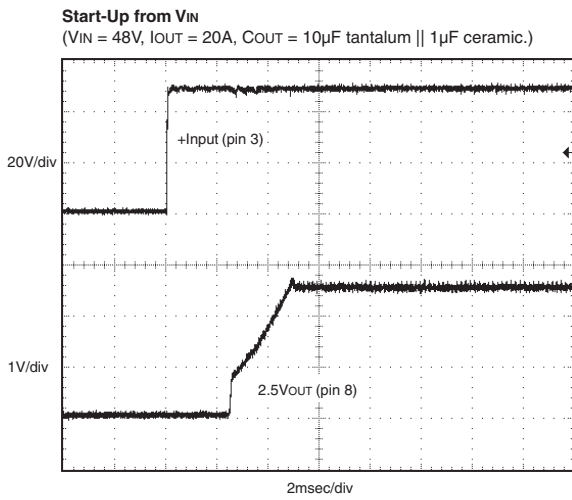
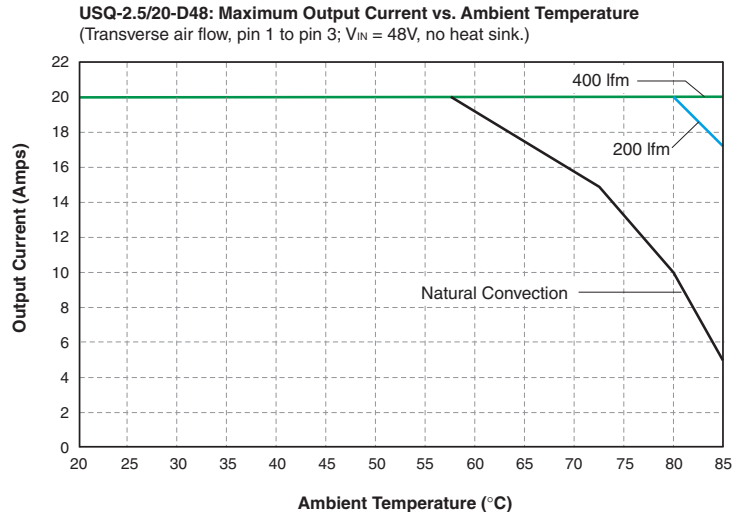
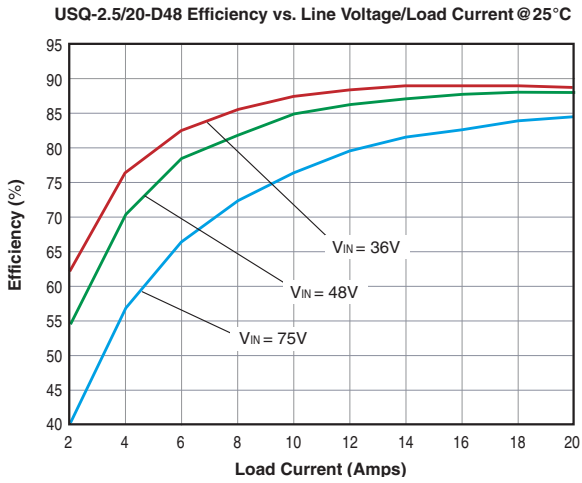



Typical Performance Curves for 3.3V<sub>OUT</sub> Models

USQ-3.3/20-D48 Efficiency vs. Line Voltage/Load Current @ 25°C

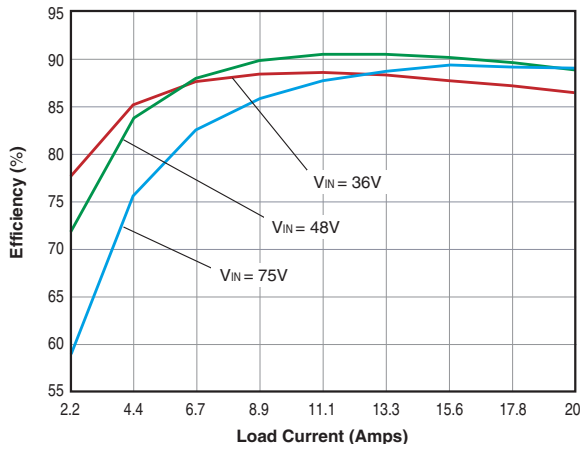

USQ-3.3/20-D48: Maximum Output Current vs. Ambient Temperature (Transverse air flow, pin 1 to pin 3; V<sub>IN</sub> = 48V, no heat sink.)

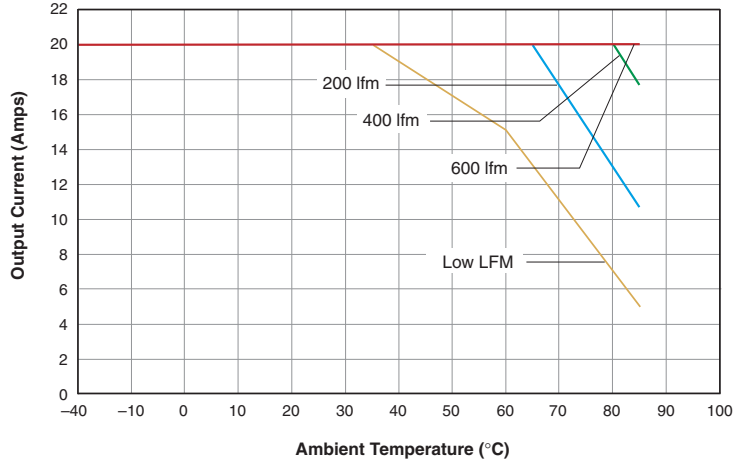

Start-Up from V<sub>IN</sub> (V<sub>IN</sub> = 48V, I<sub>OUT</sub> = 20A, C<sub>OUT</sub> = 10μF tantalum || 1μF ceramic.)

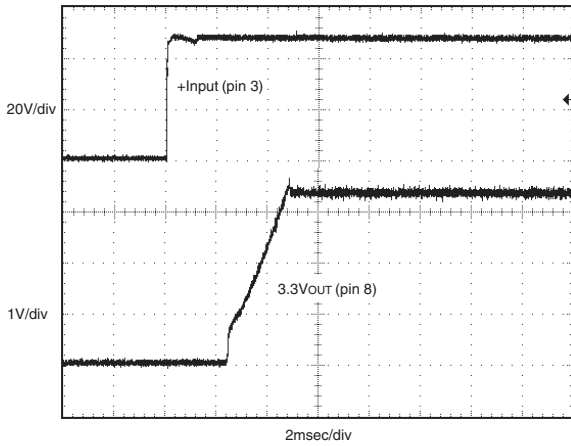

USQ-3.3/20-D48: Maximum Output Current vs. Ambient Temperature (Longitudinal air flow, pin 1 to pin 4; V<sub>IN</sub> = 48V, no heat sink.)

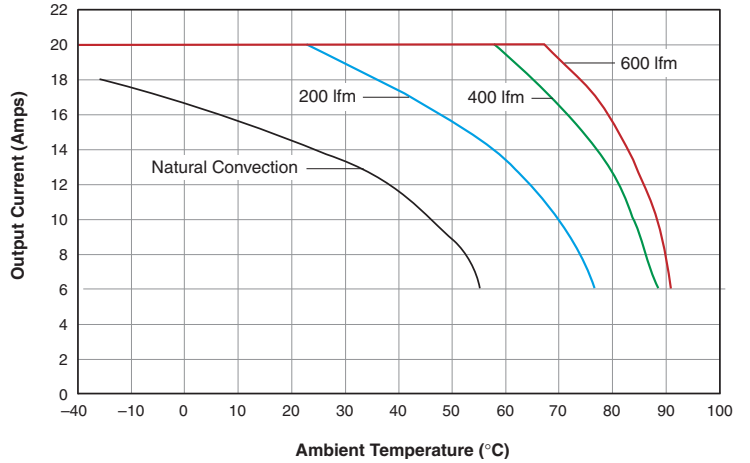

Start-Up from Remote On/Off Control (V<sub>IN</sub> = 48V, I<sub>OUT</sub> = 20A, C<sub>OUT</sub> = 10μF tantalum || 1μF ceramic.)

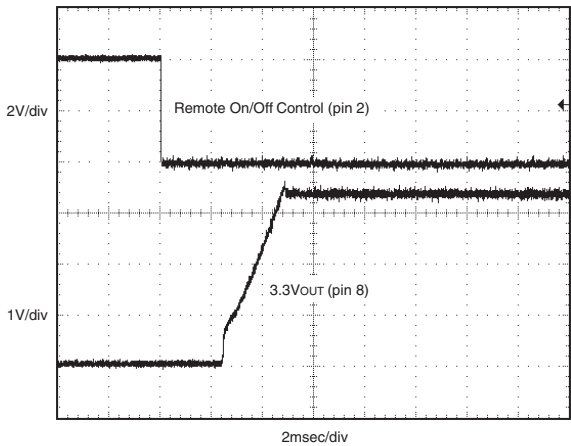

USQ-3.3/20-D48: Maximum Output Current vs. Ambient Temperature (Longitudinal air flow, pin 1 to pin 3; V<sub>IN</sub> = 48V, 1/4" heat sink.)

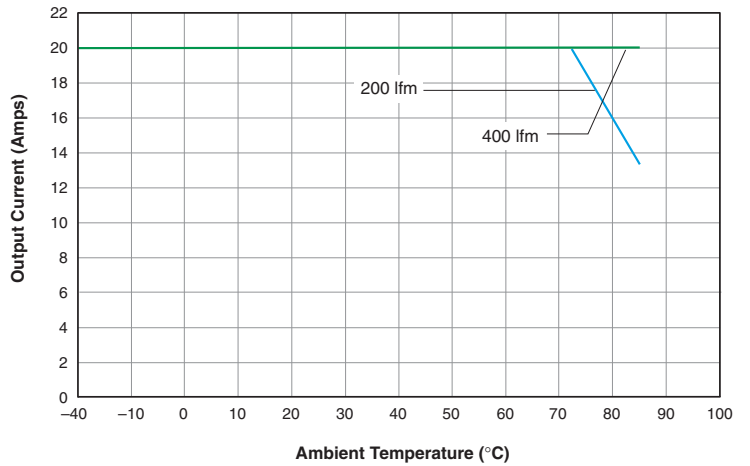

**Typical Performance Curves for 5V<sub>OUT</sub> Models**

**USQ-5/20-D48 Efficiency vs. Line Voltage/Load Current @ 25°C**

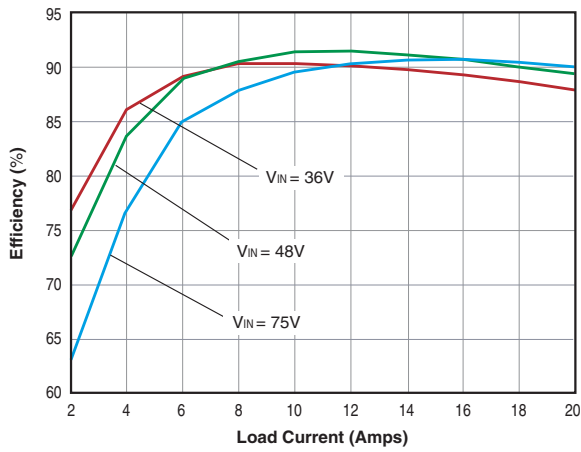

**USQ-5/20-D48: Maximum Output Current vs. Ambient Temperature (Transverse air flow, pin 1 to pin 3; VIN = 48V, no heat sink.)**

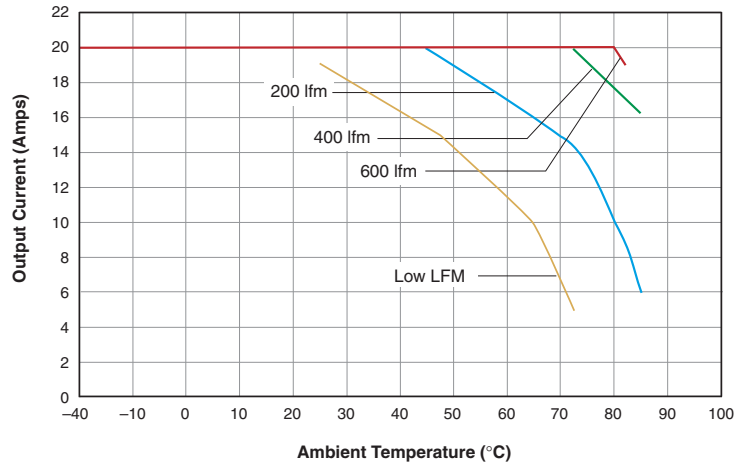

**Start-Up from VIN**  
(VIN = 48V, IOUT = 20A, COUT = 10µF tantalum || 1µF ceramic.)

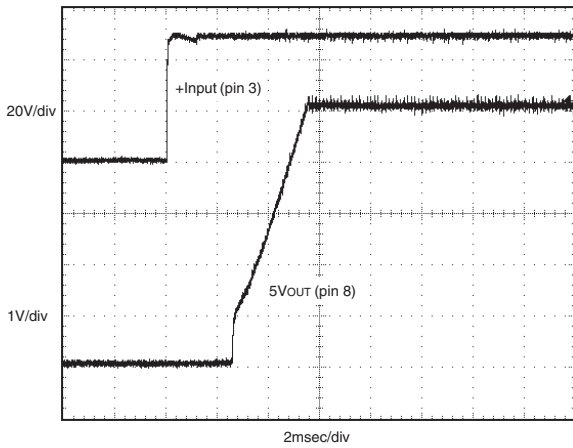

**USQ-5/20-D48: Maximum Output Current vs. Ambient Temperature (Transverse air flow, pin 1 to pin 3; VIN = 48V, 1/4" heat sink.)**

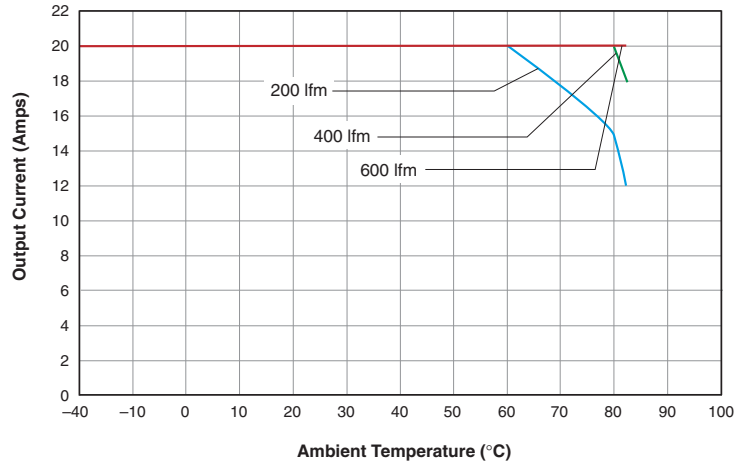

**Start-Up from Remote On/Off Control**  
(VIN = 48V, IOUT = 20A, COUT = 10µF tantalum || 1µF ceramic.)

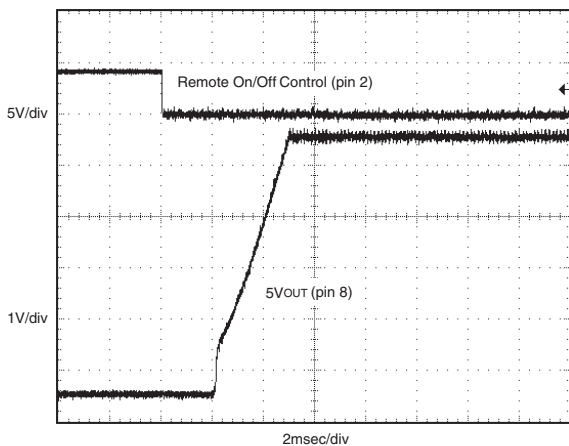

**USQ-5/20-D48: Maximum Output Current vs. Ambient Temperature (Longitudinal air flow, pin 1 to pin 4; VIN = 48V, no heat sink.)**

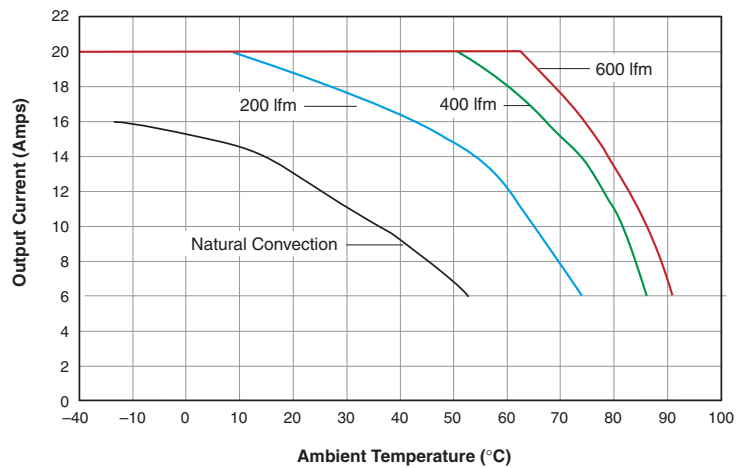

**Typical Performance Curves for 5V<sub>OUT</sub> Models**

**USQ-5/20-D48: Maximum Output Current vs. Ambient Temperature**  
 (Longitudinal air flow, pin 1 to pin 4; V<sub>IN</sub> = 48V, 1/4" heat sink.)

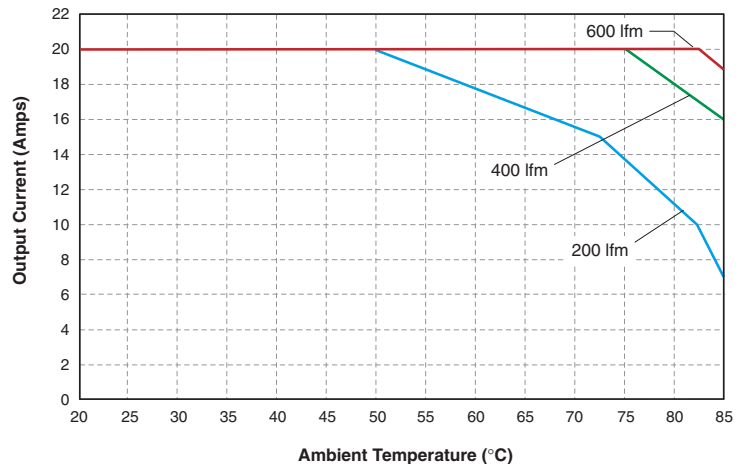

**USQ-5/20-D48: Maximum Output Current vs. Ambient Temperature**  
 (Transverse air flow, pin 1 to pin 3; V<sub>IN</sub> = 48V, 1/4" heat sink.)

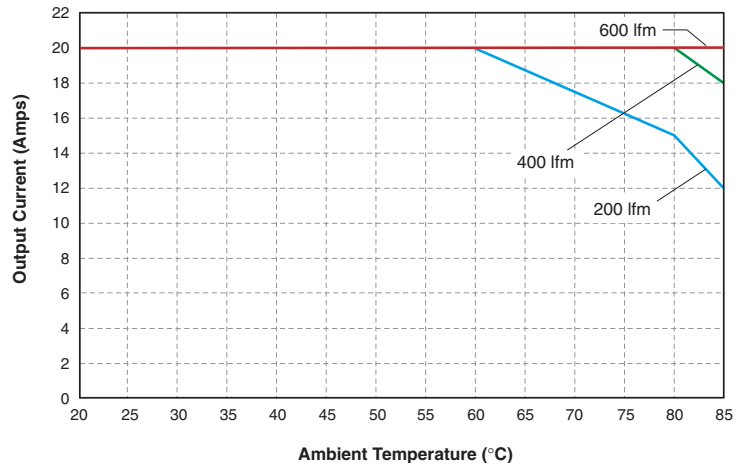

**Typical Performance Curves for 12V<sub>OUT</sub> Models**

**USQ-12/8.3-D48 Efficiency vs. Line Voltage and Load Current**

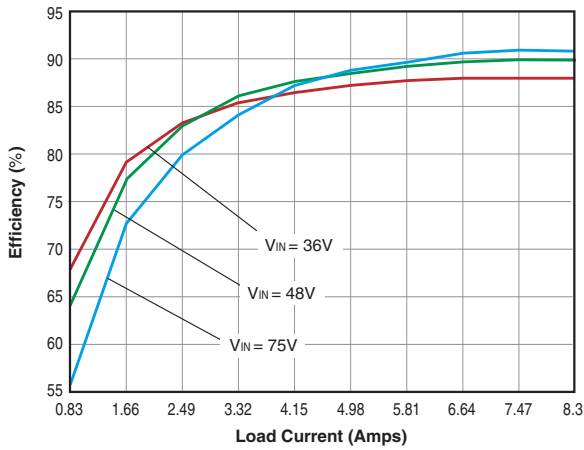

**Start-Up from V<sub>IN</sub>**

(V<sub>IN</sub> = 48V, I<sub>OUT</sub> = 8.3A, C<sub>OUT</sub> = 10μF tantalum || 1μF ceramic.)

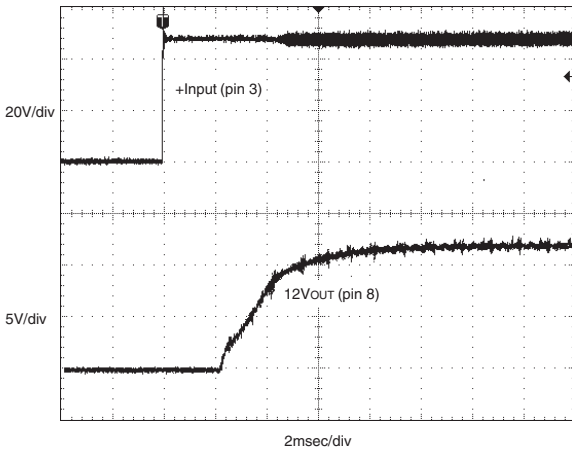

**USQ-12/8.3-D48: Output Current vs. Ambient Temperature**

(Transverse air flow, pin 1 to pin 3; V<sub>IN</sub> = 48V, no heat sink.)

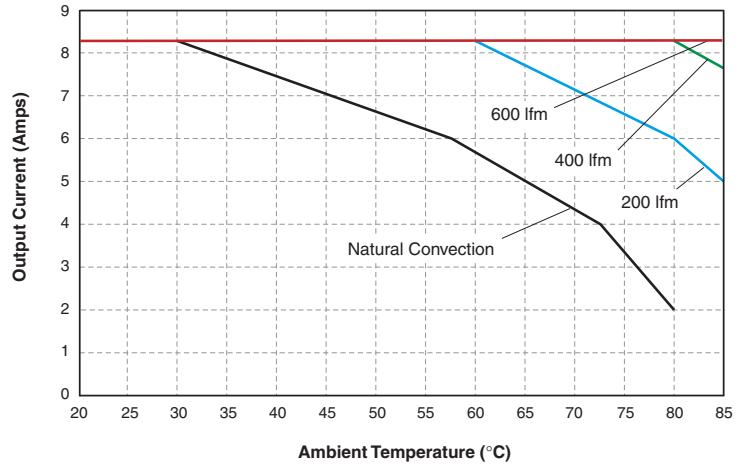

**USQ-12/8.3-D48: Output Current vs. Ambient Temperature**

(Longitudinal air flow, pin 1 to pin 3; V<sub>IN</sub> = 48V, no heat sink.)

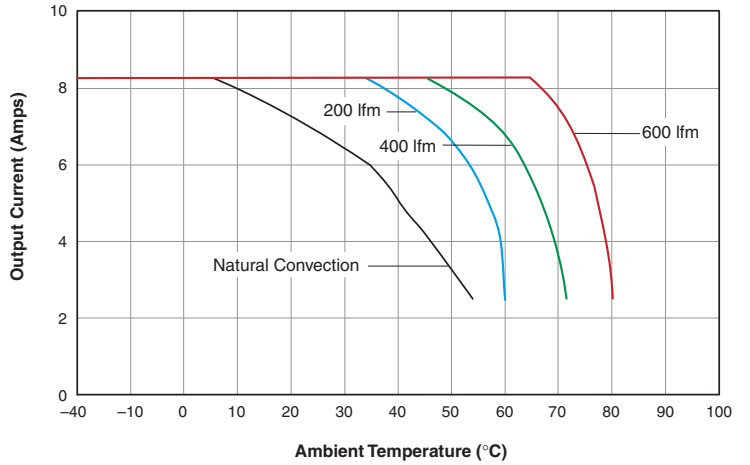

The USQ Series 12V models are discontinued. These Performance Curves are for documentation purposes only. Refer to DATEL's ULQ or UVQ series for alternate models.

**Typical Performance Curves for 12V<sub>OUT</sub> Models**

**Start-Up from Remote On/Off Control**  
 (V<sub>IN</sub> = 48V, I<sub>OUT</sub> = 8.3A, C<sub>OUT</sub> = 10μF tantalum || 1μF ceramic.)

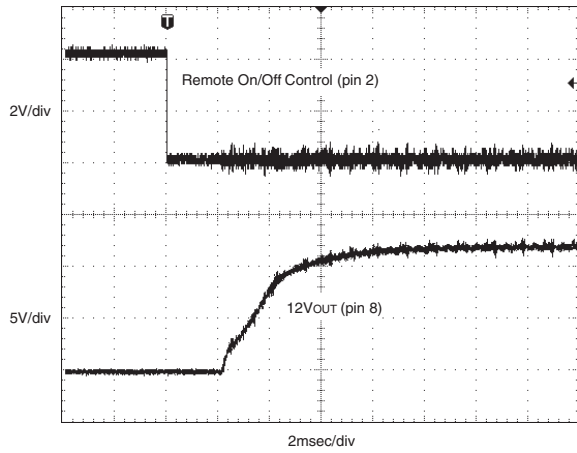

**USQ-12/8.3-D24: Output Current vs. Ambient Temperature**  
 (Transverse air flow, pin 1 to pin 3; V<sub>IN</sub> = 24V, no heat sink.)

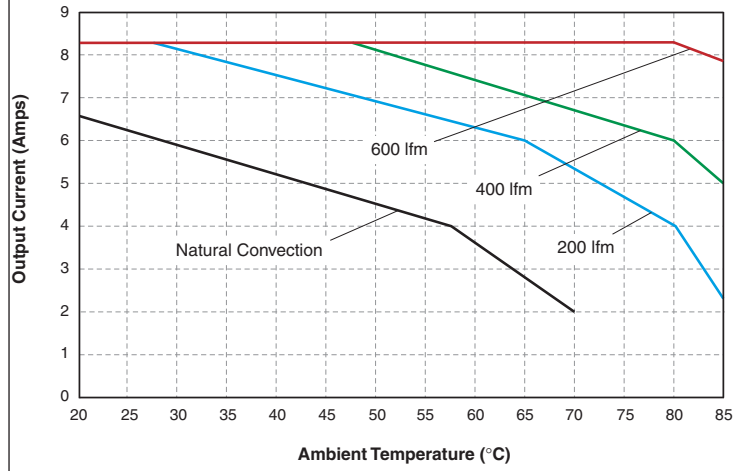

**USQ-12/8.3-D24: Output Current vs. Ambient Temperature**  
 (Transverse air flow, pin 1 to pin 3; V<sub>IN</sub> = 24V, 1/2" heat sink.)

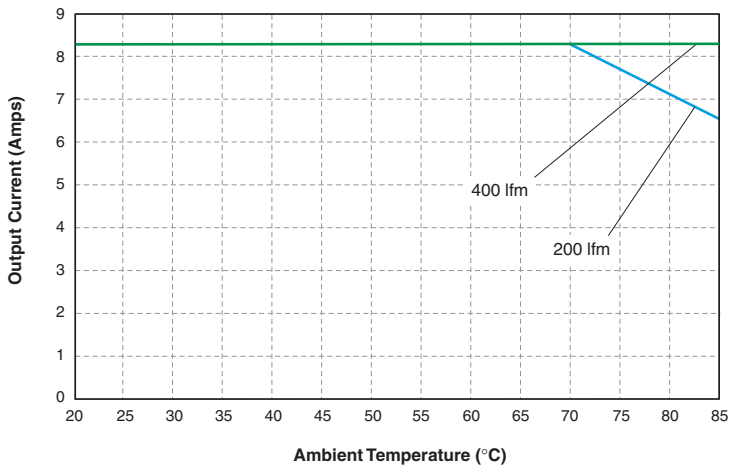

The USQ Series 12V models are discontinued. These Performance Curves are for documentation purposes only. Refer to DATEL's ULQ or UVQ series for alternate models.

**Typical Performance Curves for 15V<sub>OUT</sub> Models**

**USQ-15/6.7-D48 Efficiency vs. Line Voltage/Load Current @ 25°C**

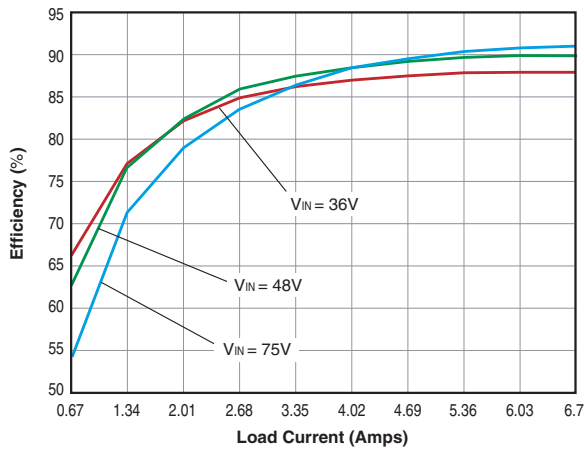

**USQ-15/6.7-D48: Maximum Output Current vs. Ambient Temperature**  
(Transverse air flow, pin 1 to pin 3; V<sub>IN</sub> = 48V, no heat sink.)

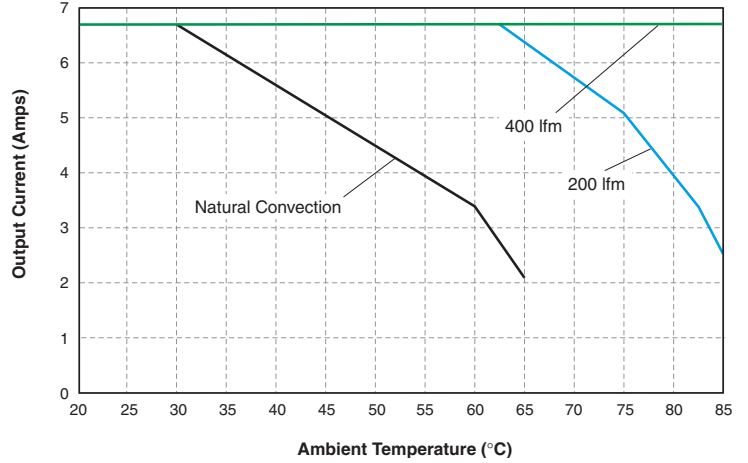

**Start-Up from Remote On/Off Control**  
(V<sub>IN</sub> = 48V, I<sub>OUT</sub> = 6.7A, C<sub>OUT</sub> = 10μF tantalum || 1μF ceramic.)

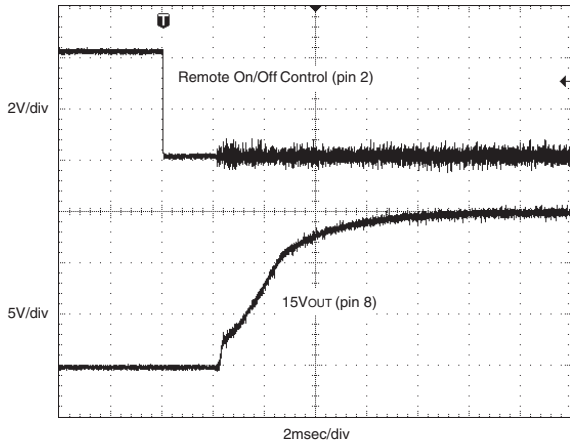

**USQ-15/6.7-D48: Maximum Output Current vs. Ambient Temperature**  
(Longitudinal air flow, pin 1 to pin 3; V<sub>IN</sub> = 48V, no heat sink.)

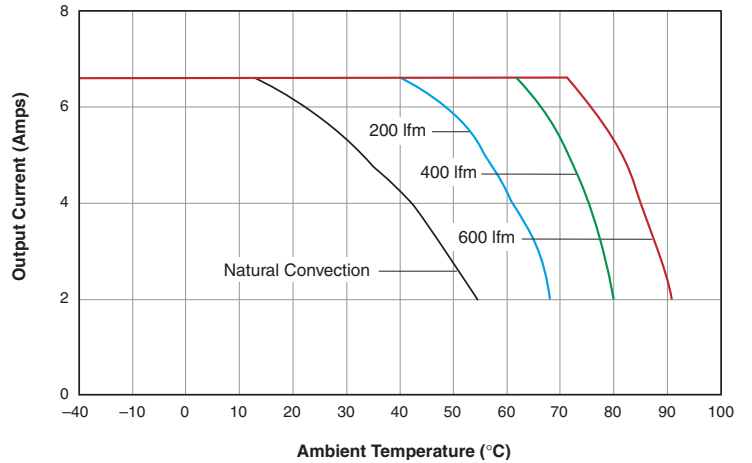

**Start-Up from V<sub>IN</sub>**  
(V<sub>IN</sub> = 48V, I<sub>OUT</sub> = 6.7A, C<sub>OUT</sub> = 10μF tantalum || 1μF ceramic.)

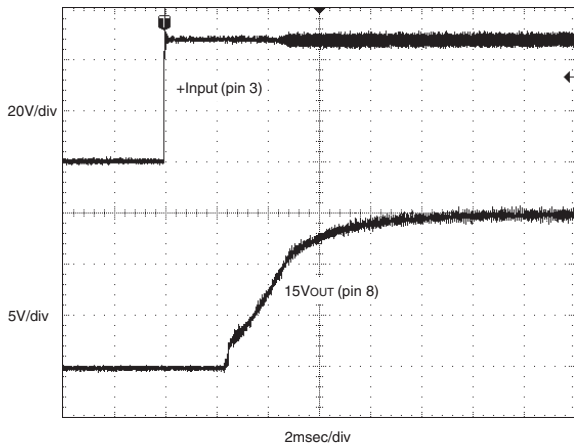



Typical Performance Curves for 24V<sub>OUT</sub> Models

USQ-24/4.2-D48 Efficiency vs. Line Voltage/Load Current @ 25°C

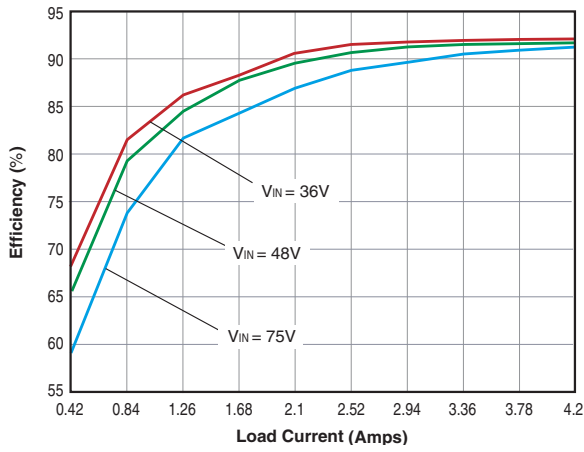

USQ-24/4.2-D48: Maximum Output Current vs. Ambient Temperature (Transverse air flow, pin 1 to pin 3; V<sub>IN</sub> = 48V, no heat sink.)

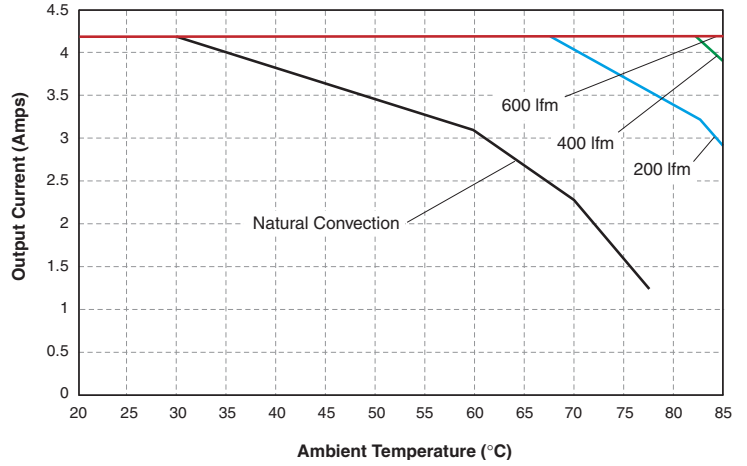

USQ-24/4.2-D24 Efficiency vs. Line Voltage/Load Current @ 25°C

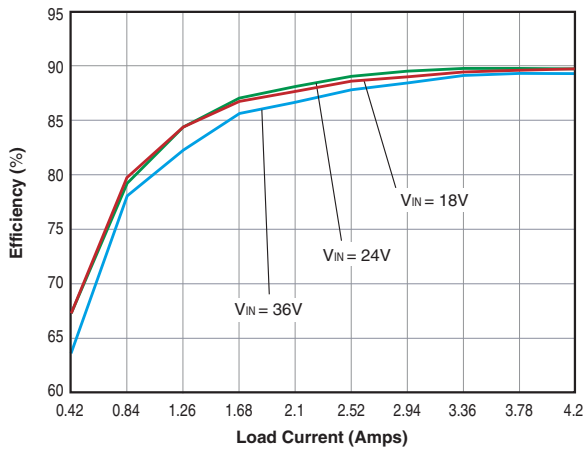

USQ-24/4.2-D24: Maximum Output Current vs. Ambient Temperature (Transverse air flow, pin 1 to pin 3; V<sub>IN</sub> = 24V, no heat sink.)

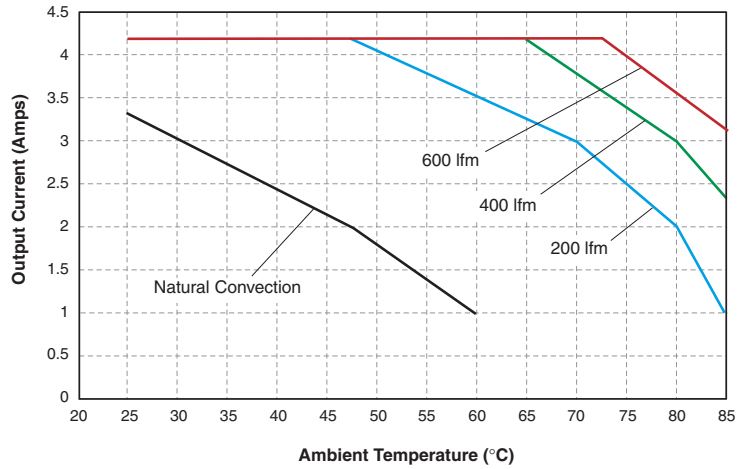

Start-Up from V<sub>IN</sub> (V<sub>IN</sub> = 48V, I<sub>OUT</sub> = 4.2A, C<sub>OUT</sub> = 10µF tantalum || 1µF ceramic.)

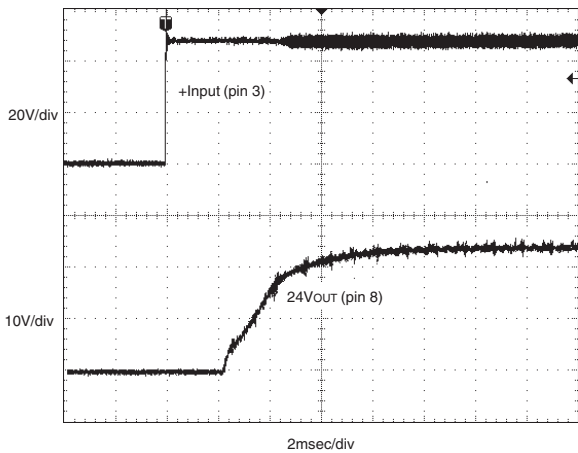

Start-Up from Remote On/Off Control (V<sub>IN</sub> = 48V, I<sub>OUT</sub> = 4.2A, C<sub>OUT</sub> = 10µF tantalum || 1µF ceramic.)

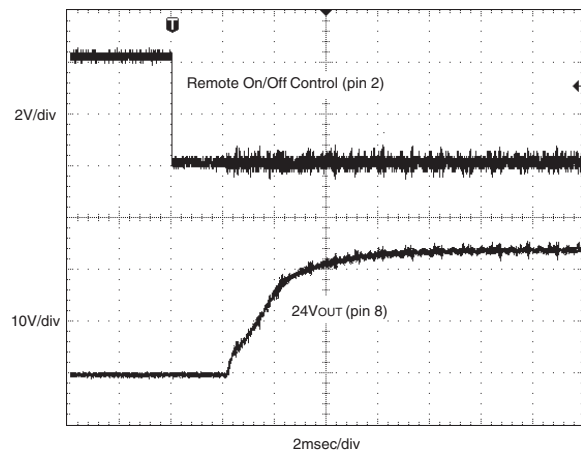

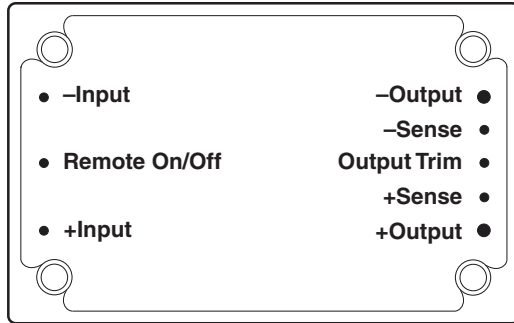

BOTTOM VIEW

Figure 20. Industry Standard Quarter-Brick Pinout

Figure 20 readily allows users to confirm that DATEL quarter-brick DC/DC converters are compatible to the industry-standard pinout, independent of pin-numbering conventions.

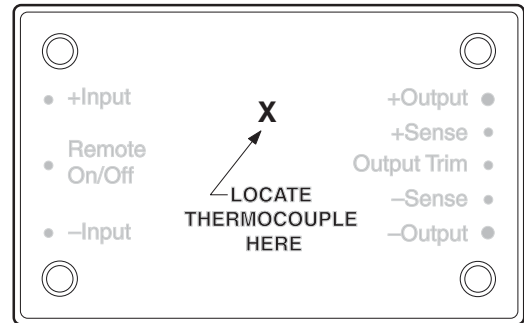

TOP VIEW

Figure 21. Thermocouple Placement for Temperature Derating Calculations

The typical derating curves on the previous pages were developed by monitoring the temperature of the case with a thermocouple placed on top of the USQ case as shown in Figure 21. Users desiring to model their own application's temperature derating for a particular environment (enclosed area, orientation, airflow, possible heatsinking) should make sure the case temperature does not exceed 110°C for any condition.



DATEL, Inc. 11 Cabot Boulevard, Mansfield, MA 02048-1151  
 Tel: (508) 339-3000 (800) 233-2765 Fax: (508) 339-6356  
**www.datel.com** Email: **sales@datel.com**  
**www.cdpowerelectronics.com**

ISO 9001 REGISTERED

DS-0493D 10/04

**DATEL (UK) LTD.** Tadley, England Tel: (01256)-880444  
 Internet: [www.datel-europe.com](http://www.datel-europe.com) E-mail: [datel.ltd@datel.com](mailto:datel.ltd@datel.com)

**DATEL S.A.R.L.** Montigny Le Bretonneux, France Tel: 01-34-60-01-01  
 Internet: [www.datel-europe.com](http://www.datel-europe.com) E-mail: [datel.sarl@datel.com](mailto:datel.sarl@datel.com)

**DATEL GmbH** München, Germany Tel: 89-544334-0  
 Internet: [www.datel-europe.com](http://www.datel-europe.com) E-mail: [datel.gmbh@datel.com](mailto:datel.gmbh@datel.com)

**DATEL KK** Tokyo, Japan Tel: 3-3779-1031, Osaka Tel: 6-6354-2025  
 Internet: [www.datel.co.jp](http://www.datel.co.jp) Email: [salestko@datel.co.jp](mailto:salestko@datel.co.jp), [salesosa@datel.co.jp](mailto:salesosa@datel.co.jp)

**DATEL China** Shanghai, China Tel: 011-86-51317131  
 E-mail: [davidx@datel.com](mailto:davidx@datel.com)