

Custom solutions are available.

HOW TO ORDER

THFF 10 X - 50 F Y M

Packaging
M = tape/reel B = bulk

TCR
Y = 50ppm/°C

Tolerance (%)
F = ±1% G = ±2% J = ±5%

Resistance (Ω)
50, 75, 100
special order: 150, 200, 250, 300

Lead Style (THFF10, THFF40 only)
X = Side Y = Top Z = Bottom

Rated Power W
10 = 10 W 100 = 100 W
40 = 40 W 150 = 150 W
50 = 50 W 250 = 250 W

Series
High Frequency Flanged Surface Mount Terminator



FEATURES

- Low return loss
- High power dissipation from 10W up to 250W
- Long life, temperature stable thin film technology
- Utilizes the combined benefits flange cooling and the high thermal conductivity of aluminum nitride (AlN)
- Single-sided or double-sided flanges
- Single leaded terminal configurations, adding increased RF design flexibility

APPLICATIONS

- Industrial RF power Sources
- Wireless Communication
- Fixed transmitters for mobile systems & measurement
- Power Amplifiers
- Satellites
- Aerospace

DERATING CURVE

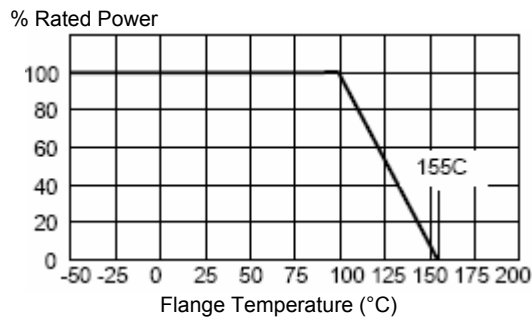

ELECTRICAL DATA

	THFF10	THFF40	THFF50	THFF100	THFF120	THFF150	THFF250
Power Rating	10 W	40 W	50 W	100 W	120 W	150 W	250 W
Capacitance	< 0.5pF	< 0.5pF	< 1.0pF	< 1.0pF	< 1.0pF	< 1.0pF	< 1.0pF
Rated Voltage	$\sqrt{P \times R}$, where P is Power Rating and R is Resistance						
Absolute TCR	±50ppm/°C						
Frequency Range	DC to 3GHz						
Tolerance	±1%, ±2%, ±5%						
Operating/Rated Temp Range	-55°C ~ +155°C						
VSWR	< 1.1						
Resistance	Standard: 50Ω, 75Ω, 100Ω			Special Order: 150Ω, 200Ω, 250Ω, 300Ω			
Short Time Overload	5 times the rated power within 5 seconds						

SCHEMATIC – Termination Configuration

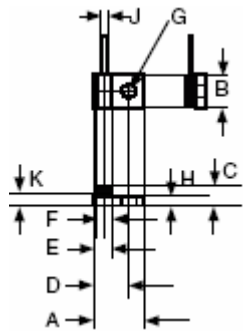

THFF10

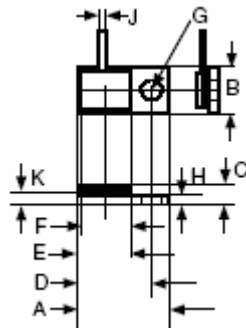

THFF40 (Z type)

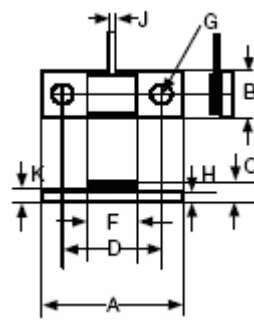

THFF50

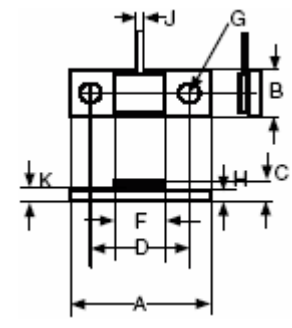

THFF100

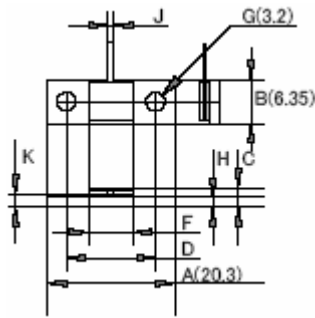

THFF120

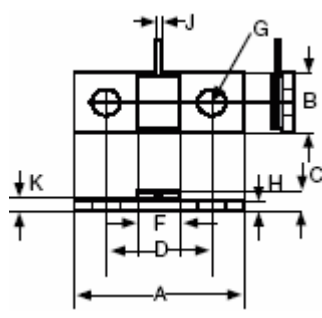

THFF150

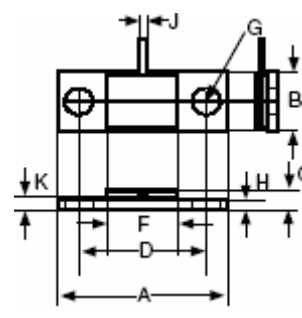

THFF250

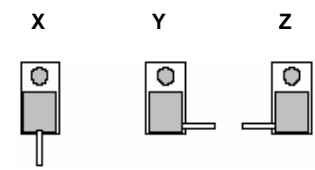

LEAD STYLES

X = AVAILABLE IN THFF40
Y,Z = AVAILABLE IN THFF10
THFF40

Lead Styles

DIMENSIONS (mm)

Series	A	B	C	D	E	F	G	H	J	K	Leads (l x w)
THFF10	7.6	5.10	3.1	5.00	3.0	3.0	2.9	1.5	0.8	2.2	5.08 x 0.1
THFF40	13.0	6.35	3.1	9.90	-	6.8	2.9	1.5	0.8	2.2	5.08 x 0.1
THFF50	20.3	5.70	3.10	14.20	-	8.5	3.2	1.5	1.5	2.6	5.08 x 0.1
THFF100	20.3	5.70	3.10	14.20	-	6.3	3.2	1.5	1.5	2.6	5.08 x 0.1
THFF120	20.3	6.35	3.1	14.20	-	8.9	3.2	1.5	0.8	2.2	5.08 x 0.1
THFF150	20.3	5.70	3.1	14.20	-	8.5	3.2	1.5	1.5	2.6	5.08 x 0.1
THFF250	25.0	9.53	4.6	18.42	-	9.6	3.2	3.0	3.0	4.1	5.08 x 0.1

VSWR DATA

THFF150-FYM

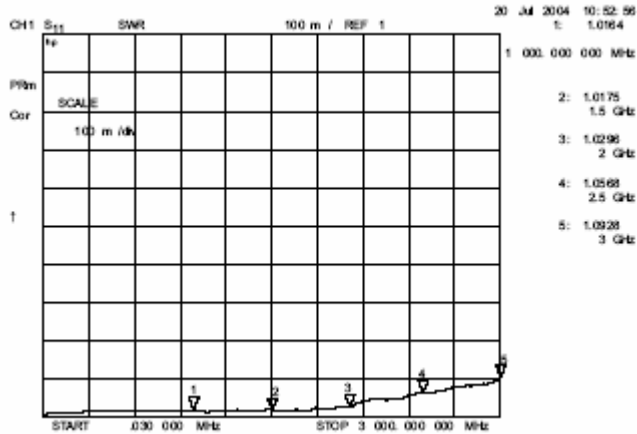

THFF250-FYM

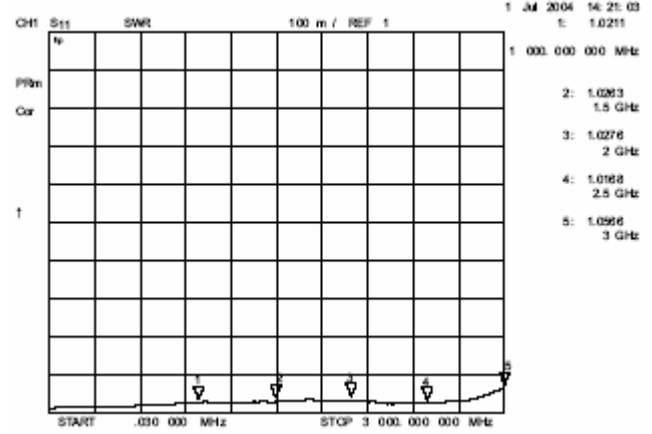

S11 DATA

THFF150-FYM

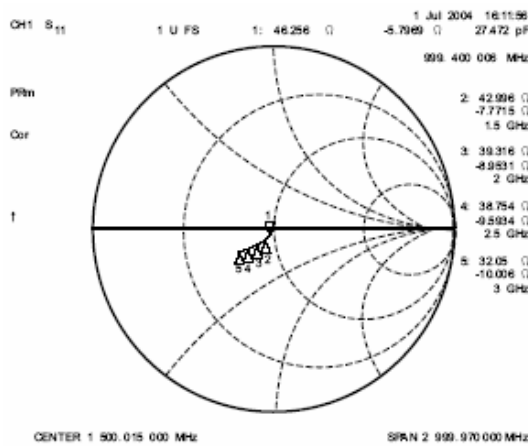

THFF250-FYM

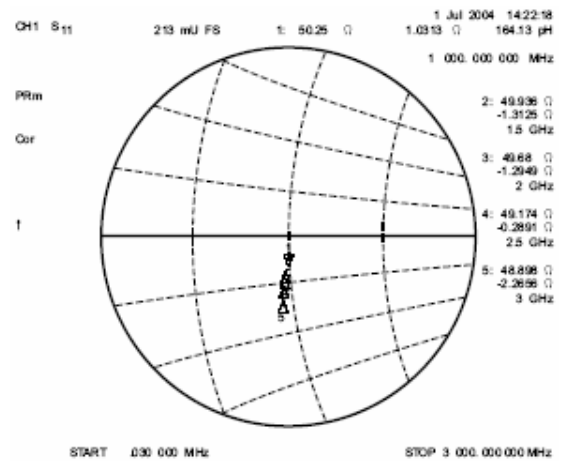

TEMPERATURE RISE with 0.2KW heat sink

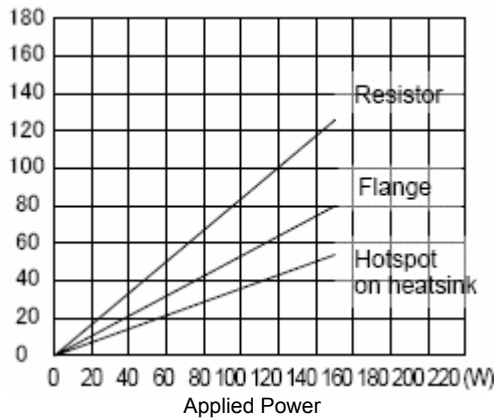

THFF150-50FYM

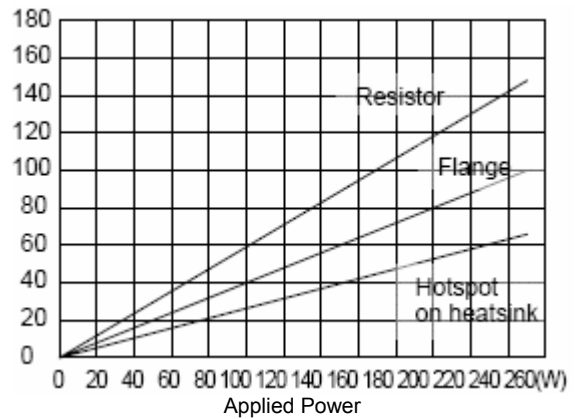

THFF250-50FYM