

INK0001AX SERIES

High speed switching
Silicon N-channel MOSFET

DESCRIPTION

INK0001AX is a Silicon N-channel MOSFET.
This product is most suitable for low voltage use such as portable machinery, because of low voltage drive and low on resistance.

FEATURE

- Input impedance is high, and not necessary to consider a drive electric current.
- V_{th} is low, and drive by low voltage is possible. $V_{th}=0.6\sim 1.2V$
- Low on Resistance. $R_{on}=3.5\Omega$ (TYP)
- High speed switching.
- Small package for easy mounting.

APPLICATION

high speed switching, Analog switching

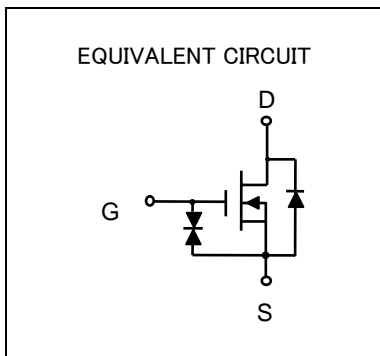

OUTLINE DRAWING

Unit: mm

INK0001AT2 (PRELIMINARY)	INK0001AM1
JEITA, JEDEC: — ISAHAYA: T-USM TERMINAL CONNECTOR ①: GATE ②: SOURCE ③: DRAIN	JEITA: SC-70 JEDEC: — TERMINAL CONNECTOR ①: GATE ②: SOURCE ③: DRAIN
JEITA: SC-75A JEDEC: — TERMINAL CONNECTOR ①: GATE ②: SOURCE ③: DRAIN	JEITA: SC-59 JEDEC: Similar to TO-236 T TERMINAL CONNECTOR ①: GATE ②: SOURCE ③: DRAIN

INK0001AX SERIES

High speed switching
Silicon N-channel MOSFET

MAXIMUM RATING (Ta=25°C)

SYMBOL	PARAMETER	RATING				UNIT
		INK0001AT2	INK0001AU1	INK0001AM1	INK0001AC1	
V _{DSS}	Drain-source voltage	50				V
V _{GSS}	Gate-source voltage	±8				V
I _D	Drain current	100				mA
P _D	Total power dissipation (Ta=25°C)	125(※)	150	200		mW
T _{ch}	Channel temperature	+125	+150			°C
T _{stg}	Range of Storage temperature	-55~+125	-55~+150			°C

ELECTRICAL CHARACTERISTICS (Ta=25°C)

※package mounted on 9mm × 19mm × 1mm glass-epoxy substrate.

SYMBOL	PARAMETER	TEST CONDITION	LIMIT			UNIT
			MIN	TYP	MAX	
V _{(BR)DSS}	Drain-source breakdown voltage	I _D =100 μA, V _{GS} =0V	50	-	-	V
I _{GSS}	Gate-source leak current	V _{GS} =±5V, V _{DS} =0V	-	-	±0.5	μA
I _{DSS}	Zero gate voltage drain current	V _{DS} =50V, V _{GS} =0V	-	-	50	μA
V _{th}	Gate threshold voltage	I _D =250 μA, V _{DS} =V _{GS}	0.6	-	1.2	V
Y _{fs}	Forward transfer admittance	V _{DS} =10V, I _D =0.1A	-	250	-	mS
R _{DS(ON)}	Static drain-source on-state resistance	I _D =100mA, V _{GS} =4.0V	-	3.5	-	Ω
C _{iss}	Input capacitance	V _{DS} =10V, V _{GS} =0V, f=1MHz	-	24	-	pF
C _{oss}	Output capacitance	V _{DS} =10V, V _{GS} =0V, f=1MHz	-	5	-	pF
t _{ON}	Switching time	V _{DD} =5V, I _D =10mA V _{GS} =0~5V	-	11	-	ns
t _{OFF}			-	50	-	

Switching time test condition

test circuit

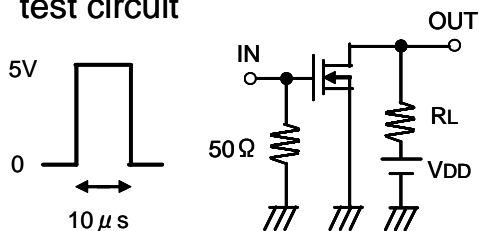

V_{DD}=5V
D.U. ≤ 1%
Common source
Ta=25°C

input waveform

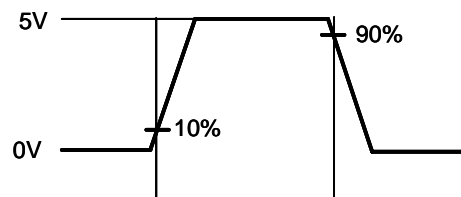

output waveform

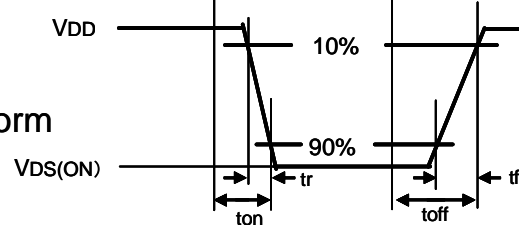

TYPICAL CHARACTERISTICS

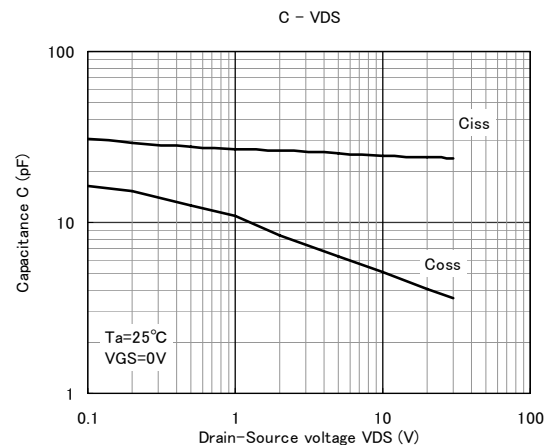
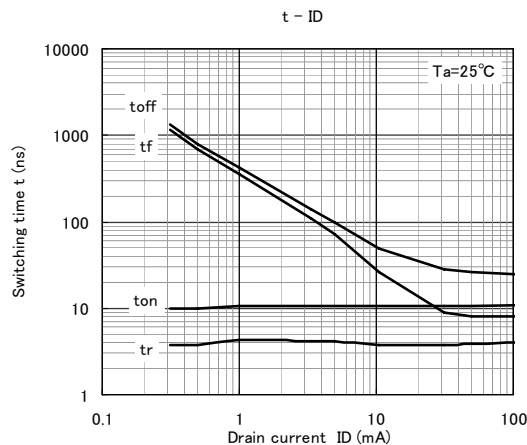
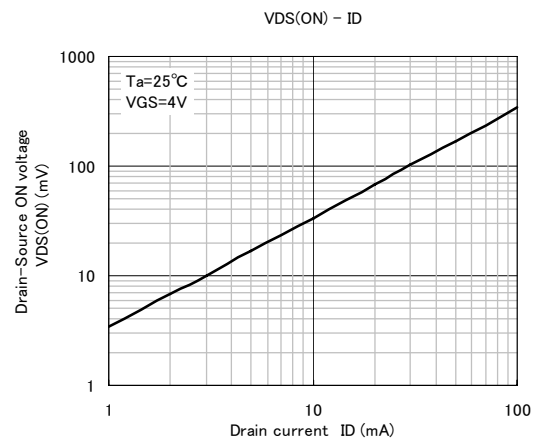
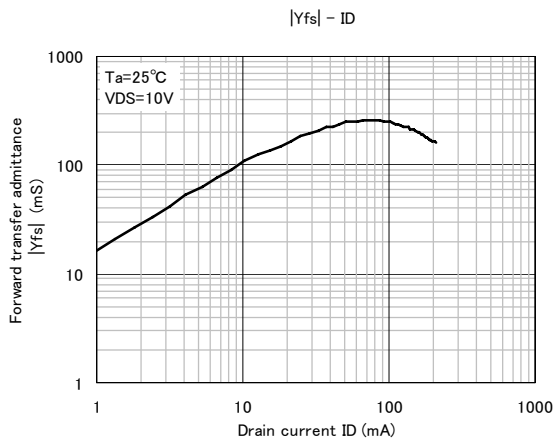
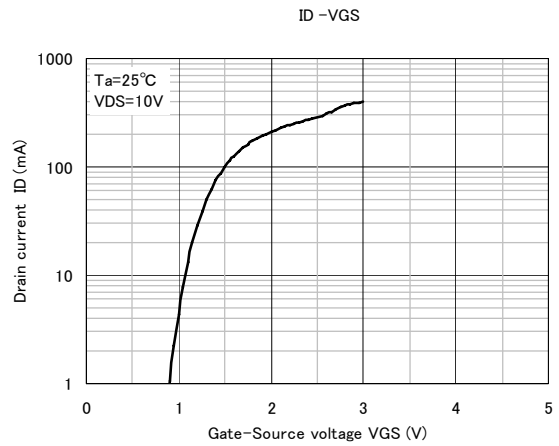
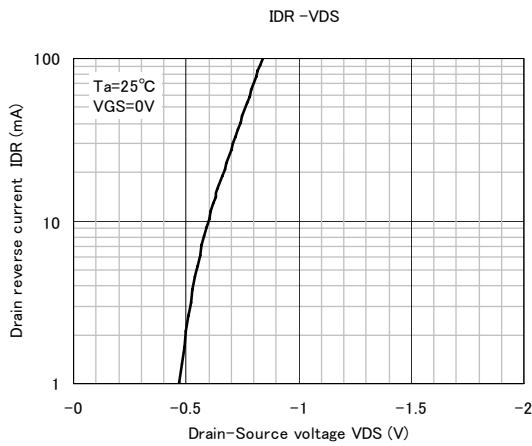
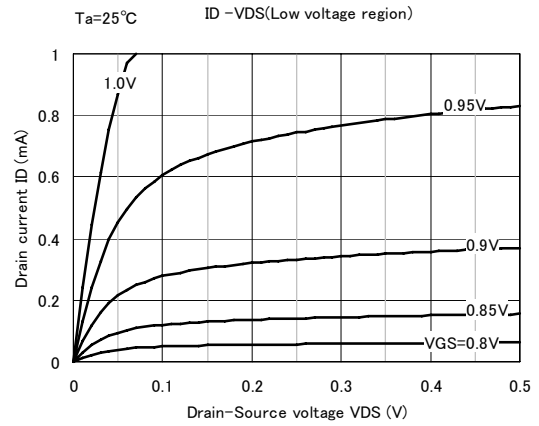
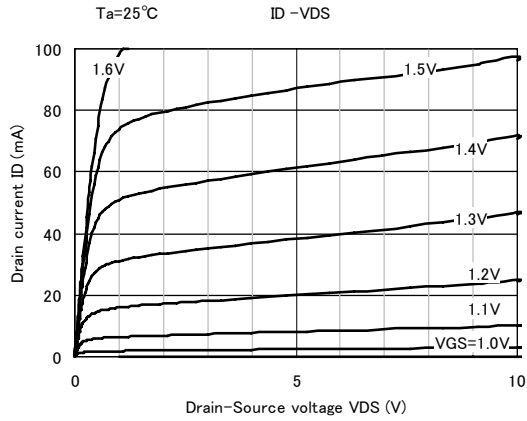



Marketing division, Marketing planning department

6-41 Tsukuba, Isahaya, Nagasaki, 854-0065 Japan

Keep safety first in your circuit designs!

•ISAHAYA Electronics Corporation puts the maximum effort into making semiconductor products better and more reliable, but there is always the possibility that trouble may occur with them. Trouble with semiconductors may lead to personal injury, fire or property damage. Remember to give due consideration to safety when making your circuit designs, with appropriate measures such as (1) placement of substitutive, auxiliary, (2) use of non-flammable material or (3) prevention against any malfunction or mishap.

Notes regarding these materials

- These materials are intended as a reference to our customers in the selection of the ISAHAYA products best suited to the customer's application; they don't convey any license under any intellectual property rights, or any other rights, belonging ISAHAYA or third party.
- ISAHAYA Electronics Corporation assumes no responsibility for any damage, or infringement of any third party's rights, originating in the use of any product data, diagrams, charts or circuit application examples contained in these materials.
- All information contained in these materials, including product data, diagrams and charts, represent information on products at the time of publication of these materials, and are subject to change by ISAHAYA Electronics Corporation without notice due to product improvements or other reasons. It is therefore recommended that customers contact ISAHAYA Electronics Corporation or an authorized ISAHAYA products distributor for the latest product information before purchasing product listed herein.
- ISAHAYA Electronics Corporation products are not designed or manufactured for use in a device or system that is used under circumstances in which human life is potentially at stake. Please contact ISAHAYA electronics corporation or an authorized ISAHAYA products distributor when considering the use of a product contained herein for any specific purposes, such as apparatus or systems for transportation, vehicular, medical, aerospace, nuclear, or undersea repeater use.
- The prior written approval of ISAHAYA Electronics Corporation is necessary to reprint or reproduce in whole or in part these materials.
- If these products or technologies are subject to the Japanese export control restrictions, they must be exported under a license from the Japanese government and cannot be imported into a country other than the approved destination. Any diversion or re-export contrary to the export control laws and regulations of Japan and/or the country of destination is prohibited.
- Please contact ISAHAYA Electronics Corporation or authorized ISAHAYA products distributor for further details on these materials or the products contained therein.