

MPH80E

SILICON EPITAXIAL PLANAR DIODE

Features

- High speed
- High reliability

Applications

- Ultra high speed switching

PINNING

PIN	DESCRIPTION
1	Cathode
2	Anode

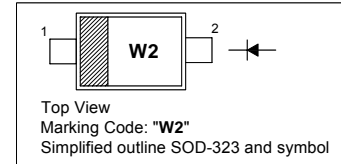

Absolute Maximum Ratings ($T_a = 25\text{ }^\circ\text{C}$)

Parameter	Symbol	Value	Unit
Peak Reverse Voltage	V_{RM}	80	V
Reverse Voltage	V_R	80	V
Mean Rectifying Current	I_O	100	mA
Peak Forward Current	I_{FM}	300	mA
Surge Current (1 μ s)	I_{surge}	4	A
Power Dissipation	P_{tot}	200	mW
Junction Temperature	T_j	150	$^\circ\text{C}$
Storage Temperature Range	T_{stg}	- 55 to + 150	$^\circ\text{C}$

Characteristics at $T_a = 25\text{ }^\circ\text{C}$

Parameter	Symbol	Max.	Unit
Forward Voltage at $I_F = 100\text{ mA}$	V_F	1.2	V
Reverse Current at $V_R = 70\text{ V}$	I_R	0.1	μA
Diode Capacitance at $V_R = 6\text{ V}$, $f = 1\text{ MHz}$	C_d	3.5	pF
Reverse Recovery Time at $I_F = 5\text{ mA}$, $V_R = 6\text{ V}$	t_{rr}	4	ns

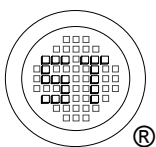

SEMTECH ELECTRONICS LTD.

(Subsidiary of Sino-Tech International Holdings Limited, a company listed on the Hong Kong Stock Exchange, Stock Code: 724)

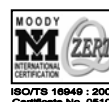

Capacitance

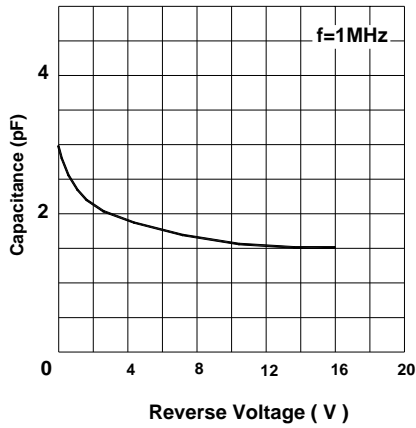

Reverse Recovery Time

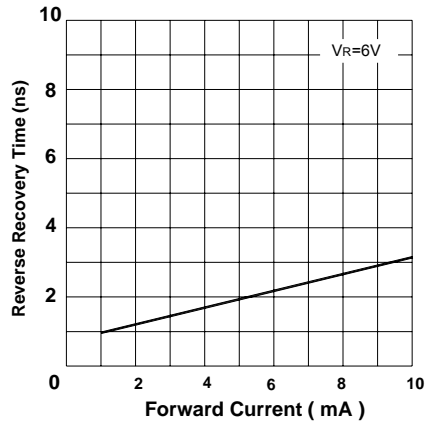

Power Attenuation Curve

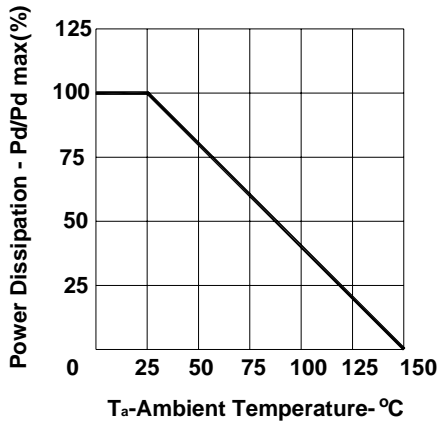

Forward Characteristics

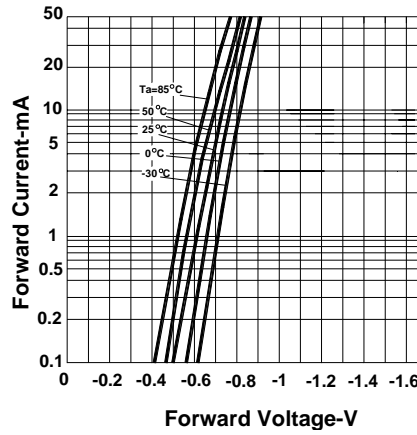

REVERSE CHARACTERISTICS

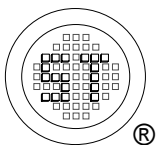
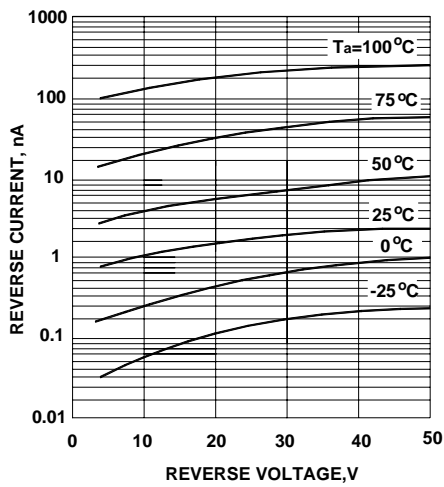

SEMTECH ELECTRONICS LTD.

(Subsidiary of Sino-Tech International Holdings Limited, a company listed on the Hong Kong Stock Exchange, Stock Code: 724)

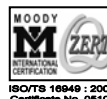

ISO/TS 16949 : 2002
Certificate No. 05103

ISO 14001:2004
Certificate No. 7116

ISO 9001:2000
Certificate No. 0506098

BS-OHSAS 18001: 2007
Certificate No. 7116

IECQ QC 080000
Certificate No. 0506098

MPH80E

PACKAGE OUTLINE

Plastic surface mounted package; 2 leads

SOD-323

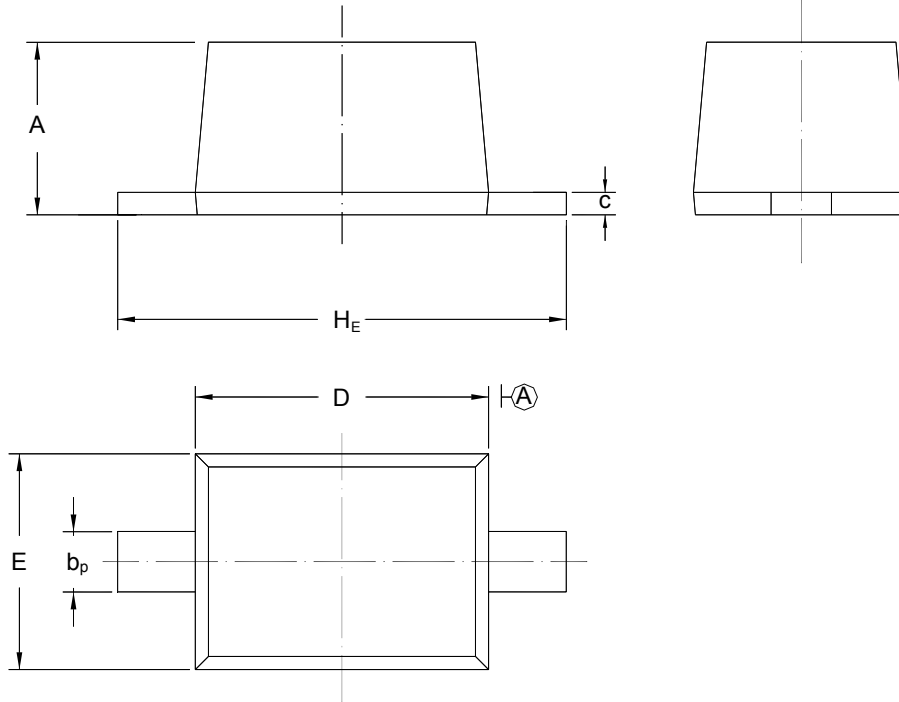

UNIT	A	b _p	C	D	E	H _E
mm	1.10 0.80	0.40 0.25	0.15 0.00	1.80 1.60	1.35 1.15	2.80 2.30

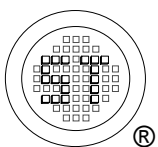

SEMTECH ELECTRONICS LTD.
 (Subsidiary of Sino-Tech International Holdings Limited, a company listed on the Hong Kong Stock Exchange, Stock Code: 724)

