

MORNSUN

VRB_LD-30W Series

**30W, WIDE INPUT, ISOLATED & REGULATED
SINGLE OUTPUT DC-DC CONVERTER**



multi-country patent protection **RoHS**

FEATURES

- High efficiency up to 88%
- 2:1 Wide Input Voltage Range
- 1.5KVDC Input/Output Isolation
- Six-sided Metal Shield
- Short Circuit Protection(automatic recovery)
- Operating Temperature: -40°C to +85°C
- Internal SMD construction
- Industry Standard Pin out
- MTBF>1,000,000 hours
- RoHS Compliance

PRODUCT PROGRAM

Part Number	Input			Output		Efficiency (%)	Capacitor Load Max
	Voltage (VDC)			Voltage (VDC)	Current (mA)		
	Nominal	Range	Max*				
VRB2403LD-30W	24	18 - 36	40	3.3	6000	84	6800
VRB2405LD-30W				5	6000	86	6800
VRB2412LD-30W				12	2500	87	680
VRB2415LD-30W				15	2000	87	680
VRB4803LD-30W	48	36-75	80	3.3	6000	84	6800
VRB4805LD-30W				5	6000	86	6800
VRB4812LD-30W				12	2500	88	680
VRB4815LD-30W				15	2000	87	680

*Input voltage above it may cause permanent damage to the device.

APPLICATION

The VRB_LD-30W series offer 30W of output, with 2:1 wide input voltage of 18-36VDC, 36-75VDC and features 1500VDC isolation, short-circuit and over current protection, as well as six-sided metal shield. All models are particularly suited to tele-communications, industrial, test equipments power.

INPUT SPECIFICATIONS

Item	Test conditions	Min.	Typ.	Max.	Units
Start-up time		--	20	--	mS
Under Voltage lock off	Nominal (24V)	Models ON	--	17.8	VDC
		Models OFF	16	--	
	Nominal (48V)	Models ON	--	35.8	
		Models OFF	33	--	
Input filter		L-C			
Ctrl	Models ON	3-40VDC			
	Models OFF	0-1.2VDC			
	Input current (Models OFF)	--	--	1	mA

MODEL SELECTION

VRB4812LD-30W

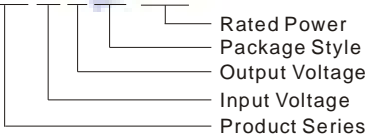

OUTPUT SPECIFICATIONS

Item	Test conditions	Min	Typ	Max	Units
Output power		--	--	30	W
Output voltage accuracy	Refer to recommended circuit	--	±1	±3	%
Load regulation	From 10% to 100% load Nominal input	--	±0.5	±1	
Line regulation	Input voltage from low to high 100% load	--	±0.2	±0.5	
Ripple and noise	20MHz bandwidth	--	50	120	
Transient recovery time	25% load step change	--	200	500	µS
Transient peak deviation		--	--	±5	%
Over current protection	Input voltage range	--	130	150	%
Short circuit protection	Input voltage range	Hiccup, automatic recovery			
Over voltage protection	3.3V output	--	3.9	--	VDC
	5V output	--	6.2	--	
	12V output	--	15	--	
	15V output	--	18	--	
Temperature drift (Vout)		--	--	±0.02	%/°C
Trim		--	±10%Vo	--	VDC

MORNSUN Science & Technology co.,Ltd.

Address: 2th floor 6th building, Huangzhou Industrial District, Guangzhou, China
Tel: 86-20-38601850
Fax: 86-20-38601272
[Http://www.mornsun-power.com](http://www.mornsun-power.com)

COMMON SPECIFICATIONS

Item	Test conditions	Min	Typ.	Max	Units
Storage humidity		5	--	95	%
Operating temperature		-40	--	85	°C
Storage temperature		-55	--	105	
Temp. Rise at full load		--	--	105	
Lead temperature	1.5mm from case for 10 seconds	--	--	300	
Isolation voltage	Test for 1 minute and 1 mA max	1500	--	--	VDC
Isolation resistance	Test at 500VDC	1000	--	--	MΩ
Isolation capacitance	100KHz/0.1V	--	1000	--	pF
Switching frequency	Nominal, full load	--	350	--	KHz
Cooling		Free Air Convection			
Case material		Nickel- coated copper			
MTBF		1000	--	--	K hours
Weight		--	40	--	g

TRIM APPLICATION & TRIM RESISTANCE

Application circuit for TRIM (Part in broken line is the interior of models)

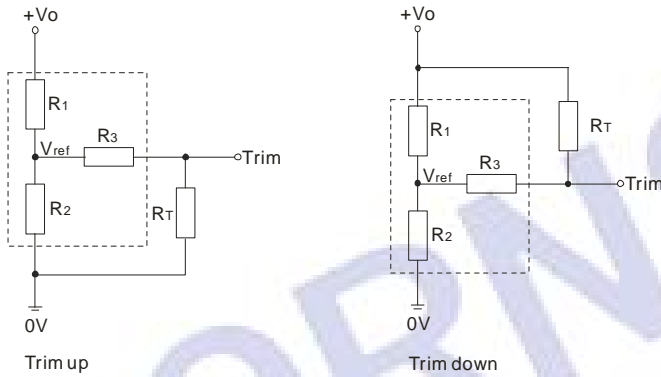

Formula for resistance of Trim

$$\begin{aligned} \text{up: } R_T &= \frac{aR_2}{R_2-a} - R_3 & a &= \frac{V_{ref}}{V_o - V_{ref}} \cdot R_1 \\ \text{down: } R_T &= \frac{aR_1}{R_1-a} - R_3 & a &= \frac{V_o - V_{ref}}{V_{ref}} \cdot R_2 \end{aligned}$$

Note: Value for R1, R2, R3, and Vref refer to the following table.
 RT: Resistance of Trim
 a: User-defined parameter, no actual meanings.

Vo(V)	3.3	5	12	15
Resistance				
R1(KΩ)	4.801	2.883	10.971	14.497
R2(KΩ)	2.863	2.864	2.864	2.864
R3(KΩ)	15	10	17.8	17.8
Vref(V)	1.24	2.5	2.5	2.5

RECOMMENDED CIRCUIT

① Recommended Circuit

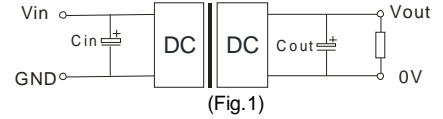

In order to obtain better performance for the DC/DC models, it's recommended that use input and output filters as Fig.1 shown.

② Recommended capacitance

Output Voltage	Cout (μF)	Cin (μF)
3.3	470/220	100
5	470/220	
12	220/100	
15	220/100	

③ No parallel connection or plug and play DERATING & EFFICIENCY CURVE

① Temperature derating curve (Free Air Convection)

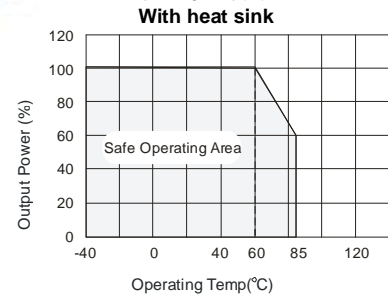
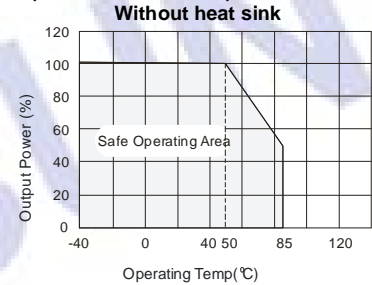

② Efficiency curve

VRB2415LD-30W

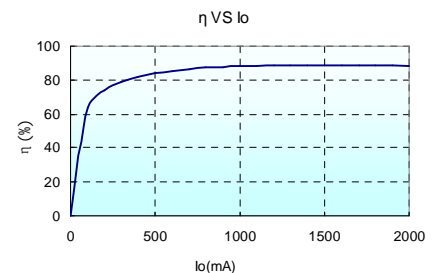
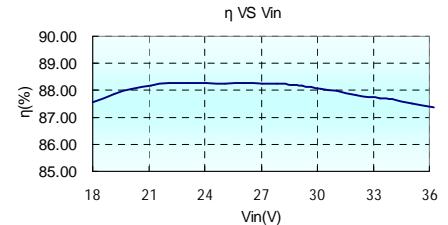

OUTLINE DIMENSIONS & FOOTPRINT DETAILS

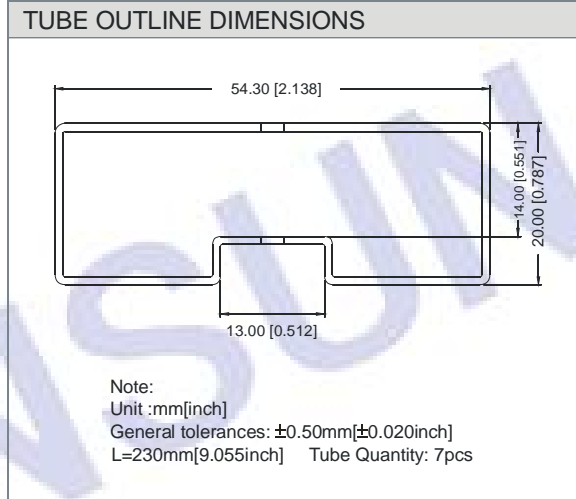
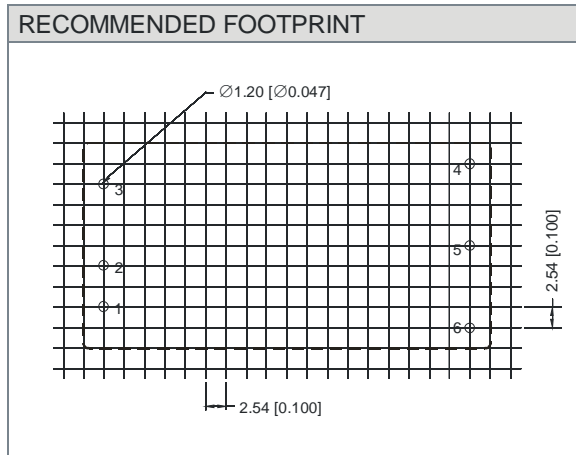
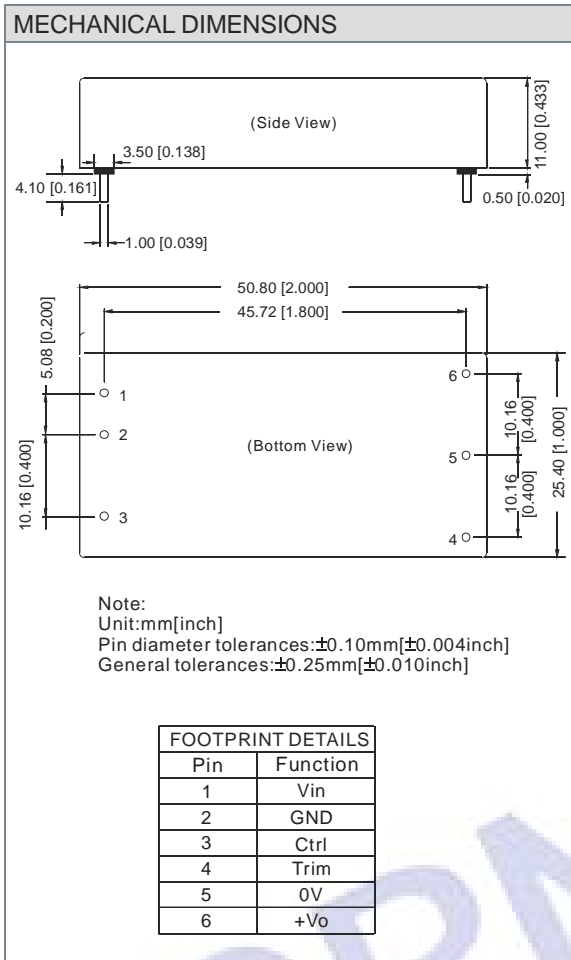

HEAT SINK DIMENSIONS

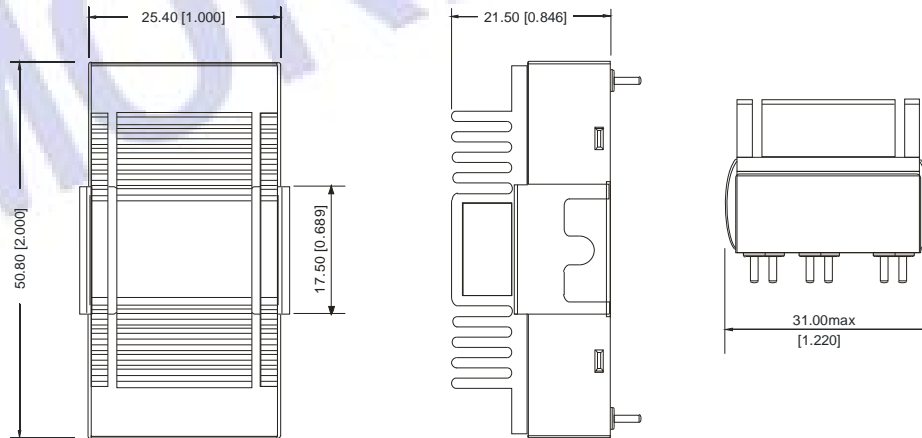

Note:
 Unit: mm[inch] tolerances:±0.5mm[±0.020inch]
 1. If use heat sinks, make sure there is enough space for a specific size in the above chart;
 2. Products will be supplied with heat sinks already mounted, separate heat sinks are not available .

- Note:
1. All specifications are measured at TA=25°C, humidity<75%, nominal input voltage and rated output load unless otherwise specified.
 2. In this datasheet, all the test methods of indications are based on corporate standards.
 3. Only typical model listed. Non-standard models will be different from the above, please contact us for more details.
 4. The CTRL control pin voltage is referenced to GND.
 5. Capacitor MAX load tested at nominal input voltage, full load and constant resistive load.