

PHASE CONTROL THYRISTOR H650TBXX

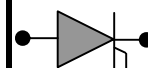

Symbol	Characteristics	Conditions	T_J ($^{\circ}\text{C}$)	Value	Unit
BLOCKING PARAMETERS					
V_{RRM}	Repetitive peak reverse voltage		125	200-600	V
V_{DRM}	Repetitive peak off-stage voltage		125	200-600	V
I_{RRM}	Repetitive peak reverse current	$V = V_{RRM}$	125	40	mA
I_{DRM}	Repetitive peak off-state current	$V = V_{RRM}$	125	40	mA
CONDUCTING PARAMETERS					
$I_{F(AV)}$	Average on-state current	180 sine, 50Hz, $T_C = 70^{\circ}\text{C}$		650	A
I_{RMS}	RMS on-state current			1020	A
I_{TSM}	Surge on-state current	Sine wave, 10mS without reverse voltage	125	14	kA
I^2t	I^2t			980	kA^2S
V_T	Peak on-state voltage drop	On-state current = 2 kA	125	1.35	V
V_0	Threshold voltage		125	1.00	V
R_0	On-state slope resistance		125	0.12	$\text{m}\Omega$
TRIGGERING PARAMETERS					
I_{GT}	Gate trigger current	$V_D = 5V$	25	300	mA
V_{GT}	Gate trigger voltage		25	2.00	V
I_L	Latching Current	$V_D = 5V$	25	1000	mA
P_{G-PEAK}	Maximum Peak Gate Power	Pulse width 100 μSec		160	W
di/dt	Repetitive rate of rise of current			120	$\text{A}/\mu\text{Sec}$
V_{FGM}	Maximum forward gate voltage			12	V
I_{FGM}	Maximum forward gate current			40	A
THERMAL & MECHANICAL PARAMETERS					
$R_{TH(J-C)}$	Thermal impedance, 180 conduction, Sine	Junction to case		0.070	$^{\circ}\text{C}/\text{W}$
$R_{TH(C-HK)}$	Thermal impedance	Case to heatsink		0.015	$^{\circ}\text{C}/\text{W}$
T_J	Maximum Permissible junction temperature			125	$^{\circ}\text{C}$
T_{STG}	Storage temperature range			-40 - 125	$^{\circ}\text{C}$
F	Mounting Torque			18	NM
W	Weight			875	gms



PHASE CONTROL THYRISTOR H650TBXX

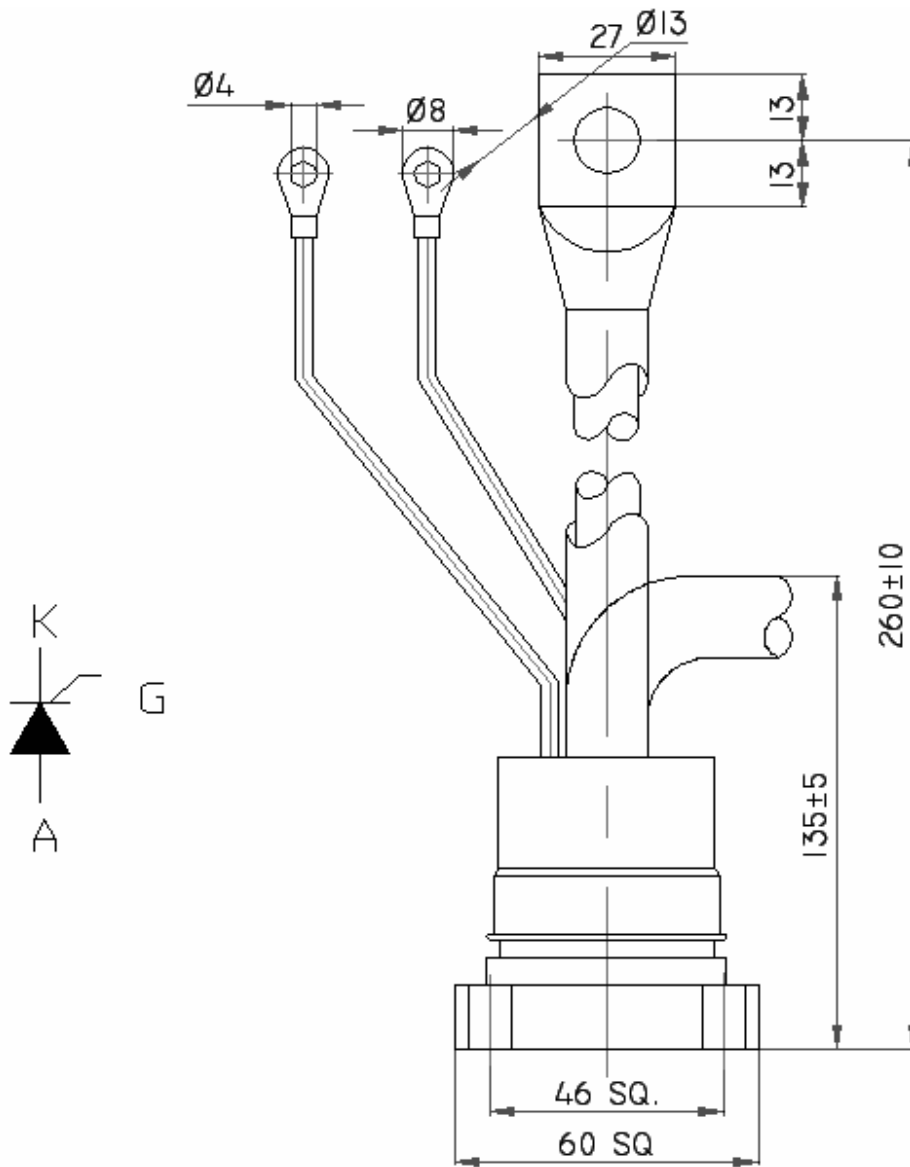
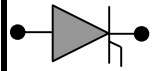

All dimensions in mm

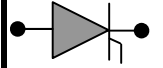

On State Power Loss

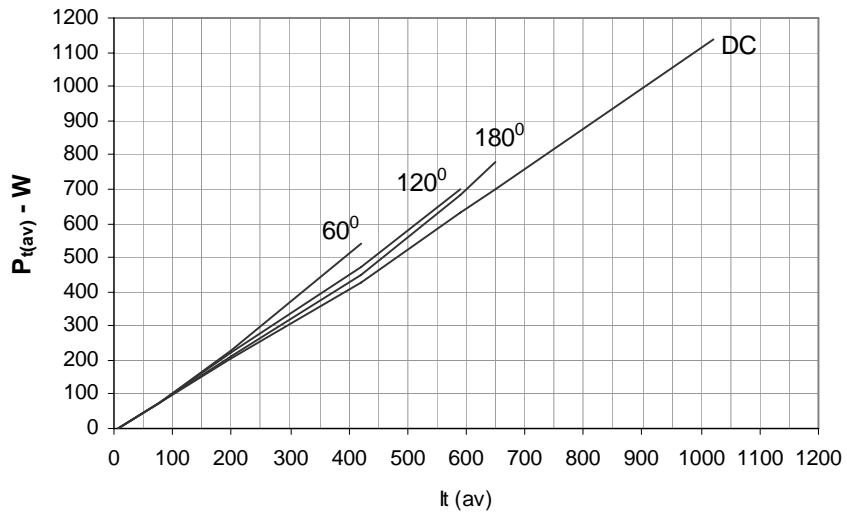

Maximum Permissible Case Temp

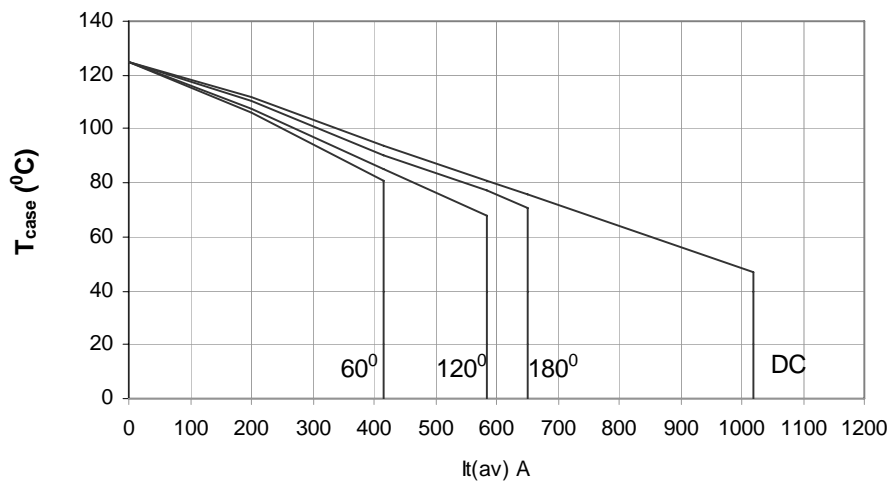

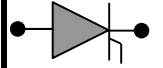

Max non repetitive Surge Current

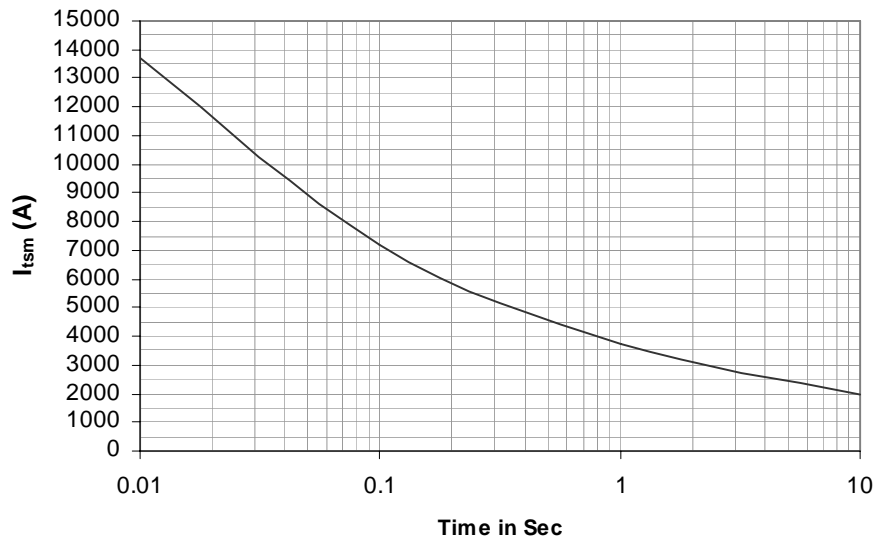

Transient Thermal Impedance Junction to Case

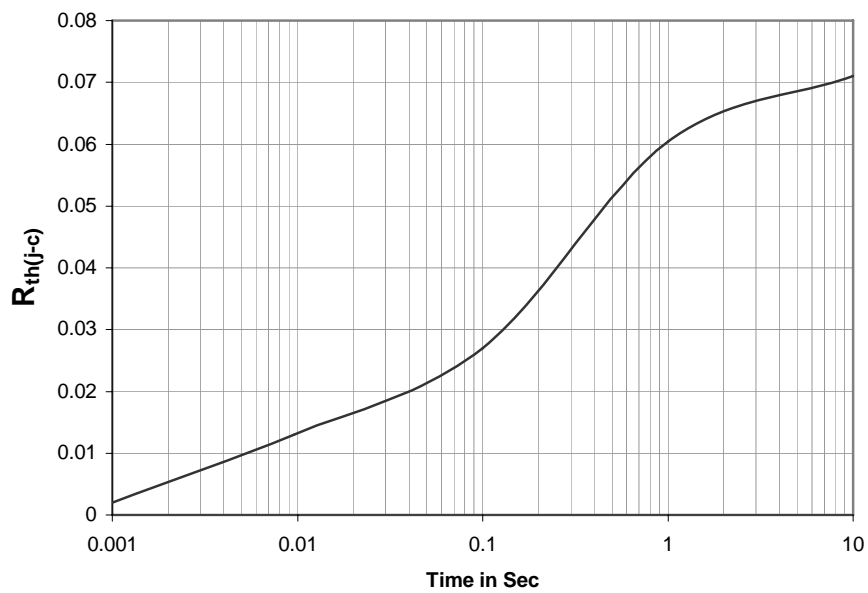

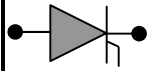

On State Characteristics

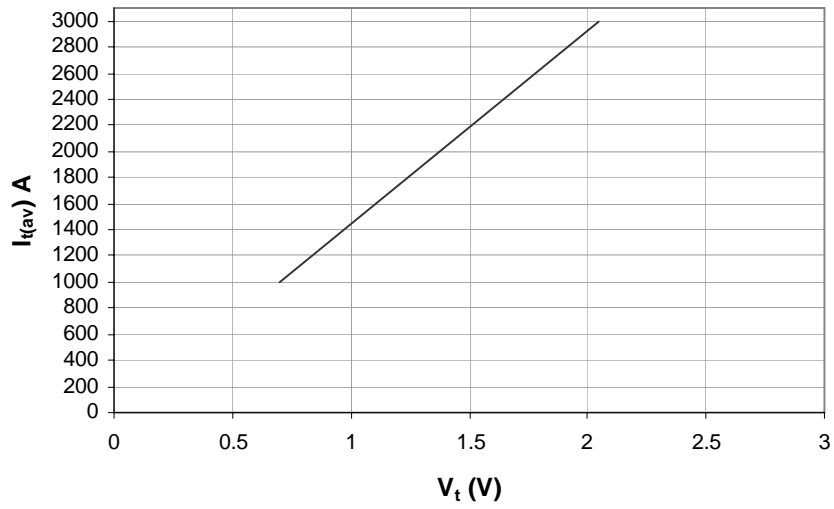

Gate Trigger Characteristics

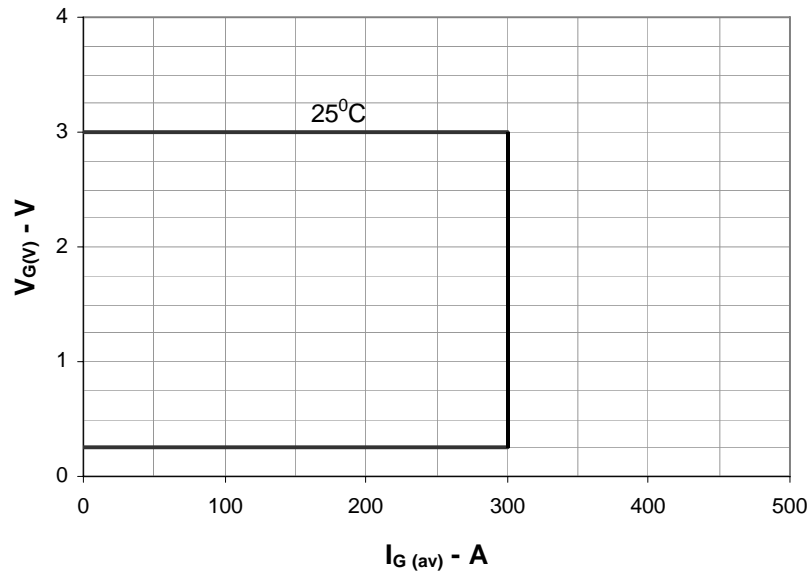

PHASE CONTROL THYRISTOR H650TBXX

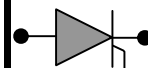

Ordering Information: -

H	650	TB	XX
Hirect make Thyristor	$I_{F(AV)} = 650A$	TB - with a Pigtail	$V_{RRM} = XX * 100$ e.g.12 * 100 =1200V

Hind Rectifiers Ltd reserves the right to change the specifications without notice.

This datasheet specifies technical information for semiconductor devices but promises no characteristics. No warranty or guarantee expressed or implied is made regarding delivery, performance or suitability.

Hind Rectifiers Ltd
Lake Road
Bhandup (West)
Mumbai – 400 078
Tel: - +91 22 2596 8027/28/29/31
Fax: - +91 22 2596 4114
E-mail: - marketing@hirect.com
Website: - www.hirect.com

June-2008



HIND RECTIFIERS LTD

6 of 6