

Silicon NPN Power Transistors

2SD2241

DESCRIPTION

- With TO-220F package
- High DC current gain : $h_{FE}=2000$ (Min)
- Low saturation voltage
- Complement to type 2SB1481
- DARLINGTON

APPLICATIONS

- With switching applications

PINNING

PIN	DESCRIPTION
1	Base
2	Collector
3	Emitter

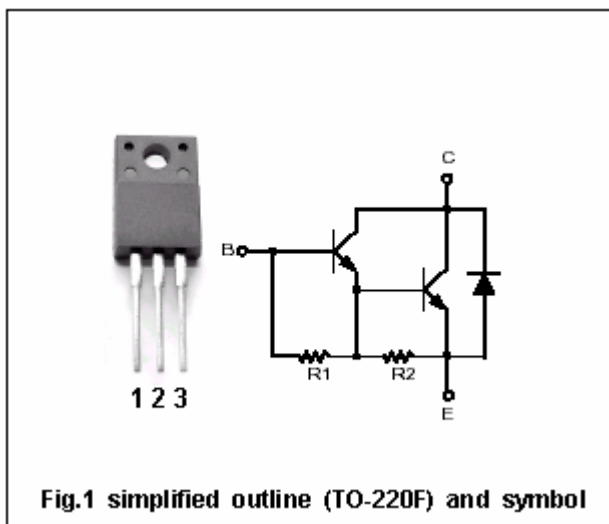

Absolute maximum ratings ($T_a=25^\circ\text{C}$)

SYMBOL	PARAMETER	CONDITIONS	VALUE	UNIT
V_{CBO}	Collector-base voltage	Open emitter	100	V
V_{CEO}	Collector-emitter voltage	Open base	100	V
V_{EBO}	Emitter-base voltage	Open collector	5	V
I_C	Collector current		± 4	A
I_{CM}	Collector current-peak		± 6	A
I_B	Base current		0.3	A
P_C	Collector dissipation	$T_a=25^\circ\text{C}$	2.0	W
		$T_C=25^\circ\text{C}$	25	
T_j	Junction temperature		150	$^\circ\text{C}$
T_{stg}	Storage temperature		-55~150	$^\circ\text{C}$

Silicon NPN Power Transistors

2SD2241

CHARACTERISTICS

T_j=25°C unless otherwise specified

SYMBOL	PARAMETER	CONDITIONS	MIN	TYP.	MAX	UNIT
V _{(BR)CEO}	Collector-emitter breakdown voltage	I _C =10mA ; I _B =0	100			V
V _{CEsat}	Collector-emitter saturation voltage	I _C =3A ; I _B =6mA			1.5	V
V _{BEsat}	Base-emitter saturation voltage	I _C =3A ; I _B =6mA			2.0	V
I _{CBO}	Collector cut-off current	V _{CB} =100V ; I _E =0			20	μA
I _{EBO}	Emitter cut-off current	V _{EB} =5V ; I _C =0			2.5	mA
h _{FE-1}	DC current gain	I _C =1.5A ; V _{CE} =2V	2000			
h _{FE-2}	DC current gain	I _C =3A ; V _{CE} =2V	1000			
V _{ECF}	Diode forward voltage	I _E =1A ; I _B =0			2.0	V

Switching times

t _{on}	Turn-on time	I _{B1} =-I _{B2} =6mA V _{CC} ≈30V , R _L =10Ω Duty cycle≤1%		0.2		μs
t _s	Storage time			1.5		μs
t _f	Fall time			0.6		μs

Silicon NPN Power Transistors

2SD2241

PACKAGE OUTLINE

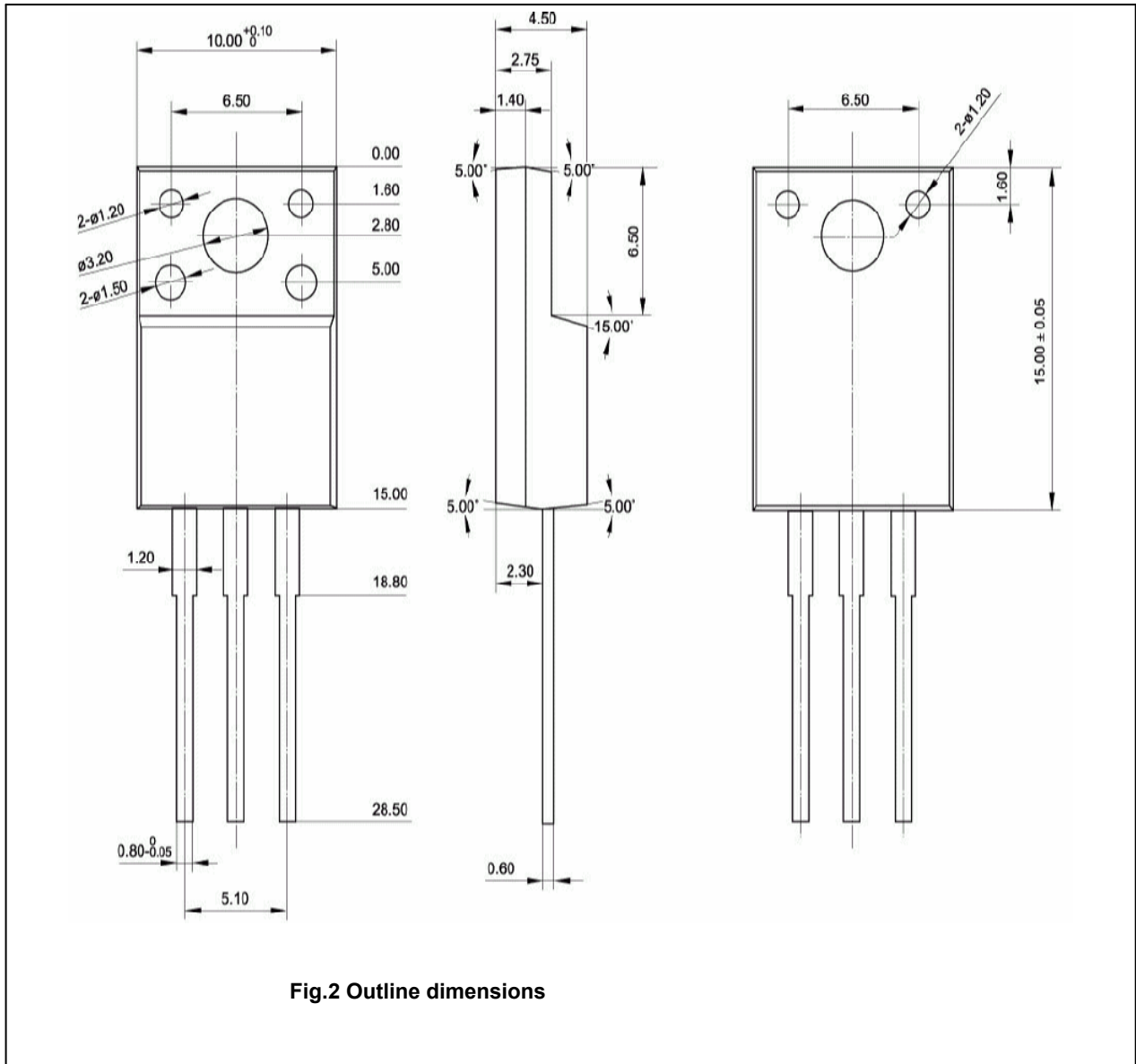

Silicon NPN Power Transistors

2SD2241

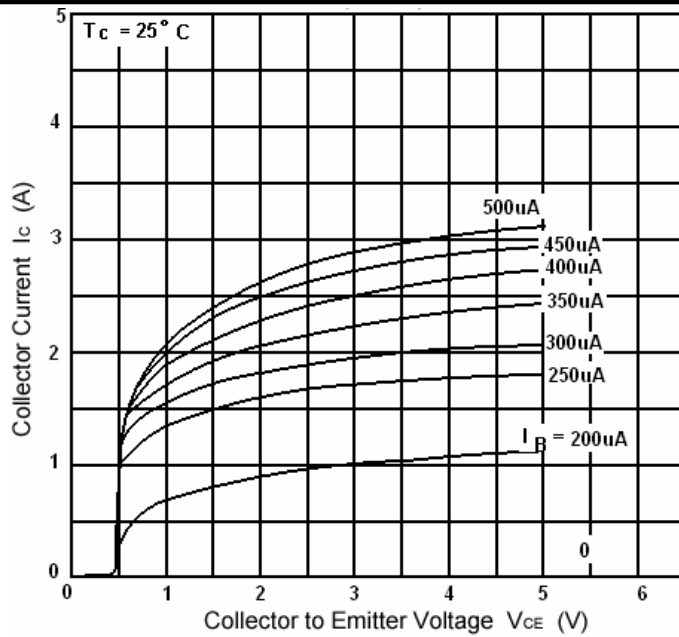

Fig.3 Static Characteristic

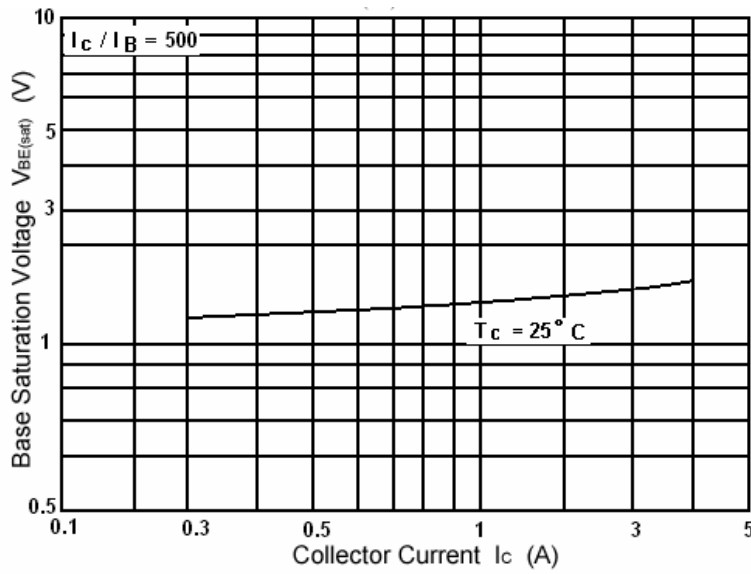

Fig.4 Base-Emitter Saturation Voltage

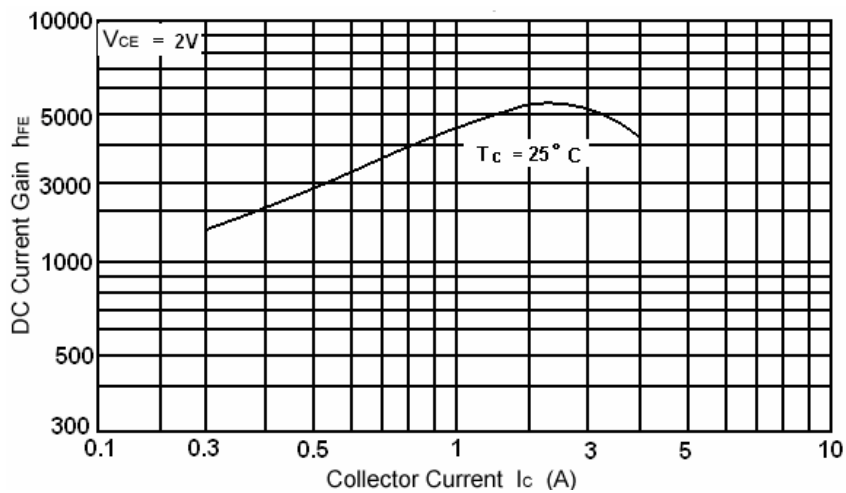

Fig.5 DC current Gain

Silicon NPN Power Transistors

2SD2241

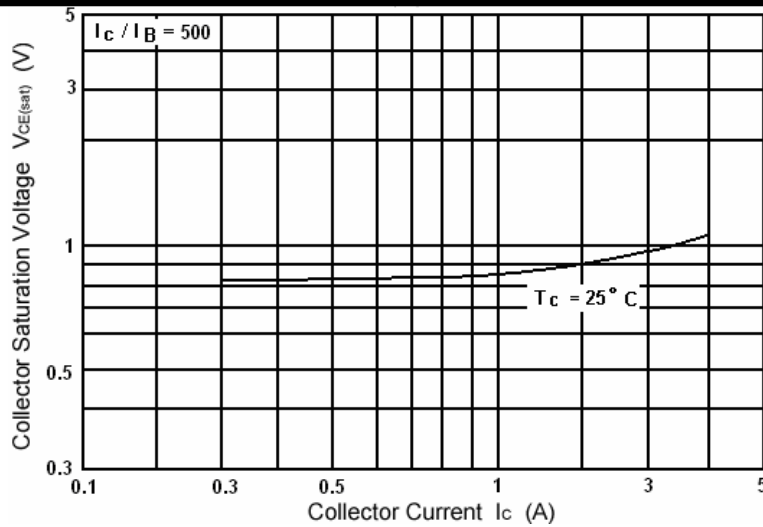

Fig.6 Collector-Emitter Saturation Voltage

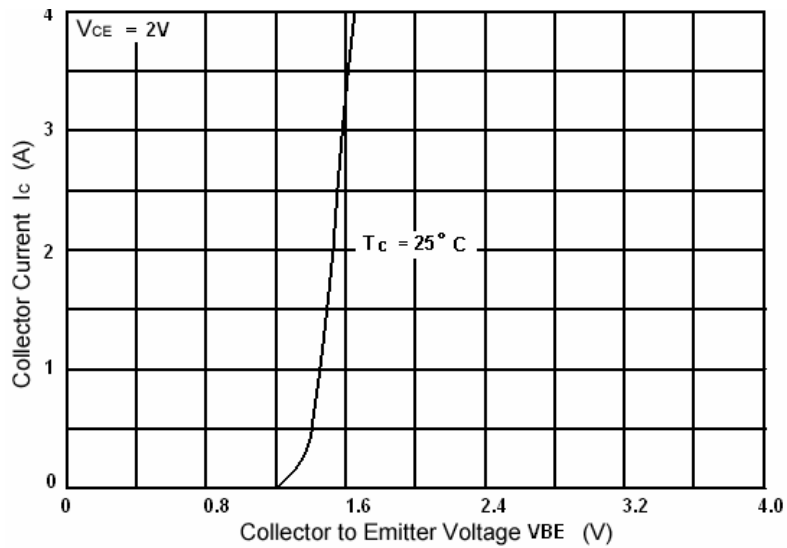

Fig.7 $I_c - V_{BE}$

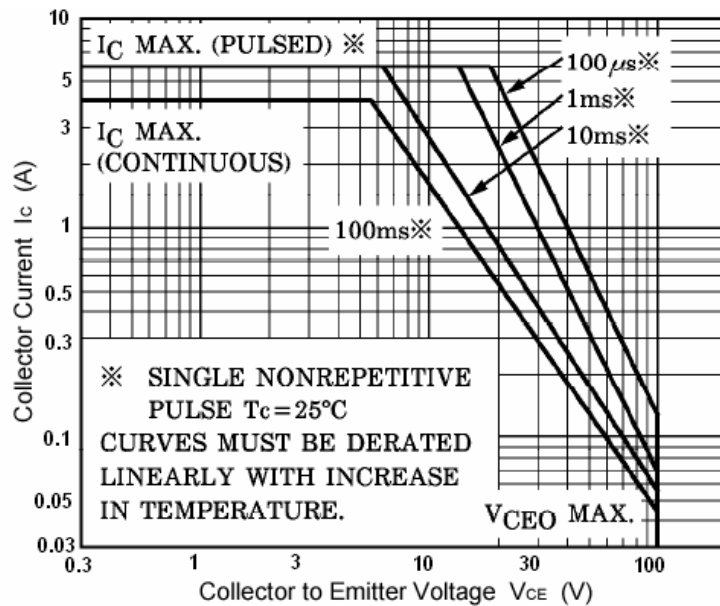

Fig.8 Safe Operating Area