

2-Mbit (128K x 16) Static RAM

Features

- **Very high speed**
 - 55 ns
- **Temperature Ranges**
 - Industrial: - 40°C to + 85°C
 - Automotive: - 40°C to + 125°C
- **Pin-compatible with the CY62137V**
- **Ultra-low active power**
 - Typical active current: 1.5 mA @ f = 1 MHz
 - Typical active current: 7 mA @ f = f_{Max} (55 ns speed)
- **Low and ultra-low standby power**
- **Easy memory expansion with \overline{CE} and \overline{OE} features**
- **Automatic power-down when deselected**
- **CMOS for optimum speed/power**
- **Available in Pb-free and non Pb-free 48-ball FBGA package**

Functional Description^[1]

The CY62137CV30/33 and CY62137CV are high-performance CMOS static RAMs organized as 128K words by 16 bits. These devices feature advanced circuit design to provide

ultra-low active current. This is ideal for providing More Battery Life™ (MoBL[®]) in portable applications such as cellular telephones. The devices also has an automatic power-down feature that significantly reduces power consumption by 80% when addresses are not toggling. The device can also be put into standby mode reducing power consumption by more than 99% when deselected (\overline{CE} HIGH or both \overline{BLE} and \overline{BHE} are HIGH). The input/output pins (I/O_0 through I/O_{15}) are placed in a high-impedance state when: deselected (\overline{CE} HIGH), outputs are disabled (\overline{OE} HIGH), both Byte High Enable and Byte Low Enable are disabled (\overline{BHE} , \overline{BLE} HIGH), or during a write operation (\overline{CE} LOW, and \overline{WE} LOW).

Writing to the device is accomplished by taking Chip Enable (\overline{CE}) and Write Enable (\overline{WE}) inputs LOW. If Byte Low Enable (\overline{BLE}) is LOW, then data from I/O pins (I/O_0 through I/O_7), is written into the location specified on the address pins (A_0 through A_{16}). If Byte High Enable (\overline{BHE}) is LOW, then data from I/O pins (I/O_8 through I/O_{15}) is written into the location specified on the address pins (A_0 through A_{16}).

Reading from the device is accomplished by taking Chip Enable (\overline{CE}) and Output Enable (\overline{OE}) LOW while forcing the Write Enable (\overline{WE}) HIGH. If Byte Low Enable (\overline{BLE}) is LOW, then data from the memory location specified by the address pins will appear on I/O_0 to I/O_7 . If Byte High Enable (\overline{BHE}) is LOW, then data from memory will appear on I/O_8 to I/O_{15} . See the truth table at the back of this data sheet for a complete description of read and write modes.

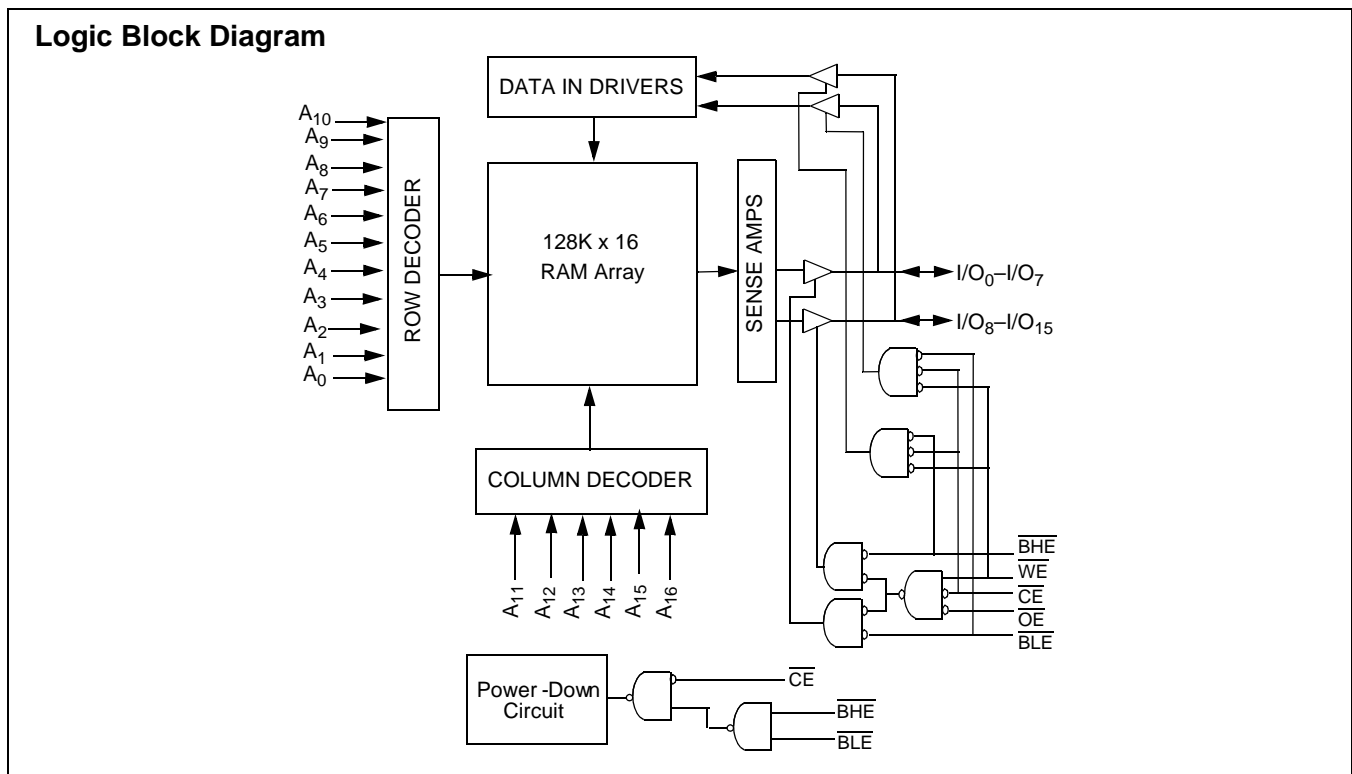

Note:

1. For best practice recommendations, please refer to the Cypress application note "System Design Guidelines" on <http://www.cypress.com>.

Product Portfolio

Product	Range	V _{CC} Range (V)			Speed (ns)	Power Dissipation					
						Operating, I _{CC} (mA)				Standby, I _{SB2} (μA)	
		Min.	Typ. ^[2]	Max.		f = 1 MHz		f = f _{Max}			
						Typ. ^[2]	Max.	Typ. ^[2]	Max.	Typ. ^[2]	Max.
CY62137CV30LL	Industrial	2.7	3.0	3.3	55	1.5	3	7	15	2	10
					70	1.5	3	5.5	12		
CY62137CV30LL	Automotive	2.7	3.0	3.3	70	1.5	3	5.5	15	2	15
CY62137CV33LL	Industrial	3.0	3.3	3.6	55	1.5	3	7	15	5	15
CY62137CVSL	Industrial	2.7	3.3	3.6	70	1.5	3	5.5	12	1	5

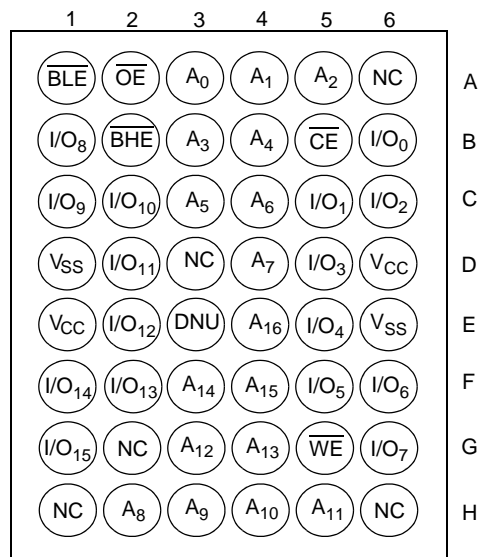
Pin Configuration^[3, 4]
48-ball VFBGA
Top View

Notes:

- Typical values are included for reference only and are not guaranteed or tested. Typical values are measured at V_{CC} = V_{CC(typ.)}, T_A = 25°C.
- NC pins are not connected to the die.
- E3 (DNU) pin have to be left floating or tied to V_{SS} to ensure proper operation.



Maximum Ratings

(Above which the useful life may be impaired. For user guidelines, not tested.)

- Storage Temperature -65°C to +150°C
- Ambient Temperature with Power Applied..... -55°C to +125°C
- Supply Voltage to Ground Potential -0.5V to $V_{CC(max)}$ + 0.5V
- DC Voltage Applied to Outputs in High-Z State^[5] -0.5V to V_{CC} + 0.3V
- DC Input Voltage^[5]..... -0.5V to V_{CC} + 0.3V
- Output Current into Outputs (LOW) 20 mA

Static Discharge Voltage..... > 2001V (per MIL-STD-883, Method 3015)

Latch-up Current..... > 200 mA

Operating Range

Device	Range	Ambient Temperature T_A	V_{CC}
CY62137CV30	Industrial	-40°C to +85°C	2.7V to 3.3V
CY62137CV33			3.0V to 3.6V
CY62137CV			2.7V to 3.6V
CY62137CV30	Automotive	-40°C to +125°C	2.7V to 3.3V

Electrical Characteristics Over the Operating Range

Parameter	Description	Test Conditions	CY62137CV30-55			CY62137CV30-70			Unit		
			Min.	Typ. ^[2]	Max.	Min.	Typ. ^[2]	Max.			
V_{OH}	Output HIGH Voltage	$I_{OH} = -1.0$ mA $V_{CC} = 2.7V$	2.4			2.4			V		
V_{OL}	Output LOW Voltage	$I_{OL} = 2.1$ mA $V_{CC} = 2.7V$			0.4			0.4	V		
V_{IH}	Input HIGH Voltage		2.2		$V_{CC} + 0.3$	2.2		$V_{CC} + 0.3$	V		
V_{IL}	Input LOW Voltage		-0.3		0.8	-0.3		0.8	V		
I_{IX}	Input Leakage Current	$GND \leq V_I \leq V_{CC}$	Ind'l	-1	+1	-1		+1	μA		
			Auto			-2		+2			
I_{OZ}	Output Leakage Current	$GND \leq V_O \leq V_{CC}$, Output Disabled	Ind'l	-1	+1	-1		+1	μA		
			Auto			-2		+2			
I_{CC}	V_{CC} Operating Supply Current	$f = f_{Max} = 1/t_{RC}$	$V_{CC} = 3.3V$ $I_{OUT} = 0mA$ CMOS Levels	Ind'l		7	15		5.5	12	mA
				Auto					5.5	15	
		$f = 1$ MHz	Ind'l		1.5	3		1.5	3		
			Auto					1.5	3		
I_{SB1}	Automatic CE Power-down Current — CMOS Inputs	$\overline{CE} \geq V_{CC} - 0.2V$ $V_{IN} \geq V_{CC} - 0.2V$ or $V_{IN} \leq 0.2V$, $f = f_{Max}$ (Address and Data only), $f=0$ (\overline{OE} , \overline{WE} , \overline{BHE} and \overline{BLE})	Ind'l		2	10		2	10	μA	
			Auto					2	15		
I_{SB2}	Automatic CE Power-down Current — CMOS Inputs	$\overline{CE} \geq V_{CC} - 0.2V$ $V_{IN} \geq V_{CC} - 0.2V$ or $V_{IN} \leq 0.2V$ $f = 0, V_{CC} = 3.3V$	Ind'l		2	10		2	10	μA	
			Auto					2	15		

Note:

5. $V_{IL(min.)} = -2.0V$ for pulse durations less than 20 ns.

Electrical Characteristics Over the Operating Range (continued)

Parameter	Description	Test Conditions	CY62137CV33-55			CY62137CV-70			Unit	
			Min.	Typ. ^[2]	Max.	Min.	Typ. ^[2]	Max.		
V _{OH}	Output HIGH Voltage	I _{OH} = -1.0 mA	V _{CC} = 3.0V	2.4			2.4		V	
			V _{CC} = 2.7V				2.4		V	
V _{OL}	Output LOW Voltage	I _{OL} = 2.1 mA	V _{CC} = 3.0V			0.4		0.4	V	
			V _{CC} = 2.7V					0.4	V	
V _{IH}	Input HIGH Voltage		2.2		V _{CC} +0.3	2.2		V _{CC} +0.3	V	
V _{IL}	Input LOW Voltage		-0.3		0.8	-0.3		0.8	V	
I _{IX}	Input Leakage Current	GND ≤ V _I ≤ V _{CC}	-1		+1	-1		+1	μA	
I _{OZ}	Output Leakage Current	GND ≤ V _O ≤ V _{CC} , Output Disabled	-1		+1	-1		+1	μA	
I _{CC}	V _{CC} Operating Supply Current	f = f _{Max} = 1/t _{RC}	V _{CC} = 3.6V		7	15		5.5	12	mA
		f = 1 MHz	I _{OUT} = 0 mA CMOS Levels		1.5	3		1.5	3	
I _{SB1}	Automatic CE Power-down Current —CMOS Inputs	$\overline{CE} \geq V_{CC} - 0.2V$ $V_{IN} \geq V_{CC} - 0.2V$ or $V_{IN} \leq 0.2V$, $f = f_{Max}$ (Address and Data Only), $f=0$ (OE, WE, BHE, and BLE)		5	15		5	15	μA	
I _{SB2}	Automatic CE Power-down Current —CMOS Inputs	$\overline{CE} \geq V_{CC} - 0.2V$ $V_{IN} \geq V_{CC} - 0.2V$ or $V_{IN} \leq 0.2V, f = 0, V_{CC} = 3.6V$	LL		5	15		5	15	μA
			SL		5	15		1	5	

Capacitance^[6]

Parameter	Description	Test Conditions	Max.	Unit
C _{IN}	Input Capacitance	T _A = 25°C, f = 1 MHz, V _{CC} = V _{CC} (typ.)	6	pF
C _{OUT}	Output Capacitance		8	pF

Thermal Resistance^[6]

Parameter	Description	Test Conditions	FBGA	Unit
θ _{JA}	Thermal Resistance (Junction to Ambient)	Still Air, soldered on a 3 x 4.5 inch, 2-layer printed circuit board	55	°C/W
θ _{JC}	Thermal Resistance (Junction to Case)		16	°C/W

Note:

6. Tested initially and after any design or process changes that may affect these parameters.

AC Test Loads and Waveforms

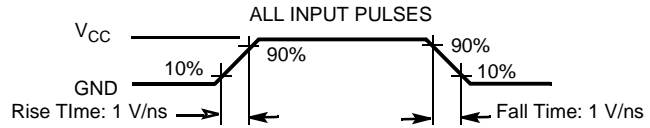
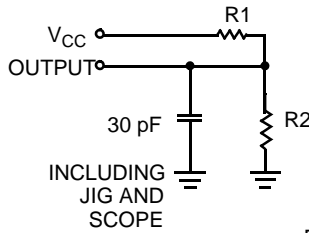

Equivalent to: THEVENIN EQUIVALENT

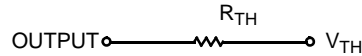

Parameters	3.0V	3.3V	Unit
R1	1105	1216	Ω
R2	1550	1374	Ω
R _{TH}	645	645	Ω
V _{TH}	1.75	1.75	V

Data Retention Characteristics (Over the Operating Range)

Parameter	Description	Conditions	Min.	Typ. ^[4]	Max.	Unit
V _{DR}	V _{CC} for Data Retention		1.5		V _{CC(max)}	V
I _{CCDR}	Data Retention Current	V _{CC} = 1.5V CE ≥ V _{CC} - 0.2V, V _{IN} ≥ V _{CC} - 0.2V or V _{IN} ≤ 0.2V		1	6	μ A
		LL	Ind'l		8	
		SL	Ind'l		4	
t _{CDR} ^[6]	Chip Deselect to Data Retention Time		0			ns
t _R ^[7]	Operation Recovery Time		t _{RC}			ns

Data Retention Waveform^[8]

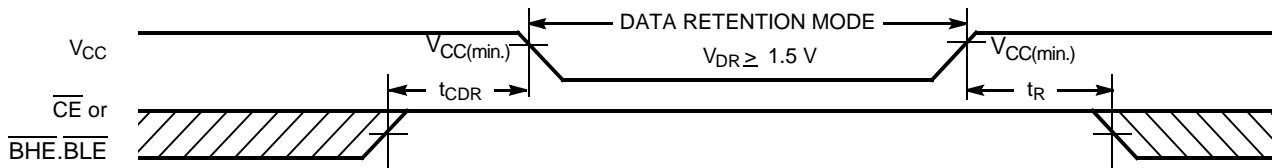

Notes:

7. Full-device AC operation requires linear V_{CC} ramp from V_{DR} to V_{CC(min.)} > 100 μ s or stable at V_{CC(min.)} > 100 μ s.
8. BHE.BLE is the AND of both BHE and BLE. Chip can be deselected by either disabling the chip enable signals or by disabling both $\overline{\text{BHE}}$ and $\overline{\text{BLE}}$.

Switching Characteristics Over the Operating Range^[9]

Parameter	Description	55 ns		70 ns		Unit
		Min.	Max.	Min.	Max.	
Read Cycle						
t _{RC}	Read Cycle Time	55		70		ns
t _{AA}	Address to Data Valid		55		70	ns
t _{OHA}	Data Hold from Address Change	10		10		ns
t _{ACE}	\overline{CE} LOW to Data Valid		55		70	ns
t _{DOE}	\overline{OE} LOW to Data Valid		25		35	ns
t _{LZOE}	\overline{OE} LOW to Low-Z ^[10]	5		5		ns
t _{HZOE}	\overline{OE} HIGH to High-Z ^[10, 12]		20		25	ns
t _{LZCE}	\overline{CE} LOW to Low-Z ^[10]	10		10		ns
t _{HZCE}	\overline{CE} HIGH to High-Z ^[10, 12]		20		25	ns
t _{PU}	\overline{CE} LOW to Power-up	0		0		ns
t _{PD}	\overline{CE} HIGH to Power-down		55		70	ns
t _{DBE}	$\overline{BHE}/\overline{BLE}$ LOW to Data Valid		55		70	ns
t _{LZBE} ^[11]	$\overline{BHE}/\overline{BLE}$ LOW to Low-Z ^[10]	5		5		ns
t _{HZBE}	$\overline{BHE}/\overline{BLE}$ HIGH to High-Z ^[10, 12]		20		25	ns
Write Cycle^[13]						
t _{WC}	Write Cycle Time	55		70		ns
t _{SCE}	\overline{CE} LOW to Write End	45		60		ns
t _{AW}	Address Set-up to Write End	45		60		ns
t _{HA}	Address Hold from Write End	0		0		ns
t _{SA}	Address Set-up to Write Start	0		0		ns
t _{PWE}	\overline{WE} Pulse Width	40		45		ns
t _{BW}	$\overline{BHE}/\overline{BLE}$ Pulse Width	50		60		ns
t _{SD}	Data Set-up to Write End	25		30		ns
t _{HD}	Data Hold from Write End	0		0		ns
t _{HZWE}	\overline{WE} LOW to High-Z ^[10, 12]		20		25	ns
t _{LZWE}	\overline{WE} HIGH to Low-Z ^[10]	10		10		ns

Notes:

9. Test conditions assume signal transition time of 5 ns or less, timing reference levels of $V_{CC(typ.)}/2$, input pulse levels of 0 to $V_{CC(typ.)}$, and output loading of the specified I_{OL}/I_{OH} and 30 pF load capacitance.
10. At any given temperature and voltage condition, t_{HZCE} is less than t_{LZCE}, t_{HZBE} is less than t_{LZBE}, t_{HZOE} is less than t_{LZOE}, and t_{HZWE} is less than t_{LZWE} for any given device.
11. If both byte enables are toggled together this value is 10 ns.
12. t_{HZOE}, t_{HZCE}, t_{HZBE}, and t_{HZWE} transitions are measured when the outputs enter a high impedance state.
13. The internal write time of the memory is defined by the overlap of \overline{WE} , $\overline{CE} = V_{IL}$, \overline{BHE} and/or $\overline{BLE} = V_{IL}$. All signals must be ACTIVE to initiate a write and any of these signals can terminate a write by going INACTIVE. The data input set-up and hold timing should be referenced to the edge of the signal that terminates the write.

Switching Waveforms

Read Cycle No. 1 (Address Transition Controlled)^[14, 15]

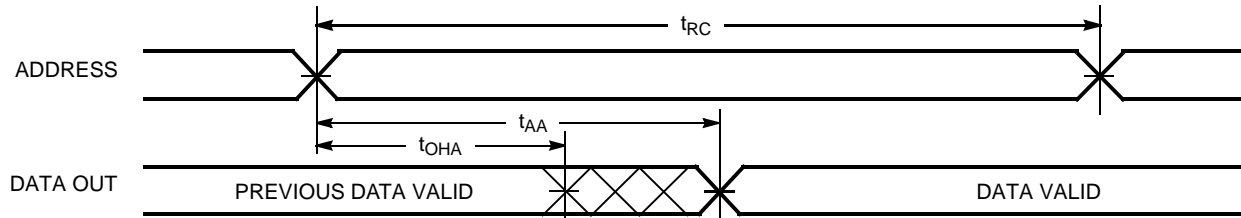

Read Cycle No. 2 ($\overline{\text{OE}}$ Controlled)^[15, 16]

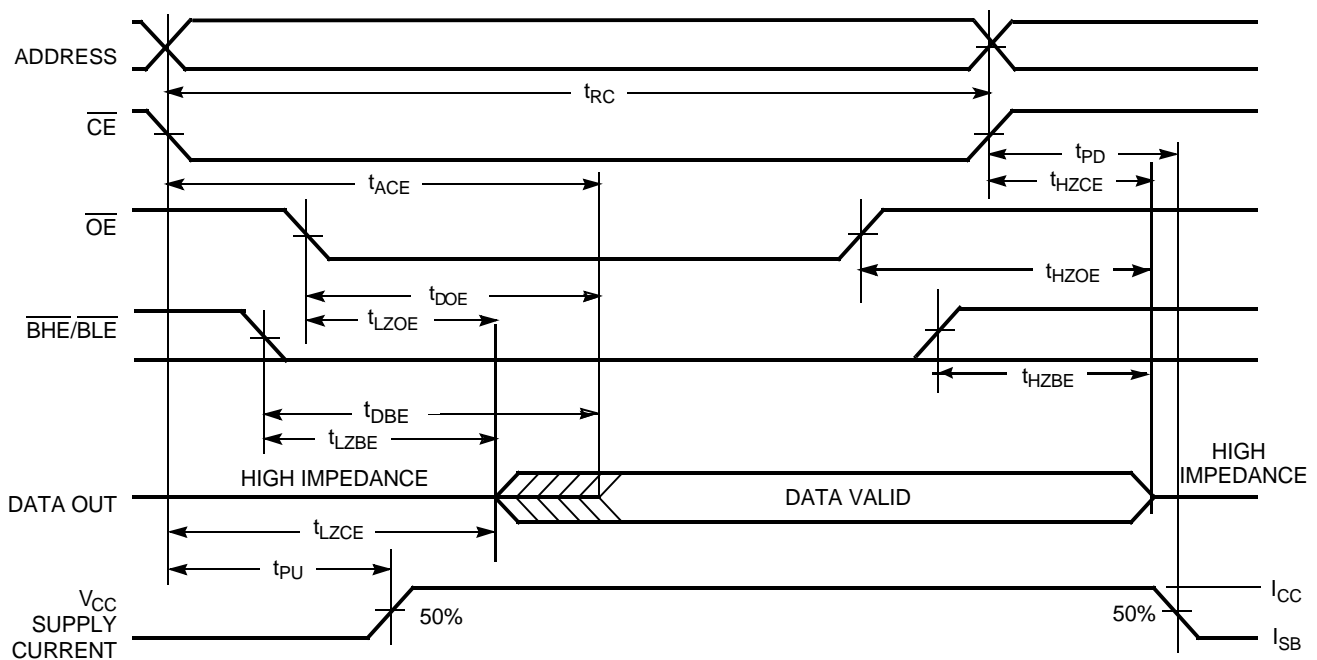

Notes:

- 14. Device is continuously selected. $\overline{\text{OE}}, \overline{\text{CE}} = V_{\text{IL}}, \overline{\text{BHE}}, \overline{\text{BLE}} = V_{\text{IL}}$.
- 15. $\overline{\text{WE}}$ is HIGH for read cycle.
- 16. Address valid prior to or coincident with $\overline{\text{CE}}, \overline{\text{BHE}}, \overline{\text{BLE}}$ transition LOW.

Switching Waveforms (continued)

Write Cycle No. 1 (WE Controlled)^[13, 17, 18]

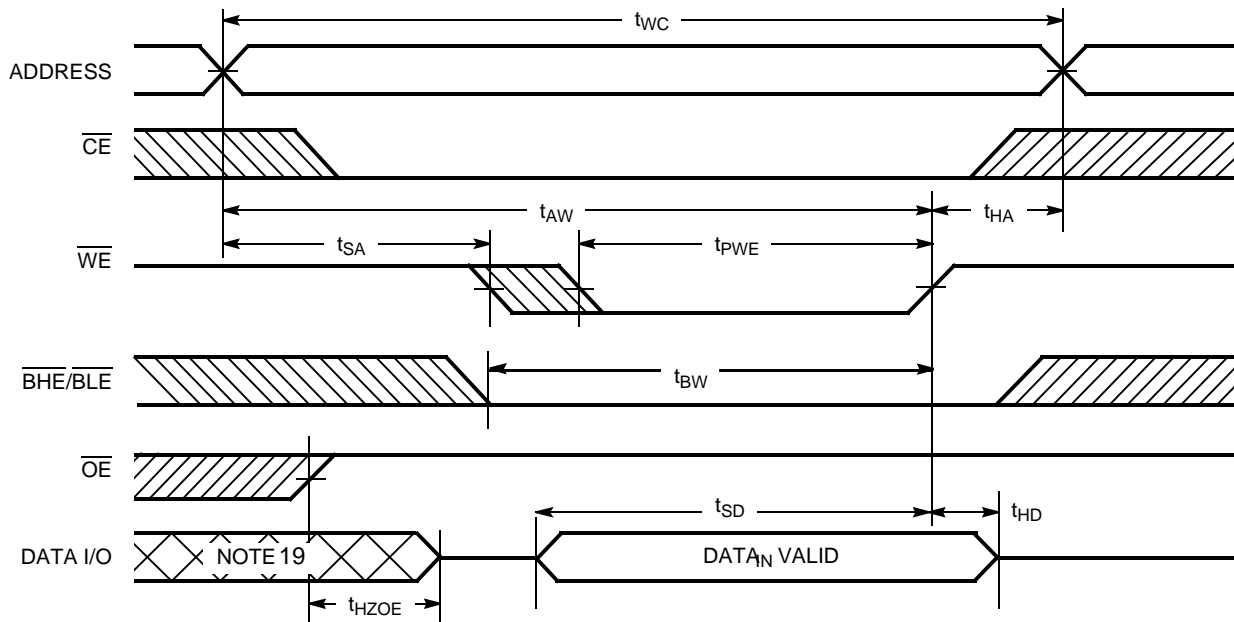

Write Cycle No. 2 (CE Controlled)^[13, 17, 18]

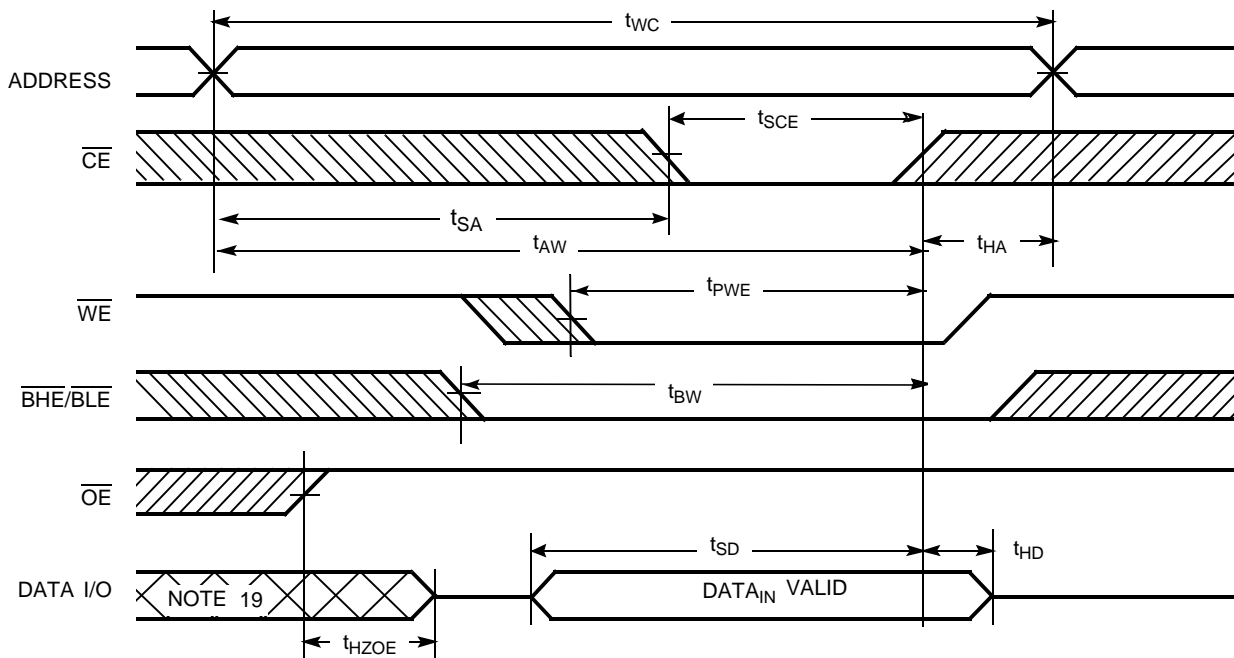

Notes:

- 17. Data I/O is high-impedance if $\overline{OE} = V_{IH}$.
- 18. If CE goes HIGH simultaneously with WE HIGH, the output remains in a high-impedance state.
- 19. During this period, the I/Os are in output state and input signals should not be applied.

Switching Waveforms (continued)

Write Cycle No. 3 (\overline{WE} Controlled, \overline{OE} LOW)^[18]

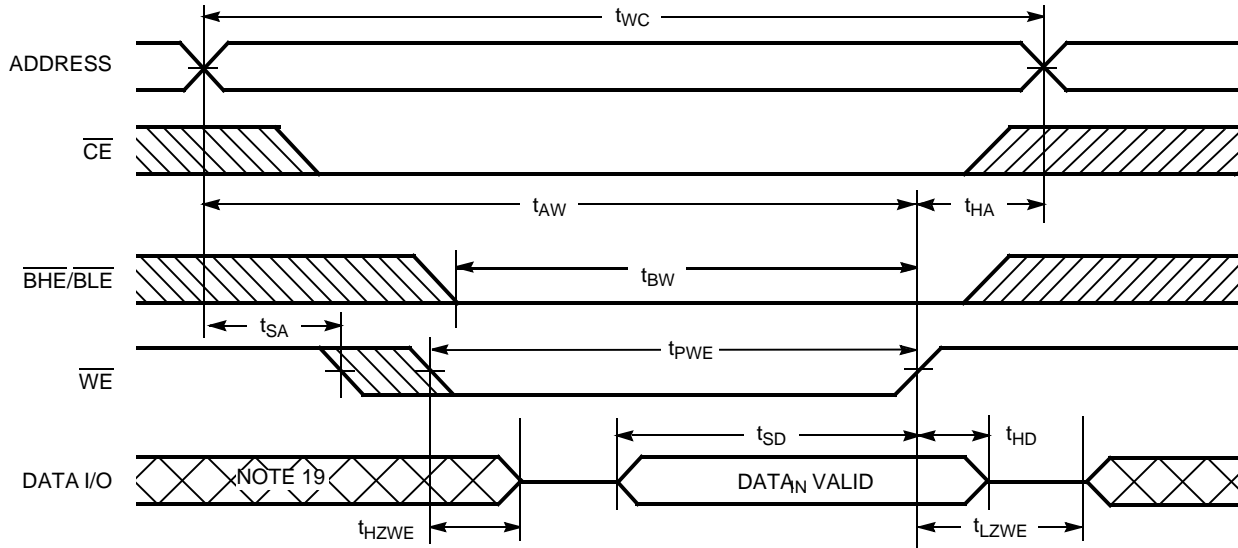

Write Cycle No. 4 ($\overline{BHE}/\overline{BLE}$ Controlled, \overline{OE} LOW)^[18]

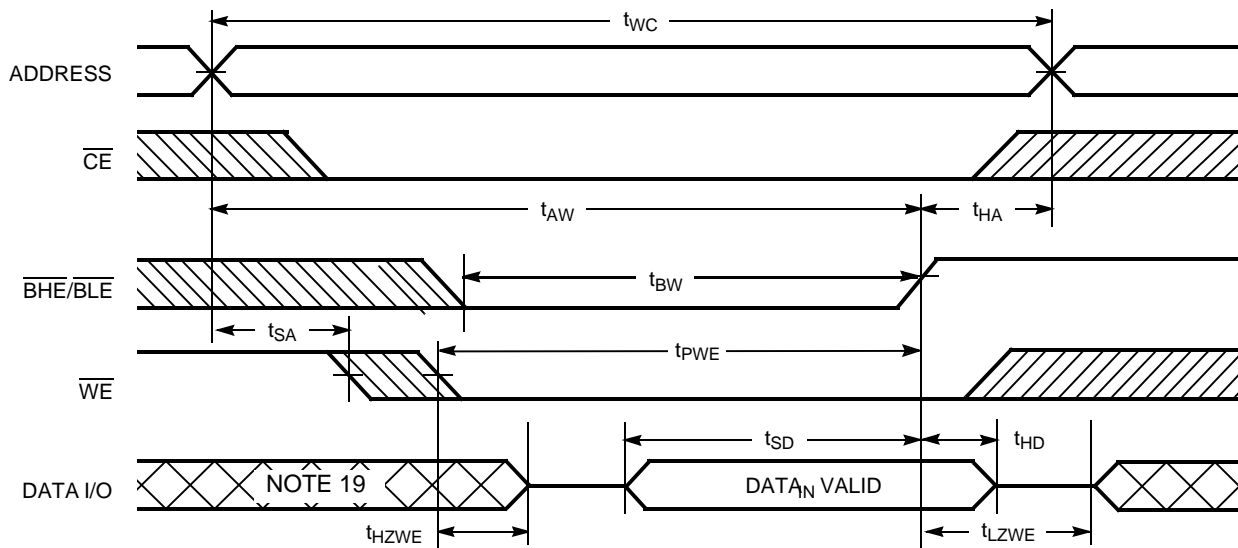

Truth Table

$\overline{\text{CE}}$	$\overline{\text{WE}}$	$\overline{\text{OE}}$	$\overline{\text{BHE}}$	$\overline{\text{BLE}}$	Inputs/Outputs	Mode	Power
H	X	X	X	X	High-Z	Deselect/Power-down	Standby (I_{SB})
X	X	X	H	H	High-Z	Deselect/Power-down	Standby (I_{SB})
L	H	L	L	L	Data Out (I/O_0 – I/O_{15})	Read	Active (I_{CC})
L	H	L	H	L	High Z (I/O_8 – I/O_{15}); Data Out (I/O_0 – I/O_7)	Read	Active (I_{CC})
L	H	L	L	H	Data Out (I/O_8 – I/O_{15}); High Z (I/O_0 – I/O_7)	Read	Active (I_{CC})
L	L	X	L	L	Data In (I/O_0 – I/O_{15})	Write	Active (I_{CC})
L	L	X	H	L	High Z (I/O_8 – I/O_{15}); Data In (I/O_0 – I/O_7)	Write	Active (I_{CC})
L	L	X	L	H	Data in (I/O_8 – I/O_{15}); High Z (I/O_0 – I/O_7)	Write	Active (I_{CC})
L	H	H	L	L	High-Z	Output Disabled	Active (I_{CC})
L	H	H	H	L	High-Z	Output Disabled	Active (I_{CC})
L	H	H	L	H	High-Z	Output Disabled	Active (I_{CC})

Ordering Information

Speed (ns)	Ordering Code	Package Diagram	Package Type	Operating Range
55	CY62137CV30LL-55BVI	51-85150	48-ball FBGA (6 x 8 x 1 mm)	Industrial
	CY62137CV30LL-55BVXI		48-ball FBGA (6 x 8 x 1 mm) (Pb-free)	
	CY62137CV33LL-55BVI		48-ball FBGA (6 x 8 x 1 mm)	
70	CY62137CV30LL-70BAI	51-85096	48-ball FBGA (7 x 7 x 1.2 mm)	Industrial
	CY62137CV30LL-70BVI	51-85150	48-ball FBGA (6 x 8 x 1 mm)	
	CY62137CVSL-70BAI	51-85096	48-ball FBGA (7 x 7 x 1.2 mm)	
	CY62137CVSL-70BAXI		48-ball FBGA (7 x 7 x 1.2 mm) (Pb-free)	
	CY62137CV30LL-70BAE	51-85096	48-ball FBGA (7 x 7 x 1.2 mm)	Automotive
	CY62137CV30LL-70BVE	51-85150	48-ball FBGA (6 x 8 x 1 mm)	
	CY62137CV30LL-70BVXE		48-ball FBGA (6 x 8 x 1 mm) (Pb-free)	

Please contact your local Cypress sales representative for availability of these parts

Package Diagrams

48-ball FBGA (7 x 7 x 1.2 mm) (51-85096)

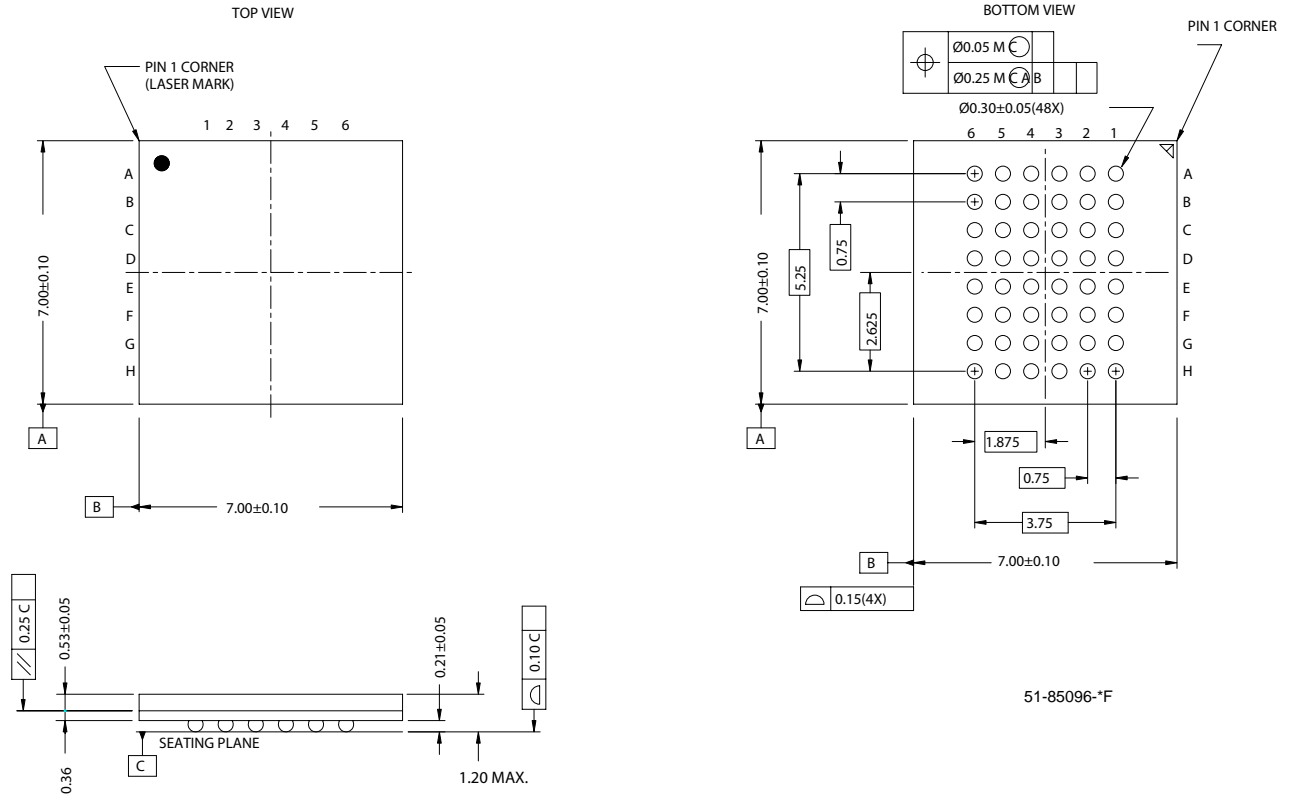

Package Diagrams (continued)

48-ball VFBGA (6 x 8 x 1 mm) (51-85150)

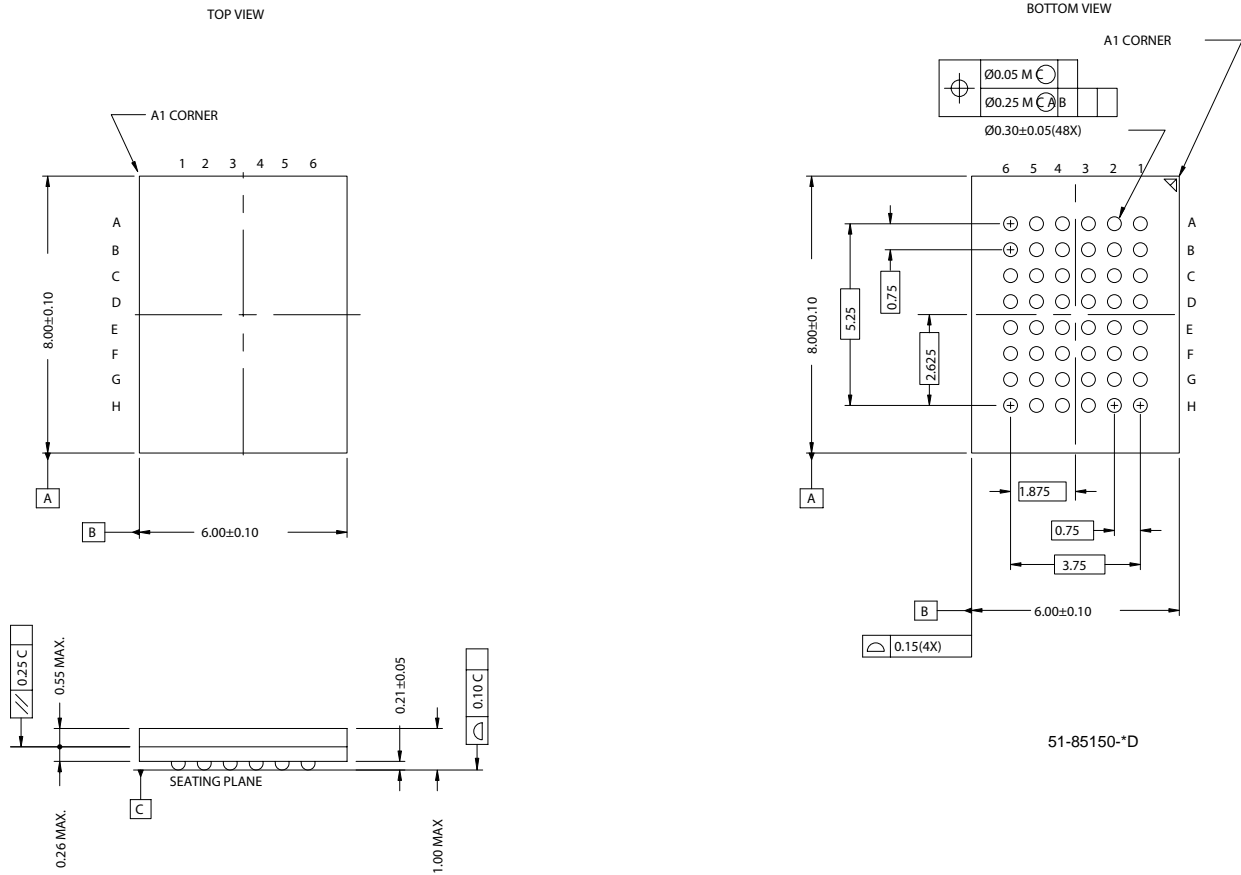

51-85150-D

MoBL is a registered trademark and More Battery Life is a trademark of Cypress Semiconductor Corporation. All product and company names mentioned in this document may be the trademarks of their respective holders.

Document History Page

Document Title: CY62137CV30/33 MoBL® and CY62137CV MoBL® 2-Mbit (128K x 16) Static RAM				
Document Number: 38-05201				
REV.	ECN NO.	Issue Date	Orig. of Change	Description of Change
**	112393	02/19/02	GAV	New Data Sheet (advance information)
*A	114015	04/25/02	JUI	Added BV package diagram Changed from Advance Information to Preliminary
*B	117064	07/12/02	MGN	Changed from Preliminary to Final
*C	118122	09/10/02	MGN	Added new part number: CY62137CV with wider voltage (2.7V – 3.6V) Added new SL power bin for new part number For T _{AA} = 55 ns, improved t _{PWE} min. from 45 ns to 40 ns For T _{AA} = 70 ns, improved t _{PWE} min. from 50 ns to 45 ns For T _{AA} = 70 ns, improved t _{LZWE} min. from 5 ns to 10 ns
*D	118761	09/23/02	MGN	Improved Typ. I _{CC} spec to 7 mA (for 55 ns) and 5.5 mA (for 70 ns) Improved Max I _{CC} spec to 15 mA (for 55 ns) and 12 mA (for 70 ns) For T _{AA} = 55 ns, improved t _{LZWE} min. from 5 ns to 10 ns Changed upper spec. for Supply Voltage to Ground Potential to V _{CC(max)} + 0.5V Changed upper spec. for DC Voltage Applied to Outputs in High-Z State and DC Input Voltage to V _{CC} + 0.3V
*E	343877	See ECN	PCI	Added Automotive Information in Operating Range, DC and Ordering Information Table
*F	419237	See ECN	ZSD	Changed the address of Cypress Semiconductor Corporation on Page #1 from "3901 North First Street" to "198 Champion Court" Updated the ordering information table and replaced the Package name column with Package diagram
*G	486789	See ECN	VKN	Removed part number CY62137CV25 from the product offering Updated the ordering information table